

STATE OF OHIO
DEPARTMENT OF TRANSPORTATION

STA-153/173-7.47/0.00
NIMISHILLEN, MARLBORO, WASHINGTON
AND LEXINGTON TOWNSHIPS
STARK COUNTY

PROJECT DESCRIPTION
MINOR REHAB-RESURFACING OF 2.4 MILES OF SR 153
AND 4.6 MILES OF SR 173 IN STARK COUNTY,
INCLUDING MINOR REPAIRS TO BRIDGE STA-173-0425.

PROJECT EARTH DISTURBED AREA: 0.04 ACRES
ESTIMATED CONTRACTOR EDA: N/A (MAINTENANCE PROJECT)
NOTICE OF INTENT EDA: N/A (MAINTENANCE PROJECT)

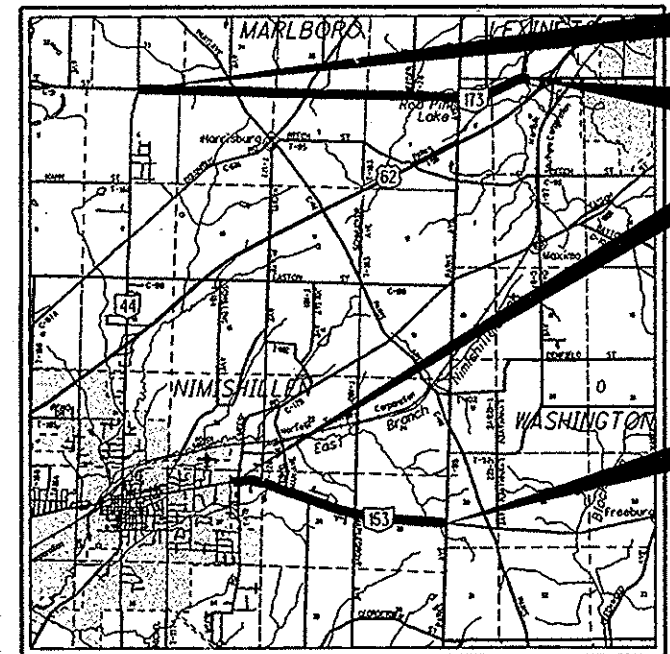

LOCATION MAP

LATITUDE: N40°52'12" LONGITUDE: W81°12'35"

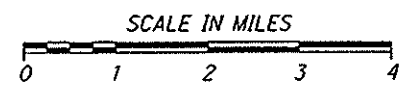

PORTION TO BE IMPROVED _____
INTERSTATE & DIVIDED HIGHWAY _____
UNDIVIDED STATE & FEDERAL ROUTES _____
OTHER ROADS _____

INDEX OF SHEETS:

TITLE SHEET	1
TYPICAL SECTIONS	2
GENERAL NOTES	3-4, 4A
MAINTENANCE OF TRAFFIC	5-9
GENERAL SUMMARY	10, 10A
ASPHALT CONCRETE SHEET	11
TRAFFIC CONTROL	12-19
STRUCTURES	20-23

2005 SPECIFICATIONS
THE STANDARD SPECIFICATIONS OF THE STATE OF OHIO, DEPARTMENT OF TRANSPORTATION, INCLUDING CHANGES AND SUPPLEMENTAL SPECIFICATIONS LISTED IN THE PROPOSAL SHALL GOVERN THIS IMPROVEMENT.

I HEREBY APPROVE THESE PLANS AND DECLARE THAT THE MAKING OF THIS IMPROVEMENT WILL REQUIRE THE CLOSING TO TRAFFIC OF THE HIGHWAY AND THAT DE-TOURS WILL BE PROVIDED AS INDICATED ON SHEETS 7-8.

DESIGN FUNCTIONAL CLASSIFICATION:
SR 153 - RURAL MINOR ARTERIAL
SR 173 - RURAL MAJOR COLLECTOR
NHS PROJECT _____ NO

DESIGN EXCEPTIONS
NONE

UNDERGROUND UTILITIES
CONTACT BOTH SERVICES
CALL TWO WORKING DAYS
BEFORE YOU DIG

CALL
1-800-362-2764
(TOLL FREE)

OHIO UTILITIES PROTECTION SERVICE
NON-MEMBERS
MUST BE CALLED DIRECTLY

OIL & GAS PRODUCERS PROTECTIVE
SERVICE CALL: 1-800-925-0988

PLAN PREPARED BY:
OHIO DEPARTMENT OF TRANSPORTATION
DISTRICT 4
OFFICE OF PRODUCTION
2088 SOUTH ARLINGTON ROAD
AKRON, OHIO 44306

ENGINEERS SEAL:

SIGNED: *Thomas Powell*
DATE: 02-14-08

STANDARD CONSTRUCTION DRAWINGS				SUPPLEMENTAL SPECIFICATIONS	
BP-3.1	10/19/07	MT-105.10	10/18/02	800	1/18/08
BP-4.1	7/16/04	MT-105.11	10/18/02	832	4/25/06
				843	4/18/03
				848	4/15/05
DM-4.3	7/19/02	TC-41.20	1/19/01		
DM-4.4	7/19/02	TC-42.20	7/16/04		
		TC-52.10	1/19/07		
GR-1.1	7/16/04	TC-52.20	1/19/07		
GR-2.1	1/16/04	TC-65.10	1/21/05		
		TC-65.11	1/21/05		
AS-1-81	7/19/02	TC-71.10	1/19/07		
		TC-73.10	1/19/01		
MT-35.10	4/20/01				
MT-97.10	9/05/06				
MT-97.11	9/05/06				
MT-99.20m	1/30/95				
MT-101.60	9/20/06				

APPROVED: *E. M. Gettli*
DATE: 2-11-08 DISTRICT DEPUTY DIRECTOR

APPROVED: *James A. Beasley III*
DATE: 2-29-08 DIRECTOR, DEPARTMENT OF TRANSPORTATION

STA - SR-153/173-7.47/0.00
080343 PID - 25581
Dist 4 5/21/2008

I:\Projects\STA-153_0747_25581\roadway\sheets\25

FEDERAL PROJECT NO. E071(154)
PID NO. 25581
CONSTRUCTION PROJECT NO. NONE
RAILROAD INVOLVEMENT NONE
STA-153/173-7.47/0.00
23

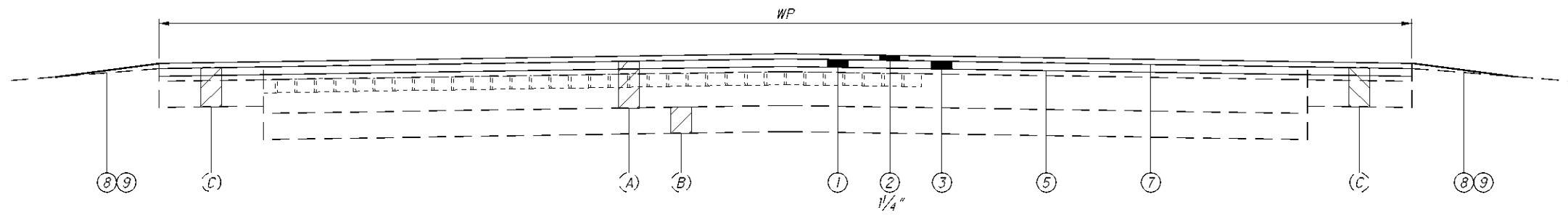

ROUTE	SLM		WP Avg. (Feet)	LENGTH (Miles)
	FROM	TO		
SR 153	7.47	9.87	29	2.40

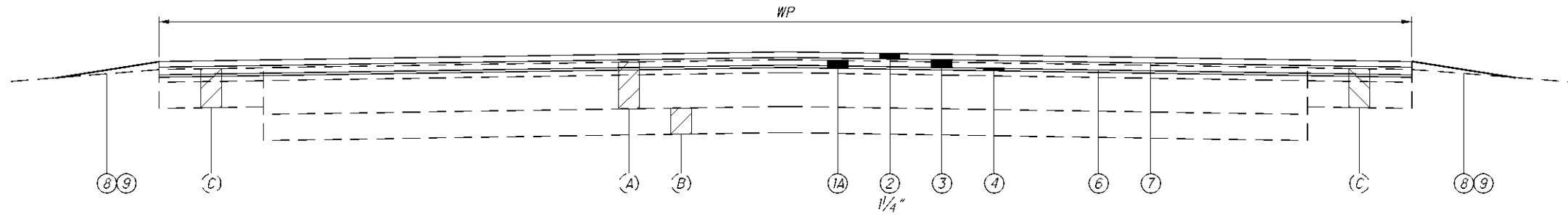

ROUTE	SLM		WP Avg. (Feet)	LENGTH (Miles)
	FROM	TO		
SR 173	0.00	1.72	25	1.72

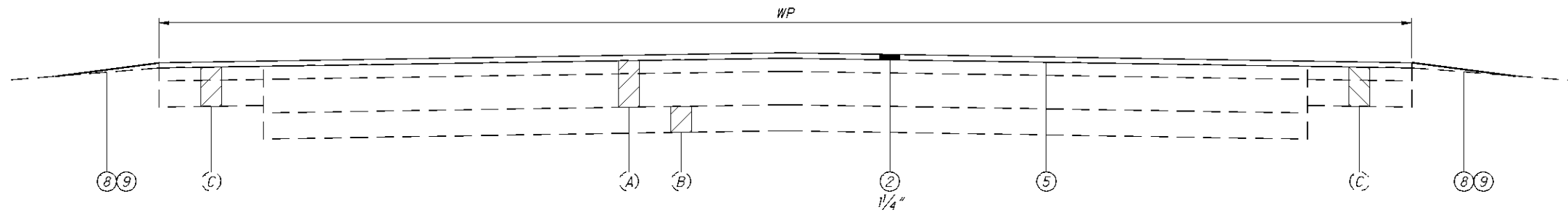

ROUTE	SLM		WP Avg. (Feet)	LENGTH (Miles)
	FROM	TO		
SR 173	1.72	1.98	32	0.26

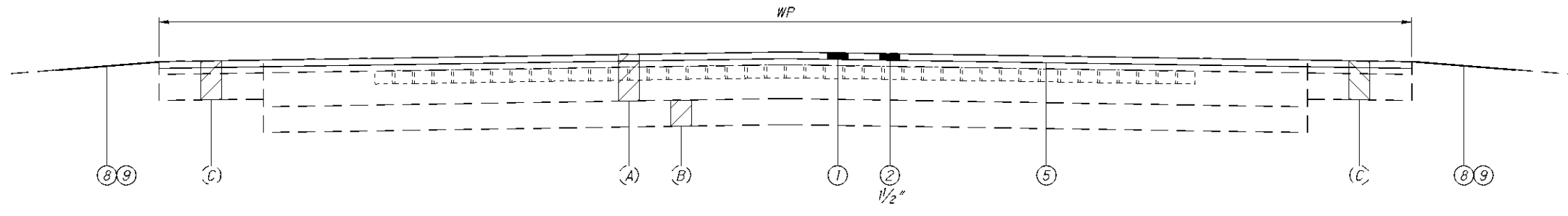

ROUTE	SLM		WP Avg. (Feet)	LENGTH (Miles)
	FROM	TO		
SR 173	1.98	4.32	32	2.34

LEGEND

- ① 254, 1/2" PAVEMENT PLANING, ASPHALT CONCRETE, AS PER PLAN
- ①A 254, 1/2" PAVEMENT PLANING, ASPHALT CONCRETE
- ② 446, ASPHALT CONCRETE SURFACE COURSE, TYPE 1, PG70-22M
- ③ 446, 1 3/4" ASPHALT CONCRETE INTERMEDIATE COURSE TYPE 2, PG64-22
- ④ 422, SINGLE CHIP SEAL, AS PER PLAN
- ⑤ 407, TACK COAT
- ⑥ 407, TACK COAT FOR INTERMEDIATE COURSE (0.1 GAL/SY)
- ⑦ 407, TACK COAT FOR INTERMEDIATE COURSE (0.04 GAL/SY)
- ⑧ 408, PRIME COAT, AS PER PLAN
- ⑨ 617, COMPACTED AGGREGATE, AS PER PLAN

- (A) EXISTING ASPHALT OR COMPOSITE PAVEMENT
- (B) EXISTING BITUMINOUS ASPHALT BASE
- (C) EXISTING ASPHALT SHOULDER

WORK LIMITS

THE WORK LIMITS SHOWN ON THESE PLANS ARE FOR PHYSICAL CONSTRUCTION ONLY. PROVIDE THE INSTALLATION AND OPERATION OF ALL WORK ZONE TRAFFIC CONTROL AND WORK ZONE TRAFFIC CONTROL DEVICES REQUIRED BY THESE PLANS WHETHER INSIDE OR OUTSIDE THESE WORK LIMITS.

CONVERSION OF STANDARD CONSTRUCTION DRAWINGS

CONVERT THE METRIC STANDARD DRAWINGS REFERENCED IN THIS PLAN TO ENGLISH UNITS USING THE SI (METRIC) TO ENGLISH CONVERSION FACTORS PROVIDED IN SECTION 109.02 OF THE CONSTRUCTION AND MATERIAL SPECIFICATIONS.

CONVERSIONS WILL BE APPROPRIATELY PRECISE AND REFLECT STANDARD INDUSTRY ENGLISH VALUES WHERE SUITABLE.

CLEARING AND GRUBBING

ALTHOUGH THERE ARE NO TREES OR STUMPS SPECIFICALLY MARKED FOR REMOVAL WITHIN THE LIMITS OF THE PROJECT, A LUMP SUM QUANTITY IS INCLUDED IN THE GENERAL SUMMARY FOR ITEM 201, CLEARING AND GRUBBING. ALL PROVISIONS AS SET FORTH IN THE SPECIFICATIONS UNDER THIS ITEM ARE INCLUDED IN THE LUMP SUM PRICE BID FOR ITEM 201, CLEARING AND GRUBBING.

PROFILE AND ALIGNMENT

PLACE THE PROPOSED PAVEMENT TO FOLLOW THE ALIGNMENT AND PROFILE OF THE EXISTING PAVEMENT.

CONNECTION BETWEEN EXISTING AND PROPOSED GUARDRAIL

WHEN IT IS NECESSARY TO SPLICE PROPOSED GUARDRAIL TO EXISTING GUARDRAIL, ONLY THE EXISTING GUARDRAIL SHALL BE CUT, DRILLED, OR PUNCHED. THE CONNECTION SHALL BE MADE USING A "W-BEAM RAIL SPLICE" AS SHOWN IN AASHTO M 180. PAYMENT SHALL BE INCLUDED IN THE CONTRACT PRICE FOR THE RESPECTIVE GUARDRAIL ITEMS.

PAVEMENT MARKING LANE WIDTHS

THE NORMAL LANE WIDTH FOR THE PAVEMENT MARKINGS ON THIS PROJECT SHALL BE AS FOLLOWS:

ROUTE	S.L.M. TO	S.L.M.	LANE WIDTH
SR 153	7.47	9.87	12'
SR 173	0.0	1.72	10'
SR 173	1.72	4.60	12'

UTILITIES

THE CONTRACTOR SHALL USE THE FOLLOWING PROCEDURE AT EACH LOCATION WHERE WORK IS PERFORMED, IN ACCORDANCE WITH SECTIONS 105.07 AND 107.16 IN THE CONSTRUCTION AND MATERIALS SPECIFICATIONS:

THE CONTRACTOR SHALL NOTIFY THE PROJECT ENGINEER, THE OHIO UTILITIES PROTECTION SERVICE (OUPS), THE OHIO & GAS PROCEDURES UNDERGROUND PROTECTION SERVICE (OGPUPS), THE OHIO DEPARTMENT OF TRANSPORTATION DISTRICT 4 HEAD-QUARTERS AND ALL NON REGISTERED UTILITY OWNERS AT LEAST TWO (2) WORKING DAYS PRIOR TO COMMENCING CONSTRUCTION OPERATIONS IN ALL AREAS.

OUPS 1-800-362-2764 (CONTACT LIMITED BASIS PARTICIPANTS DIRECTLY)
OGPUPS 1-800-925-0988
ODOT 330-786-3145 KEN GREENE

THE LOCATION OF THE UNDERGROUND UTILITIES SHOWN ON THE PLANS ARE AS OBTAINED FROM THE OWNERS AS REQUIRED BY SECTION 153.64 O.R.C.

LISTED BELOW ARE ALL UTILITIES LOCATED WITHIN THE PROJECT CONSTRUCTION LIMITS TOGETHER WITH THEIR RESPECTIVE OWNERS:

AEP	Columbia Gas of Ohio
ATTN: Kathy A. Mossbarger	ATTN: Dan Suren
825 Tech Center Dr.	7080 Frye Road
Gahanna, OH 43230	Middleburg Heights, OH 44130
330-438-7061	440-891-2428
	440-891-2797 Fax

AT&T	Northern Industrial Energy
ATTN: Jim Buetel	Development Corp.
50 W. Bowery St., 4th Floor	Akron, OH 44308
330-384-8057	5900 Mayfair Road, NW
330-384-8879 Fax	North Canton, OH 44720
	330-498-9130
	330-498-9137 Fax

Dominion East Ohio	Ohio Edison
ATTN: Scott Hallam	ATTN: Steve Vanchoff
7015 Freedom Ave., NW	1910 W. Market Street
North Canton, OH 44720	Building 1
330-266-2041	Akron, OH 44313
330-266-2127 Fax	330-384-4750
	330-384-4723 Fax

North East Ohio Natural Gas	Stark County Metro Sewer
ATTN: Chad Wallace	District
9081 St. Rt. 250	ATTN: Jim Jones
Strasburg, OH 44680	1701 Mahoning Rd., N.E.
1-800-848-5589	Canton, OH 44705
330-878-5614 Fax	330-451-2314
	330-453-9044 Fax

Time Warner Cable	
ATTN: Tod Dean	
530 South Main St., Suite 1741	
Akron, OH 44311	
330-490-2506	
330-384-8206 Fax	

ITEM 408 - PRIME COAT, AS PER PLAN

THE CONTRACTOR WILL APPLY "MC-70" AT A RATE OF 0.4 GALLONS PER SQUARE YARD, OR AS DETERMINED BY THE ENGINEER, TO THE COMPLETED COMPACTED AGGREGATE SHOULDER.

THE CONTRACTOR SHALL PROVIDE A SHIELD TO PREVENT THE SPRAYING OR DRIFTING OF LIQUID PRIME COAT MATERIAL ONTO THE EDGE OF THE PAVEMENT OR EDGELINE. CARE ALSO SHALL BE TAKEN TO AVOID SPRAYING LIQUID PRIME COAT MATERIAL ONTO DRIVEWAY APRONS, MAILBOX APPROACHES OR ANY PEDESTRIAN AREAS. THE ATTENTION OF THE CONTRACTOR IS DIRECTED TO 107.10 OF THE SPECIFICATIONS.

ITEM 617 COMPACTED AGGREGATE, AS PER PLAN

IN LOW SHOULDER AREAS EXCEEDING 1", OR AS DIRECTED BY THE ENGINEER, RECYCLED ASPHALT PAVEMENT (RAP) SHALL BE USED IN AREAS ADJACENT TO THE PAVED BERM. THE RAP SHALL HAVE A MINIMUM PG CONTENT OF 4.5% AND MEET THE FOLLOWING GRADATION. ONCE THE STOCKPILE MEETS THE GRADATION, THE PG CONTENT OF THE RAP SHALL BE DETERMINED PER 441.03. THE RAP ANALYSIS MUST BE SUBMITTED TO THE ENGINEER FOR APPROVAL 2 WEEKS PRIOR TO USE. METHOD OF MEASUREMENT SHALL BE AS PER 617.06. PLACEMENT AND COMPACTION SHALL MEET THE REQUIREMENTS OF ITEM 617. ALL MATERIALS, LABOR, EQUIPMENT, TOOLS AND INCIDENTALS NECESSARY TO COMPLETE THE WORK SHALL BE INCLUDED IN THE UNIT PRICE BID FOR ITEM 617 COMPACTED AGGREGATE, AS PER PLAN.

MODIFIED GRADATION SHALL APPLY:

SIEVE	TOTAL PERCENT PASSING
1- 1/2"	100
3/4"	50-100
NO. 4	35-70
NO. 30	9-33
NO. 200	0-13

ITEM 254 - PAVEMENT PLANING, ASPHALT CONCRETE, AS PER PLAN

THIS ITEM OF WORK SHALL BE PERFORMED IN CONFORMANCE WITH ITEM 254 IN THE CMS EXCEPT THE DEPTH SHALL VARY FROM 1/2" TO THE TOP OF THE BRICK WHICHEVER IS FIRST. THIS WORK SHALL BE PERFORMED SO THAT THE BRICK BASE IS NOT DISTURBED. ALL EQUIPMENT, LABOR, TOOLS, AND OTHER INCIDENTALS REQUIRED TO PERFORM THIS WORK SHALL BE INCLUDED IN THE UNIT BID PRICE FOR ITEM 254 PAVEMENT PLANING, ASPHALT CONCRETE, AS PER PLAN.

ITEM 646 - EPOXY PAVEMENT MARKING, AS PER PLAN

THE EPOXY PAVEMENT MARKING MATERIAL FURNISHED UNDER THESE ITEMS SHALL BE EPOPLEX LS-60 AS FURNISHED BY EPOPLEX, MAPLE SHADE, NEW JERSEY.

ITEM 646- EPOXY PAVEMENT MARKING - (POLYCARB) - ALTERNATE BID

THE EPOXY PAVEMENT MARKING MATERIAL SHALL BE MARK 55.4 AS FURNISHED BY POLYCARB, CLEVELAND, OHIO PAYMENT WILL BE AT THE NORMAL CONTRACT PRICE AS SPECIFIED IN ITEM 646.

BRIDGE PAVEMENT MARKINGS

THE BRIDGE DECKS WITHIN PROJECT LIMITS SHALL BE INCLUDED FOR THE STRIPING ON THIS PROJECT. THIS INCLUDES THE REMOVAL OF EXISTING EPOXY MARKINGS AND THE RE-APPLICATION OF EPOXY MARKINGS FOR ALL BRIDGE DECKS WITHIN THE LIMITS.

ITEM 604 - MONUMENT BOX ADJUSTED TO GRADE

THERE ARE 16 LOCATIONS BETWEEN SLM 7.47 AND SLM 9.87 WHERE EXISTING MONUMENT BOXES ARE TO BE ADJUSTED TO GRADE WITHIN THE PROJECT LIMITS OF SR 153. THERE ARE 7 LOCATIONS BETWEEN SLM 0.00 AND SLM 1.98 WHERE EXISTING MONUMENT BOXES ARE TO BE ADJUSTED TO GRADE WITHIN THE PROJECT LIMITS OF SR 173.

THE FOLLOWING QUANTITY HAS BEEN CARRIED TO THE GENERAL SUMMARY:

604, MONUMENT BOX ADJUSTED TO GRADE 23 EACH

ITEM 254 - PAVEMENT PLANING, PORTLAND CEMENT CONCRETE

THERE IS A 20' BY 25' CONCRETE PATCH AT SR 173 SLM 0.54 TO BE PLANED 1/2" USING THE FOLLOWING QUANTITY.

THE FOLLOWING QUANTITY HAS BEEN CARRIED TO THE GENERAL SUMMARY:

254, PAVEMENT PLANING, PORTLAND CEMENT CONCRETE 56 SQ YD

I:\Projects\STA\25581_153_074\roadway\sheets\25581GN001.dgn 19-MAR-2008 1:05PM rbaughma

CALCULATED
RCB
CHECKED
TJP

GENERAL NOTES

STA - 153 / 173 - 7.47 / 0.00

3
23

ITEM 251 - PARTIAL DEPTH PAVEMENT REPAIR

A QUANTITY OF THIS ITEM SHALL BE PROVIDED FOR USE AS DIRECTED BY THE ENGINEER. THE ITEM SHALL CONSIST OF REPAIRING EXISTING LOCATIONS EXHIBITING SURFACE DETERIORATION AND PLACING 3"± OF ITEM 448 ASPHALT CONCRETE, TYPE 2. THE ASPHALT CONCRETE SHALL BE COMPACTED WITH A TYPE 1 PNEUMATIC TIRE ROLLER AND A STEEL WHEEL ROLLER AS PER 401.13. IT IS NOT THE INTENT TO REPAIR EVERY DETERIORATED AREA WITHIN THE PROJECT. THE ENGINEER SHALL DETERMINE WHICH AREAS ARE TO BE REPAIRED. UNLESS OTHERWISE DIRECTED BY THE ENGINEER, THIS ITEM SHALL BE PERFORMED AFTER THE COMPLETION OF MAINLINE PAVEMENT PLANING. ALSO, THIS ITEM SHALL COMMENCE WITHIN 7 DAYS OF THE COMPLETION OF MAINLINE PAVEMENT PLANING. PAYMENT SHALL BE BASED ON THE ACTUAL NUMBER OF SQUARE YARDS OF PAVEMENT REPAIR. THE FOLLOWING ESTIMATED QUANTITY HAS BEEN CARRIED TO THE GENERAL SUMMARY:

251, PARTIAL DEPTH PAVEMENT REPAIR, 700 SQ. YD.

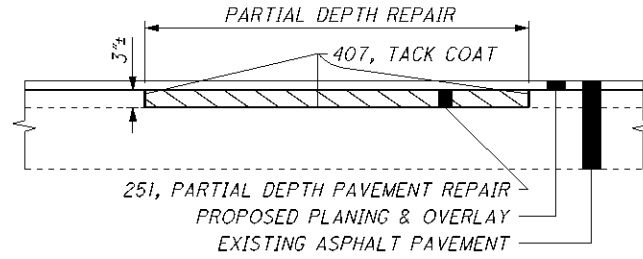

TYPE A ANCHOR ASSEMBLY REPLACEMENT

THERE ARE 6 LOCATIONS BETWEEN SLM 0.00 AND SLM 4.32 WHERE TYPE A ANCHOR ASSEMBLIES CURRENTLY EXIST ADJACENT TO SR 173. THE FOLLOWING ITEMS WILL BE USED TO REMOVE THE EXISTING ANCHOR ASSEMBLY, TYPE A AND 3 PANELS OF EXISTING GUARDRAIL AND INSTALL A NEW ANCHOR ASSEMBLY, TYPE E-98 AND 1 PANEL GUARDRAIL, TYPE 5 FOR EACH LOCATION: GUARDRAIL REMOVED, 62.5 FT BORROW, 2.5 CU YD GUARDRAIL, TYPE 5, 12.5 FT ANCHOR ASSEMBLY, TYPE E-98, 1 EACH BARRIER REFLECTOR, TYPE A, 2 EACH SEEDING AND MULCHING, 33 SQ YD

ALL MATERIALS, LABOR, EQUIPMENT, TOOLS, AND INCIDENTALS NECESSARY TO COMPLETE THIS WORK SHALL BE INCLUDED IN THE UNIT PRICE FOR THE PERTINENT BID ITEM. THE FOLLOWING QUANTITIES HAVE BEEN CARRIED TO THE GENERAL SUMMARY:

202, GUARDRAIL REMOVED	375 FEET
203, BORROW	15 CU YD
606, GUARDRAIL, TYPE 5	75 FEET
606, ANCHOR ASSEMBLY, TYPE E-98	6 EACH
626, BARRIER REFLECTOR, TYPE A	12 EACH
659, SEEDING AND MULCHING	198 SQ YD
659, COMMERCIAL FERTILIZER	0.03 TON
659, LIME	0.04 ACRES
659, WATER	2 M. GAL.

CROSS-SLOPE AND DISTRESSED PAVEMENT CORRECTION

THE FOLLOWING ESTIMATED QUANTITY HAS BEEN INCLUDED IN THE GENERAL SUMMARY FOR USE AS DIRECTED BY THE ENGINEER TO CORRECT CROSS-SLOPE AND STRENGTHEN DISTRESSED PAVEMENT AREAS BETWEEN SLM 3.10 AND SLM 3.15 ON SR 173.

QUANTITY THAT WILL BE CARRIED TO THE GENERAL SUMMARY:
448, ASPHALT CONCRETE INTERMEDIATE COURSE, TYPE 1, PG64-22 80 CU YD

ITEM SPECIAL - MAILBOX SUPPORT

THIS WORK SHALL CONSIST OF FURNISHING AND ERECTING MAILBOX SUPPORTS AND ANY ASSOCIATED MOUNTING HARDWARE IN ACCORDANCE WITH PLAN DETAILS, AND ATTACHING AN OWNER-SUPPLIED MAILBOX AT LOCATIONS SPECIFIED IN THE PLAN, OR OTHERWISE ESTABLISHED BY THE ENGINEER.

WOOD POSTS SHALL BE NOMINAL 4" BY 4" SQUARE OR 4 1/2" DIAMETER ROUND, AND CONFORM TO 710.14.

STEEL POSTS SHALL BE NOMINAL PIPE SIZE 2" I.D. O.D., AND CONFORM TO AASHTO M 181.

HARDWARE (PLATES, SCREWS, BOLTS, ETC.) SHALL BE COMMERCIAL-GRADE GALVANIZED STEEL.

POSTS SHALL BE SET PER THE FIRST PARAGRAPH OF 606.03, AND SHALL IN NO INSTANCE BE ENCASED IN CONCRETE.

SUPPORT HARDWARE SHALL ACCOMMODATE EITHER A SINGLE OR A DOUBLE MAILBOX INSTALLATION, AND NO MORE THAN TWO BOXES MAY BE MOUNTED ON A SINGLE POST.

THE MAILBOX SHALL BE SECURELY AND NEATLY ATTACHED BY THE CONTRACTOR TO THE NEW SUPPORT. THE CONTRACTOR SHALL FURNISH ALL NECESSARY ATTACHMENT HARDWARE (NUTS, BOLTS, PLATES, SPACERS, AND WASHERS) AS NECESSARY TO ACCOMMODATE THE COMPLETE INSTALLATION.

IN THE ABSENCE OF A NEW BOX SUPPLIED BY THE OWNER, THE CONTRACTOR SHALL SALVAGE THE EXISTING BOX AND PLACE IT ON THE NEW SUPPORT. DUE CARE SHALL BE EXERCISED IN SUCH AN OPERATION, AND THE CONTRACTOR SHALL BE RESPONSIBLE FOR REPAIRING OR REPLACING ANY BOX DAMAGED BY IMPROPER HANDLING ON HIS PART, AS JUDGED AND DIRECTED BY THE ENGINEER.

THE CONTRACTOR SHALL BE RESPONSIBLE FOR COORDINATING WITH THE LOCAL POST MASTER REGARDING THE TIMING OF THE MOVEMENT OF ANY MAILBOX TO A NEW LOCATION.

PAYMENT UNDER THIS ITEM SHALL BE LIMITED TO FINAL PERMANENT INSTALLATIONS. TEMPORARY INSTALLATIONS SHALL BE IN ACCORDANCE WITH 107.10. HOWEVER, THE SAME MATERIAL AND SIZE LIMITATIONS AS FOR PERMANENT INSTALLATIONS SHALL APPLY.

MAILBOX SUPPORTS, COMPLETE IN PLACE, WILL BE PAID FOR AT THE CONTRACT UNIT PRICE PER EACH, FOR ITEM SPECIAL MAILBOX SUPPORT SYSTEM, SINGLE

SPECIAL, MAILBOX SUPPORT SYSTEM, SINGLE 5 EACH

ITEM 422 - SINGLE CHIP SEAL WITH POLYMER BINDER, AS PER PLAN (NO. 8 FOR SINGLE CHIP SEAL OR NO. 8 ON TOP OF NO. 8 FOR DOUBLE CHIP SEAL)

THE REQUIREMENTS OF ALL LANGUAGE IN 422 APPLIES EXCEPT AS MODIFIED AS FOLLOWS:

IN SECTION 422.02 MATERIALS:

REMOVE THE FIRST SENTENCE AND ADD 'FOR PROJECTS WITH AN ADT OF LESS THAN 500 USE RS-2 EMULSIFIED BINDER CONFORMING TO 702.04. FOR PROJECTS WITH AN ADT OF 500 OR GREATER USE CRS-2P POLYMER EMULSIFIED BINDER CONFORMING TO 702.16 TYPE A. FOR PROJECTS WITH MULTIPLE PAVEMENTS WITH ADTS ABOVE AND BELOW 500 USE CRS-2P POLYMER EMULSIFIED BINDER CONFORMING TO 702.16 TYPE A.'

REMOVE AND REPLACE PARAGRAPH TWO WITH 'FOR COVER AGGREGATE MATERIAL, USE WASHED LIMESTONE OR DOLOMITE MEETING 703.05 AND THE REQUIRED GRADATION EXCEPT APPLY A WASHED GRADATION VALUE OF 1.5 MAX FOR THE NO. 200 SIEVE. SUBMIT A LETTER TO THE ENGINEER AND (DET) CONTAINING THE JMF GRADATION OF THE COVER AGGREGATE SHOWING ALL SIEVE SIZES AND ALL INDIVIDUAL SAMPLE RESULTS. DETERMINE THE JMF GRADATION BY TAKING FIVE SAMPLES TAKEN FROM DIFFERENT LOCATIONS OF STOCKPILED AGGREGATE THAT WILL NOT BE MOVED EXCEPT DIRECTLY TO THE AGGREGATE SPREADER IMMEDIATELY BEFORE STARTING THE JOB. IF THE AVERAGE OF THE FIVE SAMPLES DEVIATE MORE THAN 3.0 PERCENT PASSING ON THE NO. 8 (2.36 mm) SIEVE, REWORK THE STOCKPILE, TAKE

FIVE NEW SAMPLES, AND DETERMINE THE JMF GRADATION. IF ANY OF THE FIVE SAMPLES ARE MORE THAN 2.0 PERCENT (WASHED VALUE) FOR THE NO. 200 SIEVE DO NOT USE THE PILE. RETEST A NEW PILE, RE-WASHED PILE OR RE-WORKED PILE. INCLUDE BOTH A DRY GRADATION VALUE AND A WASHED GRADATION VALUE FOR PASSING THE NO. 200 (75 um) SIEVE IN THE JMF.' APPLY 703.01 F. RESTRICTIONS AS DESIGNATED IN THE AGGREGATE SOURCE GROUP LIST.

IN SECTION 422.03 EQUIPMENT

REPLACE PARAGRAPH TWO WITH 'USE EQUIPMENT FOR BINDER DISTRIBUTION CONFORMING TO 407.03. IN ADDITION ENSURE THAT IT HAS A COMPUTERIZED RATE CONTROL THAT AUTOMATICALLY ADJUSTS THE BINDER PUMP TO THE UNIT GROUND SPEED AND HAS A GAUGE OR METER IN PLAIN VIEW FOR READING GALLONS. USE APPROPRIATE SPRAY NOZZLES FOR THE MATERIAL AND RATE SPECIFIED.'

IN SECTION 422.05 TEST STRIP:

ADD TO PARAGRAPH ONE AFTER SENTENCE THREE 'CALIBRATE THE AGGREGATE SPREADER AND VERIFY THE APPLICATION RATE WITH A ONE SQUARE YARD PIECE OF CARDBOARD OR OTHER MATERIAL TO COLLECT AND WEIGHT THE AGGREGATE. DO NOT OVER APPLY COVER AGGREGATE RELYING ON VACUUM AND BROOM SWEEPING TO PICK UP ALL EXCESS. NUISANCE (TO THE PUBLIC) AMOUNTS OF AGGREGATE WILL RESULT IN WORK STOPPAGE. IF WORK IS STOPPED BY THE ENGINEER RECALIBRATE THE AGGREGATE SPREADER DETERMINING A NEW APPLICATION RATE AND APPLY COVER AGGREGATE AT THE NEW RATE.'

IN SECTION 422.08 COVER AGGREGATE APPLICATION:

ADD AS THE FIRST SENTENCE 'VERIFY THE APPLICATION RATE WITH A ONE SQUARE YARD PIECE OF CARDBOARD OR OTHER MATERIAL TO COLLECT AND WEIGHT THE AGGREGATE BEFORE PLACING BINDER. ADJUST IF NECESSARY AND RE-VERIFY. RECORD FINAL RESULTS AND INFORM THE ENGINEER.' ADD TO PARAGRAPH ONE AFTER SENTENCE ONE 'DO NOT OVER APPLY COVER AGGREGATE WITH INTENT ON RELYING ON VACUUM AND BROOM SWEEPING TO PICK UP ALL EXCESS. NUISANCE (TO THE PUBLIC) AMOUNTS OF AGGREGATE WILL RESULT IN WORK STOPPAGE. IF WORK IS STOPPED BY THE ENGINEER RE-CALIBRATE THE AGGREGATE SPREADER AND RE-VERIFY THE AGGREGATE SPREAD RATE DETERMINING A NEW APPLICATION RATE AND APPLY COVER AGGREGATE AT THE NEW RATE.'

IN SECTION 422.09 CONSTRUCTION OPERATION:

ESTABLISH STATIONS AT 1000-FOOT (300 m) INTERVALS ON THE ENTIRE PROJECT BEFORE PLACING MATERIALS. CLEARLY IDENTIFY AND MAINTAIN THE STATIONS UNTIL PROJECT COMPLETION.

KEEP THE BINDER DISTRIBUTOR, AGGREGATE SPREADER, AND ROLLERS AS CLOSE TO EACH OTHER AS POSSIBLE. DO NOT ALLOW THE POLYMER BINDER DISTRIBUTOR TO BE MORE THAN 150 FEET (45 m) AHEAD OF THE AGGREGATE SPREADER. PERFORM ROLLING IMMEDIATELY AFTER PLACING THE AGGREGATE, BUT BEFORE THE POLYMER BINDER SETS UP. DO NOT LEAVE AGGREGATE UNROLLED FOR MORE THAN 5 MINUTES. PERFORM A MINIMUM OF TWO COMPLETE ROLLER PASSES OVER THE AGGREGATE. A SINGLE COMPLETE PASS IS FORWARD AND BACKWARD OVER THE SAME PATH. FOR EACH NEW PASS, OVERLAP THE PREVIOUS PASS BY ABOUT ONE-HALF THE WIDTH OF THE ROLLER. USE A MINIMUM OF THREE ROLLERS, AND ROLL IN A LONGITUDINAL DIRECTION AT A SPEED NOT GREATER THAN 5 MILES PER HOUR (8 km/h). DO NOT OPERATE ROLLERS AT SPEEDS THAT CAUSE PICK-UP OR DISLODGING OF AGGREGATE PARTICLES. AFTER THE BINDER SETS ENOUGH TO RETAIN AGGREGATE BUT WITHIN 4 HOURS, SWEEP THE PAVEMENT USING A POWER BROOM OR PICKUP SWEEPER AS NEEDED TO REMOVE ALL LOOSE AGGREGATE. IF THE CONTRACTOR CANNOT SWEEP THE PAVEMENT WITHIN THE 4-HOUR PERIOD DUE TO PROBLEMS ASSOCIATED WITH THE BINDER, BREAKING, HUMIDITY, OR OTHER UNKNOWN, THE ENGINEER MAY SUSPEND THE OPERATION UNTIL THE PROBLEM IS RESOLVED OR MORE SUITABLE CONDITIONS ARE OBTAINED TO

MAINTAIN THE 4-HOUR TIME FRAME FOR SWEEPING. PERFORM ADDITIONAL SWEEPINGS AS NEEDED TO PREVENT LOOSE STONE PROBLEMS. EXTEND SWEEPING 1 FOOT (0.3 m) BEYOND THE EDGE OF PAVEMENT TO HELP PREVENT MIGRATION OF LOOSE AGGREGATE BACK ONTO THE PAVEMENT. DO NOT RE-USE AGGREGATE IN A CHIP SEAL THAT IS SWEEPED FROM THE PAVEMENT OR THAT IS ALREADY LOOSE OFF THE PAVEMENT EDGE.

THE CONTRACTOR IS RESPONSIBLE FOR CLAIMS OF DAMAGE TO VEHICLES UNTIL THE PAVEMENT AND SHOULDERS RECEIVE A FINAL SWEEPING IMMEDIATELY BEFORE APPLICATION OF PERMANENT PAVEMENT MARKINGS OR A FOG SEAL, IF A FOG SEAL IS REQUIRED

FOR DOUBLE CHIP SEAL, ALLOW THE FIRST COURSE TO SET AT LEAST 4 HOURS BEFORE PLACING THE SECOND COURSE OF CHIP SEAL. BEFORE PLACING THE SECOND COURSE, ENSURE THAT THE FIRST COURSE IS CURED, SWEEPED, AND CAPABLE OF WITHSTANDING CONSTRUCTION TRAFFIC WITHOUT DAMAGE. CORRECT DAMAGE TO THE UNDERLYING CHIP SEAL BEFORE PLACING THE FINAL CHIP SEAL.

PLACE THE LONGITUDINAL CONSTRUCTION JOINT ON A LANE LINE OR AS DIRECTED BY THE ENGINEER. FOR DOUBLE CHIP SEAL, PLACE THE LONGITUDINAL CONSTRUCTION JOINT FOR THE FIRST COURSE 6 INCHES (150 mm) OFF THE CENTERLINE AND PLACE THE SECOND COURSE SO THE LONGITUDINAL JOINT IS AT THE CENTERLINE.

BEFORE OPENING TO TRAFFIC, POST THE ROADWAY WITH "LOOSE STONE" SIGNS AND A "35 MPH" SPEED PLAQUE MOUNTED BELOW THE SIGN. ENSURE THAT SIGNS CONFORM TO ITEM 614. PLACE THESE SIGNS AT A MAXIMUM OF 0.5-MILE (0.8 km) INTERVALS. REMOVE THE SIGNS AS DIRECTED BY THE ENGINEER.

ON TWO-LANE ROADS OR PAVEMENTS WHERE TRAFFIC IS MAINTAINED ON A CHIP SEAL CONSTRUCTED THAT WORKDAY, A TRAFFIC CONTROL PILOT VEHICLE OPERATED AT NO MORE THAN 25 MILES PER HOUR (40 km/h) IS REQUIRED IN THE IMMEDIATE WORK AREA.

PROTECT ALL UTILITY CASTINGS, MONUMENT BOXES, AND OTHER SIMILAR ITEMS USING TARPAPER OR OTHER APPROVED MATERIAL. PROTECT RPMS LEFT IN PLACE FOR A SINGLE CHIP SEAL. REMOVE RPMS AND REPLACE FOR A DOUBLE CHIP SEAL. REMOVE PROTECTION BEFORE SWEEPING AND OPENING TO TRAFFIC.

IN SECTION 422.10 QUALITY CONTROL:

A. GENERAL. REMOVE 'THE DET CAN OBTAIN SAMPLES OF MATERIALS AT ANY TIME.' AND REPLACE WITH 'THE DEPARTMENT CAN OBTAIN SAMPLES OF MATERIALS AT ANY TIME. AGGREGATE SAMPLES CAN BE TAKEN FROM SOURCES, ON HAND STOCKPILES OR THE AGGREGATE SPREADER BOX. WORK CAN BE STOPPED AND MATERIALS CAN BE REJECTED ON THE BASIS OF POOR DEPARTMENT TEST RESULTS.'

C. COARSE AGGREGATE. ADD 'SAMPLE AND TEST ONE SAMPLE TAKEN FROM THE AGGREGATE SPREADER BOX AT PRODUCTION START AND SAMPLE AND TEST ONE SAMPLE TAKEN FROM THE AGGREGATE SPREADER BOX RANDOMLY DURING THE DAY, MINIMUM. INCLUDE ADDITIONAL TESTING WHEN DIRECTED TO SAMPLE AND TEST BY THE ENGINEER.' REMOVE 'IF PROBLEMS PERSIST WITH DRY GRADATIONS RESULTS, PERFORM WASHED GRADATIONS.' ADD 'USE WASHED GRADATIONS FOR DETERMINING THE NO. 200 SIEVE. THE CONTRACTOR MAY USE ADDITIONAL TESTS. THESE MAY INCLUDE DRY GRADATIONS FOR CONTROL PURPOSES BUT ACCEPTANCE OF ON HAND AGGREGATE IS BASED ON WASHED GRADATIONS ONLY.' ADD 'REJECT AND DO NOT USE AGGREGATE CREATING NUISANCE (TO THE PUBLIC) DUSTING ON THE PROJECT.' IN ADDITION APPLY A REVISED WASHED GRADATION UPPER LIMIT OF 2.0% FOR THE NO. 200 SIEVE.

D. DOCUMENTATION. NO. 7: CHANGE FREQUENCY TO 'SAMPLE AND TEST ONE SAMPLE TAKEN FROM THE AGGREGATE SPREADER BOX AT PRODUCTION START AND SAMPLE AND TEST ONE SAMPLE TAKEN RANDOMLY FROM THE AGGREGATE SPREADER BOX DURING THE DAY, MINIMUM. INCLUDE ADDITIONAL TEST RESULTS WHEN DIRECTED TO SAMPLE AND TEST BY THE ENGINEER.'

GENERAL NOTES

STA - 153/ 173-7.47 / 0.00

INTERSECTIONS

SR 153 SLM 7.47 TO SLM 9.87 AND SR 173 SLM 0.00 TO SLM 1.98, INTERSECTIONS WILL BE RESURFACED 25 FT. BEYOND THE EDGE LINE UNLESS OTHERWISE DIRECTED BY THE ENGINEER OR INDICATED IN THE PLAN.

SR 173 SLM 1.98 TO SLM 4.32, INTERSECTIONS WILL BE RESURFACED 2 FT. BEYOND THE EDGE LINE UNLESS OTHERWISE DIRECTED BY THE ENGINEER OR INDICATED IN THE PLAN. INTERSECTIONS SHALL BE PAVED AFTER COMPLETION OF THE SURFACE COURSE OR WITH THE MAINLINE PAVEMENT IF THIS CAN BE ACCOMPLISHED WITHOUT CHANGING THE VELOCITY AND DIRECTION OF THE PAVER. USE THE SAME ASPHALT CONCRETE AS THE MAINLINE PAVEMENT. PROVIDE A SMOOTH TRANSITION TO THE EXISTING PAVEMENT. ANY GRADING OR PRIME NECESSARY TO ACCOMPLISH THIS WORK SHALL BE INCLUDED IN THE COST OF THE PERTINENT BID ITEM.

ITEM 448 ASPHALT CONCRETE SURFACE COURSE, TYPE 1, PG64-22 (DRIVEWAYS)

THIS ITEM OF WORK SHALL CONSIST OF PAVING ALL EXISTING DRIVEWAYS ON SR 153 SLM 7.47 TO SLM 9.87 AND SR 173 SLM 0.00 TO SLM 1.98 THAT DO NOT HAVE A CURB CUT OR ARE NOT PAVED AS AN INTERSECTION AS SHOWN ON THE ASPHALT CONCRETE PLAN SHEET. DRIVEWAYS ARE TO BE PAVED A DISTANCE OF 10 FT. FROM THE EDGE OF PAVED SHOULDER UNLESS OTHERWISE DIRECTED BY THE ENGINEER. DRIVEWAYS SHALL BE PAVED AFTER COMPLETION OF THE SURFACE COURSE. ASPHALT CONCRETE AVERAGE THICKNESSES SHALL BE 2 IN. FOR AGGREGATE DRIVEWAYS (UNIMPROVED) AND 1 IN. FOR IMPROVED DRIVEWAYS. AGGREGATE DRIVEWAYS SHALL BE GRADED PRIOR TO PAVING SUCH THAT SURFACE DRAINAGE DOES NOT ENCROACH UPON THE PAVED SHOULDER. THE MAXIMUM PAVED WIDTH SHALL NOT EXCEED THAT ALLOWED FOR THROAT AND RADIUS FOR UNCURBED DRIVEWAYS AS PER STANDARD DRIVE DESIGN MANUAL. ALL GRADING, TOOLS, EQUIPMENT, MATERIAL AND INCIDENTALS REQUIRED TO LAYOUT AND CONSTRUCT THE DRIVEWAYS SHALL BE INCLUDED IN THE UNIT PRICE BID FOR ITEM 448 ASPHALT CONCRETE SURFACE COURSE, TYPE 1, PG64-22 (DRIVEWAYS).

PAVED MAILBOX APPROACHES

ALL EXISTING MAIL BOX APPROACHES ON SR 153 SLM 7.47 TO SLM 9.87 AND SR 173 SLM 0.00 TO SLM 1.98 WILL BE PAVED WITH ASPHALT CONCRETE AS PER TYPICAL SHOWN OR AS NEAR AS PRACTICAL. AGGREGATE APPROACHES SHALL HAVE A 2 IN. MIN. THICKNESS; IMPROVED APPROACHES SHALL HAVE A 2 IN. MIN. THICKNESS. THE CONTRACTOR SHALL HAVE THE OPTION OF PAVING THE MAILBOX APPROACHES WITH EITHER THE PAVING OF THE DRIVEWAYS OR THE PAVING OF THE MAINLINE AND SHOULDERS. PAYMENT SHALL BE AS FOLLOWS:

1. SHOULD THE CONTRACTOR ELECT TO PAVE THE MAILBOX APPROACHES WITH THE DRIVEWAYS THEN ALL GRADING, TACK, TOOLS, EQUIPMENT, MATERIAL AND INCIDENTALS REQUIRED FOR THE CONTRACTOR TO LAYOUT AND CONSTRUCT THE MAILBOX APPROACHES SHALL BE INCLUDED IN THE UNIT PRICE BID FOR ITEM 448, ASPHALT CONCRETE SURFACE COURSE, TYPE 1, PG64-22 (DRIVEWAYS).

2. SHOULD THE CONTRACTOR ELECT TO PAVE THE MAILBOX APPROACHES WITH THE MAINLINE AND SHOULDERS, THEN ALL GRADING, TACK, TOOLS, EQUIPMENT, MATERIAL AND INCIDENTALS REQUIRED TO LAYOUT AND CONSTRUCT THE MAILBOX APPROACHES SHALL BE INCLUDED IN THE UNIT BID FOR ITEM 446, ASPHALT CONCRETE SURFACE COURSE, TYPE 1, PG70-22M.

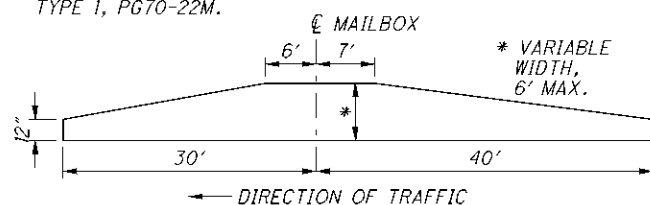

ITEM 606 - ANCHOR ASSEMBLY, TYPE E-98

THIS ITEM SHALL CONSIST OF FURNISHING AND INSTALLING EITHER OF THE FOLLOWING GUARDRAIL END TERMINALS, OR AN APPROVED EQUAL AS LISTED ON ROADWAY ENGINEERING'S WEB PAGE AT WWW.DOT.STATE.OH.US/DRRC/ UNDER ROADSIDE SAFETY DEVICES FOR APPROVED GUARDRAIL END TREATMENTS:

1) THE ET-2000 (1997) MANUFACTURED BY TRINITY INDUSTRY, 1170 N. STATE STREET, GIRARD, OHIO 44420 (TELEPHONE: 330-545-4373).

THE LENGTH OF THE ET-2000 (1997) SYSTEM IS CONSIDERED TO BE 50'-0", INCLUSIVE OF TWO 25'-0" LONG RAIL ELEMENTS. INSTALLATION SHALL BE AT THE LOCATIONS SPECIFIED IN THE PLANS, IN ACCORDANCE WITH THE MANUFACTURER'S SPECIFICATIONS AS DETAILED ON THE FOLLOWING PRE-APPROVED SHOP DRAWINGS:

DWG. NO.	DRAWING NAME	DATE	DATE
SSS265M	ET-2000 (1997) PLAN, ELEVATION AND SECTIONS	6/20/97	3/6/98
SSI42	ET2000 PLUS 50'-0" PLAN, ELEVATION AND SECTION 25'-0" RAIL, SLEEVE W/PL POSTS 1-4	4/12/00	7/31/00
SSI41	ET2000 PLUS PLAN, ELEVATION AND SECTION 25'-0" RAIL, HBA POSTS 1-4	2/29/00	7/31/00
SSI58	ET2000 PLUS 50'-0" WITH 12'-6" PANELS AND HBA POSTS 1-4 PLAN, ELEVATION AND SECTION	5/22/00	7/31/00

2) THE SKT-350 MANUFACTURED BY ROAD SYSTEMS, INC., 2516 MALLORY LANE, STOW, OHIO, 44224, (TELEPHONE: 330-346-0721).

THE LENGTH OF THE SKT-350 SYSTEM IS CONSIDERED TO BE 50'-0", INCLUSIVE OF FOUR 12'-6" LONG RAIL ELEMENTS. INSTALLATION SHALL BE AT THE LOCATIONS SPECIFIED IN THE PLANS, IN ACCORDANCE WITH THE MANUFACTURER'S SPECIFICATIONS AS DETAILED ON THE FOLLOWING PRE-APPROVED SHOP DRAWINGS:

DWG. NO.	DRAWING NAME	DATE	DATE
SKT-4M	SEQUENTIAL KINKING TERMINAL (SKT-350) ASSEMBLY WITH 4 FOUNDATION TUBES	12/11/97	3/6/98

THE FACE OF THE TYPE E-98 IMPACT HEAD SHALL BE COVERED WITH A SHEET OF TYPE G REFLECTIVE SHEETING, PER CMS 730.19, APPROXIMATELY 18" X 18", OR 12" X 18" IF APPLIED TO A RECTANGULAR ET-2000 PLUS EXTRUDER HEAD.

REFER TO THE MANUFACTURER'S INSTRUCTION REGARDING THE INSTALLATION OF, AND THE GRADING AROUND, THE FOUNDATION TUBES AND GROUND STRUT. THE TOP OF ANY FOUNDATION TUBE SHOULD BE LESS THAN 4-INCHES ABOVE THE GROUND. THE PLACEMENT OF THE FOUNDATION TUBES SHOULD BE AN APPROPRIATE DEPTH BELOW THE LEVEL LINE IN ORDER TO MAINTAIN THE FINISHED GUARDRAIL HEIGHT OF 27-3/4-INCHES FROM THE EDGE OF THE SHOULDER.

ON-SITE GRADING IS REQUIRED IF THE TOP OF THE FOUNDATION TUBES OR TOP OF THE GROUND STRUT DOES PROJECT MORE THAN 4-INCHES ABOVE THE GROUND LINE.

PAYMENT FOR THE ABOVE WORK SHALL BE MADE AT THE UNIT PRICE BID FOR ITEM 606, ANCHOR ASSEMBLY, TYPE E-98, EACH, AND SHALL INCLUDE ALL LABOR, TOOLS, EQUIPMENT AND MATERIALS NECESSARY TO CONSTRUCT A COMPLETE AND FUNCTIONAL ANCHOR ASSEMBLY SYSTEM, INCLUDING ALL RELATED TRANSITIONS, REFLECTIVE SHEETING, HARDWARE, GRADING, EMBANKMENT AND EXCAVATION NOT SEPARATELY SPECIFIED, AS REQUIRED BY THE MANUFACTURER.

I:\Projects\STA\25581_153_0747\25581\roadway\sheets\25581GN001.dgn 08-FEB-2008 10:20AM rbaughma

CALCULATED
RCB
CHECKED
TJP

GENERAL NOTES

STA - 153 / 173 - 7.47 / 0.00

MAINTENANCE OF TRAFFIC

THIS ITEM SHALL CONSIST OF MAINTENANCE OF TRAFFIC ON EXISTING ROADWAYS AND RAMPS IN ACCORDANCE WITH THE OHIO MANUAL OF UNIFORM TRAFFIC CONTROL DEVICES FOR STREETS AND HIGHWAYS, CURRENT EDITION, LATEST REVISION, THE SPECIFICATIONS AND THE FOLLOWING:

1. A MINIMUM OF ONE TEN FOOT BIDIRECTIONAL LANE SHALL BE MAINTAINED ON THE EXISTING PAVEMENT OR COMPLETED PAVEMENT DURING CONSTRUCTION OF THE WORK EXCEPT WHERE THE DETOUR IS IN EFFECT.
2. THE CONTRACTOR SHALL INFORM THE DISTRICT OFFICE (330) 786-2211, EIGHTEEN (18) DAYS PRIOR TO THE BEGINNING OF WORK.
3. CONES SHALL NOT BE ACCEPTABLE TRAFFIC CONTROL DEVICES FOR LANE RESTRICTIONS OR LANE REDUCTIONS THAT ARE IN OPERATION ONE-HALF HOUR AFTER SUNSET OR ONE HALF-HOUR BEFORE SUNRISE. ALL NIGHTTIME LANE RESTRICTIONS SHALL REQUIRE DRUMS OR BARRICADES AT A MAXIMUM SPACING OF FIFTY (50) FEET. WEIGHTED CHANNELIZERS MAY BE USED IN ACCORDANCE WITH THE ADDITIONAL NOTE HEREIN.
4. LANE RESTRICTIONS OR LANE REDUCTIONS SHALL NOT BE PERMITTED AFTER NORMAL WORKING HOURS. NORMAL WORKING HOURS SHALL BE THOSE HOURS DURING WHICH THE CONTRACTOR HAS A FULL COMPLEMENT OF EMPLOYEES AND EQUIPMENT ACTIVELY REMOVING AND/OR PLACING PAVEMENT MATERIALS.
5. THE CONTRACTOR SHALL FURNISH, ERECT, MAINTAIN AND SUBSEQUENTLY REMOVE ALL FLAGS, BARRICADES, SIGNS, SIGN SUPPORTS AND FURNISH AND MAINTAIN ALL FLAGGERS, WATCHERS AND INCIDENTALS RELATED THERETO.
6. UNDER NO CIRCUMSTANCES SHALL THE CONTRACTOR BE PERMITTED TO HAVE SUCCESSIVE WORK ZONES UNLESS THE DISTANCE BETWEEN THE DRUMS, BARRICADES OR CONES EXCEEDS TWO (2) MILES.
7. RESIDENTIAL AREAS: NO WORK WILL BE PERFORMED FROM 10:00PM TO 6:00AM DAILY.
8. IN ADDITION TO THE REQUIREMENTS OF 614.11 WORK ZONE PAVEMENT MARKINGS, AT THE END OF EACH DAY OF WORK, THE CONTRACTOR SHALL REPLACE (WITH WORK ZONE MARKINGS) ALL CENTER AND STOP LINES THAT WERE REMOVED OR COVERED DURING THE PAVEMENT REMOVAL OR PLACEMENT OPERATIONS. QUANTITIES FOR SUCH PLACEMENT ARE CARRIED AS PART OF THE ITEMS LISTED UNDER 614 WORK ZONE PAVEMENT MARKINGS.
9. A QUANTITY OF 20 CU. YDS. OF 614 ASPHALT CONCRETE FOR MAINTAINING TRAFFIC SHALL BE PROVIDED FOR USE IN MAINTAINING PAVEMENT, SHOULDERS AND OTHER LOCATIONS AS DIRECTED BY THE ENGINEER.
10. PRIOR TO OPENING TO TRAFFIC EACH LANE SHALL BE IN A SAFE, PASSABLE CONDITION. ALL TRANSVERSE JOINTS SHALL EXTEND ACROSS THE FULLLANE AND SHOULDER WIDTH AND EACH LANE SHALL BE FREE FROM UNEVEN LONGITUDINAL JOINTS. THE CONTRACTOR SHALL PROVIDE ASPHALT WEDGES FOR TRANSVERSE JOINTS WHEREVER THERE ARE PAVEMENT ELEVATION DIFFERENCES.
11. A QUANTITY OF ITEM 614 WORK ZONE MARKING SIGN HAS BEEN INCLUDED IN THE PLAN. THIS QUANTITY SHALL INCLUDE, BUT NOT BE LIMITED TO, THE FOLLOWING SIGNS: W8-1 [BUMP], W6-3 [TWO-WAY TRAFFIC], W8-H13 [NO EDGE LINES], R4-1 [DO NOT PASS], R4-2 [PASS WITH CARE], W8-11 [UNEVEN LANES]. THESE QUANTITIES SHALL BE AS PER 614.04.

THE FOLLOWING QUANTITIES SHALL BE USED FOR THE MAINTENANCE OF TRAFFIC ON THIS PROJECT:

PHASE 1 - PLANED SURFACES
614, WORK ZONE CENTER LINE, CLASS II, 7.02 MILE
614, WORK ZONE STOP LINE, CLASS 1, 18 FT
614, WORK ZONE MARKING SIGN, 32 EACH

PHASE 2 - 422 CHIP SEAL SURFACE
614, WORK ZONE CENTER LINE, CLASS II, 1.72 MILE
614, WORK ZONE STOP LINE, CLASS 1, 18 FT

PHASE 3 - 446 INTERMEDIATE COURSES
614, WORK ZONE CENTER LINE, CLASS II, 4.12 MILE
614, WORK ZONE STOP LINE, CLASS 1, 18 FT

PHASE 4 - 446 SURFACE COURSES
614, WORK ZONE CENTER LINE, CLASS II, 7.28 MILE
614, WORK ZONE STOP LINE, CLASS 1, 18 FT

TO BE USED AS DIRECTED BY THE ENGINEER FOR US-62 RAMP AREAS:
614, WORK ZONE LANE LINE, CLASS II, 0.15 MILE
614, WORK ZONE CHANNELIZING LINE, CLASS 1, 652 FT
614, WORK ZONE STOP LINE, CLASS 1, 40 FT

CONTRACTOR'S EQUIPMENT - OPERATION AND STORAGE

A QUALIFIED FLAGGER SHALL BE EMPLOYED WHERE THE CONTRACTOR'S EQUIPMENT MUST MERGE WITH THE TRAFFIC STREAM. THE CONTRACTOR'S EQUIPMENT SHALL BE EQUIPPED WITH AT LEAST ONE AMBER FLASHING LIGHT. PAVERS, ROLLERS AND OTHER EQUIPMENT MAY BE PARKED IN AREAS ALONG THE HIGHWAY WHEN PAVING OPERATIONS ARE SCHEDULED TO CONTINUE WITHIN THE NEXT WORKDAY. OTHERWISE THE EQUIPMENT SHALL BE STORED AT A STORAGE AREA OUTSIDE THE R/W, THE LOCATION OF WHICH SHALL HAVE PRIOR APPROVAL OF THE ENGINEER. WHEN PARKING ALONG THE HIGHWAY THE EQUIPMENT SHALL BE PLACED AND DELINEATED AS PER 614.03. NO EQUIPMENT SHALL BE PARKED IN THE MEDIAN OF THE HIGHWAY. ADEQUATE BARRICADES AND LIGHTS SHALL BE PLACED ON THE PAVEMENT SIDE OF THE EQUIPMENT TO IDENTIFY THE LIMITS OF THE EQUIPMENT. ALL OTHER EQUIPMENT, INCLUDING PRIVATE VEHICLES, SHALL BE STORED AT THE APPROVED CONTRACTOR'S STORAGE AREA. NO EQUIPMENT SHALL BE PARKED ON PRIVATE PROPERTY UNLESS PRIOR APPROVAL OF THE OWNER AND THE PROJECT ENGINEER/SUPERVISOR HAS BEEN GRANTED.

WINTER TRAFFIC LIMITATIONS

ALL EXISTING LANES SHALL BE OPEN TO TRAFFIC BETWEEN NOVEMBER 15 AND APRIL 1. NOVEMBER 14 SHALL BE CONSIDERED TO CONSTITUTE AN INTERIM COMPLETION DATE AND LIQUIDATED DAMAGES AS SPECIFIED IN 108.07 SHALL BE ASSESSED FOR EACH CALENDAR DAY THAT THE ROADWAY REMAINS CLOSED TO TRAFFIC BEYOND THE SPECIFIED LIMIT. THE CONTRACTOR MAY CLOSE LANES PRIOR TO APRIL 1 WITH WRITTEN APPROVAL FROM THE DISTRICT CONSTRUCTION ENGINEER.

TRAFFIC CONTROL INSPECTOR

THE CONTRACTOR SHALL DESIGNATE AN INDIVIDUAL OTHER THAN THE SUPERINTENDENT AND SUBJECT TO THE APPROVAL OF THE ENGINEER, TO CONTINUOUSLY INSPECT ALL TRAFFIC CONTROL DEVICES WHENEVER CONSTRUCTION WORK IS BEING PERFORMED WITHIN THE WORK LIMITS OF THE PROJECT. THE DESIGNATED INDIVIDUAL SHALL ALSO INSPECT ALL TRAFFIC DEVICES AT THE BEGINNING AND AT THE END OF EACH WORK DAY. THE DESIGNATED INDIVIDUAL OR A QUALIFIED REPRESENTATIVE SHALL ALSO BE AVAILABLE ON AN AROUND THE CLOCK BASIS TO REPAIR AND/OR REPLACE DAMAGED OR MISSING TRAFFIC CONTROL DEVICES. THESE INDIVIDUALS SHALL BE EQUIPPED WITH CELLULAR PHONES AND THEIR NAMES AND PHONE NUMBERS SHALL BE GIVEN TO THE PROJECT ENGINEER AT THE PRE-CONSTRUCTION MEETING. THE DESIGNATED INDIVIDUAL MAY HAVE OTHER CONSTRUCTION RELATED DUTIES AS LONG AS IMMEDIATE ATTENTION IS GIVEN TO TRAFFIC CONTROL. PAYMENT FOR THE SERVICES OF THE TRAFFIC CONTROL INSPECTOR SHALL BE INCLUDED IN THE LUMP SUM PRICE BID FOR ITEM 614 MAINTAINING TRAFFIC.

ITEM 632 - DETECTOR LOOP, AS PER PLAN

THE CONTRACTOR SHALL CONTACT THE DISTRICT OFFICE (330-786-3146) THREE WORKING DAYS PRIOR TO ANY PLANING OR TRENCHING AT THE INTERSECTION OF SR-173 AND SR-44. ANY LOOP DETECTORS DISTURBED BY PAVEMENT PLANING OR TRENCHING SHALL BE ABANDONED IN PLACE.

ADVANCED NOTICE TO PAVE

THE CONTRACTOR SHALL SUBMIT FOR APPROVAL TO THE DISTRICT CONSTRUCTION ENGINEER A DETAILED SCHEDULE 15 DAYS PRIOR TO THE PLACEMENT OF THE OVERLAY COURSES, ON HOW THEY PROPOSE TO PROSECUTE THE PAVING OPERATIONS. THE DETAILS SHALL SHOW THE ORDER OF PERFORMANCE OF EACH STAGE (START TO FINISH) OF THE WORK INCLUDING THE MAINTENANCE OF TRAFFIC THAT WILL BE USED.

DESIGNATED LOCAL DETOUR ROUTE

IN ADDITION TO THE OFFICIAL, SIGNED DETOUR ROUTE, A LOCAL ROUTE HAS BEEN DETERMINED TO BE THE SECONDARY, UNSIGNED DETOUR ROUTE OR "DESIGNATED LOCAL DETOUR ROUTE." THIS ROUTE IS SHOWN ON SHEET NO. 7. DURING THE TIME THAT TRAFFIC IS DETOURED, THE CONTRACTOR SHALL MAINTAIN THIS ROUTE IN A CONDITION WHICH IS REASONABLY SMOOTH AND FREE FROM HOLES, RUTS, RIDGES, BUMPS, DUST AND STANDING WATER. ONCE THE DETOUR IS REMOVED AND TRAFFIC RETURNED TO ITS NORMAL PATTERN, THE DESIGNATED LOCAL DETOUR ROUTE SHALL BE RESTORED TO A CONDITION THAT IS EQUIVALENT TO THAT WHICH EXISTED PRIOR TO ITS USE FOR THIS PURPOSE. ALL SUCH WORK SHALL BE PERFORMED WHEN AND AS DETERMINED BY THE ENGINEER.

DETOUR NOTIFICATION [ODOT]

THE CONTRACTOR SHALL ADVISE THE ODOT DISTRICT OFFICE (330-786-3148) EIGHTEEN (18) DAYS IN ADVANCE OF WHEN THE DETOUR ROUTE SHOULD BE IN EFFECT. ALL WORK ZONE DEVICES REQUIRED SHALL BE FURNISHED, ERECTED, MAINTAINED, AND SUBSEQUENTLY REMOVED BY THE CONTRACTOR. PAYMENT FOR ALL WORK ASSOCIATED WITH THE DETOUR SHALL BE INCLUDED UNDER THE LUMP SUM BID FOR ITEM 614, DETOUR SIGNING.

DETOUR DURATION

THE MAXIMUM LENGTH OF TIME FOR THE DETOUR ROUTE TO BE IN EFFECT SHALL BE 7 CONSECUTIVE DAYS. CONSTRUCTION WORK MAY BE PERFORMED BEFORE AND AFTER THE DETOUR LIMITATION DATES, BUT THERE SHALL BE NO RESTRICTIONS (LANE WIDTH REDUCTIONS, TEMPORARY ROADWAYS, OR ONE WAY TRAFFIC) TO THROUGH OR LOCAL TRAFFIC. IT SHALL BE THE RESPONSIBILITY OF THE CONTRACTOR TO SCHEDULE AND PERFORM THE CONSTRUCTION WORK WITHIN THE DETOUR LIMITATION TIME. THE FAILURE OF THE CONTRACTOR TO MEET THE DETOUR LIMITATION DATES WILL CAUSE SEPARATE LIQUIDATED DAMAGES AS PER 108.07 OF THE CMS OF OVERRUN OF DETOUR LIMITATION TIME TO BE ASSESSED. THE CONTRACTOR WILL COMPLY WITH ALL PROVISIONS OF 108.07 OF THE DEPARTMENT OF TRANSPORTATION CONSTRUCTION AND MATERIAL SPECIFICATIONS.

ITEM 614, MAINTAINING TRAFFIC (NOTICE OF CLOSURE SIGN)

NOTICE OF CLOSURE SIGNS, AS DETAILED IN THESE PLANS, SHALL BE ERECTED BY THE CONTRACTOR AT LEAST ONE WEEK IN ADVANCE OF THE SCHEDULED ROAD OR RAMP CLOSURE. THE SIGNS SHALL BE ERECTED ON THE RIGHT-HAND SIDE OF THE ROAD/RAMP FACING TRAFFIC. THEY SHALL BE PLACED SO AS NOT TO INTERFERE WITH THE VISIBILITY OF ANY OTHER TRAFFIC CONTROL SIGNS. ON ROADWAYS, THEY SHOULD BE ERECTED AT THE POINT OF CLOSURE. THE SIGNS MAY BE ERECTED ANYWHERE ON RAMPS AS LONG AS THEY ARE VISIBLE TO THE MOTORISTS USING THE RAMP. ON ENTRANCE RAMPS, THE SIGN SHALL BE ERECTED WELL IN ADVANCE OF THE MERGE AREA TO AVOID DISTRACTING MOTORISTS.

SR-173 WILL BE
CLOSED (DATE)
FOR 7 DAYS
INFO: 330-786-2211

W20-H13-60

I:\Projects\STA\25581\153_0747\25581\roadway\sheets\25581M001.dgn 08-FEB-2008 10:20AM rbaughma

CALCULATED
MJH
CHECKED

MAINTENANCE OF TRAFFIC GENERAL NOTES

STA-153/173-7.47/0.00

5
23

I:\Projects\STA\25581_153_0747\roadway\sheets\25581MN001.dgn 08-FEB-2008 10:20AM rbaughma

WEIGHTED CHANNELIZERS

THE WEIGHTED CHANNELIZER SHALL BE PREDOMINATELY ORANGE IN COLOR AND SHALL BE MADE OF A LIGHTWEIGHT, FLEXIBLE, AND DEFORMABLE MATERIAL. THEY SHALL BE AT LEAST 42 INCHES IN HEIGHT WITH A WEIGHTED BASE. THEY MAY HAVE A "HANDLE" OR LIFTING DEVICE WHICH EXTENDS ABOVE THE 42 INCH MINIMUM HEIGHT.

THE MARKINGS ON THE WEIGHTED CHANNELIZER SHALL BE HORIZONTAL, CIRCUMFERENTIAL, ALTERNATING ORANGE AND WHITE RETROREFLECTIVE STRIPES 6 INCHES WIDE. EACH WEIGHTED CHANNELIZER SHALL HAVE A MINIMUM OF TWO ORANGE AND TWO WHITE STRIPES. ANY NON-RETROREFLECTIVE SPACES BETWEEN THE HORIZONTAL ORANGE AND WHITE STRIPES SHALL NOT EXCEED 2 INCHES WIDE. THE WEIGHTED CHANNELIZER SHALL HAVE A 4-INCH MINIMUM WIDTH, REGARDLESS OF ORIENTATION.

ON FREEWAYS AND MULTILANE HIGHWAYS:
USE OF WEIGHTED CHANNELIZERS ON FREEWAYS AND MULTILANE HIGHWAYS SHALL BE LIMITED TO SHORT-TERM OPERATION, GENERALLY TWELVE HOURS OR LESS, FOR EITHER DAY OR NIGHT. UPON COMPLETION OF WORK WITHIN THE ABOVE NOTED TIME PERIOD, THE WEIGHTED CHANNELIZERS SHALL BE REMOVED. THE WEIGHTED CHANNELIZERS MAY AGAIN BE PLACED ON THE HIGHWAY WHEN THE WORK IS TO RESUME ON THE FOLLOWING DAY OR NIGHT. ANY LANE CLOSURE USING CHANNELIZATION DEVICES, EXPECTED TO REMAIN FOR MORE THAN TWELVE HOURS, SHALL REQUIRE THE USE OF DRUMS OR BARRIERS.

WHEN USED AT NIGHT, WEIGHTED CHANNELIZERS SHALL ONLY BE PLACED IN THE "TANGENT AREA". THE "TANGENT AREA" IS DEFINED AS THE AREA AFTER THE TRANSITION TAPER WHERE THE WORK TAKES PLACE. DRUMS SHALL BE USED IN THE TRANSITION TAPERS FOR NIGHT OPERATIONS.

ON OTHER HIGHWAYS:
THERE ARE NO DURATIONS OF WORK RESTRICTIONS FOR USE OF WEIGHTED CHANNELIZERS ON ALL OTHER TYPES OF HIGHWAYS, DAY OR NIGHT. ON THESE ROADWAYS THE WEIGHTED CHANNELIZER MAY BE USED IN THE TRANSITION TAPERS AS WELL AS IN THE TANGENT AREAS, DAY OR NIGHT.

MAXIMUM SPACING OF THE WEIGHTED CHANNELIZER SHALL BE 40 FEET.

STEPS SHOULD BE TAKEN TO ENSURE THAT THE WEIGHTED CHANNELIZERS WILL NOT BE BLOWN OVER OR DISPLACED BY WIND OR MOVING TRAFFIC. BALLASTS SHOULD NOT PRESENT A HAZARD IF THE WEIGHTED CHANNELIZERS ARE INADVERTENTLY STRUCK, NOR SHOULD THEY AFFECT THE VISIBILITY OF THE WEIGHTED CHANNELIZERS. ALL BALLASTS USED SHOULD BE IN ACCORDANCE WITH THE MANUFACTURER'S SPECIFICATIONS.

ITEM 614, MAINTAINING TRAFFIC (LANES OPEN DURING HOLIDAYS OR SPECIAL EVENTS)

NO WORK SHALL BE PERFORMED AND ALL EXISTING LANES SHALL BE OPEN TO TRAFFIC DURING THE FOLLOWING DESIGNATED HOLIDAYS OR EVENTS:

CHRISTMAS	FOURTH OF JULY
NEW YEARS	LABOR DAY
MEMORIAL DAY	THANKSGIVING

THE PERIOD OF TIME THAT THE LANES ARE TO BE OPEN DEPENDS ON THE DAY OF THE WEEK ON WHICH THE HOLIDAY OR EVENT FALLS. THE FOLLOWING SCHEDULE SHALL BE USED TO DETERMINE THIS PERIOD:

DAY OF THE WEEK	TIME ALL LANES MUST BE OPEN TO TRAFFIC
SUNDAY	12:00N FRIDAY THROUGH 6:00 AM MONDAY
MONDAY	12:00N FRIDAY THROUGH 6:00 AM TUESDAY
TUESDAY	12:00N MONDAY THROUGH 6:00 AM WEDNESDAY
WEDNESDAY	12:00N TUESDAY THROUGH 6:00 AM THURSDAY
THURSDAY	12:00N WEDNESDAY THROUGH 6:00 AM MONDAY
FRIDAY	12:00N THURSDAY THROUGH 6:00 AM MONDAY
SATURDAY	12:00N FRIDAY THROUGH 6:00 AM MONDAY

NO EXTENSIONS OF TIME SHALL BE GRANTED FOR DELAYS IN MATERIAL DELIVERIES, UNLESS SUCH DELAYS ARE INDUSTRY-WIDE, OR FOR LABOR STRIKES, UNLESS SUCH STRIKES ARE AREA-WIDE.

SHOULD THE CONTRACTOR FAIL TO MEET ANY OF THESE REQUIREMENTS, THE CONTRACTOR SHALL BE ASSESSED LIQUIDATED DAMAGES IN ACCORDANCE WITH CMS 108.07.

CALCULATED
MJH
CHECKED

MAINTENANCE OF TRAFFIC GENERAL NOTES

STA -153/ 173-7.47 / 0.00

I:\Projects\STA\25581_153_0747\roadway\sheet\25581MD001.dgn 08-FEB-2008 10:20AM rbaughma

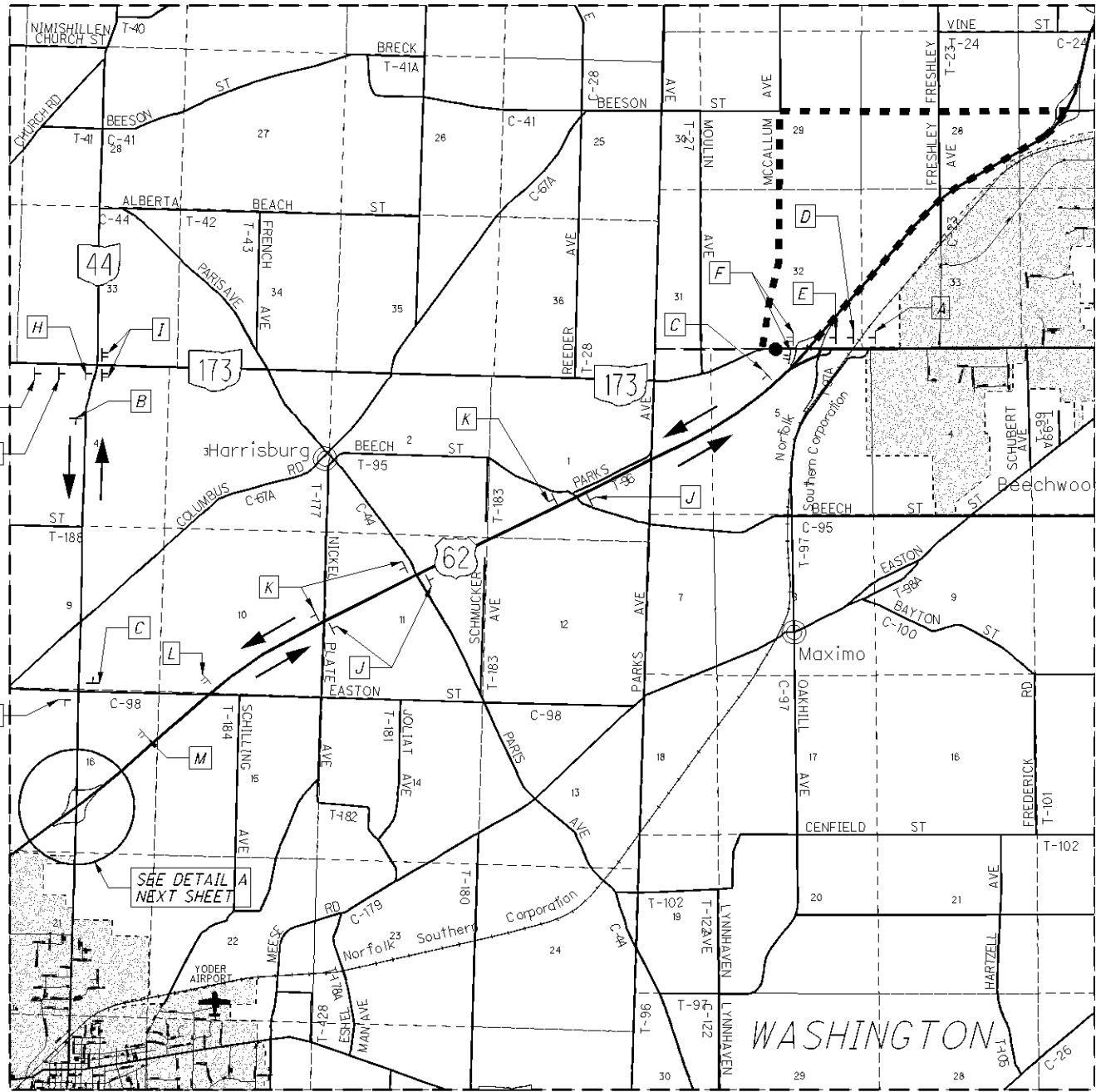

DETOUR PLAN FOR STA-173-0425



- CLOSE AS PER STD. DWG. MT-101.60
- ↑ OFFICIAL DETOUR ROUTE: SR-44 / US-62
- LOCAL ALTERNATE DETOUR ROUTE: MCCALLUM AVE. / BEESON ST. / US-62

LEGEND

<p>A</p> <p>W20-2-36</p>	<p>D</p> <p>MI-5-30-3</p>	<p>G</p> <p>MI-5-30-3</p>
<p>B</p> <p>EAST</p> <p>M3-2-24</p> <p>MI-5-30-3</p>	<p>E</p> <p>MI-5-30-3</p>	<p>H</p> <p>MI-5-30-3</p>
<p>C</p> <p>WEST</p> <p>M3-4-24</p> <p>MI-5-30-3</p>	<p>F #</p> <p>ROAD CLOSED MILES AHEAD LOCAL TRAFFIC ONLY</p> <p>R11-3A-60</p> <p>M4-10L-48</p>	<p>I #</p> <p>ROAD CLOSED MILES AHEAD LOCAL TRAFFIC ONLY</p> <p>R11-3A-60</p> <p>M4-10R-48</p>

ON TYPE III BARRICADE

NOTE: REFER TO THE OHIO MANUAL OF UNIFORM TRAFFIC CONTROL DEVICES, FIGURE 6H-8 (TYPICAL APPLICATION 8), FOR SIGN SPACING.

DETOUR PLAN FOR STA-173-0425

STA-153/173-7.47 / 0.00

CALCULATED MJH CHECKED

LEGEND (CONTINUED)

<p>J</p> <p>DETOUR M4-8-30</p> <p>EAST M3-2-36</p> <p>173 MI-5-45-3</p>	<p>M</p> <p>DETOUR M4-8-30</p> <p>173 MI-5-45-3</p> <p>44 Louisville East Canton EXIT 1/2 MILE</p>	<p>O</p> <p>DETOUR M4-8-30</p> <p>173 MI-5-45-3</p> <p>M6-2R-30</p> <p>EXIT</p>
<p>K</p> <p>DETOUR M4-8-30</p> <p>WEST M3-4-36</p> <p>173 MI-5-45-3</p>	<p>L</p> <p>DETOUR M4-8-30</p> <p>173 MI-5-45-3</p> <p>M6-2R-30</p> <p>44 Louisville East Canton EXIT 1 MILE</p>	<p>N</p> <p>DETOUR M4-8-30</p> <p>173 MI-5-45-3</p> <p>M6-2R-30</p> <p>44 Louisville East Canton</p>

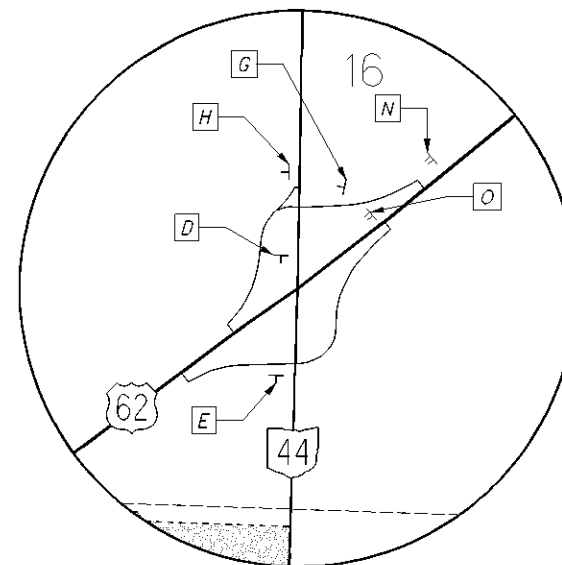

DETAIL A



NOT TO SCALE

GENERAL NOTES

1. It is intended that this drawing be used for treatment of drop-offs that develop during construction operations, and that are not otherwise provided for in the construction plans. Where the plans do not provide specific items for labor, equipment, or materials to implement the drop-off treatments specified herein, they shall be included for payment in the lump sum bid for Item 614 - Maintaining Traffic.

2. While the need for certain advisory signing is noted herein, it is not intended that this be indicative of all signing that may be required to advise or warn motorist, and all requirements of the Ohio Manual of Uniform Traffic Control Devices (OMUTCD) must be fulfilled.

3. In urban or otherwise heavily developed areas where pedestrians and/or bicyclists may be present in significant numbers, additional signing and protective measures other than those shown herein may be required.

4. The drop-off treatment selected for use at any given location shall be appropriate for the prevailing conditions at the site.

5. Where concrete barrier is specified, it shall be in accordance with Standard Construction Drawing PCB - 9.1, RM-4.2 and Item 622.

6. When drums are specified for a drop-off condition, a minimum number of four drums shall be used. Spacing shall be as indicated in the plans or as specified in the OMUTCD.

7. When W8-9 (Low Shoulder) signs or W8-11 (Uneven Lanes) and R4-9 (Stay in Lane) signs are required, they shall be placed 750' in advance of the condition, on all intersecting entrance ramps within the limits of the condition and immediately beyond all intersecting roadways within the limits of the condition. When the drop-off condition extends more than one-half mile, additional signs shall be erected at intervals of a maximum of one mile.

8. For locations, such as at ramps, lane shifts, lane closures, etc., where traffic is required to negotiate any difference in elevation between pavements, the Optional Wedge Treatment shall be provided.

9. Portable concrete barrier shall be placed on the same level as the traffic surface and shall not encroach on lane width(s) designated as the minimum required for traffic use. Where drums are used, and their presence would reduce traveled lane widths to less than 10', drums may be placed on the opposite level from that of traffic provided the drop-off depth does not exceed 5" and approval is granted by the Project Engineer.

10. Pavement Repairs (or similar work):

a. Lengths greater than 60 feet - utilize appropriate treatment from Condition I.

b. Lengths of 60 feet or less - repairs shall be affected in accordance with Item 255.08. Drums may be used as a separator adjacent to the traveled lane.

CONDITION I

1. These treatments are to be used for resurfacing, pavement planing excavation, etc., between, beside or within traveled lanes.

Distance From Traveled Lane	D (in)	Treatment
1FT-12FT	$\leq 1/2$	Erect W8-11.
1FT-12FT	$1/2-3$	1. Lane closure utilizing drums* as shown below. (use only on 3 or more lanes) - or - 2. Optional Wedge Treatment.
1FT-12FT	3 - 5	Lane closure utilizing drums as shown below
1FT-12FT	5 - 12	Lane closure utilizing portable concrete barrier as shown below.
>12FT-20FT	12 - 24	Lane closure utilizing drums as shown below
>12FT-20FT	>24	Lane closure utilizing portable concrete barrier as shown below.

*Cones may be used for daytime only conditions.

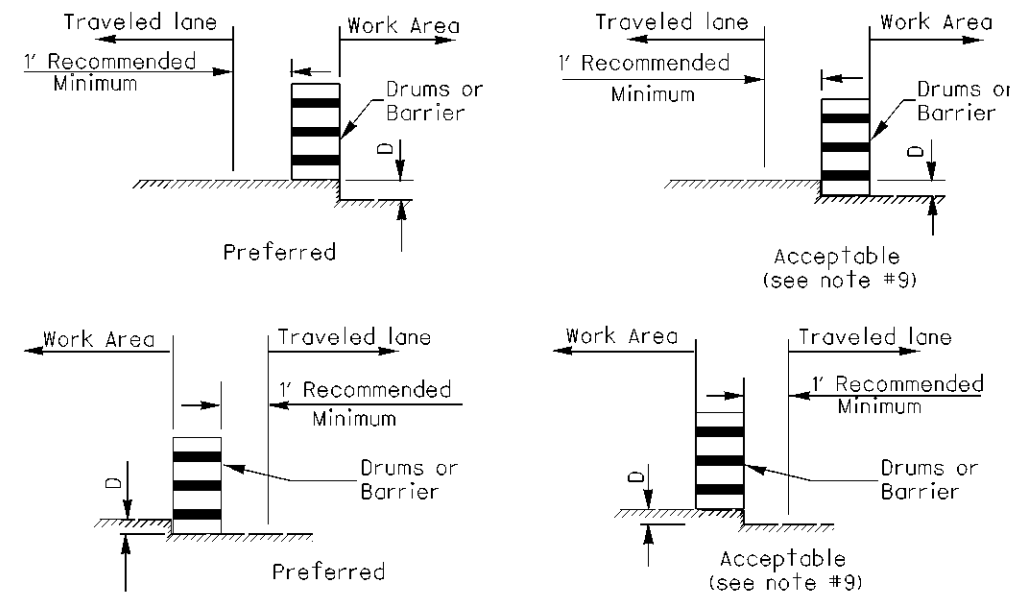

OPTIONAL WEDGE TREATMENT

(MILLING OR RESURFACING)

1. This treatment may be used when permitted for Condition I only.
2. W8-11 and R4-9 signs required.

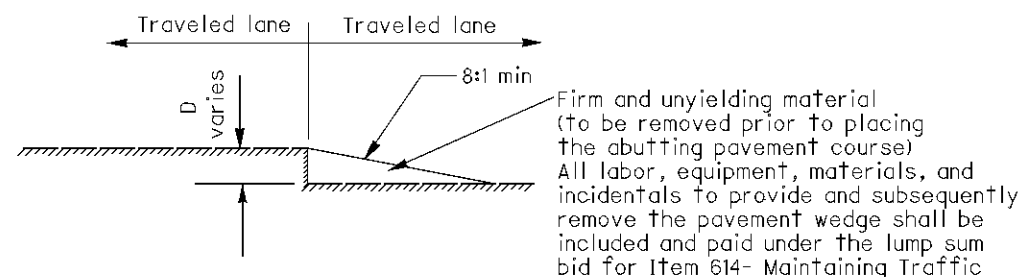

CONDITION II

DROPOFFS WITHIN GRADED SHOULDER AREA
[except for linear grading areas]

The treatments indicated below are for use in conjunction with resurfacing, planing, or excavation within the graded shoulder area.

Distance From Traveled Lane	D (in)	Treatment
1FT-12FT	$\leq 1/2$	1.) If edgelines are present, no treatment necessary. or 2.) Erect W8-11 and R4-9 signs
1FT-12FT	$1/2-5$	1) If min. lane widths* requirements can be met, maintain lanes utilizing drums as shown below. - or - 2) If min. lane width* requirements cannot be met, close adjacent lane utilizing drums. (use only on 3 or more lanes) - or - 3) Optional shoulder treatment
>12FT-30FT	≤ 24	Shoulder closure utilizing drums as shown below
>12FT-30FT	>24	Shoulder closure utilizing portable concrete barrier as shown below.

*Minimum lane widths shall be 10' unless otherwise specified in the plans.

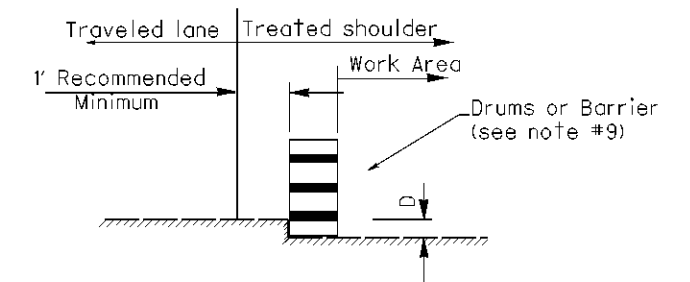

OPTIONAL SHOULDER TREATMENT

1. This treatment shall not be used within a bituminous shoulder where a hot longitudinal joint per 401.17 is required.
2. W8-9 signs required.

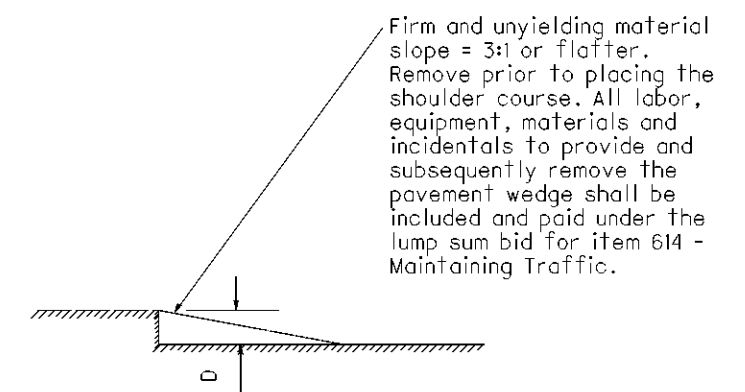

I:\Projects\STA\25581_153_0747\roadway\sheets\25581G001.dgn 19-MAR-2008 12:34PM rbaughma

SHEET NUMBER												ITEM	ITEM EXT.	GRAND TOTAL	UNIT	DESCRIPTION	SEE SHEET NO.
							3	4	11	12	13						
												ROADWAY					
												201	11000	LUMP		CLEARING AND GRUBBING	
												202	23500	4823	SO YD	WEARING COURSE REMOVED	
												202	38000	375	FT	GUARDRAIL REMOVED	
												202	54000	467	EACH	RAISED PAVEMENT MARKER REMOVED	
												203	40000	15	CU YD	BORROW	
												604	39500	23	EACH	MONUMENT BOX ADJUSTED TO GRADE	
												606	13000	75	FT	GUARDRAIL, TYPE 5	
												606	22010	6	EACH	ANCHOR ASSEMBLY, TYPE E-98	
												SPECIAL	69050100	5	EACH	MAILBOX SUPPORT SYSTEM, SINGLE	4
												EROSION CONTROL					
												659	10000	198	SO YD	SEEDING AND MULCHING	
												659	20000	0.03	TON	COMMERCIAL FERTILIZER	
												659	31000	0.04	ACRE	LIME	
												659	35000	2	M GAL	WATER	
												832	30000	1000	EACH	EROSION CONTROL	
												PAVEMENT					
												251	01000	700	SO YD	PARTIAL DEPTH PAVEMENT REPAIR	
												254	01000	32563	SO YD	PAVEMENT PLANING, ASPHALT CONCRETE	
												254	01001	84541	SO YD	PAVEMENT PLANING, ASPHALT CONCRETE, AS PER PLAN	3
												254	01010	56	SO YD	PAVEMENT PLANING, PORTLAND CEMENT CONCRETE	
												407	10000	18624	GALLON	TACK COAT	
												407	14000	4975	GALLON	TACK COAT FOR INTERMEDIATE COURSE	
												408	10001	6289	GALLON	PRIME COAT, AS PER PLAN	3
												422	10001	32563	SO YD	SINGLE CHIP SEAL WITH POLYMER BINDER, AS PER PLAN	4
												446	46050	3671	CU YD	ASPHALT CONCRETE INTERMEDIATE COURSE, TYPE 2, PG64-22	
												446	47028	4524	CU YD	ASPHALT CONCRETE SURFACE COURSE, TYPE 1, PG70-22M	
												448	46020	80	CU YD	ASPHALT CONCRETE INTERMEDIATE COURSE, TYPE 1, PG64-22	
												448	48020	164	CU YD	ASPHALT CONCRETE SURFACE COURSE, TYPE 1, PG64-22 (DRIVEWAYS)	
												617	10101	873	CU YD	COMPACTED AGGREGATE, AS PER PLAN	3
												TRAFFIC CONTROL					
												621	10000	451	EACH	RPM, LOW PROFILE, YELLOW/YELLOW	
												621	10010	16	EACH	RPM, LOW PROFILE, WHITE	
												626	00100	12	EACH	BARRIER REFLECTOR, TYPE A	
												646	10001	14.61	MILE	EDGE LINE, AS PER PLAN	3
												646	10101	0.15	MILE	LANE LINE, AS PER PLAN	3
												646	10201	7.28	MILE	CENTER LINE, AS PER PLAN	3
												646	10301	652	FT	CHANNELIZING LINE, AS PER PLAN	3
												646	10401	58	FT	STOP LINE, AS PER PLAN	3
												646	10601	136	FT	TRANSVERSE/DIAGONAL LINE, AS PER PLAN	3
												646	10801	141	SO FT	ISLAND MARKING, AS PER PLAN	3
												646	20111	2	EACH	SCHOOL SYMBOL MARKING, 96", AS PER PLAN	3
												646	20301	7	EACH	LANE ARROW, AS PER PLAN	3
												646	10000	14.61	MILE	EDGE LINE - (POLYCARB) - ALTERNATE BID	3
												646	10100	0.15	MILE	LANE LINE - (POLYCARB) - ALTERNATE BID	3
												646	10200	7.28	MILE	CENTER LINE - (POLYCARB) - ALTERNATE BID	3
												646	10300	652	FT	CHANNELIZING LINE - (POLYCARB) - ALTERNATE BID	3
												646	10400	58	FT	STOP LINE - (POLYCARB) - ALTERNATE BID	3
												646	10600	136	FT	TRANSVERSE/DIAGONAL LINE - (POLYCARB) - ALTERNATE BID	3
												646	10800	141	SO FT	ISLAND MARKING - (POLYCARB) - ALTERNATE BID	3
												646	20110	2	EACH	SCHOOL SYMBOL MARKING, 96" - (POLYCARB) - ALTERNATE BID	3
												646	20300	7	EACH	LANE ARROW - (POLYCARB) - ALTERNATE BID	3

GENERAL SUMMARY

STA - 153 / 173 - 7.47 / 0.00

SHEET NUMBER													ITEM	ITEM EXT.	GRAND TOTAL	UNIT	DESCRIPTION	SEE SHEET NO.				
											5								STRUCTURES	21		
																				FOR STRUCTURES STA-173-0315 AND STA-173-0425 ESTIMATED QUANTITIES		
																				MAINTENANCE OF TRAFFIC		
													614	12420	LUMP		DETOUR SIGNING					
													32	614	12460	32	EACH	WORK ZONE MARKING SIGN				
													20	614	13000	20	CU YD	ASPHALT CONCRETE FOR MAINTAINING TRAFFIC				
													0.15	614	20400	0.15	MILE	WORK ZONE LANE LINE, CLASS II				
													20.14	614	21400	20.14	MILE	WORK ZONE CENTER LINE, CLASS II				
													652	614	23000	652	FT	WORK ZONE CHANNELIZING LINE, CLASS I				
													112	614	26000	112	FT	WORK ZONE STOP LINE, CLASS I				
													614	11000	LUMP		MAINTAINING TRAFFIC					
													619	16010	5	MONTH	FIELD OFFICE, TYPE B					
													623	10000	LUMP		CONSTRUCTION LAYOUT STAKES					
													624	10000	LUMP		MOBILIZATION					

GENERAL SUMMARY

STA - 153 / 173 - 7.47 / 0.00

I:\Projects\STA\25581_153_074\roadway\sheets\25581\CP001.dgn 08-FEB-2008 10:21AM rbaughma

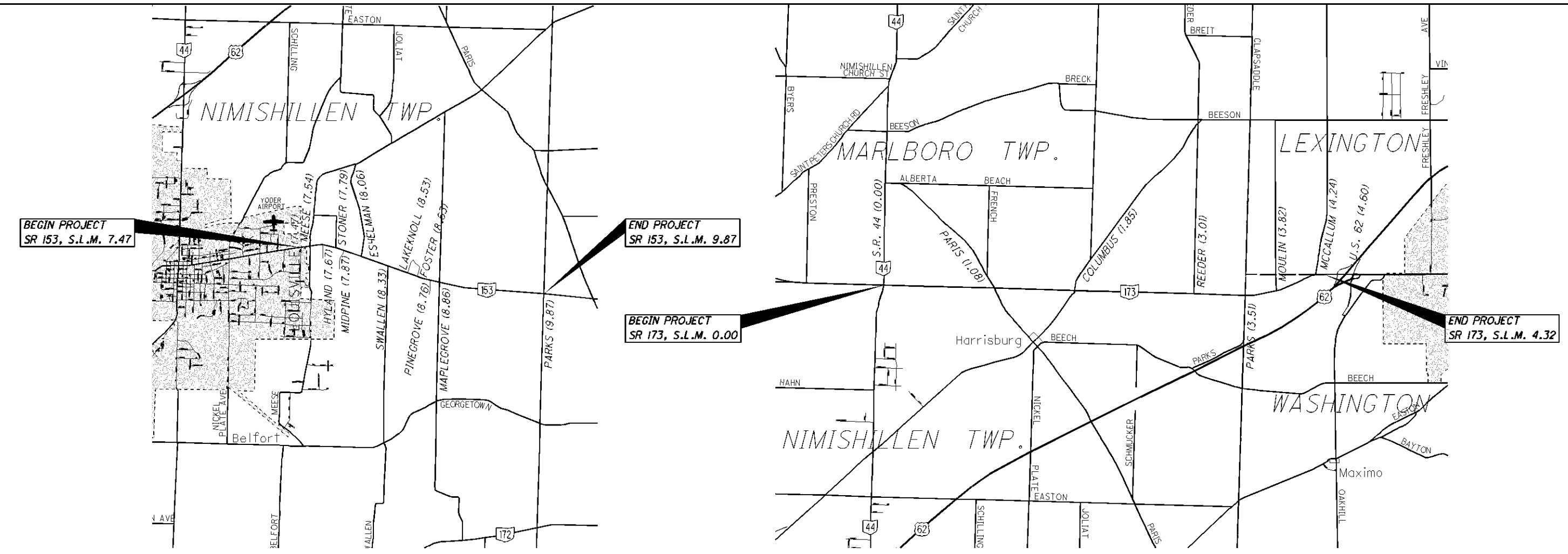

ROUTE	SLM TO SLM		SIDE	LENGTH	AVERAGE	SURFACE	CADD/CALC.	202, WEARING COURSE REMOVED	254, (1 1/2") PAV'T. PLANING, ASP. CONC.	254, (1 1/2") PAV'T. PLANING, ASP. CONC., APP	407, TACK COAT 0.075x4	407, TACK COAT 0.15x4	407, TACK COAT FOR INT. COURSE 0.04x4	407, TACK COAT FOR INT. COURSE 0.1x4	422, SINGLE CHIP SEAL WITH POLYMER BINDER, AS PER PLAN	446, (1 1/4") ASP. CONC. SURF. TYPE 1, PG70-22M (1.25x4)/36	446, (1 1/2") ASP. CONC. SURF. TYPE 1, PG70-22M (1.5x4)/36	446, (1 3/4") ASP. CONC. INT. TYPE 2, PG64-22 (1.75x4)/36	448, ASP. CONC. SURF. TYPE 1, PG64-22 (DRIVEWAYS) (Avg. Depth x4)/36	408, PRIME COAT, AS PER PLAN (0.4x2x4)/1/9	617, COMPACTED AGGREGATE, AS PER PLAN (2x2x2x4)/1(12x27)	
	FT	FT		SQ YD	SQ YD	SQ YD	SQ YD															GAL
SR 153	7.47	9.87	LT./RT.	12672.00	29	40832.00				40832.00		6124.80	1633.28			1417.78		1984.89		2252.80	312.89	
SR 173	0.00	1.72	LT./RT.	9081.60	31.5	31785.60			31785.60			4767.84		3178.56	31785.60	1103.67		1545.13		1614.51	224.24	
SR 173	1.72	1.98	LT./RT.	1372.80	29.25	4461.60					334.62	6092.68				154.92				244.05	33.90	
SR 173	1.98	4.25	LT./RT.	11985.60	30.5	40617.87				40617.87		6092.68				1692.41				2130.77	295.94	
SR 173	4.27	4.32	LT./RT.	264.00	30.5	894.67				894.67		134.20				37.28				46.93	6.52	
SR 153	INTERSECTIONS							2127.78			2127.78		319.17	85.11			73.88		103.43			
SR 173	INTERSECTIONS (0.00 TO 1.72)							777.78		777.78			116.67		77.78	777.78	27.01		37.81			
SR 173	INTERSECTIONS (1.72 TO 1.98)							416.00	416				62.40				14.44					
SR 173	INTERSECTIONS (1.98 TO 4.32)							68.44			68.44		10.27					2.85				
SR 153	DRIVEWAYS							2705.56	2705.56				405.83								93.94	
SR 173	DRIVEWAYS							1152.22	1152.22				172.83								40.01	
SR 153	MAILBOX APPROACHES							171.90	171.90				25.79								9.55	
SR 173	MAILBOX APPROACHES							377.07	377.07				56.56								20.95	
TOTALS CARRIED TO GENERAL SUMMARY								4823	32563	84541	18624		4975	32563	4524	3671	164	6289	873			

ASPHALT CONCRETE SHEET

SLM 7.47 TO SLM 9.87, SR 153 & SLM 0.00 TO SLM 4.32, SR 173

STA-153/173-7.47/0.00

CALCULATED	RCB
CHECKED	TJP

11
23

RPM REPLACEMENT / REMOVAL

STANDARD CONSTRUCTION DWG.

TC-65.10	1-21-05	
TC-65.11	1-21-05	

CALCULATED
KG
CREATED
DY

PID
25581

LOCATION				ITEM 202	ITEM 621				REMARKS
COUNTY	ROUTE	SECTION (S.L.M.)		RAISED PAVEMENT MARKER REMOVED	RPM LOW PROFILE YELLOW/YELLOW	RPM LOW PROFILE WHITE/RED	RPM LOW PROFILE ONE-WAY WHITE	RPM LOW PROFILE YELLOW/RED	
		FROM	TO						
	153	7.47	9.87	165	165				SR 153 E.B. (CENTER LINE)
	173	0.00	4.32	302	286		16		SR 173 E.B. FROM SR 44 (CENTER LINE AND STOP APPROACH)
TOTAL				467	451		16		TOTALS CARRIED TO GENERAL SUMMARY

RAISED PAVEMENT MARKER SUB SUMMARY

STA - 153 / 173 - 7.47 / 0.00

I:\Projects\STA\25581_153_0747\roadway\sheets\25581RPM.dgn 08-FEB-2008 10:21AM rbaughma

CENTER LINE

GENERAL SPEC: 640
MATERIAL TYPE: 646

CTY	ROUTE	TRUE LOG	FROM	TRUE LOG	TO	TOTAL MILES	EQUIVALENT SOLID LINE		COMMENTS
STA	153	7.47	LOUISVILLE EAST CORP.	9.87	JCT. PARKS AVE.	2.40	2.87		
STA	173	0.00	JCT. SR 44	4.80	JCT. US 62 RAMPS	4.88	7.13		
TOTAL						7.28	10.00		

LANE LINE

CTY	ROUTE	TRUE LOG	FROM	TRUE LOG	TO	TOTAL MILES	4" LANE LINE		COMMENTS
							DASHED	SOLID	
STA	173	4.45	SR 173 EB @ US 62 WB ON RAMP	4.60	SR 173 EB @ US 62 EB OFF RAMP	0.10			
STA	173	4.55	SR 173 WB @ BEGIN CHANNEL . LINE	4.60	SR 173 WB TO SR 225	0.05			
TOTAL						0.15			

EDGE LINE

CTY	ROUTE	TRUE LOG	FROM	TRUE LOG	TO	WHITE EDGE LINE			YELLOW EDGE LINE			COMMENTS
						TOTAL	HIGHWAY	RAMP	TOTAL	HIGHWAY	RAMP	
						STA	153	7.47	LOUISVILLE EAST CORP.	9.87	JCT. PARKS AVE.	
STA	173	0.00	JCT. SR 44	4.80	JCT. US 62 RAMPS	9.60	9.60		0.21	0.21		
TOTAL						14.40	14.40		0.21	0.21		

AUXILIARY

CTY	ROUTE LOCATION	TRUE LOG	CHANNEL LINE	STOP LINE	TRANSVERSE DIAGONAL LINES		CROSS WALK LINES	WORD ON PVMT ONLY		LANE ARROWS				SYMBOL MARKINGS		ISLAND MARKING	DOTTED LINES	COMMENTS	
					WHITE	YELLOW		72"	96"	TURN LEFT	TURN RIGHT	THRU	COMB.	RxR	SCHOOL				
					FT	FT		FT	FT	EACH	EACH	EACH	EACH	EACH	EACH				72"
STA	SR 153 @ MAPLEGROVE ELEM	8.685																	
STA	SR 173 @ SR 44	0.000		18															
STA	SR 173 @ US 62 RAMPS	4.492	652	40	70	66				5	2					141			
TOTAL			652	58	136					7				2		141			

CALCULATED
TJD
CHECKED

PAVEMENT MARKING SUB-SUMMARY

STA -153 / 173-7.47 / 0.00

I:\Projects\STA\25581_153_0747\roadway\sheets\25581TS001.dgn 08-FEB-2008 10:21AM rbaughma

ODOT Dist 4 - Stark County - FINAL
No Passing Zone Log (STA)

Route: 0153R (SSTASR00153**C) From: 3.290 RICHMOND
Length: 11.736 Direction: East To: 15.026 S0183R

Length Left C/L Right Length Control Points Scale: 1.00 mile/page

Length	Left	C/L	Right	Length	Control Points
0.190	8.000		8.000	0.190	7.900 C0179 MEESE LT
	7.810		7.810		7.810 LEAVE LOUISVILLE

↑ 45mp

ODOT Dist 4 - Stark County - FINAL
No Passing Zone Log (STA)

Route: 0153R (SSTASR00153**C) From: 3.290 RICHMOND
Length: 11.736 Direction: East To: 15.026 S0183R

Length Left C/L Right Length Control Points Scale: 1.00 mile/page

Length	Left	C/L	Right	Length	Control Points
0.129	8.925		9.000	0.129	8.987 FOSTER LT
			8.871		8.892 LAKEKNOLL LT
0.118	8.697		8.748	0.118	8.692 T0178 SWALLEN RT
			8.630		
0.489	8.489		8.414	0.489	8.419 T0178A ESHELMAN LT
			8.255		8.255
0.414	8.000		8.000	0.414	8.230 MIDPINE RT
					8.020 HYLAND RT

↑ 55mp

Sheet total equivalent length of solid line: 0.380

Accum. total: 4.868

© 2004 - MasterMind Systems, Inc. - Traffic Safety Suite

Sheet total equivalent length of solid line: 1.498

Accum. total: 6.366

© 2004 - MasterMind Systems, Inc. - Traffic Safety Suite

I:\Projects\STA\25581_153_0747\25581\roadway\sheets\25581\5001.dgn 08-FEB-2008 10:21AM rbaughma

PAVEMENT MARKING DETAILS

STA -153/ 173-7.47 / 0.00

ODOT District 4
No Passing Zone Log (STA)

Page: 1 of 2
9 15

Route: 0153R (SSTASR00153**C)
Length: 1.000 Direction: East

From: 9.000 LEAVE CANTON
To: 10.000 S0183R

Scale: 1.00 mile/page

Length	Left	C/L	Right	Length	Control Points
0.044	10.000				
	9.956				
			9.911		
				0.125	9.870 PARK AVE.
			9.786		
	9.628				
0.176					
	9.452		9.458		
				0.458	9.215 T0180 MAPLEGROVE
	9.216				
0.129					
	9.087				9.123 T2831 PINE GROVE RT
			9.000		

COUNTY: STARK
 LOCATION: SR 153 @ MAPLEGROVE ELEM. SCHOOL
 S.L.M.: 8.685

24" STOP LINE L.F.
 12" CROSSWALK LINE L.F.
 DOTTED LINE L.F.
 8" CHANNELIZING LINE L.F.
 24" TRANSVERSE LINE (WH) L.F.
 24" TRANSVERSE LINE (YW) L.F.
 SYMBOLS 2 - SCHOOL SYMBOLS

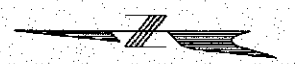
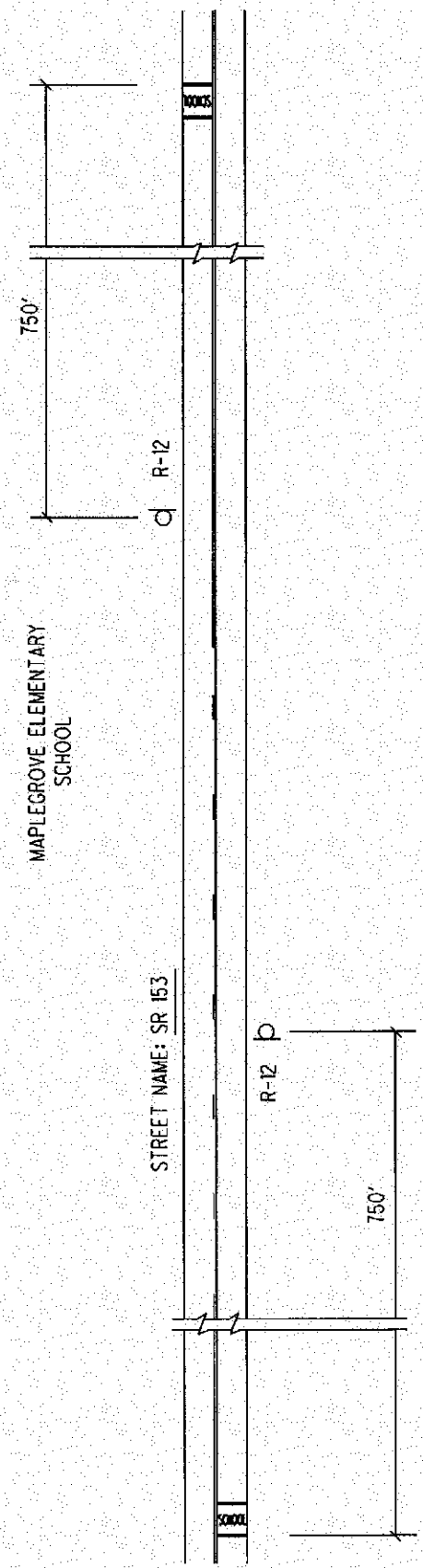
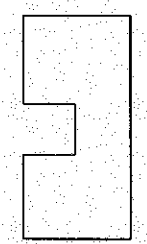

Sheet total equivalent length of solid line: 1.148

Accum. total: ~~1.148~~
1.514

© 2007 - MasterMind Systems, Inc. - Traffic Safety Suite

I:\Projects\STA\25581_153_0747\25581\roadway\sheets\25581\5001.dgn 08-FEB-2008 10:21AM rbaughtma

ODOT Dist 4 - Stark County - FINAL
No Passing Zone Log (STA)

Route: 0173R (SSTASR00173**C) From: 0.000 S0044R
Length: 4.408 Direction: East To: 4.408 U0062R RAMPS

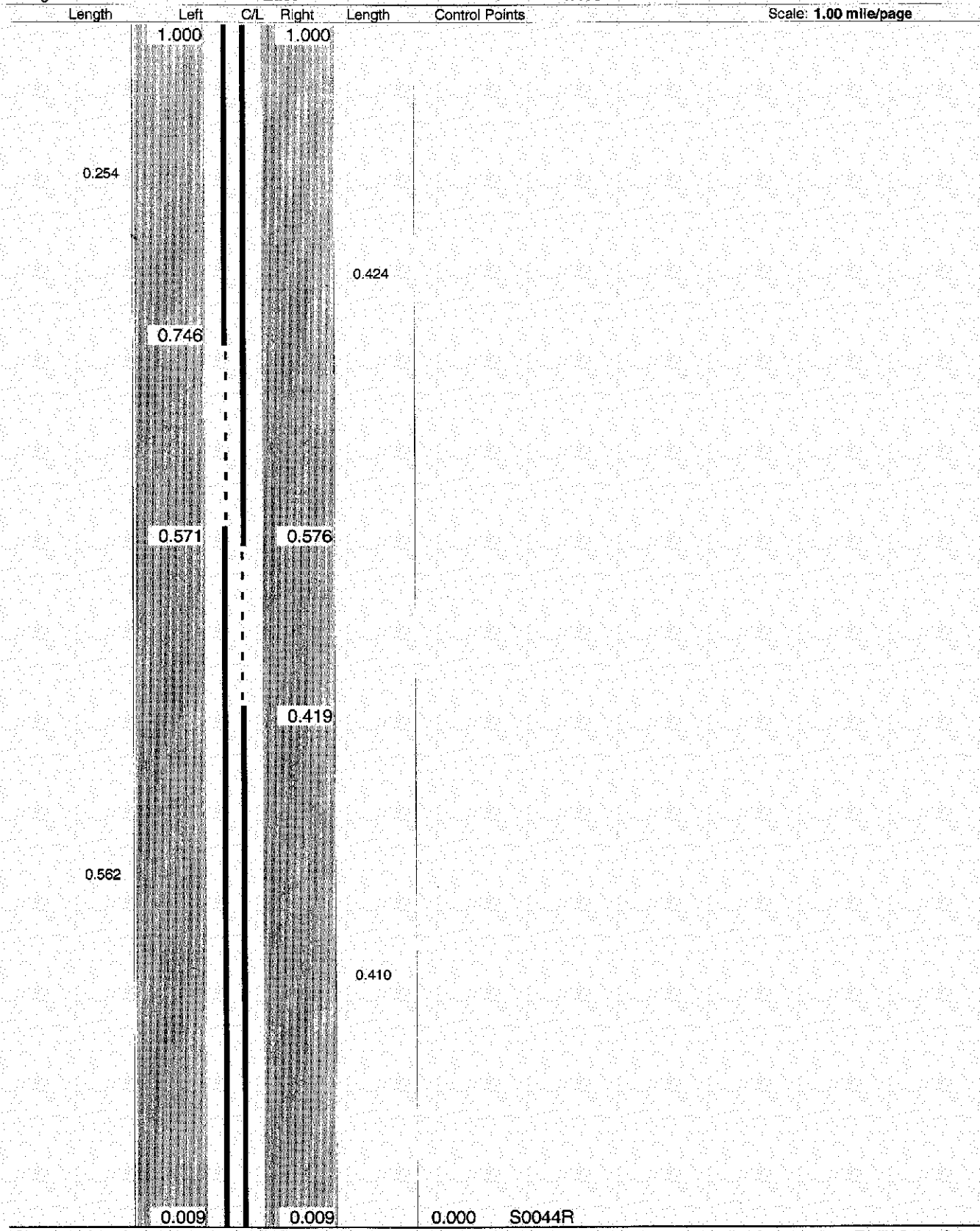

Sheet total equivalent length of solid line: 1.734 Accum. total: 1.734 © 2004 - MasterMind Systems, Inc. - Traffic Safety Suite

ODOT Dist 4 - Stark County - FINAL
No Passing Zone Log (STA)

Route: 0173R (SSTASR00173**C) From: 0.000 S0044R
Length: 4.408 Direction: East To: 4.408 U0062R RAMPS

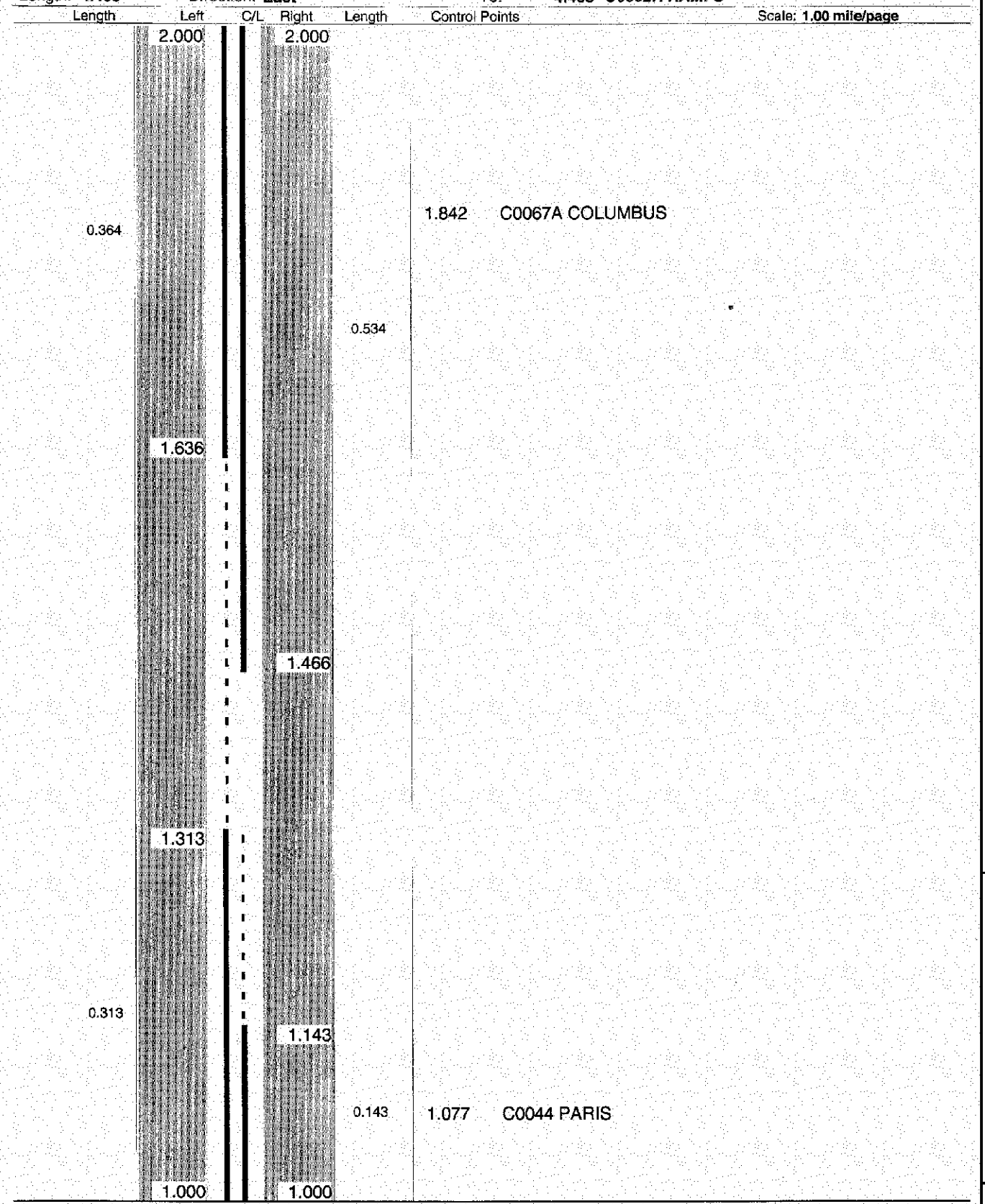

Sheet total equivalent length of solid line: 1.477 Accum. total: 3.211 © 2004 - MasterMind Systems, Inc. - Traffic Safety Suite

PAVEMENT MARKING DETAILS

STA -153/ 173-7.47 / 0.00

I:\Projects\STA\25581_153_0747\roadway\sheets\25581\25581.dgn 08-FEB-2008 10:21AM rbaughma

ODOT Dist 4 - Stark County - FINAL
No Passing Zone Log (STA)

Route: 0173R (SSTASR00173**C) From: 0.000 S0044R
Length: 4.408 Direction: East To: 4.408 U0062R RAMPS

Length Left C/L Right Length Control Points Scale: 1.00 mile/page

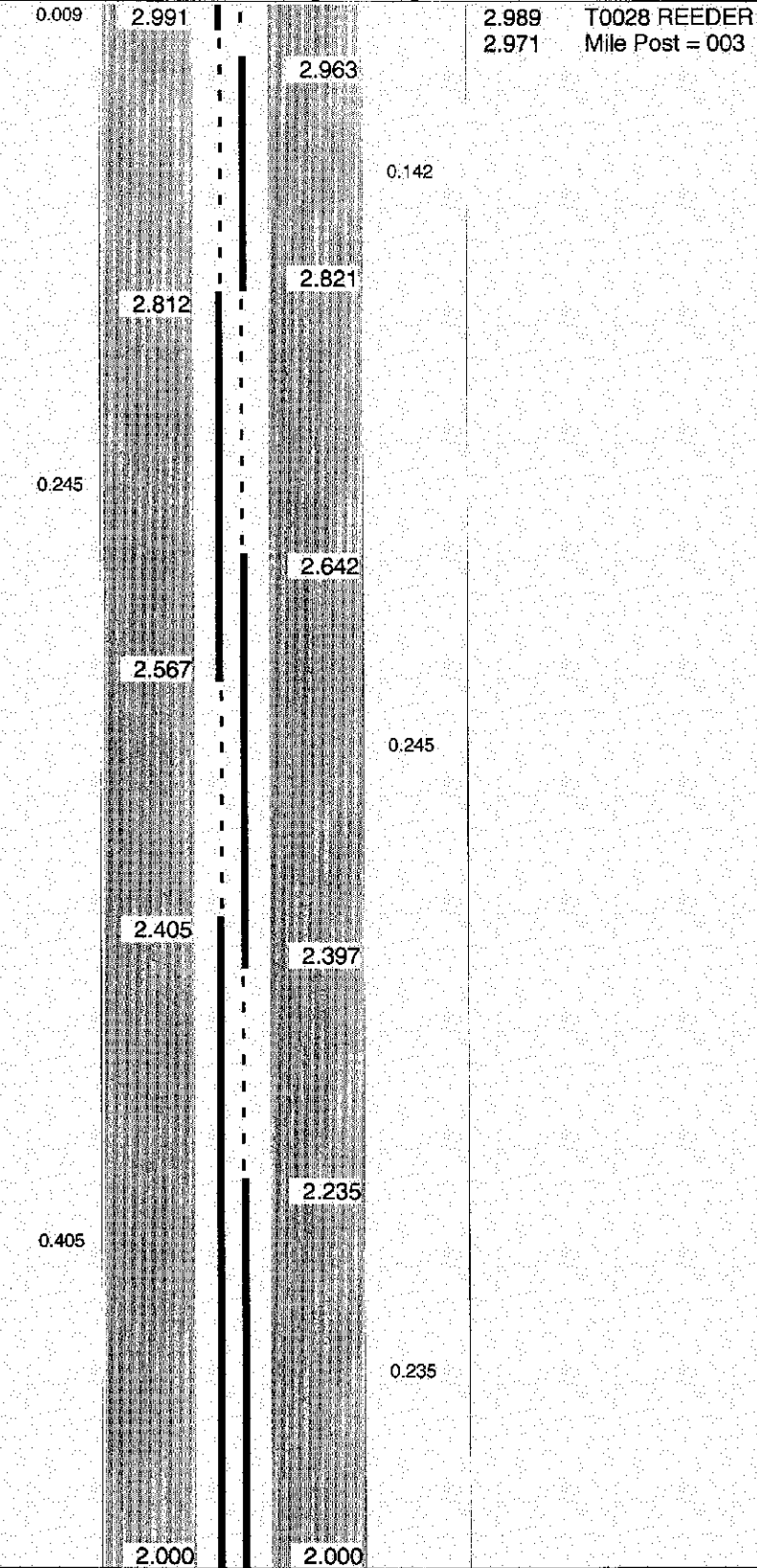

Sheet total equivalent length of solid line: 1.452 Accum. total: 4.663 © 2004 - MasterMind Systems, Inc. - Traffic Safety Suite

ODOT Dist 4 - Stark County - FINAL
No Passing Zone Log (STA)

Route: 0173R (SSTASR00173**C) From: 0.000 S0044R
Length: 4.408 Direction: East To: 4.408 U0062R RAMPS

Length Left C/L Right Length Control Points Scale: 1.00 mile/page

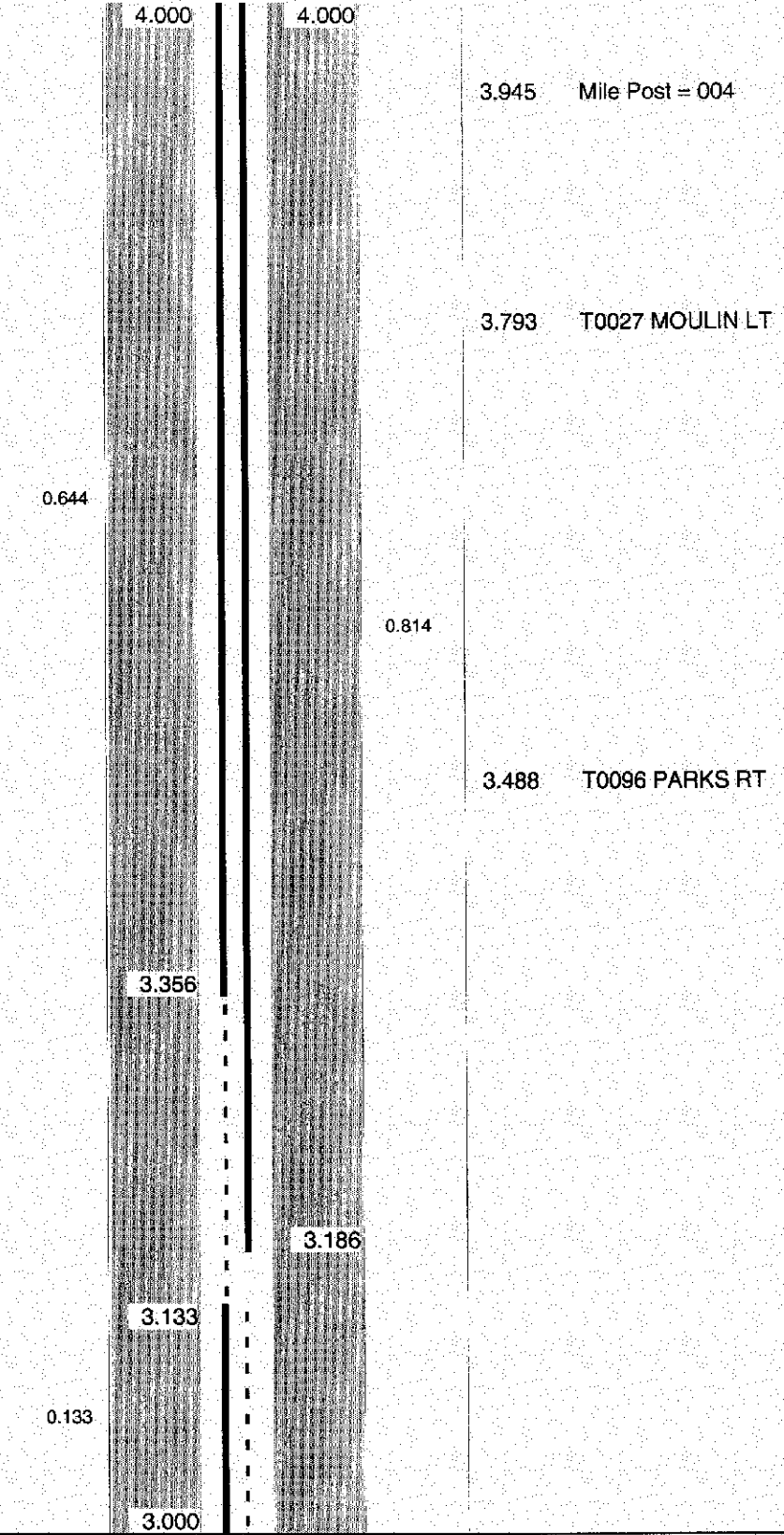

Sheet total equivalent length of solid line: 1.680 Accum. total: 6.343 © 2004 - MasterMind Systems, Inc. - Traffic Safety Suite

I:\Projects\STA\25581_153_074\25581\roadway\sheets\25581\25001.dgn 08-FEB-2008 10:21AM rbaughma

PAVEMENT MARKING DETAILS

STA - 153 / 173 - 7.47 / 0.00

ODOT Dist 4 - Stark County - FINAL
No Passing Zone Log (STA)

Route: 0173R (SSTASR00173**C) From: 0.000 S0044R
Length: 4.408 Direction: East To: 4.408 U0062R RAMPS

Length Left C/L Right Length Control Points Scale: 1.00 mile/page

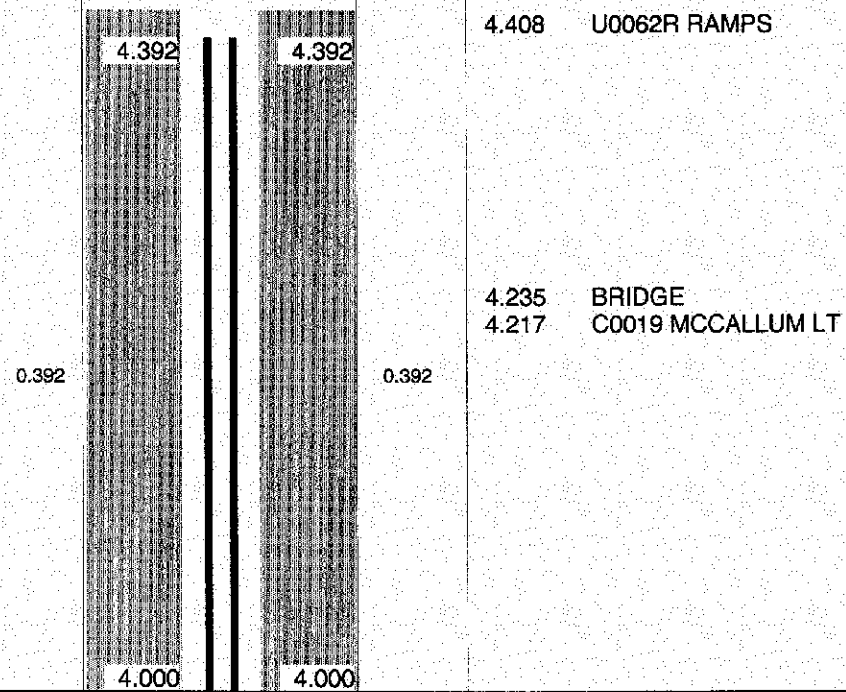

Sheet total equivalent length of solid line: 0.784

Accum. total: 7.127

© 2004 - MasterMind Systems, Inc. - Traffic Safety Suite

AUXILIARY PAVEMENT MARKING

COUNTY: STARK
 LOCATION: SR 173 & SR 44
 PAVEMENT SURFACE TYPE: 0.000
 INTERSECTION TOTALS
 24" STOP LINE _____ LIN. FT.
 12" CROSSWALK LINE _____ LIN. FT.
 8" CHANNELIZING LINE _____ LIN. FT.
 SYMBOLS and LEGENDS _____
 24" TRANSVERSE LINE _____ LIN. FT.

STREET NAME: SR 173

STREET NAME: SR 44

STREET NAME: STATE ST.

I:\Projects\STA\25581_153_074\25581\roadway\sheets\25581\5001.dgn 08-FEB-2008 10:22AM rbaughma

COUNTY: STARK 1 OF 2
 LOCATION: SR 173 @ US 62 RAMPS
 S.L.M.: 4.492
 24" STOP LINE L.F.
 12" CROSSWALK LINE L.F.
 DOTTED LINE L.F.
 8" CHANNELIZING LINE L.F.
 24" TRANSVERSE LINE (WH) L.F.
 24" TRANSVERSE LINE (YW) L.F.
 SYMBOLS

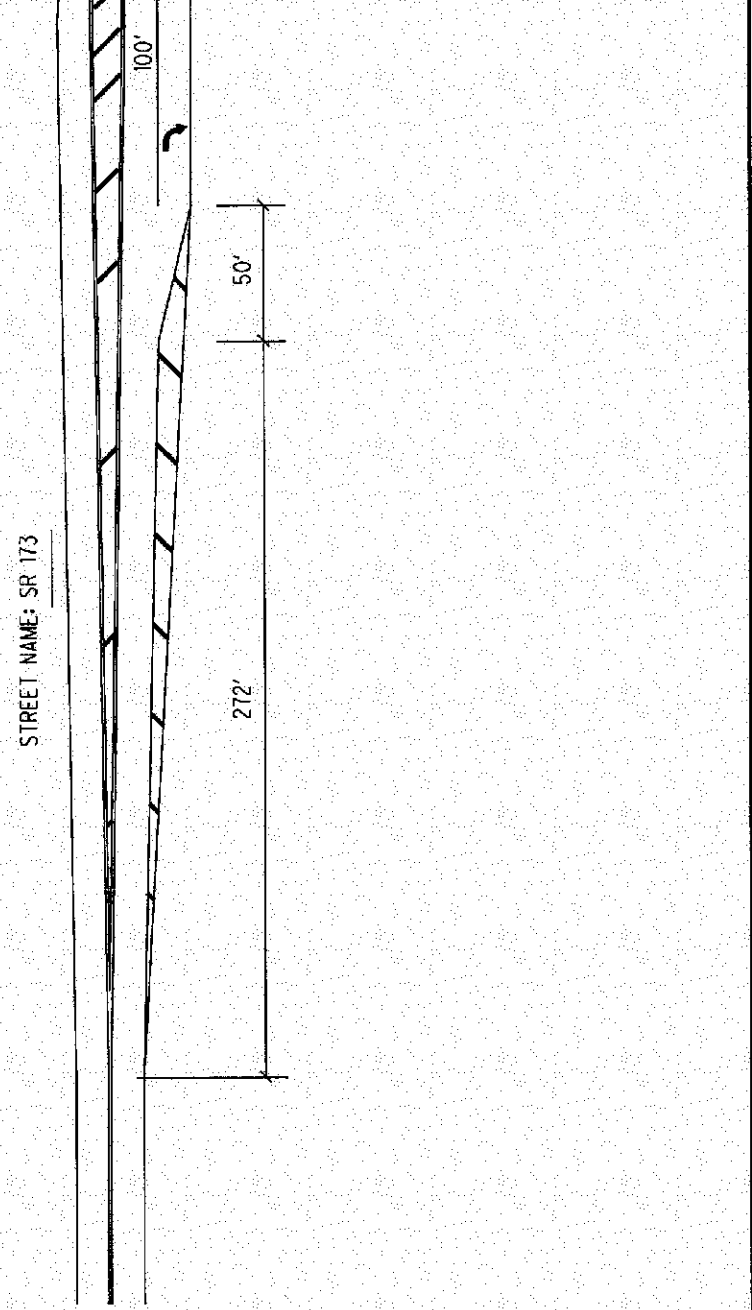

...|STA|173|SR173-4.49.DGN 12/14/2007 2:36:43 PM

COUNTY: STARK 2 OF 2
 LOCATION: SR 173 @ US 62 RAMPS
 S.L.M.: 4.492
 24" STOP LINE 40 L.F.
 12" CROSSWALK LINE L.F.
 ISLAND MKG'S 141 L.F.
 8" CHANNELIZING LINE 652' L.F.
 24" TRANSVERSE LINE (WH) 70 L.F.
 24" TRANSVERSE LINE (YW) 66 L.F.
 SYMBOLS 5-LT. ARROWS 2- RIGHT ARROWS

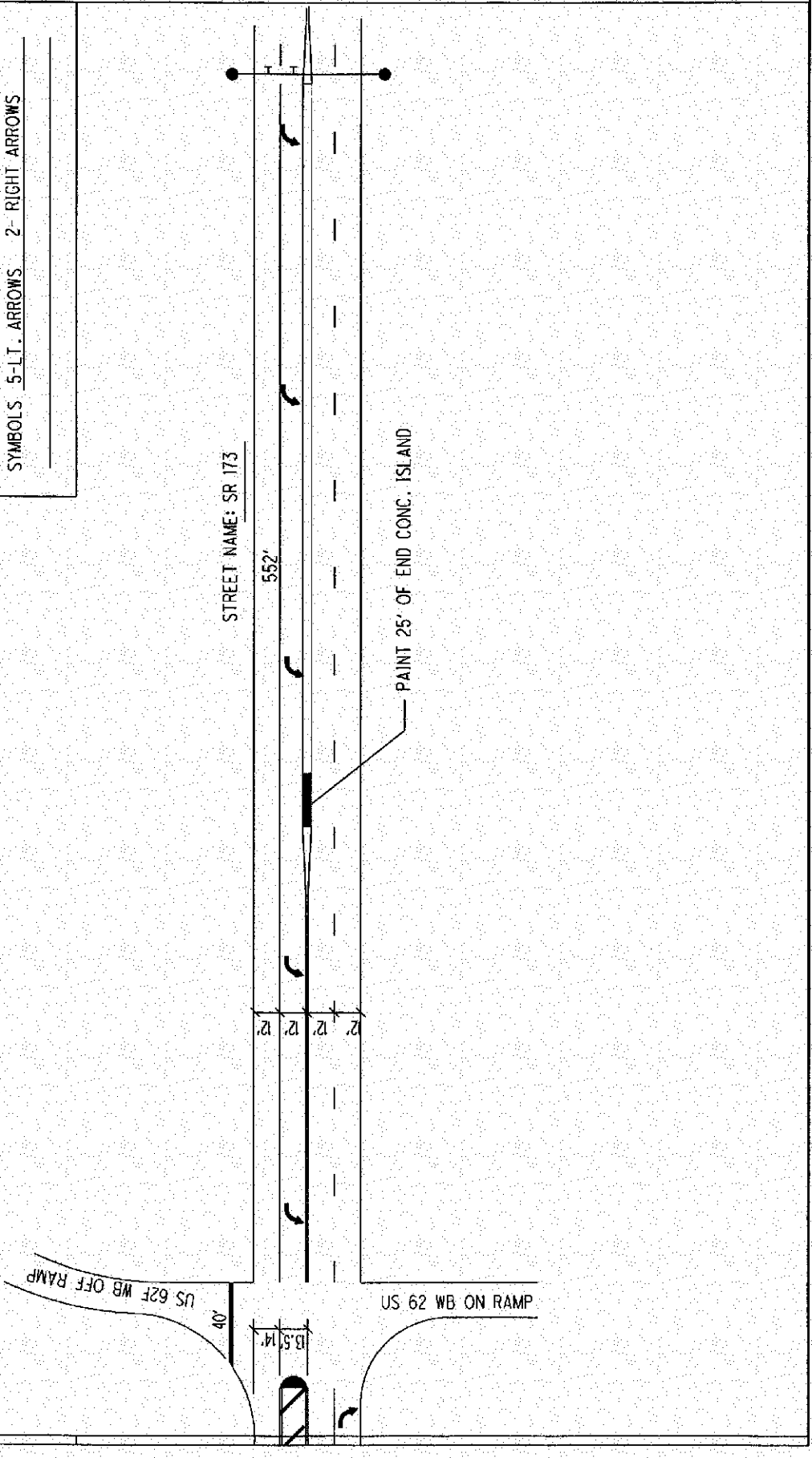

...|STA|173|SR173-4.49.DGN 12/14/2007 2:37:17 PM

I:\Projects\STA\25581_153_0747\structures\sheets\173_0315CGN001.dgn 08-FEB-2008 10:58AM ishevetz

STANDARD DRAWINGS AND SUPPLEMENTAL SPECIFICATIONS

REFER TO THE FOLLOWING STANDARD BRIDGE DRAWING(S):
AS-1-81 DATED/REVISED 7/19/02
AND TO THE FOLLOWING SUPPLEMENTAL SPECIFICATION(S):
843 DATED 4/18/03
848 DATED 4/15/05

DESIGN SPECIFICATIONS

DESIGN SPECIFICATIONS: THIS STRUCTURE CONFORMS TO "STANDARD SPECIFICATIONS FOR HIGHWAY BRIDGES" ADOPTED BY THE AMERICAN ASSOCIATION OF STATE HIGHWAY AND TRANSPORTATION OFFICIALS, 17TH EDITION, INCLUDING THE 2002 INTERIM SPECIFICATIONS AND THE ODOT BRIDGE DESIGN MANUAL.

DESIGN LOADING

STRUCTURE: STA-173-0425 - HS20-44 WITH ALTERNATE MILITARY LOADING

DECK PROTECTION METHOD

STRUCTURE STA-173-0425:
- MICRO SILICA MODIFIED CONCRETE OVERLAY

PROPOSED WORK

STRUCTURE: STA-173-0315
- NEW STRUCTURE IDENTIFICATION SIGNS

STRUCTURE: STA-173-0425
- REMOVE EXISTING CONCRETE OVERLAY AND REPLACE WITH NEW CONCRETE OVERLAY, WITH FULL DEPTH REPAIRS
- REPLACE COMPRESSION SEALS
- PATCH ALL UNSOUND AREAS OF SUBSTRUCTURE
- REPAIR EROSION AT FORWARD AND REAR RIGHT ABUTMENTS
- SEAL CONCRETE SURFACES (EPOXY-URETHANE) AT ABUTMENTS, WING WALLS, DECK EDGES, AND PIERS
- PLACE ROCK CHANNEL PROTECTION AT FORWARD RIGHT
- NEW STRUCTURE IDENTIFICATION AND OBJECT MARKER SIGNS

EXISTING STRUCTURE VERIFICATION

EXISTING STRUCTURE VERIFICATION: DETAILS AND DIMENSIONS SHOWN ON THESE PLANS PERTAINING TO THE EXISTING STRUCTURE HAVE BEEN OBTAINED FROM PLANS OF THE EXISTING STRUCTURE AND FROM FIELD OBSERVATIONS AND MEASUREMENTS. CONSEQUENTLY, THEY ARE INDICATIVE OF THE EXISTING STRUCTURE AND THE PROPOSED WORK BUT THEY SHALL BE CONSIDERED TENTATIVE AND APPROXIMATE. THE CONTRACTOR IS REFERRED TO CMS SECTIONS 102.05, 105.02 AND 513.04.

BASE CONTRACT BID PRICES UPON A RECOGNITION OF THE UNCERTAINTIES DESCRIBED ABOVE AND UPON A PREBID EXAMINATION OF THE EXISTING STRUCTURE. HOWEVER, THE DEPARTMENT WILL PAY FOR ALL PROJECT WORK BASED UPON ACTUAL DETAILS AND DIMENSIONS WHICH HAVE BEEN VERIFIED IN THE FIELD.

CONSTRUCTION AND DEMOLITION DEBRIS

THE CONTRACTOR SHALL TAKE PRECAUTIONS TO AVOID AND/OR LIMIT DEMOLITION DEBRIS FROM ENTERING THE STREAM. ANY MATERIAL THAT DOES FALL INTO THE STREAM SHALL BE REMOVED AS SOON AS POSSIBLE.

ITEM 601, ROCK CHANNEL PROTECTION, TYPE A WITH FABRIC FILTER, AS PER PLAN

THIS ITEM WILL BE PLACED AS DIRECTED BY THE ENGINEER TO PROTECT THE SUBSTRUCTURE AT THE FORWARD RIGHT OF STRUCTURE STA-173-0425. A QUANTITY IS GIVEN IN THE GENERAL SUMMARY FOR THIS WORK.

ITEM 601, DUMPED ROCK FILL, TYPE C

THIS ITEM WILL BE USED TO REPAIR THE EROSION OF THE SLOPE PROTECTION AT THE REAR RIGHT ABUTMENT WHERE THE FOOTER IS EXPOSED ON STRUCTURE STA-173-0425. A QUANTITY IS GIVEN IN THE GENERAL SUMMARY FOR THIS WORK.

ITEM 203, BORROW

THIS ITEM WILL BE USED TO REPAIR THE EROSION AT THE FORWARD RIGHT ABUTMENT OF STRUCTURE STA-173-0425. A QUANTITY IS GIVEN IN THE GENERAL SUMMARY FOR THIS WORK.

STREAM CHANNEL EXCAVATION

THE REMOVAL OF MATERIALS FROM BEECH CREEK SHALL BE LIMITED TO THE EXTENT NECESSARY TO RESTORE THE STREAM CHANNEL BACK TO THE ORIGINAL SPECIFICATIONS. ALL CLEANOUT WORK SHALL BE LIMITED TO AREA WITHIN THE EXISTING RIGHT-OF-WAY. THE CONTRACTOR SHALL TAKE ALL PRECAUTIONS NECESSARY TO PREVENT ANY INCIDENTAL DISCHARGES ASSOCIATED WITH THE EXCAVATION AND HAULING OF MATERIAL FROM THE STREAM CHANNEL. THIS PERTAINS TO ANY EXCAVATION OPERATION SUCH AS, FOUNDATION PIER OR ABUTMENT EXCAVATION, CHANNEL CLEAN OUT, EXCAVATION FOR ROCK CHANNEL PROTECTION AND REMOVAL OF ANY TEMPORARY FILL ASSOCIATED WITH CONSTRUCTION OPERATIONS.

ALL MATERIALS REMOVED MUST BE IMMEDIATELY REMOVED TO AN UPLAND SITE AND STABILIZED (I.E., SEED) TO PREVENT REDISTRIBUTION INTO ANY WATERS OF THE UNITED STATES. IMMEDIATE REMOVAL IS DEFINED BY THE UNITED STATES ARMY CORPS OF ENGINEERS AS DEPOSITING THE REMOVED MATERIALS DIRECTLY INTO A TRUCK AND REMOVING THE MATERIAL FROM THE SITE; PLACEMENT OF REMOVED MATERIALS INTO A WETLAND OR ON THE BANKS OF A STREAM EVEN TEMPORARILY IS CONSIDERED A FILL AND REQUIRES A PERMIT ACTION. ANY AREAS DISTURBED BY EQUIPMENT ACTIVITIES MUST BE SEED TO PREVENT EROSION OF SEDIMENTS INTO WATERS OF THE UNITED STATES.

ENDANGERED SPECIES HABITAT

THIS PROJECT IS WITHIN THE RANGE OF THE FEDERALLY ENDANGERED INDIANA BAT (MYOTIS SODALIS) AND MAY IMPACT SUMMER ROOSTING HABITAT FOR THIS SPECIES. THE SUMMER ROOSTING HABITAT FOR THE INDIANA BAT CONSISTS OF LIVING OR DEAD TREES OR SNAGS WITH EXFOLIATING, PEELING OR LOOSE BARK, SPLIT TRUNKS AND/OR BRANCHES OR CAVITIES. THEREFORE, ANY UNAVOIDABLE CUTTING OF SUCH TREES WILL BE PERFORMED ONLY AFTER SEPTEMBER 15 AND BEFORE APRIL 15.

BEST MANAGEMENT PRACTICES

WATER COLUMN AND SEDIMENTATION IMPACTS SHALL BE KEPT TO A MINIMUM THROUGH THE USE OF BEST MANAGEMENT PRACTICES FOR SOIL EROSION AND SEDIMENTATION CONTROL

OBJECT MARKERS AND STRUCTURE IDENTIFICATION SIGNS

OBJECT MARKERS WILL BE PLACED ON EACH APPROACH OFF THE LEFT AND RIGHT SHOULDER, FACING TRAFFIC, AND BEHIND THE GUARDRAIL IF APPLICABLE. ONE OM-3L AND ONE OM-3R WILL BE INSTALLED AT EACH APPROACH. THE SIGNS WILL BE MOUNTED ON NEW NO. 2 POSTS AND SHALL BE INSTALLED AS PER STANDARD CONSTRUCTION DRAWING TC-41.20, MOST CURRENT REVISION. EACH POST WILL BE 10.5 FT IN LENGTH.

STRUCTURE IDENTIFICATION SIGNS (I-H25a) WILL BE INSTALLED ON THE SAME POST AND DIRECTLY BELOW THE OBJECT MARKER OFF THE RIGHT SHOULDER ON EACH APPROACH. A QUANTITY OF ONE SIGN WILL BE INSTALLED AT EACH APPROACH. THE SIGNS WILL BE HAVE A NON-REFLECTIVE WHITE SHEETING BACKGROUND.

INSTALL SIGNS FOR THE FOLLOWING STRUCTURES:
STA-173-0425 (2 APPROACHES)

THE FOLLOWING QUANTITIES HAVE BEEN INCLUDED FOR EACH APPROACH:
ITEM 630 - SIGN, FLAT SHEET, 730.20, 1 SQ FT
ITEM 630 - SIGN, FLAT SHEET, 6 SQ FT
ITEM 630 - GROUND MOUNTED SUPPORT, NO. 2 POST, 21 FT

STRUCTURE IDENTIFICATION SIGNS

STRUCTURE IDENTIFICATION SIGNS (I-H25a) WILL BE PLACED ON EACH APPROACH OFF THE RIGHT SHOULDER, FACING TRAFFIC, AND BEHIND THE GUARDRAIL IF APPLICABLE. A QUANTITY OF ONE SIGN PER APPROACH WILL BE INSTALLED. THE SIGNS WILL BE HAVE A NON-REFLECTIVE WHITE SHEETING BACKGROUND.

THE SIGNS WILL BE MOUNTED ON NEW NO. 2 POSTS AND WILL BE INSTALLED AS PER STANDARD CONSTRUCTION DRAWING TC-41.20, MOST CURRENT REVISION. EACH POST WILL BE 7.5' IN LENGTH.

INSTALL SIGNS FOR THE FOLLOWING STRUCTURES:
STA-173-0315 (2 APPROACHES)

THE FOLLOWING QUANTITIES HAVE BEEN INCLUDED FOR EACH APPROACH:
ITEM 630 - SIGN, FLAT SHEET, 730.20, 1 SQ FT
ITEM 630 - GROUND MOUNTED SUPPORT, NO. 2 POST, 7.5 FT

PAINTING AND SEALING OPERATIONS

THE CONTRACTOR SHALL TAKE ALL PRECAUTIONS NECESSARY TO PREVENT EPOXY-URETHANE SEALER, PAINT, OR OTHER MATERIALS USED TO REPAIR, CLEAN, SEAL, OR TREAT ANY BRIDGE STRUCTURE FROM ENTERING ANY STREAMS, WETLANDS OR OTHER WATERS OF THE UNITED STATES AND TAKE THE APPROPRIATE ACTIONS IN THE EVENT OF A RELEASE.

CLEARING AND GRUBBING

ALTHOUGH THERE ARE NO TREES OR STUMPS SPECIFICALLY MARKED FOR REMOVAL WITHIN THE LIMITS OF THE PROJECT, A LUMP SUM QUANTITY IS INCLUDED IN THE GENERAL SUMMARY FOR ITEM 201, CLEARING AND GRUBBING. ALL PROVISIONS AS SET FORTH IN THE SPECIFICATIONS UNDER THIS ITEM ARE INCLUDED IN THE LUMP SUM PRICE BID FOR ITEM 201, CLEARING AND GRUBBING.

WATERWAY PERMIT DETERMINATION (404/401) - ODOT PROJECTS

ALL PROJECTS INVOLVING JURISDICTIONAL WATERS OF THE UNITED STATES (STREAMS, RIVERS, NON-ISOLATED WETLANDS) AND/OR ISOLATED WETLANDS ARE SUBJECT TO REGULATION UNDER SECTIONS 404 AND 401 OF THE CLEAN WATER ACT, AND POSSIBLY OHIO EPA ISOLATED WETLAND LAW. THE OHIO DEPARTMENT OF TRANSPORTATION - OFFICE OF ENVIRONMENTAL SERVICES (OES) AND/OR THE UNITED STATES ARMY CORPS OF ENGINEERS (USACE) HAS DETERMINED THAT THE PROJECT MEETS THE CRITERIA OF NATIONWIDE PERMIT (NWP) 3 - MAINTENANCE; BASED UPON THE ANTICIPATED IMPACTS TO STREAMS AND/OR WETLANDS. HOWEVER, THIS PERMIT DETERMINATION DID NOT INCLUDE THE USE OF TEMPORARY CONSTRUCTION ACCESS FILLS THAT MAY BE REQUIRED FOR CONSTRUCTION (I.E. CAUSEWAY STREAM CROSSINGS, CONSTRUCTION ACCESS PADS, COFFERDAMS, ETC.). INFORMATION REGARDING THE USE OF TEMPORARY CONSTRUCTION ACCESS FILLS MAY NOT HAVE BEEN KNOWN AT THE TIME OF THE PERMIT DETERMINATION. THE CONTRACTOR SHOULD BE AWARE THAT THE USE OF TEMPORARY FILL BELOW THE ORDINARY HIGH WATER MARK (OHWM), WHICH IS THE USACE'S JURISDICTIONAL LIMITS, WILL REQUIRE A PRE-CONSTRUCTION NOTIFICATION (PCN) AND AUTHORIZATION BY THE USACE UNDER NWP 33 - TEMPORARY CONSTRUCTION ACCESS AND DEWATERING. SHOULD TEMPORARY CONSTRUCTION ACCESS FILL BE REQUIRED, THE CONTRACTOR SHALL COORDINATE SUCH ACTIVITIES, INCLUDING THE PCN, THROUGH OES AND ALLOW 60 DAYS MINIMUM FOR PROCESSING WITH THE USACE. THE CONTRACTOR SHALL NOT COORDINATE THESE ACTIVITIES DIRECTLY WITH THE USACE. THE CONTRACTOR SHALL NOT UTILIZE TEMPORARY FILLS BELOW OHWM UNTIL SUCH ACTIVITY IS AUTHORIZED BY THE USACE. SHOULD A PCN BE REQUIRED, THE PCN SHALL INCLUDE PERTINENT INFORMATION (I.E. VOLUME AND SURFACE AREA OF TEMPORARY FILLS) AND DRAWINGS (PLAN AND PROFILE VIEW) OF TEMPORARY FILLS BELOW OHWM. ONLY CLEAN, NON ERODIBLE MATERIALS SHALL BE USED FOR TEMPORARY CONSTRUCTION ACCESS FILLS. ANY TEMPORARY FILLS BELOW OHWM SHALL BE REMOVED FOLLOWING COMPLETION OF THE AUTHORIZED ACTIVITY AND THE AREA OF STREAM WHERE TEMPORARY FILL WAS LOCATED SHALL BE RESTORED TO ITS PRE-CONSTRUCTION CONDITION.

USACE DEFINITION OF OHWM - THE ORDINARY HIGH WATER MARK IS THE LINE ON THE SHORES ESTABLISHED BY THE FLUCTUATIONS OF WATER AND INDICATED BY PHYSICAL CHARACTERISTICS SUCH AS A CLEAR, NATURAL LINE IMPRESSED ON THE BANK; SHELVEING; CHANGES IN THE CHARACTER OF THE SOIL; DESTRUCTION OF TERRESTRIAL VEGETATION; THE PRESENCE OF LITTER AND DEBRIS; OR THE APPROPRIATE MEANS THAT CONSIDER THE CHARACTERISTICS OF THE SURROUNDING AREAS.

MECHANICAL EQUIPMENT OPERATION AT STREAM CHANNEL

THE MECHANICAL EQUIPMENT USED TO EXECUTE THE WORK AUTHORIZED HEREIN SHALL BE OPERATED IN SUCH A WAY AS TO MINIMIZE TURBIDITY THAT COULD DEGRADE WATER QUALITY AND ADVERSELY AFFECT AQUATIC PLANT AND ANIMAL LIFE.

TEMPORARY SOIL EROSION AND SEDIMENT CONTROL MEASURES

ALL SOIL EROSION AND SEDIMENT CONTROL PRACTICES SHALL BE IN PLACE PRIOR TO ANY CONSTRUCTION OPERATIONS AND INSTALLATION OF PROPOSED STRUCTURES OR UTILITIES. THEY SHALL REMAIN IN PLACE UNTIL CONSTRUCTION IS COMPLETE AND THE AREA IS STABILIZED AS ACCEPTED BY THE ENGINEER.

DESIGN AGENCY ODOT --- DISTRICT 4 PRODUCTION	
DATE 01-02-08	STRUCTURE FILE NUMBER 7605498 & 7605536
REVIEWED TJP	DRAWN LMS
DESIGNED LMS	CHECKED
STRUCTURE NOTES	
STA-173-0315 AND STA-173-0425 BRANCH OF BEECH CREEK AND BEECH CREEK	
STA-153/173- 7.81/0.00 PID No. 25581	
1 / 4	
20 23	

CALC: LMS DATE: 12/5/2007
 CHECKED: TJP DATE: 1/2/2008

ESTIMATED QUANTITIES

BRIDGE NO. / STRUCTURE FILE NO.						ITEM	EXTENSION	UNIT	DESCRIPTION	SEE SHEET
STA-173-0315 SFN 7605498				STA-173-0425 SFN 7605536						
				LUMP	201	11000		CLEARING AND GRUBBING		
				10	203	40000	CU YD	BORROW		
				359	512	10100	SQ YD	SEALING OF CONCRETE SURFACES (EPOXY-URETHANE)		
				80	516	10000	FT	PREFORMED ELASTOMERIC COMPRESSION JOINT SEAL		
				10	601	27000	CU YD	DUMPED ROCK FILL, TYPE C		
				30	601	32005	CU YD	ROCK CHANNEL PROTECTION, TYPE A WITH FABRIC FILTER, AS PER PLAN	1/4	
15				42	630	02100	FT	GROUND MOUNTED SUPPORT, NO. 2 POST		
				12	630	80100	SQ FT	SIGN, FLAT SHEET		
2				2	630	80100	SQ FT	SIGN, FLAT SHEET, 730.20		
				90	843	50000	SQ FT	PATCHING CONCRETE STRUCTURES WITH TROWELABLE MORTAR		
				568	848	10000	SQ YD	MICRO SILICA MODIFIED CONCRETE OVERLAY USING HYDRODEMOLITION (T=1")		
				568	848	20000	SQ YD	SURFACE PREPARATION USING HYDRODEMOLITION		
				19	848	30000	CU YD	MICRO SILICA MODIFIED CONCRETE OVERLAY (VARIABLE THICKNESS), MATERIAL ONLY		
				2	848	50000	SQ YD	HAND CHIPPING		
				LUMP	848	50100		TEST SLAB		
				1	848	50200	CU YD	FULL-DEPTH REPAIR		

DESIGN AGENCY
 ODOT --- DISTRICT 4
 PRODUCTION

DESIGNED
 LMS
 CHECKED

DRAWN
 LMS
 REVISED

REVIEWED
 TJP
 STRUCTURE FILE NUMBER
 7605498 & 7605536

DATE
 01-02-08

ESTIMATED QUANTITIES
 STA-173-0315 AND STA-173-0425
 BRANCH OF BEECH CREEK AND BEECH CREEK

STA-153/173-
7.81/0.00
PID No. 25581

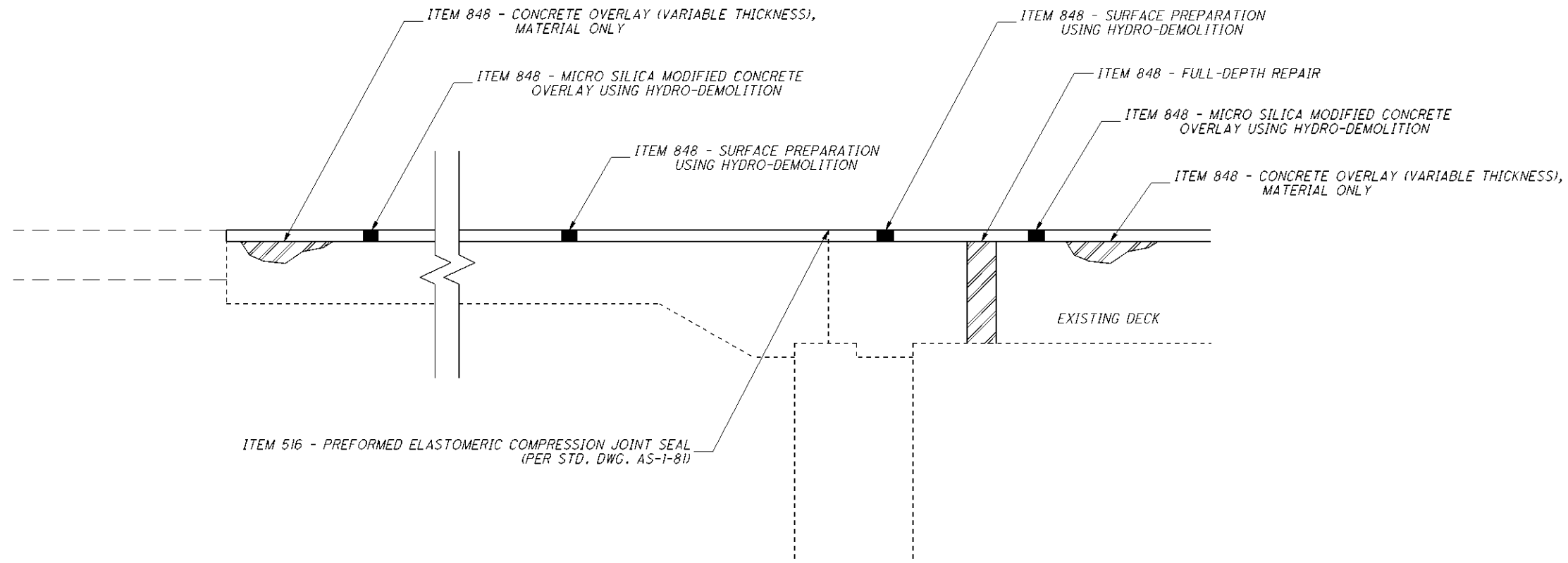

STA-173-0425
 APPROACH PAVEMENT SHOWN,
 TRAILING PAVEMENT SIMILAR

BRIDGE NUMBER	BRIDGE DECK										APPROACH SLABS							
	LENGTH (BRIDGE LIMITS)	WIDTH (CURB / CURB)	DECK AREA	848	848	848	848	848	516	LENGTH	WIDTH	AREA	APPROACH (FORWARD / REAR)	848	848	848	848	
	FT	FT	SQ YD	MICRO SILICA MODIFIED CONCRETE OVERLAY USING HYDRO-DEMOLITION, 1" THICK	SURFACE PREPARATION USING HYDRO-DEMOLITION	CONCRETE OVERLAY (VARIABLE THICKNESS), MATERIAL ONLY	HAND CHIPPING	FULL-DEPTH REPAIR	PREFORMED ELASTOMERIC COMPRESSION JOINT SEAL	FT	FT	SQ YD		MICRO SILICA MODIFIED CONCRETE OVERLAY USING HYDRO-DEMOLITION, 1" THICK	SURFACE PREPARATION USING HYDRO-DEMOLITION	CONCRETE OVERLAY (VARIABLE THICKNESS), MATERIAL ONLY	HAND CHIPPING	
			SQ YD	SQ YD	SQ YD	CU YD	SQ YD	CU YD	FT	FT	FT		SQ YD	SQ YD	CU YD	SQ YD		
STA-173-0425	82.76	40	367.82	367.82	367.82	12.26	1.23	1.00	80	20	40	88.89	REAR	88.89	88.89	2.96	0.30	
										25	40	111.11	FWD	111.11	111.11	3.70	0.37	

STRUCTURE NOTES
 STA-173-0425
 BEECH CREEK

STA-153/173-7.81/0.00
 PID No. 25581

3 / 4

22
23

DESIGNED LMS CHECKED	DRAWN LMS REVISED	REVIEWED TJP	DATE 01-02-08	DESIGN AGENCY ODOT --- DISTRICT 4
			STRUCTURE FILE NUMBER 7605536	PRODUCTION

I:\Projects\STA\25581_153_074\25581\structures\sheets\173_0425CMD001.dgn 08-FEB-2008 10:22AM rbaughma

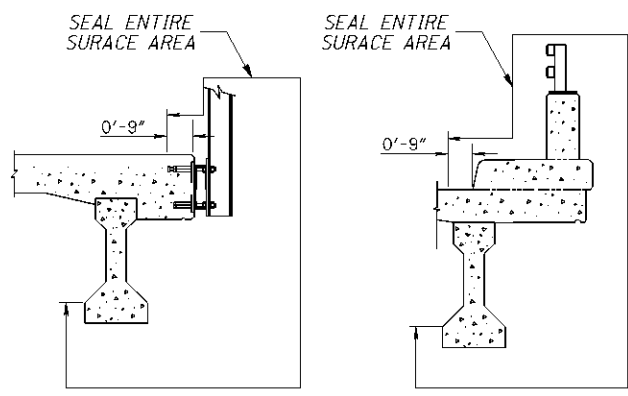

DETAIL A
CONCRETE DECKS WITH
OVER THE SIDE DRAINAGE

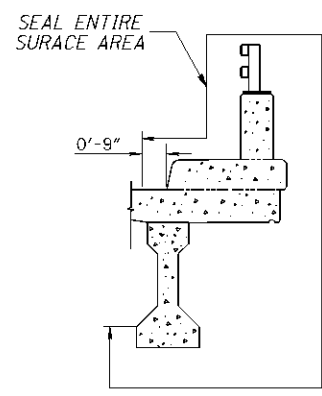

DETAIL B
CONCRETE DECKS WITH CURBS,
SIDEWALKS AND PARAPET

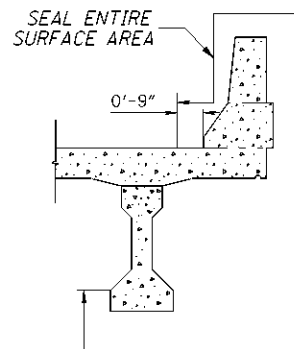

DETAIL C
CONCRETE DECK WITH
DEFLECTOR PARAPET

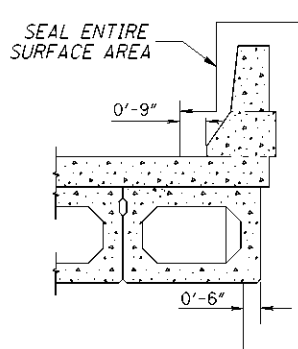

DETAIL D
PRESTRESSED BOX BEAM DECK
WITH DEFLECTOR PARAPET

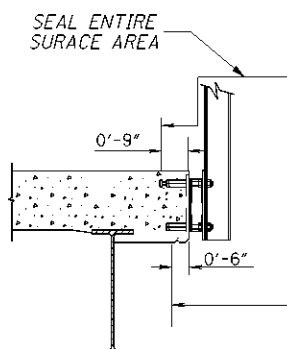

DETAIL E
CONCRETE DECKS WITH
OVER THE SIDE DRAINAGE

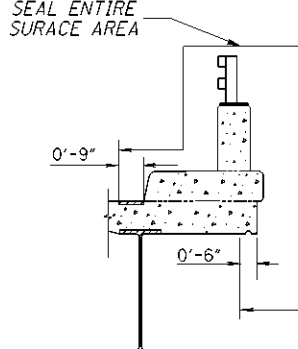

DETAIL F
CONCRETE DECKS WITH CURBS,
SIDEWALKS AND PARAPET

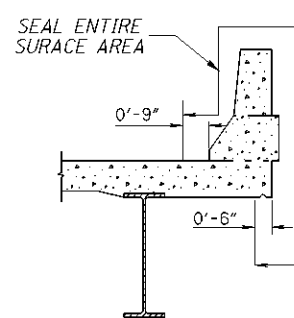

DETAIL G
CONCRETE DECK WITH
DEFLECTOR PARAPET

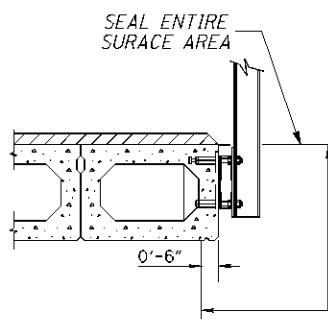

DETAIL H
PRESTRESSED BOX BEAM DECK
WITH OVER THE SIDE DRAINAGE

BRIDGE NO.	STRUCTURE TYPE	PROPOSED SEALING	FEDERAL COLOR NUMBER	ESTIMATED QUANTITIES				
				ABUT SQ YD	PIER SQ YD	SUPER SQ YD	GEN SQ YD	TOTAL SQ YD
STA-173-0425	2 SPAN CONTINUOUS CONCRETE SLAB	SEAL DECK EDGES PER DETAIL H SEAL ALL EXPOSED CONCRETE AT ABUTMENTS SEAL ALL EXPOSED CONCRETE AT PIERS	PER CMS	237	82	40		359

NOTES:
 - EPOXY-URETHANE SEALER SHALL BE USED UNLESS SHOWN OTHERWISE
 - DETAILS E, F, G AND H ALSO APPLY TO CONCRETE SLAB BRIDGES

SEALING OF BEAM SEATS
 SEALING OF BEAM SEATS: IF THE BEAMS SEATS ARE SEALED WITH AN EPOXY OR NON-EPOXY SEALER PRIOR TO SETTING THE BEARINGS, DO NOT APPLY SEALER TO THE CONCRETE SURFACES UNDER THE PROPOSED BEARING LOCATIONS. IF THESE LOCATIONS ARE SEALED, REMOVE THE SEALER TO THE SATISFACTION OF THE ENGINEER PRIOR TO SETTING THE BEARINGS. THE DEPARTMENT WILL NOT PAY FOR THIS REMOVAL.

DESIGN AGENCY ODOT --- DISTRICT 4	
DATE 01-02-08	REVISION TJP
STRUCTURE FILE NUMBER 7605536	DRAWN LMS
DESIGNED LMS	CHECKED
CONCRETE SEALING DETAILS STA-173-0425 BEECH CREEK	
STA-153/173-7.81/0.00	PID No. 25581
4 / 4	23 / 23