

DESIGN DESIGNATION	I.R. 76 / I.R. 77	RAMP L	RAMP M	RAMP N	RAMP P	RAMP T	RAMP U	RAMP W
CURRENT ADT (2020)	101,350	3,660	4,200	4,540	3,930	16,620	18,280	16,100
DESIGN YEAR ADT (2040)	95,820	3,720	4,360	4,490	3,930	29,360	18,680	18,190
DESIGN HOURLY VOLUME AM/PM (2040)	10,080 / 9,650	190 / 270	370 / 380	410 / 130	310 / 270	1,900 / 2,930	1,740 / 1,240	2,390 / 1,790
DIRECTIONAL DISTRIBUTION	59%	N/A	N/A	N/A	N/A	N/A	N/A	N/A
TRUCKS (24 HOUR B&C)	13%	3%	5%	4%	4%	4%	18%	7%
DESIGN SPEED	60	50	50	50	50	50	50	50
LEGAL SPEED	55	N/A	N/A	N/A	N/A	N/A	N/A	N/A
DESIGN FUNCTIONAL CLASSIFICATION	URBAN INTERSTATE	URBAN RAMP	URBAN RAMP	URBAN RAMP	URBAN RAMP	URBAN RAMP	URBAN RAMP	URBAN RAMP

DESIGN DESIGNATION	RAMP V	RAMP G	RAMP J	RAMP L	RAMP EN	RAMP SW	RAMP W10	RAMP W11
CURRENT ADT (2020)	17,350	1,670	6,690	7,330	11,560	14,020	3,350	4,930
DESIGN YEAR ADT (2040)	26,510	1,760	6,690	7,330	12,230	14,940	3,440	5,170
DESIGN HOURLY VOLUME AM/PM (2040)	1,410 / 1,680	130 / 210	850 / 1,010	820 / 570	1,730 / 900	990 / 1,810	570 / 410	290 / 560
DIRECTIONAL DISTRIBUTION	N/A	N/A	N/A	N/A	N/A	N/A	N/A	N/A
TRUCKS (24 HOUR B&C)	18%	7%	1%	2%	3%	4%	3%	4%
DESIGN SPEED	50	45	45	45	50	50	45	45
LEGAL SPEED	N/A	N/A	N/A	N/A	N/A	N/A	N/A	N/A
DESIGN FUNCTIONAL CLASSIFICATION	URBAN RAMP	URBAN RAMP	URBAN RAMP	URBAN RAMP	URBAN RAMP	URBAN RAMP	URBAN RAMP	URBAN RAMP

DESIGN DESIGNATION	I.R. 77 / S.R. 8	RAMP S12	RAMP S11	RAMP S10	RAMP S9	RAMP S8	RAMP S7	RAMP S6
CURRENT ADT (2020)	129,870	4,270	4,490	5,290	3,980	4,320	5,010	5,450
DESIGN YEAR ADT (2040)	136,410	4,270	4,490	5,290	3,980	4,790	5,340	5,490
DESIGN HOURLY VOLUME AM/PM (2040)	12,580 / 13,240	340 / 380	400 / 480	420 / 670	270 / 430	310 / 370	520 / 460	410 / 380
DIRECTIONAL DISTRIBUTION	52%	N/A	N/A	N/A	N/A	N/A	N/A	N/A
TRUCKS (24 HOUR B&C)	7%	3%	4%	3%	3%	5%	4%	3%
DESIGN SPEED	60	45	45	45	45	45	45	45
LEGAL SPEED	55	N/A	N/A	N/A	N/A	N/A	N/A	N/A
DESIGN FUNCTIONAL CLASSIFICATION	URBAN INTERSTATE	URBAN RAMP	URBAN RAMP	URBAN RAMP	URBAN RAMP	URBAN RAMP	URBAN RAMP	URBAN RAMP

DESIGN DESIGNATION	RAMP S5	RAMP T / RAMP O	RAMP N / RAMP M	RAMP U	RAMP S / RAMP P	RAMP S2	RAMP R
CURRENT ADT (2020)	6,840	30,290	27,100	24,280	21,660	10,260	10,400
DESIGN YEAR ADT (2040)	6,980	31,840	28,530	25,280	22,550	10,930	11,390
DESIGN HOURLY VOLUME AM/PM (2040)	780 / 540	3,560 / 2,750	2,170 / 2,860	2,750 / 2,330	2,120 / 1,840	1,430 / 750	560 / 1,140
DIRECTIONAL DISTRIBUTION	N/A	N/A	N/A	N/A	N/A	N/A	N/A
TRUCKS (24 HOUR B&C)	3%	9%	9%	5%	5%	4%	3%
DESIGN SPEED	45	45	45	45	45	45	45
LEGAL SPEED	N/A	N/A	N/A	N/A	N/A	N/A	N/A
DESIGN FUNCTIONAL CLASSIFICATION	URBAN RAMP	URBAN RAMP	URBAN RAMP	URBAN RAMP	URBAN RAMP	URBAN RAMP	URBAN RAMP

CALCULATED
MLL
CHECKED
JTW

DESIGN DESIGNATIONS

SUM-76 / 77 / 8-
8.24 / 9.74 / 0.00

P:\02329_SUM-76_77\Design\Roadway\Sheets\02329_G002.dgn Sheet 8/7/2020 11:28:42 AM mlute



50
100
200
HORIZONTAL
SCALE IN FEET

CALCULATED
M.L.L.
CHECKED
J.T.W.

SUM-76 / 77 / 8 -
SCHEMATIC PLAN - I.R. 77
END I.R. 77 PROJECT TO STA. 211+00

8.24 / 9.74 / 0.00

3
138

CURVE 1 - I.R. 77
 P.I. Sta. 212+28.23
 $\Delta = 84^\circ 18' 18''$ (LT)
 $Dc = 2^\circ 00' 00''$
 $R = 2,864.79'$
 $T = 2,593.31'$
 $L = 4,215.25'$
 $E = 999.44'$
 $C = 3,845.16'$
 C.B. = S 45° 12' 47" E

CURVE 2 - RAMP M
 P.I. Sta. 2+75.82
 $\Delta = 81^\circ 58' 54''$ (RT)
 $Dc = 28^\circ 38' 52''$
 $R = 200.00'$
 $T = 173.80'$
 $L = 286.17'$
 $E = 64.97'$
 $C = 262.38'$
 C.B. = N 68° 27' 36" W

CURVE 3 - RAMP M
 P.I. Sta. 7+50.25
 $\Delta = 5^\circ 16' 57''$ (RT)
 $Dc = 4^\circ 00' 00''$
 $R = 1,432.39'$
 $T = 66.08'$
 $L = 132.06'$
 $E = 1.52'$
 $C = 132.01'$
 C.B. = N 3° 20' 31" W

CURVE 4 - RAMP N
 P.I. Sta. 1+83.82
 $\Delta = 14^\circ 37' 34''$ (RT)
 $Dc = 4^\circ 00' 00''$
 $R = 1,432.39'$
 $T = 183.82'$
 $L = 365.65'$
 $E = 11.75'$
 $C = 364.66'$
 C.B. = N 19° 29' 38" W

CURVE 5 - RAMP N
 P.I. Sta. 5+15.20
 $\Delta = 20^\circ 42' 32''$ (RT)
 $Dc = 7^\circ 00' 00''$
 $R = 818.51'$
 $T = 149.55'$
 $L = 295.84'$
 $E = 13.55'$
 $C = 294.23'$
 C.B. = N 1° 49' 36" W

CURVE 6 - RAMP N
 P.I. Sta. 8+73.58
 $\Delta = 34^\circ 29' 42''$ (RT)
 $Dc = 28^\circ 38' 52''$
 $R = 200.00'$
 $T = 62.09'$
 $L = 120.41'$
 $E = 9.42'$
 $C = 118.60'$
 C.B. = N 52° 30' 40" E

CURVE 7 - RAMP L
 P.I. Sta. 7+79.91
 $\Delta = 13^\circ 52' 19''$ (RT)
 $Dc = 20^\circ 00' 00''$
 $R = 286.48'$
 $T = 34.85'$
 $L = 69.36'$
 $E = 2.11'$
 $C = 69.19'$
 C.B. = S 21° 54' 04" W

CURVE 8 - RAMP L
 P.I. Sta. 13+89.24
 $\Delta = 53^\circ 17' 14''$ (LT)
 $Dc = 20^\circ 06' 14''$
 $R = 285.00'$
 $T = 142.99'$
 $L = 265.00'$
 $E = 33.86'$
 $C = 255.61'$
 C.B. = S 2° 51' 58" W

CURVE 9 - RAMP P
 P.I. Sta. 1+08.78
 $\Delta = 47^\circ 01' 42''$ (RT)
 $Dc = 22^\circ 55' 06''$
 $R = 250.00'$
 $T = 108.78'$
 $L = 205.20'$
 $E = 22.64'$
 $C = 199.49'$
 C.B. = N 85° 49' 14" W

SPIRAL 1 - I.R. 77
 P.I. STA. 185+34.95
 $Ls = 300.00'$
 $\theta s = 3^\circ 00' 00''$
 $LT = 200.03'$
 $ST = 100.03'$
 $x = 299.92'$
 $y = 5.23'$
 $k = 149.99'$
 $p = 1.31'$

SPIRAL 2 - RAMP M
 P.I. STA. 4+38.87
 $Ls = 150.00'$
 $\theta s = 21^\circ 29' 09''$
 $LT = 100.75'$
 $ST = 50.68'$
 $x = 147.90'$
 $y = 18.56'$
 $k = 74.65'$
 $p = 4.66'$

SPIRAL 3 - RAMP N
 P.I. STA. 7+53.01
 $Ls = 150.00'$
 $\theta s = 26^\circ 44' 09''$
 $LT = 91.52'$
 $ST = 61.06'$
 $x = 146.05'$
 $y = 27.47'$
 $k = 74.46'$
 $p = 3.53'$

SPIRAL 4 - RAMP L
 P.I. STA. 6+95.42
 $Ls = 150.00'$
 $\theta s = 15^\circ 00' 00''$
 $LT = 100.36'$
 $ST = 50.33'$
 $x = 148.98'$
 $y = 13.03'$
 $k = 74.83'$
 $p = 3.26'$

SPIRAL 5 - RAMP L
 P.I. STA. 8+64.75
 $Ls = 150.00'$
 $\theta s = 15^\circ 00' 00''$
 $LT = 100.36'$
 $ST = 50.33'$
 $x = 148.98'$
 $y = 13.03'$
 $k = 74.83'$
 $p = 3.26'$

SPIRAL 6 - RAMP L
 P.I. STA. 11+96.62
 $Ls = 150.00'$
 $\theta s = 15^\circ 04' 40''$
 $LT = 100.37'$
 $ST = 50.33'$
 $x = 148.96'$
 $y = 13.09'$
 $k = 74.83'$
 $p = 3.28'$

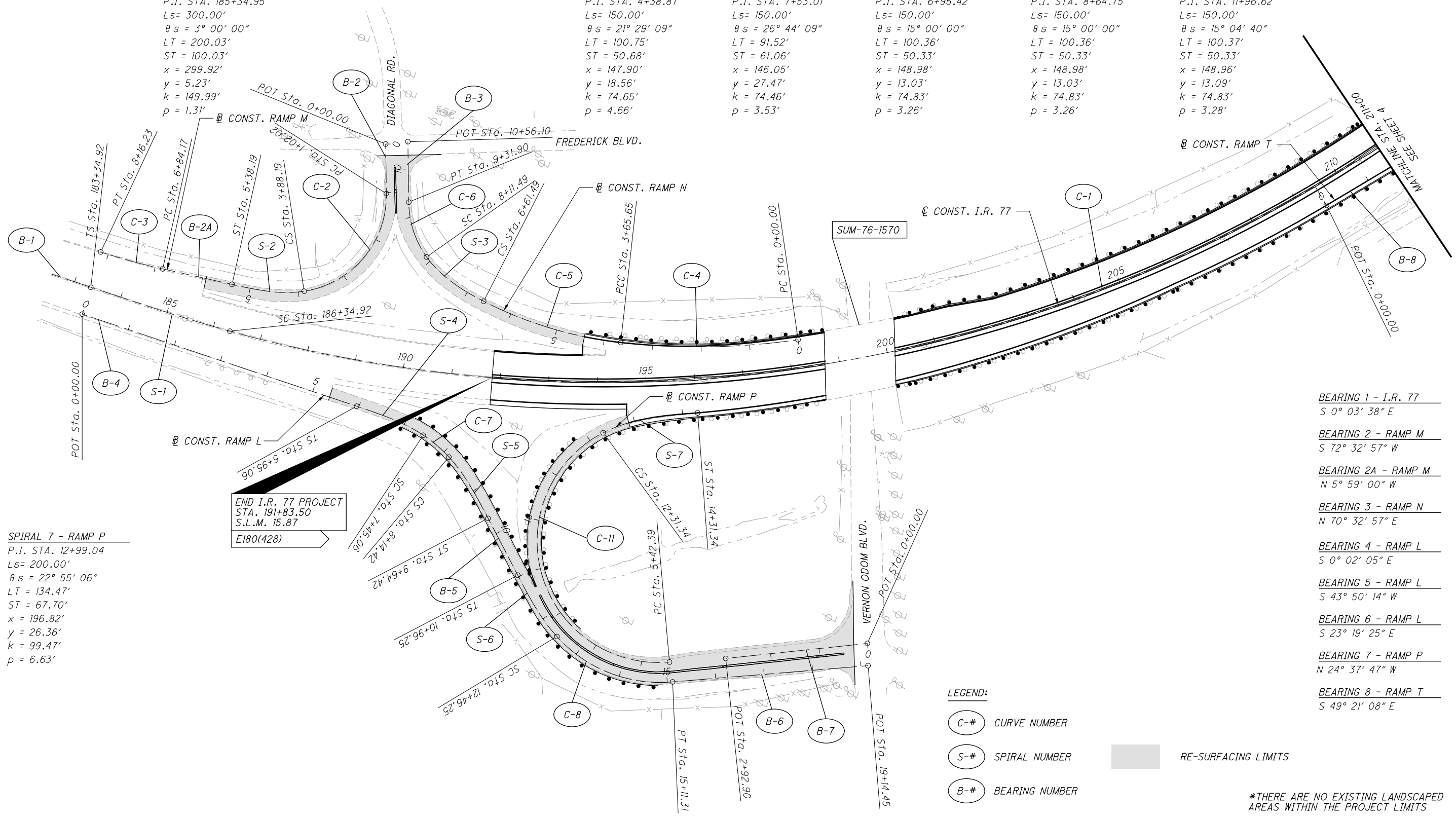

SPIRAL 7 - RAMP P
 P.I. STA. 12+99.04
 $Ls = 200.00'$
 $\theta s = 22^\circ 55' 06''$
 $LT = 134.47'$
 $ST = 67.70'$
 $x = 196.82'$
 $y = 26.36'$
 $k = 99.47'$
 $p = 6.63'$

- BEARING 1 - I.R. 77
S 0° 03' 38" E
- BEARING 2 - RAMP M
S 72° 32' 57" W
- BEARING 2A - RAMP M
N 5° 59' 00" W
- BEARING 3 - RAMP N
N 70° 32' 57" E
- BEARING 4 - RAMP L
S 0° 02' 05" E
- BEARING 5 - RAMP L
S 43° 50' 14" W
- BEARING 6 - RAMP L
S 23° 19' 25" E
- BEARING 7 - RAMP P
N 24° 37' 47" W
- BEARING 8 - RAMP T
S 49° 21' 08" E

LEGEND:

- C-# CURVE NUMBER
- S-# SPIRAL NUMBER
- B-# BEARING NUMBER

RE-SURFACING LIMITS

*THERE ARE NO EXISTING LANDSCAPED AREAS WITHIN THE PROJECT LIMITS

P:\102329_SUM-76_77\Design\Roadway\Sheets\102329_GB001.dgn Sheet 8/7/2020 11:28:49 AM mlufes

CURVE 12 - RAMP T
P.I. Sta. 8+37.40
 $\Delta = 36^\circ 38' 39''$ (RT)
Dc = 4° 01' 22"
R = 1,424.26'
T = 471.64'
L = 910.90'
E = 76.06'
C = 895.46'
C.B. = S 31° 01' 48" E

CURVE 15 - RAMP V
P.I. Sta. 15+69.19
 $\Delta = 6^\circ 08' 47''$ (LT)
Dc = 10° 21' 48"
R = 552.87'
T = 29.68'
L = 59.31'
E = 0.80'
C = 59.28'
C.B. = N 73° 12' 15" W

CURVE 16 - RAMP W
P.I. Sta. 12+29.90
 $\Delta = 157^\circ 05' 59''$ (RT)
Dc = 23° 00' 00"
R = 249.11'
T = 1,229.90'
L = 683.04'
E = 1,005.76'
C = 488.31'
C.B. = S 2° 16' 21" W

CURVE 17 - I.R. 76
P.I. Sta. 101+64.65
 $\Delta = 97^\circ 10' 50''$ (RT)
Dc = 11° 00' 00"
R = 520.87'
T = 590.61'
L = 883.46'
E = 266.61'
C = 781.31'
C.B. = N 55° 07' 56" E

CURVE 1 - I.R. 77
P.I. Sta. 212+28.23
 $\Delta = 84^\circ 18' 18''$ (LT)
Dc = 2° 00' 00"
R = 2,864.79'
T = 2,593.31'
L = 4,215.25'
E = 999.44'
C = 3,845.16'
C.B. = S 45° 12' 47" E

SPIRAL 15 - I.R. 76
P.I. STA. 94+58.77
Ls = 350.00'
 $\theta s = 19^\circ 15' 00''$
LT = 234.73'
ST = 117.94'
x = 346.07'
y = 38.88'
k = 174.34'
p = 9.76'

SPIRAL 8 - I.R. 76
P.I. STA. 229+50.20
Ls = 300.00'
 $\theta s = 3^\circ 00' 00''$
LT = 200.03'
ST = 100.03'
x = 299.92'
y = 5.23'
k = 149.99'
p = 1.31'

SPIRAL 9 - RAMP U
P.I. STA. 7+35.45
Ls = 350.00'
 $\theta s = 19^\circ 15' 00''$
LT = 234.73'
ST = 117.94'
x = 346.07'
y = 38.88'
k = 174.34'
p = 9.76'

SPIRAL 10 - RAMP U
P.I. STA. 15+76.32
Ls = 350.00'
 $\theta s = 19^\circ 15' 00''$
LT = 234.73'
ST = 117.94'
x = 346.07'
y = 38.88'
k = 174.34'
p = 9.76'

SPIRAL 11 - RAMP V
P.I. STA. 2+67.28
Ls = 400.00'
 $\theta s = 12^\circ 00' 00''$
LT = 267.28'
ST = 133.89'
x = 398.25'
y = 27.84'
k = 199.71'
p = 6.97'

SPIRAL 12 - RAMP V
P.I. STA. 7+73.40
Ls = 400.00'
 $\theta s = 12^\circ 00' 00''$
LT = 267.28'
ST = 133.89'
x = 398.25'
y = 27.84'
k = 199.71'
p = 6.97'

SPIRAL 13 - RAMP V
P.I. STA. 14+24.08
Ls = 350.00'
 $\theta s = 18^\circ 08' 09''$
LT = 234.57'
ST = 117.79'
x = 346.51'
y = 36.67'
k = 174.42'
p = 9.20'

SPIRAL 14 - RAMP W
P.I. STA. 7+56.45
Ls = 200.00'
 $\theta s = 25^\circ 01' 57''$
LT = 129.38'
ST = 73.41'
x = 195.89'
y = 31.06'
k = 99.37'
p = 6.07'

CURVE 13 - RAMP U
P.I. Sta. 11+94.45
 $\Delta = 66^\circ 50' 33''$ (RT)
Dc = 25° 00' 00"
R = 520.87'
T = 343.73'
L = 607.66'
E = 103.19'
C = 573.78'
C.B. = N 39° 57' 48" E

CURVE 14 - RAMP V
P.I. Sta. 5+20.39
 $\Delta = 14^\circ 22' 14''$ (RT)
Dc = 6° 00' 00"
R = 954.93'
T = 120.39'
L = 239.51'
E = 7.56'
C = 238.88'
C.B. = N 71° 10' 49" W

BEARING 8 - RAMP T
S 49° 21' 08" E

BEARING 9 - I.R. 76
N 89° 38' 4" E

BEARING 10 - RAMP U
S 87° 21' 55" E

BEARING 11 - RAMP V
S 51° 59' 42" W

BEARING 12 - I.R. 76
N 12° 42' 29" W

LEGEND:

- (C-#) CURVE NUMBER
- (S-#) SPIRAL NUMBER
- (B-#) BEARING NUMBER

RE-SURFACING LIMITS

*THERE ARE NO EXISTING LANDSCAPED AREAS WITHIN THE PROJECT LIMITS

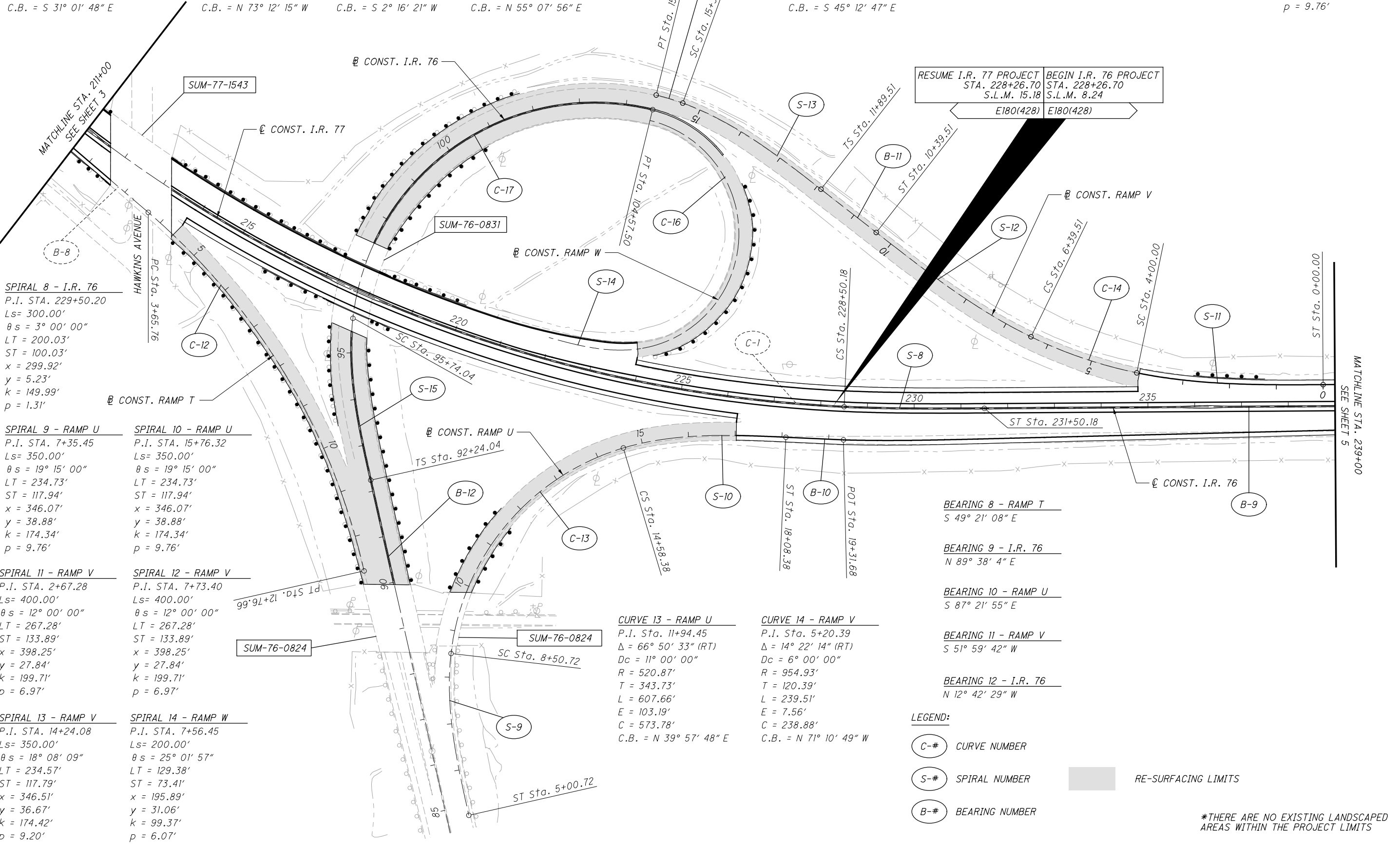

CURVE 18 - I.R. 76 P.I. Sta. 252+01.26 $\Delta = 17^\circ 36' 26''$ (LT) Dc = 1° 15' 03" R = 4,581.00' T = 709.47' L = 1,407.76' E = 54.61' C = 1,402.23' C.B. = N 80° 49' 50" E	CURVE 19 - RAMP L P.I. Sta. 1+07.18 $\Delta = 30^\circ 00' 00''$ (RT) Dc = 14° 19' 26" R = 400.00' T = 107.18' L = 209.44' E = 14.11' C = 207.06' C.B. = N 50° 48' 38" E	CURVE 20 - RAMP L P.I. Sta. 6+33.27 $\Delta = 8^\circ 45' 55''$ (RT) Dc = 2° 30' 00" R = 2,291.83' T = 175.65' L = 350.61' E = 6.72' C = 350.27' C.B. = N 70° 08' 25" E	CURVE 21 - RAMP K P.I. Sta. 1+00.10 $\Delta = 55^\circ 56' 16''$ (LT) Dc = 57° 17' 45" R = 100.00' T = 53.10' L = 97.63' E = 13.22' C = 93.80' C.B. = S 82° 36' 19" E	CURVE 22 - RAMP J P.I. Sta. 0+92.17 $\Delta = 14^\circ 53' 15''$ (RT) Dc = 8° 07' 19" R = 705.44' T = 92.17' L = 183.30' E = 6.00' C = 182.78' C.B. = N 85° 00' 17" W	CURVE 23 - RAMP J P.I. Sta. 4+74.90 $\Delta = 86^\circ 41' 58''$ (RT) Dc = 38° 11' 50" R = 150.00' T = 141.60' L = 226.98' E = 56.28' C = 205.93' C.B. = N 1° 41' 38" W	CURVE 24 - RAMP J P.I. Sta. 7+77.93 $\Delta = 71^\circ 55' 24''$ (RT) Dc = 19° 05' 55" R = 300.00' T = 217.66' L = 376.59' E = 70.64' C = 352.35' C.B. = N 76° 02' 51" E	CURVE 25 - RAMP J P.I. Sta. 10+52.84 $\Delta = 75^\circ 24' 59''$ (RT) Dc = 38° 11' 50" R = 150.00' T = 115.97' L = 197.44' E = 39.60' C = 183.49' C.B. = S 30° 27' 51" E
--	--	---	---	---	---	--	---

SPIRAL 16 - RAMP J P.I. STA. 2+75.07 Ls = 150.00' $\theta s = 30^\circ 30' 26''$ LT = 91.77' ST = 61.62' x = 144.85' y = 31.28' k = 74.30' p = 3.97'	SPIRAL 17 - RAMP J P.I. STA. 11+85.53 Ls = 150.00' $\theta s = 28^\circ 38' 52''$ LT = 101.34' ST = 51.22' x = 146.29' y = 24.56' k = 74.38' p = 6.19'	SPIRAL 18 - RAMP M P.I. STA. 0+51.22 Ls = 150.00' $\theta s = 28^\circ 38' 52''$ LT = 101.34' ST = 51.22' x = 146.29' y = 24.56' k = 74.38' p = 6.19'
--	--	---

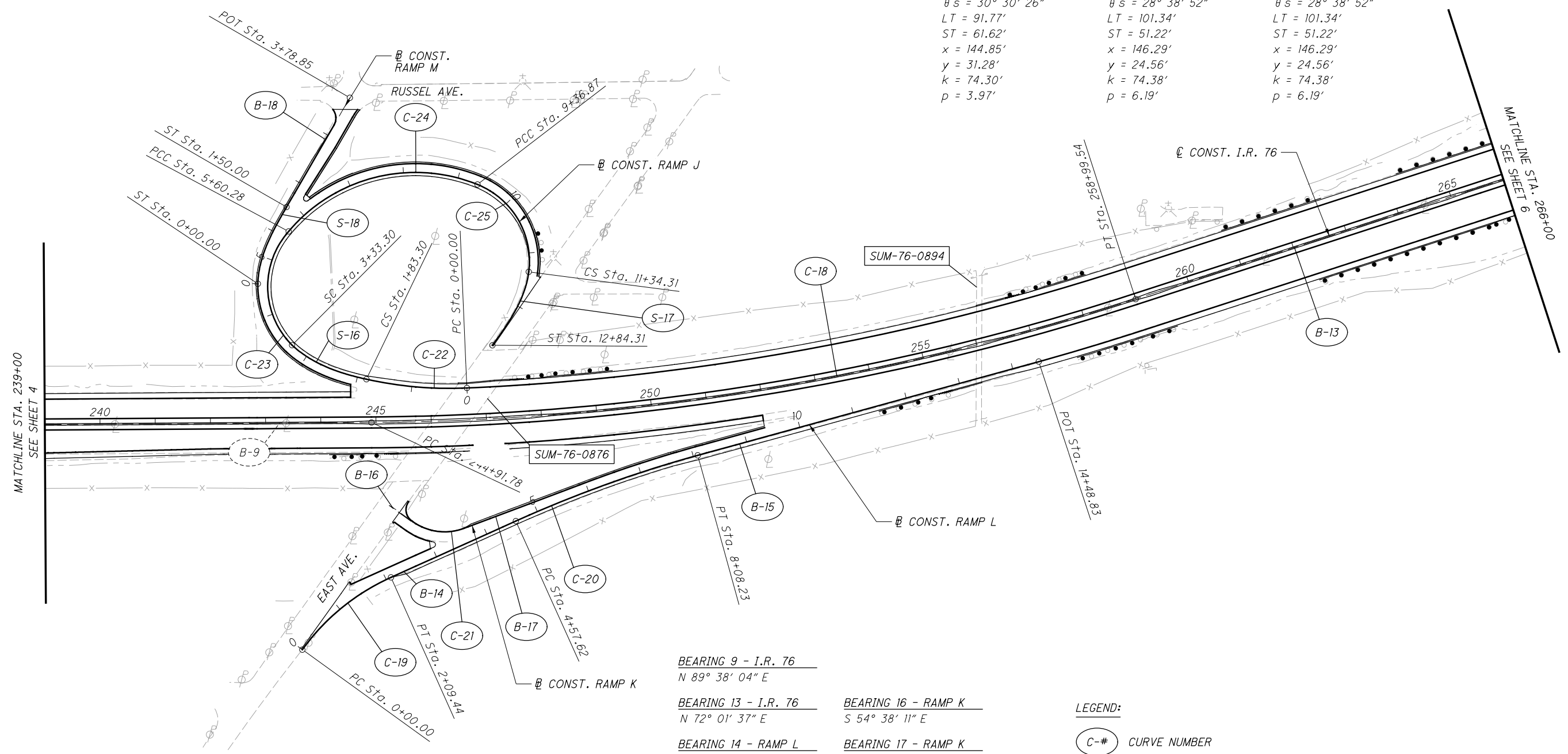

BEARING 9 - I.R. 76 N 89° 38' 04" E	BEARING 16 - RAMP K S 54° 38' 11" E
BEARING 13 - I.R. 76 N 72° 01' 37" E	BEARING 17 - RAMP K N 69° 25' 33" E
BEARING 14 - RAMP L N 65° 45' 28" E	BEARING 18 - RAMP M N 30° 04' 12" E
BEARING 15 - RAMP L N 74° 38' 48" E	

LEGEND:

- C-# CURVE NUMBER
- S-# SPIRAL NUMBER
- B-# BEARING NUMBER
- RE-SURFACING LIMITS

*THERE ARE NO EXISTING LANDSCAPED AREAS WITHIN THE PROJECT LIMITS

P:\02329_SUM-76_7T\Design\Roadway\Sheets\02329_GBI01.dgn Sheet 8/7/2020 11:28:53 AM milutes

MATCHLINE STA. 239+00
SEE SHEET 4

MATCHLINE STA. 266+00
SEE SHEET 6

SUM-76 / 77 / 8 -
SCHEMATIC PLAN - I.R. 76
STA. 239+00 TO STA. 266+00

8.24 / 9.74 / 0.00

CURVE 26 - RAMP EN
 P.I. Sta. 104+15.59
 $\Delta = 12^\circ 25' 08''$ (RT)
 $Dc = 1^\circ 30' 00''$
 $R = 3,819.72'$
 $T = 415.59'$
 $L = 827.93'$
 $E = 22.54'$
 $C = 826.31'$
 C.B. = N 84° 45' 24" E

CURVE 27 - RAMP EN
 P.I. Sta. 110+78.60
 $\Delta = 2^\circ 50' 29''$ (LT)
 $Dc = 1^\circ 00' 00''$
 $R = 5,729.58'$
 $T = 142.10'$
 $L = 284.14'$
 $E = 1.76'$
 $C = 284.11'$
 C.B. = N 89° 32' 43" E

CURVE 28 - RAMP EN
 P.I. Sta. 119+63.71
 $\Delta = 6^\circ 02' 03''$ (LT)
 $Dc = 2^\circ 00' 10''$
 $R = 2,860.74'$
 $T = 150.78'$
 $L = 301.28'$
 $E = 3.97'$
 $C = 301.14'$
 C.B. = N 85° 06' 27" E

CURVE 29 - RAMP SW
 P.I. Sta. 123+33.46
 $\Delta = 6^\circ 42' 49''$ (LT)
 $Dc = 2^\circ 00' 01''$
 $R = 2,864.27'$
 $T = 168.00'$
 $L = 335.62'$
 $E = 4.92'$
 $C = 335.43'$
 C.B. = N 84° 46' 04" E

BEARING 13 - I.R. 76
 N 72° 01' 37" E

BEARING 20 - RAMP G
 N 83° 27' 33" E

BEARING 21 - RAMP EN
 S 89° 02' 02" E

BEARING 22 - RAMP EN
 N 88° 07' 29" E

BEARING 23 - I.R. 76
 N 88° 07' 28" E

CURVE 30 - I.R. 76
 P.I. Sta. 276+42.53
 $\Delta = 16^\circ 05' 50''$ (RT)
 $Dc = 0^\circ 59' 57''$
 $R = 5,733.85'$
 $T = 810.80'$
 $L = 1,610.92'$
 $E = 57.04'$
 $C = 1,605.63'$
 C.B. = N 80° 04' 32" E

CURVE 31 - RAMP G
 P.I. Sta. 1+62.68
 $\Delta = 9^\circ 44' 14''$ (RT)
 $Dc = 3^\circ 00' 00''$
 $R = 1,909.86'$
 $T = 162.68'$
 $L = 324.57'$
 $E = 6.92'$
 $C = 324.18'$
 C.B. = N 78° 22' 23" E

CURVE 32 - RAMP G
 P.I. Sta. 9+88.01
 $\Delta = 5^\circ 01' 53''$ (RT)
 $Dc = 2^\circ 00' 00''$
 $R = 2,864.79'$
 $T = 125.87'$
 $L = 251.57'$
 $E = 2.76'$
 $C = 251.49'$
 C.B. = N 87° 17' 04" E

LEGEND:
 (C-#) CURVE NUMBER
 (S-#) SPIRAL NUMBER
 (B-#) BEARING NUMBER

RE-SURFACING LIMITS

*THERE ARE NO EXISTING LANDSCAPED AREAS WITHIN THE PROJECT LIMITS

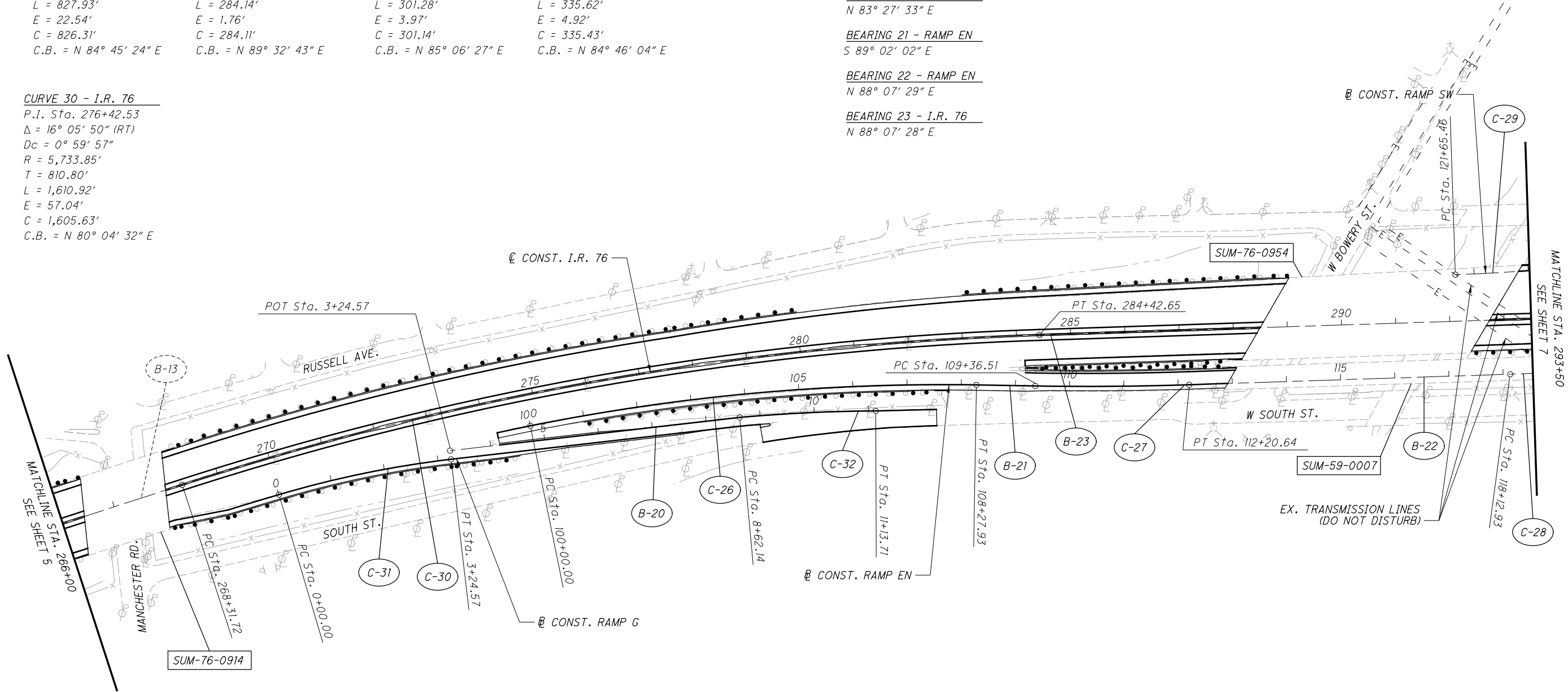

CALCULATED
 MLL
 CHECKED
 JTJ

SCHEMATIC PLAN - I.R. 76
STA. 266+00 TO STA. 293+50

SUM-76 / 77 / 8 -
8.24 / 9.74 / 0.00

P:\02329_SUM-76_77\Design\Roadway\Sheets\02329_GBI02.dgn Sheet 12/16/2020 11:21:51AM mlutes

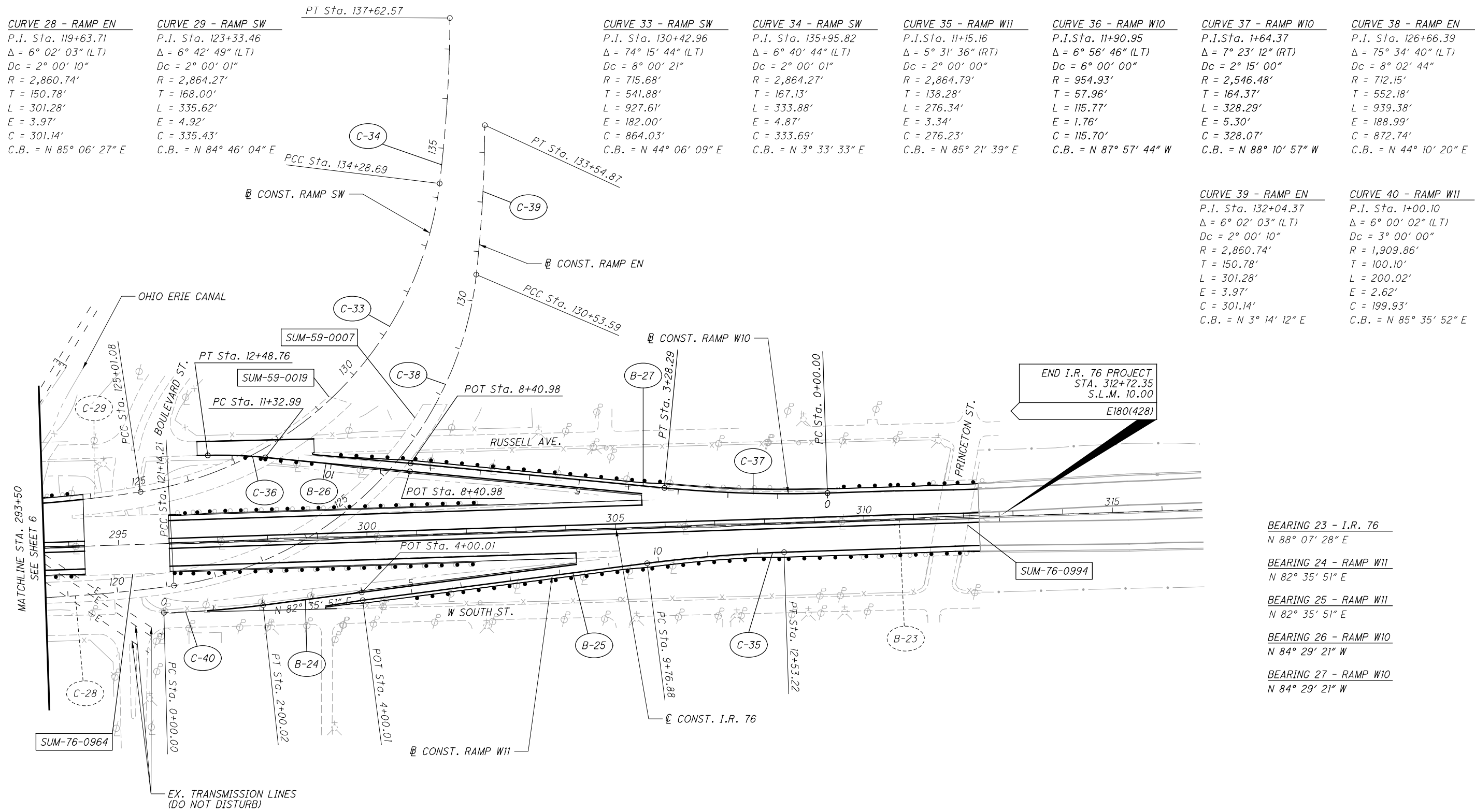

CURVE 28 - RAMP EN
 P.I. Sta. 119+63.71
 $\Delta = 6^\circ 02' 03''$ (LT)
 $Dc = 2^\circ 00' 10''$
 $R = 2,860.74'$
 $T = 150.78'$
 $L = 301.28'$
 $E = 3.97'$
 $C = 301.14'$
 C.B. = N 85° 06' 27" E

CURVE 29 - RAMP SW
 P.I. Sta. 123+33.46
 $\Delta = 6^\circ 42' 49''$ (LT)
 $Dc = 2^\circ 00' 01''$
 $R = 2,864.27'$
 $T = 168.00'$
 $L = 335.62'$
 $E = 4.92'$
 $C = 335.43'$
 C.B. = N 84° 46' 04" E

CURVE 33 - RAMP SW
 P.I. Sta. 130+42.96
 $\Delta = 74^\circ 15' 44''$ (LT)
 $Dc = 8^\circ 00' 21''$
 $R = 715.68'$
 $T = 541.88'$
 $L = 927.61'$
 $E = 182.00'$
 $C = 864.03'$
 C.B. = N 44° 06' 09" E

CURVE 34 - RAMP SW
 P.I. Sta. 135+95.82
 $\Delta = 6^\circ 40' 44''$ (LT)
 $Dc = 2^\circ 00' 01''$
 $R = 2,864.27'$
 $T = 167.13'$
 $L = 333.88'$
 $E = 4.87'$
 $C = 333.69'$
 C.B. = N 3° 33' 33" E

CURVE 35 - RAMP W11
 P.I. Sta. 11+15.16
 $\Delta = 5^\circ 31' 36''$ (RT)
 $Dc = 2^\circ 00' 00''$
 $R = 2,864.79'$
 $T = 138.28'$
 $L = 276.34'$
 $E = 3.34'$
 $C = 276.23'$
 C.B. = N 85° 21' 39" E

CURVE 36 - RAMP W10
 P.I. Sta. 11+90.95
 $\Delta = 6^\circ 56' 46''$ (LT)
 $Dc = 6^\circ 00' 00''$
 $R = 954.93'$
 $T = 57.96'$
 $L = 115.77'$
 $E = 1.76'$
 $C = 115.70'$
 C.B. = N 87° 57' 44" W

CURVE 37 - RAMP W10
 P.I. Sta. 1+64.37
 $\Delta = 7^\circ 23' 12''$ (RT)
 $Dc = 2^\circ 15' 00''$
 $R = 2,546.48'$
 $T = 164.37'$
 $L = 328.29'$
 $E = 5.30'$
 $C = 328.07'$
 C.B. = N 88° 10' 57" W

CURVE 38 - RAMP EN
 P.I. Sta. 126+66.39
 $\Delta = 75^\circ 34' 40''$ (LT)
 $Dc = 8^\circ 02' 44''$
 $R = 712.15'$
 $T = 552.18'$
 $L = 939.38'$
 $E = 188.99'$
 $C = 872.74'$
 C.B. = N 44° 10' 20" E

CURVE 39 - RAMP EN
 P.I. Sta. 132+04.37
 $\Delta = 6^\circ 02' 03''$ (LT)
 $Dc = 2^\circ 00' 10''$
 $R = 2,860.74'$
 $T = 150.78'$
 $L = 301.28'$
 $E = 3.97'$
 $C = 301.14'$
 C.B. = N 3° 14' 12" E

CURVE 40 - RAMP W11
 P.I. Sta. 1+00.10
 $\Delta = 6^\circ 00' 02''$ (LT)
 $Dc = 3^\circ 00' 00''$
 $R = 1,909.86'$
 $T = 100.10'$
 $L = 200.02'$
 $E = 2.62'$
 $C = 199.93'$
 C.B. = N 85° 35' 52" E



SUM-76 / 77 / 8 - SCHEMATIC PLAN - I.R. 76
STA. 293+50 TO END I.R. 76 PROJECT

- BEARING 23 - I.R. 76**
N 88° 07' 28" E
- BEARING 24 - RAMP W11**
N 82° 35' 51" E
- BEARING 25 - RAMP W11**
N 82° 35' 51" E
- BEARING 26 - RAMP W10**
N 84° 29' 21" W
- BEARING 27 - RAMP W10**
N 84° 29' 21" W

LEGEND:

- C-# CURVE NUMBER
- S-# SPIRAL NUMBER
- B-# BEARING NUMBER
- RE-SURFACING LIMITS

*THERE ARE NO EXISTING LANDSCAPED AREAS WITHIN THE PROJECT LIMITS

CURVE 41 - I.R. 77 (NB)
 P.I. Sta. 517+22.20
 $\Delta = 31^\circ 58' 00''$ (RT)
 $Dc = 2^\circ 30' 00''$
 $R = 2,291.83'$
 $T = 656.45'$
 $L = 1,278.67'$
 $E = 92.16'$
 $C = 1,262.15'$
 C.B. = N 20° 46' 03" W

CURVE 42 - I.R. 77 (SB)
 P.I. Sta. 514+77.98
 $\Delta = 33^\circ 58' 00''$ (RT)
 $Dc = 2^\circ 00' 00''$
 $R = 2,864.79'$
 $T = 874.94'$
 $L = 1,698.33'$
 $E = 130.63'$
 $C = 1,673.57'$
 C.B. = N 20° 46' 03" W

CURVE 43 - RAMP S11
 P.I. Sta. 4+54.58
 $\Delta = 16^\circ 48' 40''$ (RT)
 $Dc = 2^\circ 30' 00''$
 $R = 2,291.83'$
 $T = 338.66'$
 $L = 672.45'$
 $E = 24.89'$
 $C = 670.04'$
 C.B. = N 14° 22' 02" W

CURVE 44 - RAMP S11
 P.I. Sta. 11+62.36
 $\Delta = 6^\circ 11' 58''$ (RT)
 $Dc = 2^\circ 00' 00''$
 $R = 2,864.79'$
 $T = 155.14'$
 $L = 309.97'$
 $E = 4.20'$
 $C = 309.82'$
 C.B. = N 2° 51' 43" W

CURVE 45 - RAMP S12
 P.I. Sta. 2+24.41
 $\Delta = 4^\circ 29' 09''$ (RT)
 $Dc = 1^\circ 00' 00''$
 $R = 5,729.58'$
 $T = 224.41'$
 $L = 448.58'$
 $E = 4.39'$
 $C = 448.47'$
 C.B. = S 2° 28' 51" W

BEARING 28 - I.R. 77
 N 0° 14' 16" E

BEARING 29 - RAMP S11
 N 22° 46' 22" W

BEARING 30 - RAMP S11
 N 5° 57' 42" W

BEARING 31 - RAMP S12
 S 4° 43' 25" W

BEARING 32 - RAMP S12
 S 4° 43' 25" W

SPIRAL 19 - I.R. 77 (NB)
 P.I. STA. 524+77.85
 $Ls = 400.00'$
 $\theta s = 5^\circ 00' 00''$
 $LT = 266.77'$
 $ST = 133.43'$
 $x = 399.70'$
 $y = 11.63'$
 $k = 199.95'$
 $p = 2.91'$

SPIRAL 20 - I.R. 77 (SB)
 P.I. STA. 524+34.77
 $Ls = 400.00'$
 $\theta s = 4^\circ 00' 00''$
 $LT = 266.73'$
 $ST = 51.22'$
 $x = 399.81'$
 $y = 9.31'$
 $k = 199.97'$
 $p = 2.33'$

SPIRAL 20A - RAMP B
 P.I. STA. 4+99.67
 $Ls = 200.00'$
 $\theta s = 8^\circ 00' 00''$
 $LT = 133.47'$
 $ST = 66.79'$
 $x = 199.61'$
 $y = 9.30'$
 $k = 99.94'$
 $p = 2.33'$

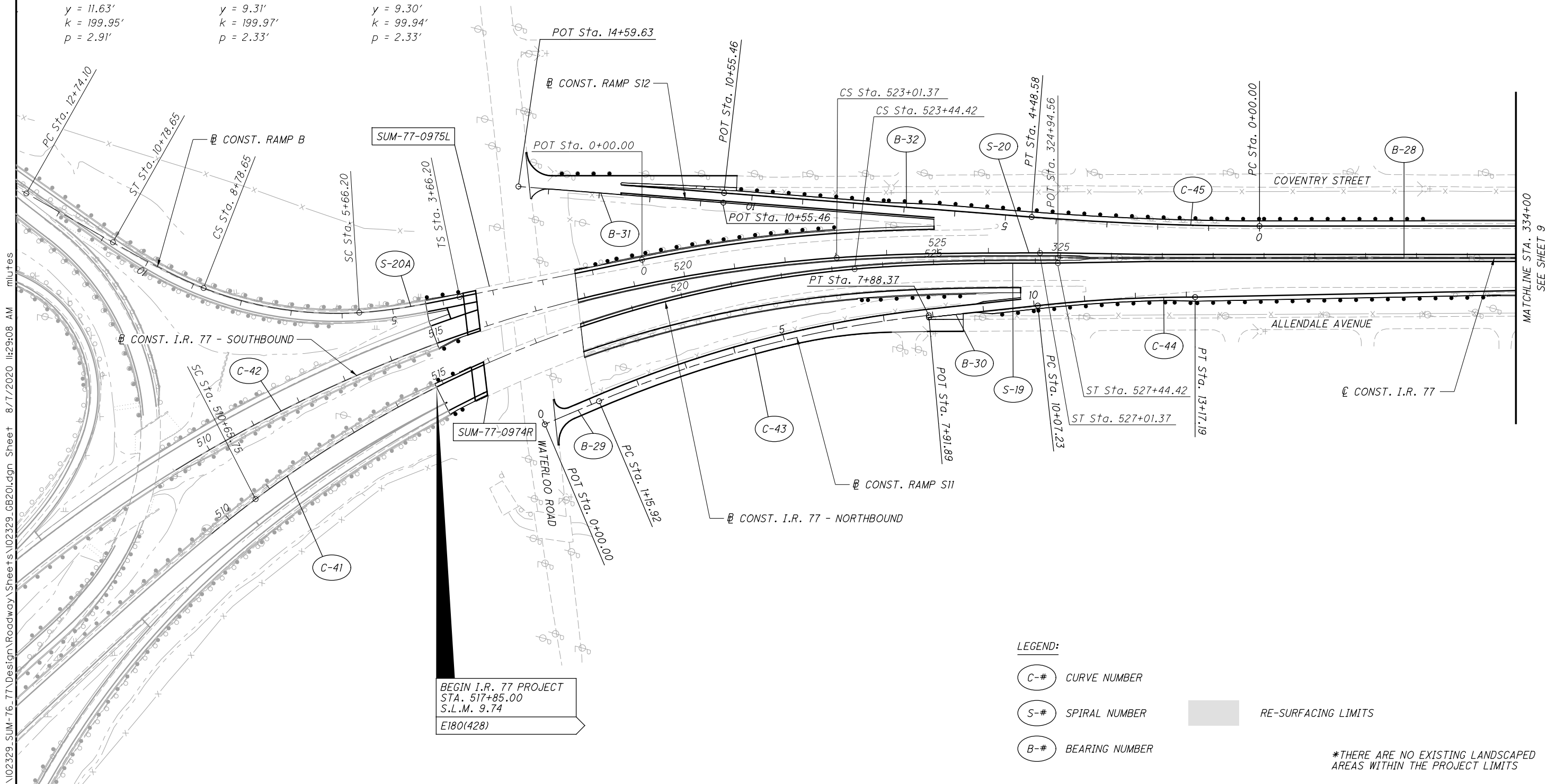

P:\102329_SUM-76_77\Design\Roadway\Sheets\102329_GB201.dgn Sheet 8/7/2020 11:29:08 AM ml:tes

CALCULATED
 MLL
 CHECKED
 JTJ

0 100 200
 HORIZONTAL
 SCALE IN FEET

SUM-76 / 77 / 8 - SCHEMATIC PLAN - I.R. 77
BEGIN I.R. 77 PROJECT TO STA. 334+00

8.24 / 9.74 / 0.00



0 100 200
HORIZONTAL SCALE IN FEET
CALCULATED MLL CHECKED JTW

CURVE 46 - I.R. 77 P.I. Sta. 355+29.94 Δ = 7° 43' 16" (LT) Dc = 1° 28' 15" R = 3,895.54' T = 262.88' L = 524.96' E = 8.86' C = 524.56' C.B. = N 3° 37' 34" W	CURVE 47 - RAMP S9 P.I. Sta. 0+70.10 Δ = 3° 09' 13" (RT) Dc = 2° 15' 00" R = 2,546.48' T = 70.10' L = 140.17' E = 0.96' C = 140.15' C.B. = N 1° 48' 53" E	CURVE 48 - RAMP S9 P.I. Sta. 3+62.16 Δ = 1° 26' 03" (LT) Dc = 1° 00' 00" R = 5,729.58' T = 71.71' L = 143.41' E = 0.45' C = 143.41' C.B. = N 2° 40' 28" E	CURVE 49 - RAMP S9 P.I. Sta. 9+25.69 Δ = 4° 08' 17" (RT) Dc = 4° 00' 00" R = 1,432.39' T = 51.75' L = 103.45' E = 0.93' C = 103.43' C.B. = N 4° 01' 35" E	CURVE 50 - RAMP S9 P.I. Sta. 12+04.24 Δ = 5° 51' 28" (LT) Dc = 4° 00' 00" R = 1,432.39' T = 73.28' L = 146.44' E = 1.87' C = 146.38' C.B. = N 3° 10' 00" E	CURVE 51 - RAMP S10 P.I. Sta. 8+08.55 Δ = 8° 02' 12" (RT) Dc = 1° 00' 00" R = 5,729.58' T = 402.50' L = 803.68' E = 14.12' C = 803.02' C.B. = S 3° 46' 50" E	CURVE 52 - RAMP S10 P.I. Sta. 1+50.53 Δ = 8° 04' 51" (LT) Dc = 4° 00' 00" R = 1,432.39' T = 101.18' L = 202.02' E = 3.57' C = 201.85' C.B. = S 3° 45' 31" E
--	---	---	---	--	--	---

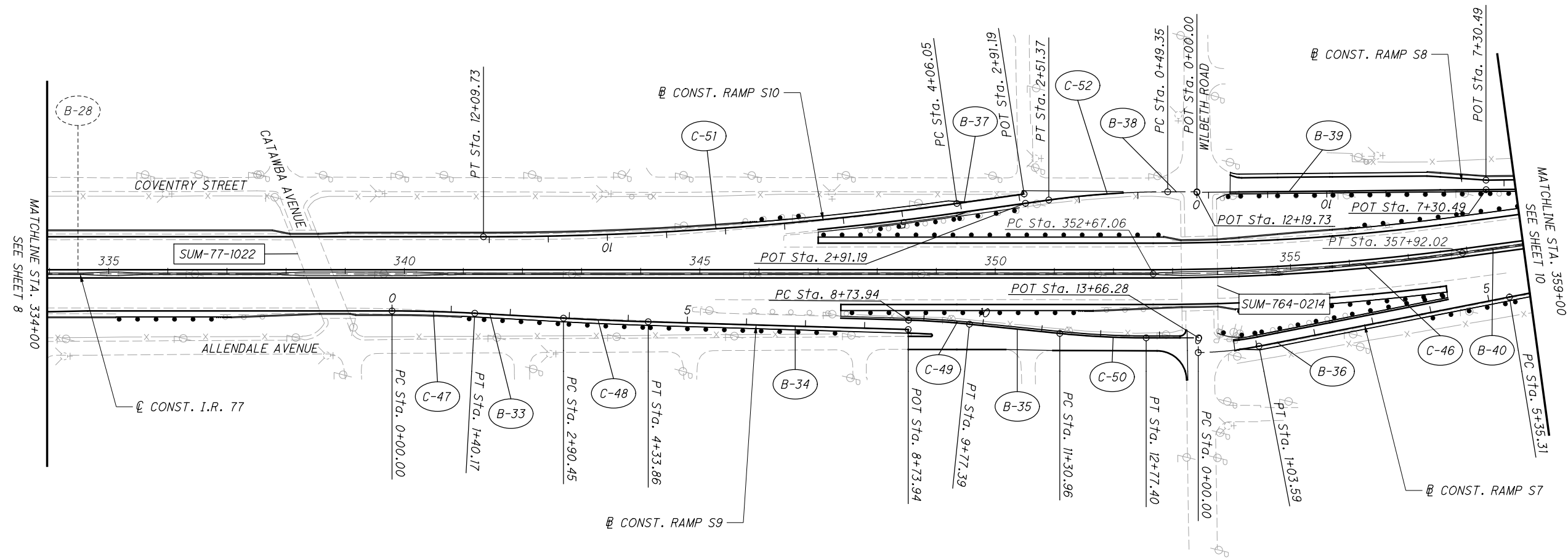

BEARING 28 - I.R. 77 N 0° 14' 16" E	BEARING 35 - RAMP S9 N 6° 05' 44" E	BEARING 38 - RAMP S10 S 0° 16' 55" E
BEARING 33 - RAMP S9 N 3° 23' 30" E	BEARING 36 - RAMP S7 N 10° 52' 58" W	BEARING 39 - RAMP S8 S 0° 18' 36" E
BEARING 34 - RAMP S9 N 1° 57' 27" E	BEARING 37 - RAMP S10 S 7° 47' 56" E	BEARING 40 - I.R. 77 N 7° 29' 12" W

LEGEND:

- C-# CURVE NUMBER
- S-# SPIRAL NUMBER
- B-# BEARING NUMBER
- RE-SURFACING LIMITS

*THERE ARE NO EXISTING LANDSCAPED AREAS WITHIN THE PROJECT LIMITS

**SUM-76 / 77 / 8-
8.24 / 9.74 / 0.00**

SCHEMATIC PLAN - I.R. 77
STA. 334+00 TO STA. 359+00

9
138

P:\102329_SUM-76_77\Design\Roadway\Sheets\102329_GB202.dgn Sheet 8/7/2020 11:29:00 AM mil/tes

CURVE 53 - I.R. 77
 P.I. Sta. 369+05.21
 $\Delta = 7^\circ 52' 08''$ (RT)
 $Dc = 0^\circ 59' 44''$
 $R = 5,756.02'$
 $T = 395.88'$
 $L = 790.52'$
 $E = 13.60'$
 $C = 789.88'$
 C.B. = N $3^\circ 33' 08''$ W

CURVE 54 - RAMP S5
 P.I. Sta. 3+14.00
 $\Delta = 7^\circ 12' 55''$ (LT)
 $Dc = 2^\circ 30' 00''$
 $R = 2,291.83'$
 $T = 144.50'$
 $L = 288.61'$
 $E = 4.55'$
 $C = 288.42'$
 C.B. = N $3^\circ 52' 35''$ W

CURVE 55A - RAMP S8
 P.I. Sta. 3+26.39
 $\Delta = 6^\circ 31' 15''$ (RT)
 $Dc = 1^\circ 00' 00''$
 $R = 5,787.58'$
 $T = 326.39'$
 $L = 652.08'$
 $E = 9.29'$
 $C = 651.72'$
 C.B. = S $3^\circ 34' 13''$ E

CURVE 56 - RAMP S6
 P.I. Sta. 13+18.96
 $\Delta = 4^\circ 40' 36''$ (LT)
 $Dc = 4^\circ 00' 00''$
 $R = 1,432.39'$
 $T = 58.49'$
 $L = 116.91'$
 $E = 1.19'$
 $C = 116.88'$
 C.B. = S $2^\circ 35' 54''$ W

CURVE 56A - RAMP S7
 P.I. Sta. 6+94.06
 $\Delta = 1^\circ 35' 15''$ (RT)
 $Dc = 0^\circ 30' 00''$
 $R = 11,459.16'$
 $T = 158.76'$
 $L = 317.49'$
 $E = 1.10'$
 $C = 317.48'$
 C.B. = N $10^\circ 05' 20''$ W

BEARING 40 - I.R. 77
 N $7^\circ 29' 12''$ W

BEARING 41 - I.R. 77
 N $0^\circ 22' 56''$ E

BEARING 44 - RAMP S8
 S $0^\circ 18' 36''$ E

BEARING 42 - RAMP S5
 N $0^\circ 16' 08''$ E

BEARING 45 - RAMP S6
 S $0^\circ 15' 36''$ W

BEARING 43 - RAMP S5
 N $7^\circ 29' 03''$ W

BEARING 46 - RAMP S6
 S $4^\circ 56' 12''$ W

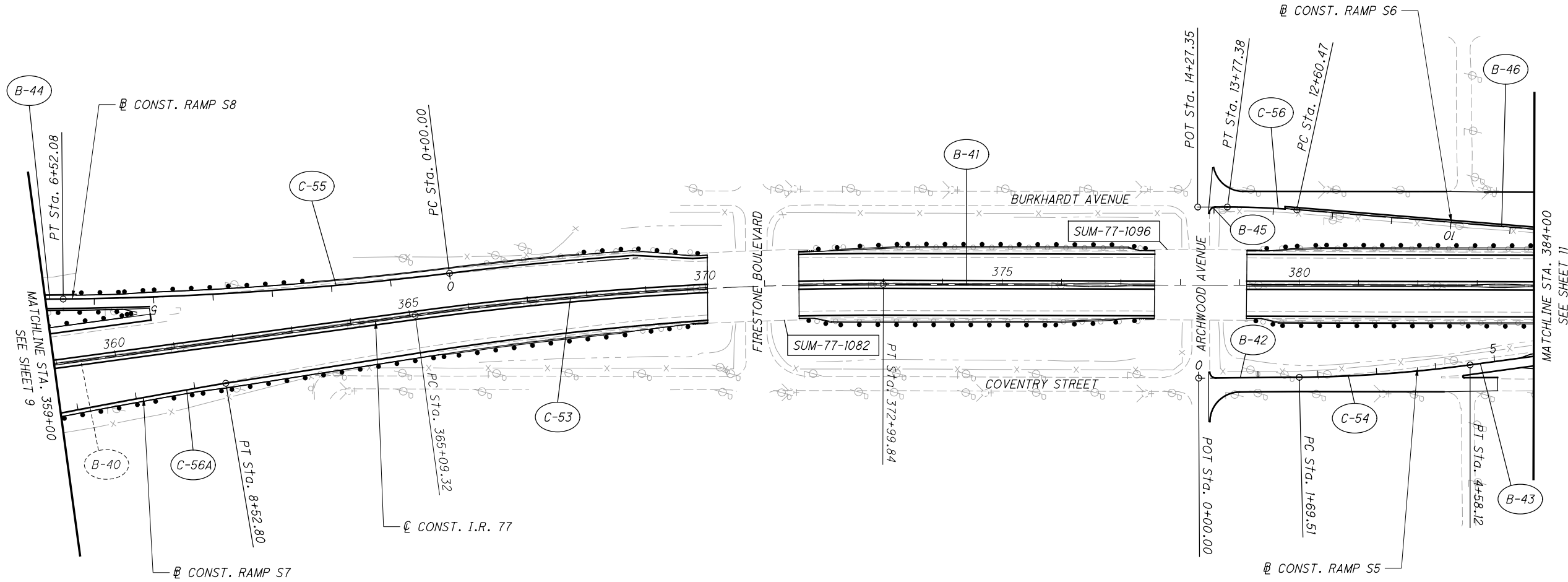

LEGEND:

(C-#) CURVE NUMBER

(S-#) SPIRAL NUMBER

(B-#) BEARING NUMBER

RE-SURFACING LIMITS

*THERE ARE NO EXISTING LANDSCAPED AREAS WITHIN THE PROJECT LIMITS

CALCULATED
 MLL
 CHECKED
 JTJ

0 100 200
 HORIZONTAL SCALE IN FEET

SUM-76 / 77 / 8-
 8.24 / 9.74 / 0.00

SCHEMATIC PLAN - I.R. 77
 STA. 359+00 TO STA. 384+00

CURVE 57 - I.R. 77
 P.I. Sta. 404+25.71
 $\Delta = 2^\circ 39' 13''$ (LT)
 $Dc = 0^\circ 28' 00''$
 $R = 12,777.67'$
 $T = 284.37'$
 $L = 568.63'$
 $E = 3.29'$
 $C = 568.58'$
 C.B. = N 0° 56' 41" W

CURVE 58 - RAMP S5
 P.I. Sta. 9+18.93
 $\Delta = 6^\circ 26' 03''$ (RT)
 $Dc = 3^\circ 00' 00''$
 $R = 1,909.86'$
 $T = 107.35'$
 $L = 214.47'$
 $E = 3.01'$
 $C = 214.36'$
 C.B. = N 4° 16' 01" W

CURVE 59 - RAMP S6
 P.I. Sta. 1+01.26
 $\Delta = 4^\circ 33' 16''$ (RT)
 $Dc = 2^\circ 15' 00''$
 $R = 2,546.48'$
 $T = 101.26'$
 $L = 202.42'$
 $E = 2.01'$
 $C = 202.37'$
 C.B. = S 2° 39' 34" W

CURVE 60 - S.R. 8
 P.I. Sta. 4302+70.06
 $\Delta = 8^\circ 03' 13''$ (RT)
 $Dc = 0^\circ 30' 00''$
 $R = 11,459.16'$
 $T = 806.69'$
 $L = 1,610.73'$
 $E = 28.36'$
 $C = 1,609.40'$
 C.B. = N 1° 43' 21" E

BEARING 41 - I.R. 77
 N 0° 22' 56" E

BEARING 43 - RAMP S5
 N 7° 29' 03" W

BEARING 46 - RAMP S6
 S 4° 56' 12" W

BEARING 47 - RAMP S5
 N 7° 29' 03" W

BEARING 48 - RAMP S6
 S 4° 56' 12" W

BEARING 49 - S.R. 8
 N 2° 18' 05" W

BEARING 50 - RAMP S6
 S 4° 56' 12" W





 HORIZONTAL SCALE IN FEET
 CALCULATED: MLL
 CHECKED: JTJ

SUSPEND I.R. 77 PROJECT
 STA. 4292+31.73
 S.L.M. 11.54
 E180(428)

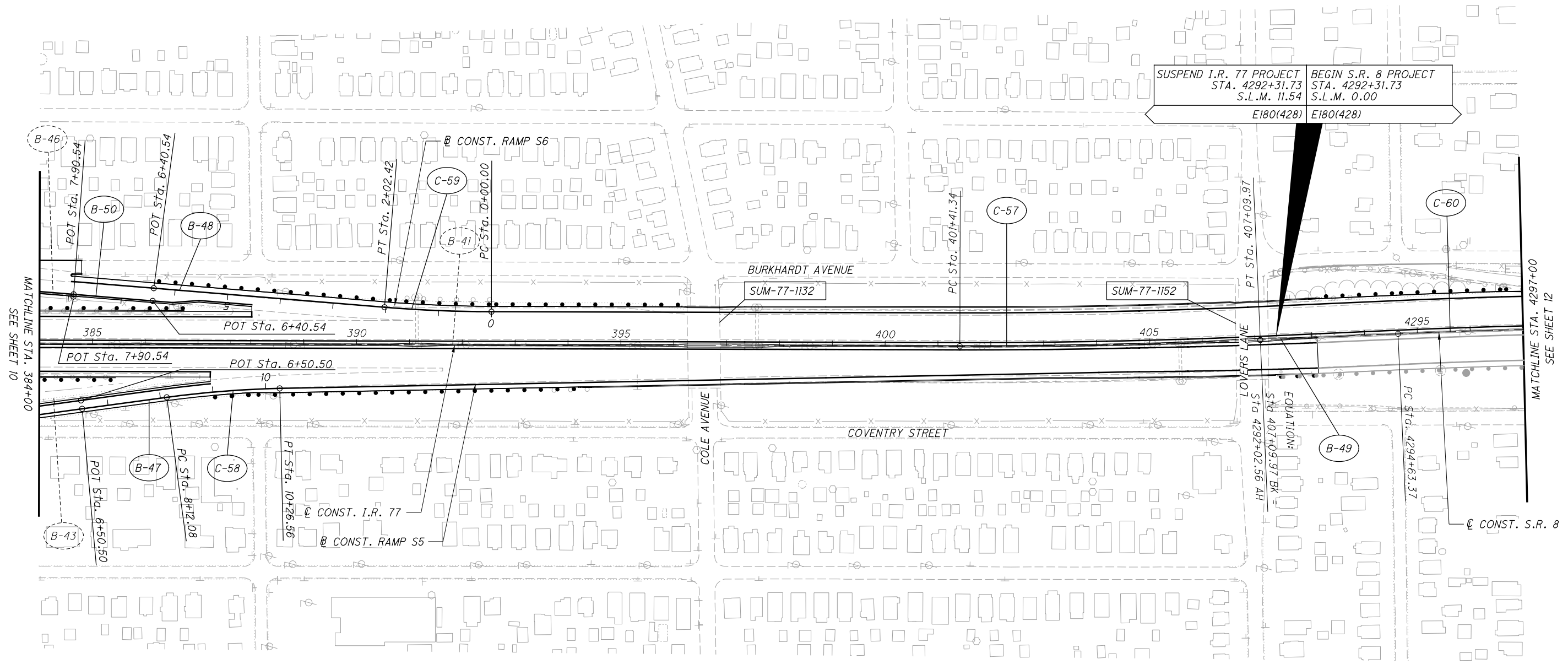
BEGIN S.R. 8 PROJECT
 STA. 4292+31.73
 S.L.M. 0.00
 E180(428)



LEGEND:

-  CURVE NUMBER
-  SPIRAL NUMBER
-  BEARING NUMBER

 RE-SURFACING LIMITS

*THERE ARE NO EXISTING LANDSCAPED AREAS WITHIN THE PROJECT LIMITS

P:\102329_SUM-76_77\Design\Roadway\Sheets\102329_GB204.dgn Sheet 8/7/2020 11:29:31 AM mlutes

SCHEMATIC PLAN - I.R. 77 / S.R. 8
STA. 384+00 TO STA. 4297+00

SUM-76 / 77 / 8-
8.24 / 9.74 / 0.00

CURVE 60 - S.R. 8
 P.I. Sta. 4302+70.06
 $\Delta = 8^\circ 03' 13''$ (RT)
 $Dc = 0^\circ 30' 00''$
 $R = 11,459.16'$
 $T = 806.69'$
 $L = 1,610.73'$
 $E = 28.36'$
 $C = 1,609.40'$
 C.B. = $N 1^\circ 43' 21'' E$

CURVE 61 - RAMP N
 P.I. Sta. 3323+37.81
 $\Delta = 4^\circ 43' 07''$ (LT)
 $Dc = 1^\circ 45' 00''$
 $R = 3,274.04'$
 $T = 84.84'$
 $Lc = 169.64'$
 $Es = 1.09'$
 $C = 169.62'$
 C.B. = $N 3^\circ 26' 39'' W$

SPIRAL 21 - RAMP N
 P.I. STA. 3322+42.42
 $Ls = 200.00'$
 $\theta s = 1^\circ 45' 00''$
 $LT = 133.34'$
 $ST = 66.67'$
 $x = 199.98'$
 $y = 2.04'$
 $k = 100.00'$
 $p = 0.51'$

CURVE 62 - RAMP P
 P.I. Sta. 5340+30.08
 $\Delta = 70^\circ 03' 32''$ (RT)
 $Dc = 9^\circ 45' 00''$
 $R = 587.65'$
 $T = 411.93'$
 $L = 718.55'$
 $E = 130.00'$
 $C = 674.62'$
 C.B. = $S 50^\circ 56' 26'' W$

CURVE 63 - RAMP S
 P.I. Sta. 6339+76.37
 $\Delta = 40^\circ 00' 42''$ (LT)
 $Dc = 8^\circ 45' 00''$
 $R = 654.81'$
 $T = 238.41'$
 $L = 457.28'$
 $E = 42.05'$
 $C = 448.04'$
 C.B. = $S 4^\circ 05' 41'' E$

CURVE 64 - RAMP S
 P.I. Sta. 6347+87.51
 $\Delta = 86^\circ 29' 52''$ (LT)
 $Dc = 9^\circ 06' 00''$
 $R = 629.62'$
 $T = 592.27'$
 $L = 950.53'$
 $E = 234.79'$
 $C = 862.80'$
 C.B. = $S 67^\circ 20' 58'' E$

BEARING 51 - S.R. 8
 $N 5^\circ 44' 57'' W$

BEARING 52 - RAMP M
 $S 0^\circ 56' 10'' W$

BEARING 53 - RAMP S
 $S 15^\circ 54' 40'' W$



CALCULATED
 MLL
 CHECKED
 JTW

SUM-76 / 77 / 8 -
8.24 / 9.74 / 0.00
SCHEMATIC PLAN - S.R. 8
STA. 4297+00 TO STA. 4325+00

12
138

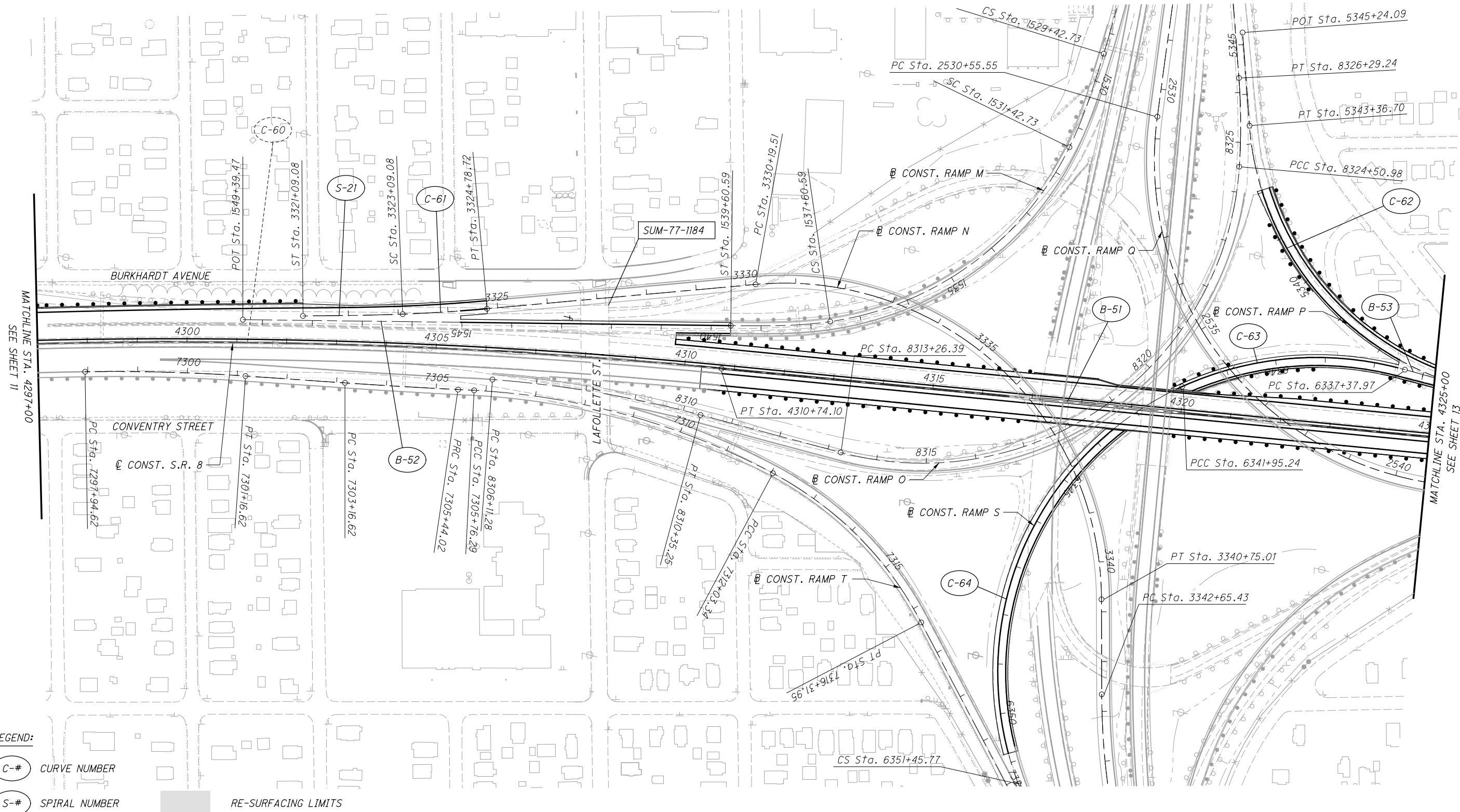

- LEGEND:**
- (C-#) CURVE NUMBER
 - (S-#) SPIRAL NUMBER
 - (B-#) BEARING NUMBER

RE-SURFACING LIMITS

*THERE ARE NO EXISTING LANDSCAPED AREAS WITHIN THE PROJECT LIMITS

P:\102329_SUM-76_77\Design\Roadway\Sheets\102329_GB205.dgn Sheet 8/7/2020 11:29:54 AM milutes

MATCHLINE STA. 4297+00
 SEE SHEET 11

MATCHLINE STA. 4325+00
 SEE SHEET 13

CURVE 62 - RAMP P
 P.I. Sta. 5340+30.08
 $\Delta = 70^\circ 03' 32''$ (RT)
 $Dc = 9^\circ 45' 00''$
 $R = 587.65'$
 $T = 411.93'$
 $L = 718.55'$
 $E = 130.00'$
 $C = 674.62'$
 C.B. = S 50° 56' 26" W

CURVE 65 - S.R. 8
 P.I. Sta. 328+39.86
 $\Delta = 6^\circ 46' 35''$ (LT)
 $Dc = 1^\circ 00' 00''$
 $R = 5,729.58'$
 $T = 339.22'$
 $L = 677.65'$
 $E = 10.03'$
 $C = 677.25'$
 C.B. = N 2° 21' 40" E

CURVE 66 - RAMP S
 P.I. Sta. 6331+97.27
 $\Delta = 10^\circ 09' 43''$ (RT)
 $Dc = 9^\circ 00' 00''$
 $R = 636.62'$
 $T = 56.60'$
 $L = 112.91'$
 $E = 2.51'$
 $C = 112.76'$
 C.B. = S 10° 49' 49" W

CURVE 67 - RAMP S1
 P.I. Sta. 4+64.41
 $\Delta = 6^\circ 11' 10''$ (RT)
 $Dc = 0^\circ 40' 00''$
 $R = 8,594.37'$
 $T = 464.41'$
 $L = 927.91'$
 $E = 12.54'$
 $C = 927.46'$
 C.B. = N 2° 03' 57" E

BEARING 51 - S.R. 8
 N 5° 44' 57" W

BEARING 53 - RAMP S
 S 15° 54' 40" W

BEARING 54 - RAMP S
 S 5° 44' 57" W

BEARING 55 - S.R. 8
 N 1° 01' 38" W

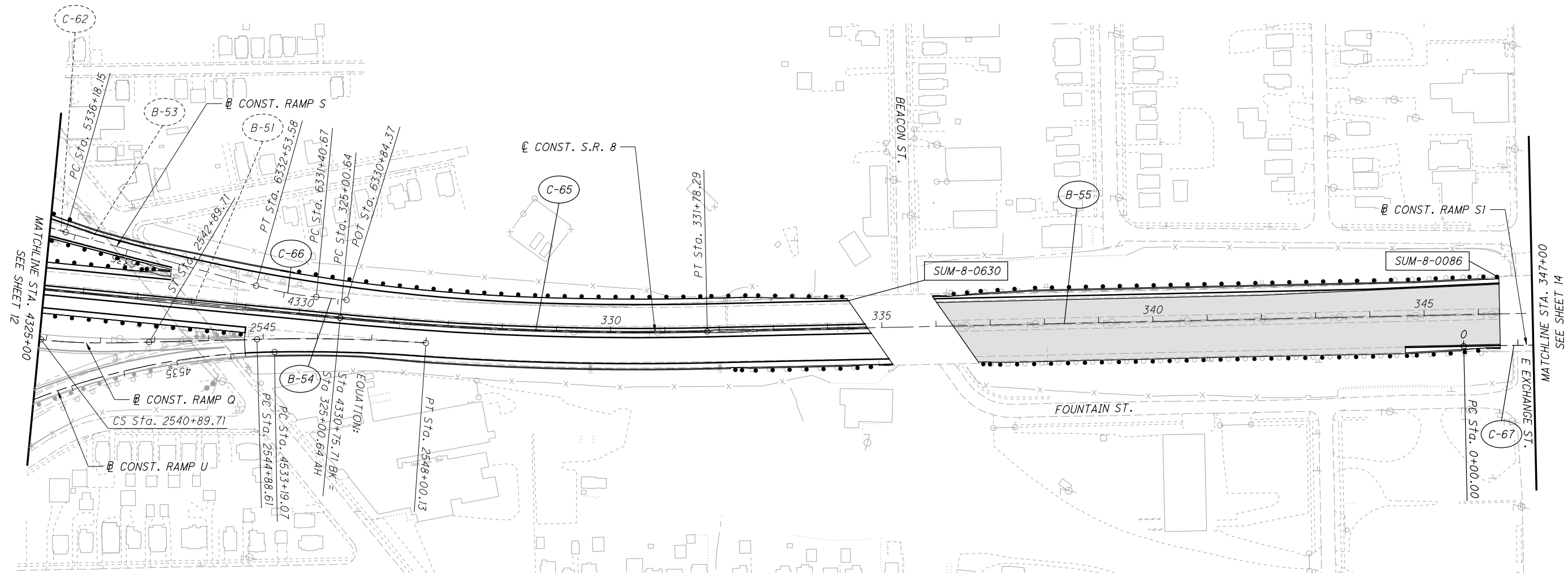

LEGEND:

- C-# CURVE NUMBER
- S-# SPIRAL NUMBER
- B-# BEARING NUMBER

RE-SURFACING LIMITS

*THERE ARE NO EXISTING LANDSCAPED AREAS WITHIN THE PROJECT LIMITS

N

0 100 200
HORIZONTAL SCALE IN FEET

CALCULATED
MILL
CHECKED
JTW

SUM-76 / 77 / 8 -
8.24 / 9.74 / 0.00

SCHEMATIC PLAN - S.R. 8
STA. 4325+00 TO STA. 347+00

P:\02329_SUM-76_77\Design\Roadway\Sheets\02329_GB206.dgn Sheet 8/7/2020 11:30:18 AM miles

CURVE 67 - RAMP S1
 P.I. Sta. 4+64.41
 $\Delta = 6^\circ 11' 10''$ (RT)
 $Dc = 0^\circ 40' 00''$
 $R = 8,594.37'$
 $T = 464.41'$
 $L = 927.91'$
 $E = 12.54'$
 $C = 927.46'$
 C.B. = N 2° 03' 57" E

CURVE 68 - S.R. 8
 P.I. Sta. 368+47.03
 $\Delta = 7^\circ 46' 07''$ (RT)
 $Dc = 0^\circ 30' 13''$
 $R = 11,375.75'$
 $T = 772.39'$
 $L = 1,542.41'$
 $E = 26.19'$
 $C = 1,541.23'$
 C.B. = N 2° 51' 26" E

CURVE 69 - RAMP S1
 P.I. Sta. 14+12.87
 $\Delta = 6^\circ 11' 54''$ (LT)
 $Dc = 3^\circ 00' 00''$
 $R = 1,909.86'$
 $T = 103.41'$
 $L = 206.61'$
 $E = 2.80'$
 $C = 206.51'$
 C.B. = N 2° 03' 35" E

CURVE 70 - RAMP T
 P.I. Sta. 56+45.82
 $\Delta = 11^\circ 00' 00''$ (RT)
 $Dc = 4^\circ 00' 00''$
 $R = 1,432.39'$
 $T = 137.92'$
 $L = 275.00'$
 $E = 6.62'$
 $C = 274.58'$
 C.B. = N 3° 31' 38" W

CURVE 71 - RAMP T
 P.I. Sta. 51+00.16
 $\Delta = 8^\circ 00' 00''$ (LT)
 $Dc = 4^\circ 00' 00''$
 $R = 1,432.39'$
 $T = 100.16'$
 $L = 200.00'$
 $E = 3.50'$
 $C = 199.84'$
 C.B. = N 5° 01' 38" W

BEARING 55 - S.R. 8
 N 1° 01' 38" W

BEARING 56 - RAMP S1
 N 1° 02' 22" W

BEARING 57 - RAMP T
 N 9° 01' 38" W



BEARING 57A - FOUNTAIN ST.
 N 1° 02' 22" W

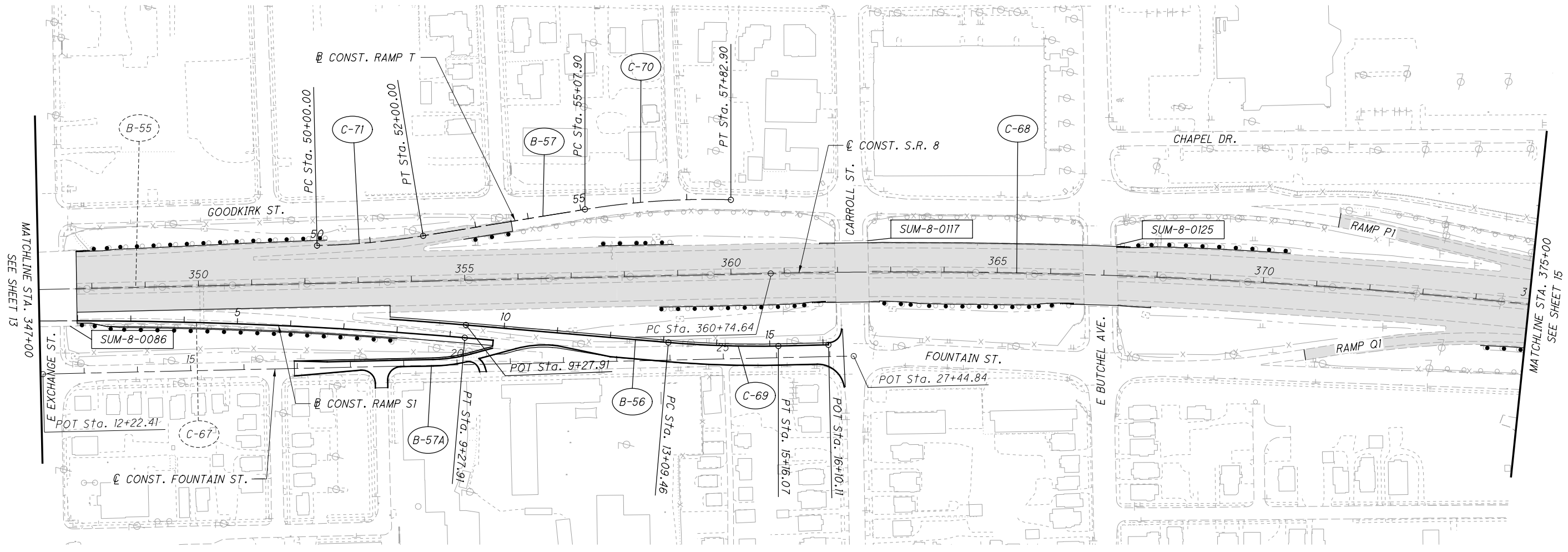

 HORIZONTAL SCALE IN FEET
 CALCULATED: MLL
 CHECKED: JTJ



LEGEND:

-  C-# CURVE NUMBER
-  S-# SPIRAL NUMBER
-  B-# BEARING NUMBER

 RE-SURFACING LIMITS

*THERE ARE NO EXISTING LANDSCAPED AREAS WITHIN THE PROJECT LIMITS

P:\102329_SUM-76_77\Design\Roadway\Sheets\102329_GB207.dgn Sheet 8/7/2020 11:30:24 AM milutes

SUM-76 / 77 / 8 - SCHEMATIC PLAN - S.R. 8
STA. 347+00 TO STA. 375+00

8.24 / 9.74 / 0.00

CURVE 68 - S.R. 8
 P.I. Sta. 368+47.03
 $\Delta = 7^\circ 46' 07''$ (RT)
 $Dc = 0^\circ 30' 13''$
 $R = 11,375.75'$
 $T = 772.39'$
 $L = 1,542.41'$
 $E = 26.19'$
 $C = 1,541.23'$
 $C.B. = N 2^\circ 51' 26'' E$

BEARING 58 - S.R. 8
 $N 6^\circ 44' 29'' W$

CALCULATED
 MLL
 CHECKED
 JTJ

0 100 200
 HORIZONTAL
 SCALE IN FEET

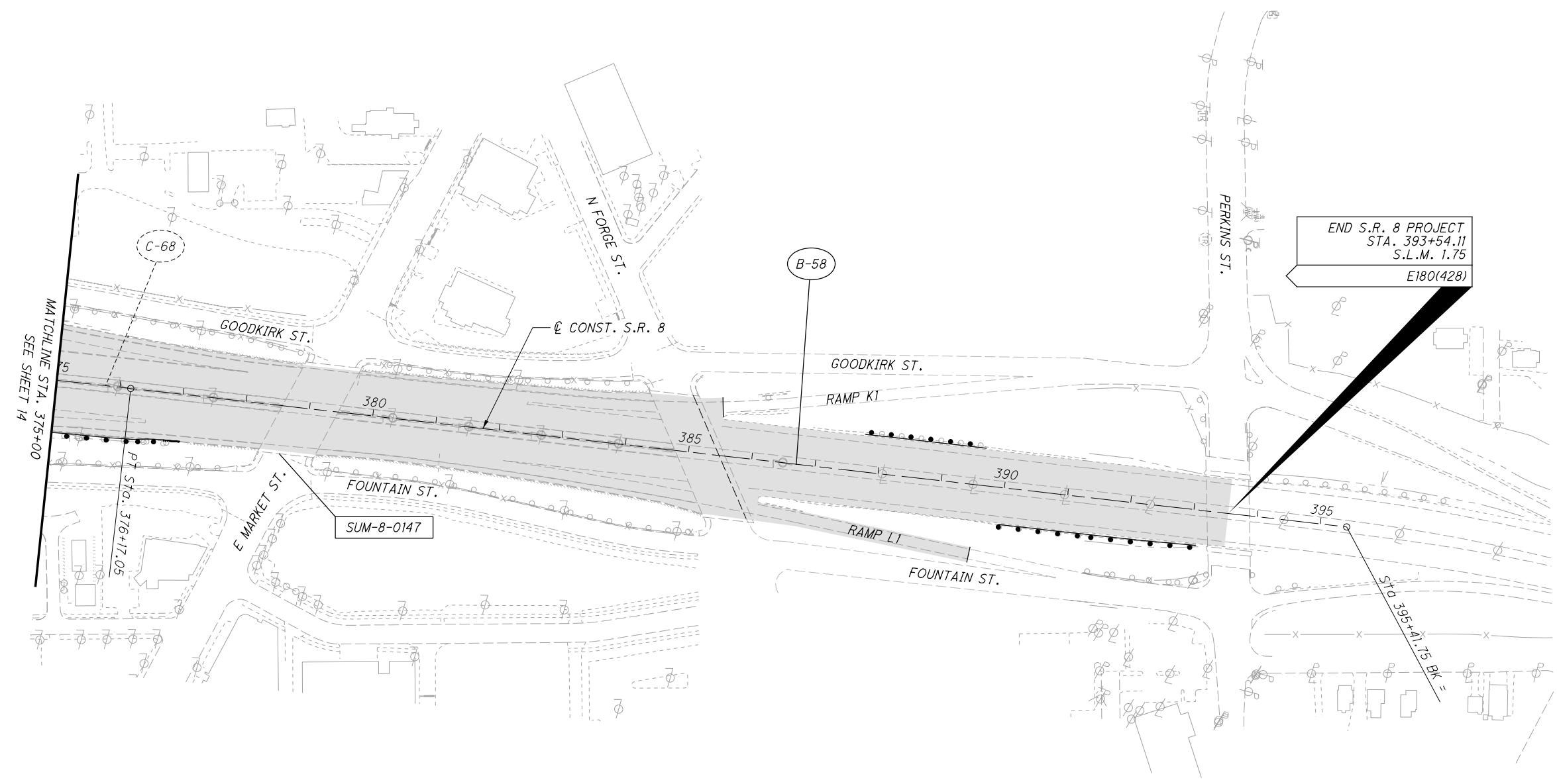

LEGEND:

- C-# CURVE NUMBER
- S-# SPIRAL NUMBER
- B-# BEARING NUMBER
- RE-SURFACING LIMITS

*THERE ARE NO EXISTING LANDSCAPED AREAS WITHIN THE PROJECT LIMITS

P:\02329_SUM-76_77\Design\Roadway\Sheets\02329_GB208.dgn Sheet 8/7/2020 11:30:30 AM mlutes

**SUM-76 / 77 / 8-
 8.24 / 9.74 / 0.00**

**SCHEMATIC PLAN - S.R. 8
 STA. 375+00 TO END S.R. 8 PROJECT**

P:\02329_SUM-76_77\Design\Roadway\Sheets\02329_GY101.dgn Sheet 8/7/2020 11:30:33 AM mlufes

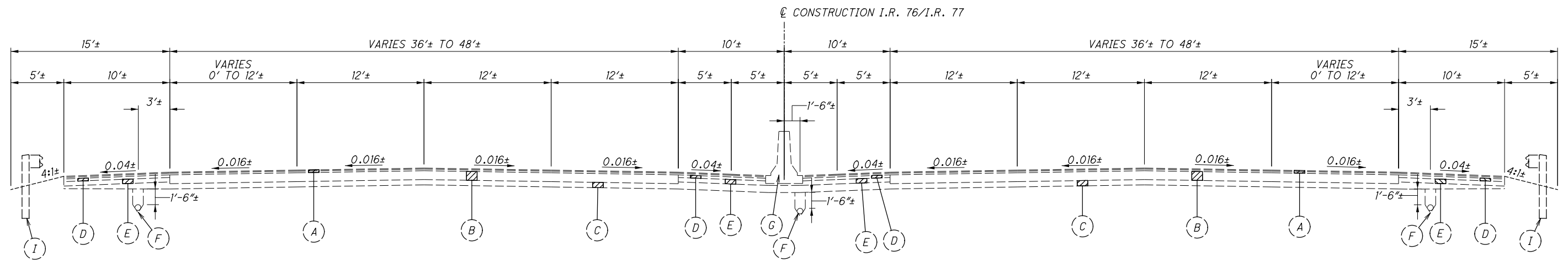

EXISTING NORMAL SECTION - I.R. 76/I.R. 77

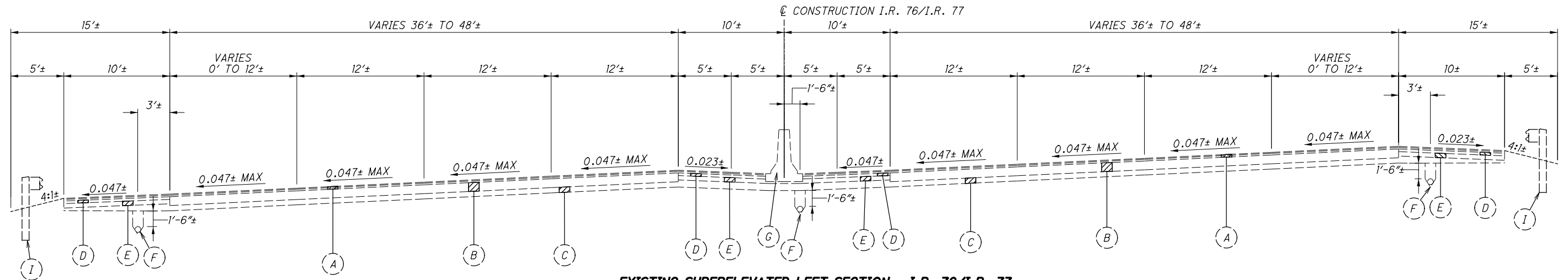

EXISTING SUPERELEVATED LEFT SECTION - I.R. 76/I.R. 77

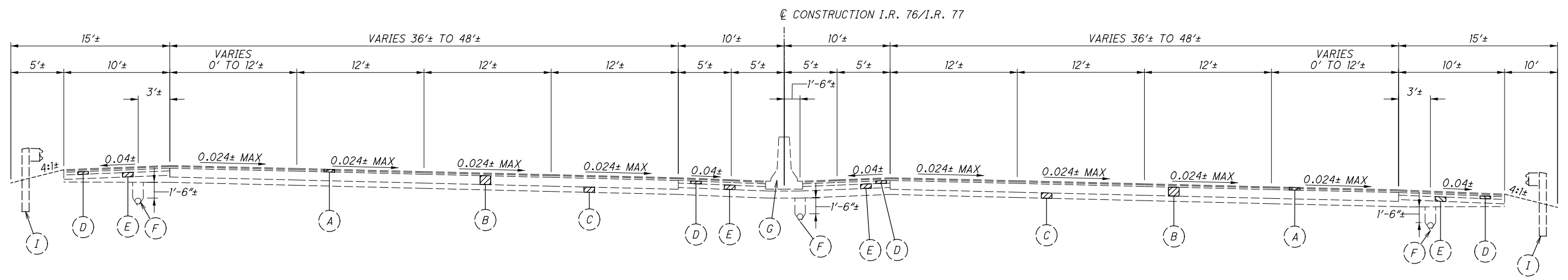

EXISTING SUPERELEVATED RIGHT SECTION - I.R. 76/I.R. 77

EXISTING LEGEND (SUM-76-8.24) (SUM-77-15.18)

- | | |
|---|--|
| (A) EX. VARIES 3"-4"± ASPHALT CONCRETE | (F) EX. UNDERDRAIN |
| (B) EX. 10"± REINFORCED CONCRETE PAVEMENT | (G) EX. CONCRETE BARRIER |
| (C) EX. 6"± SUBBASE | (H) EX. 9"± REINFORCED CONCRETE PAVEMENT |
| (D) EX. 3"± AGGREGATE BASE COURSE | (I) EX. GUARDRAIL |
| (E) EX. 5"± AGGREGATE BASE | (J) EX. 9"± BITUMINIOUS AGGREGATE BASE |

EXISTING TYPICAL SECTIONS - I.R. 76/I.R. 77

SUM-76/77/8-8.24/9.74/0.00

P:\102329_SUM-76_77\Design\Roadway\Sheets\102329_GY102.dgn Sheet 8/7/2020 11:30:35 AM mlufes

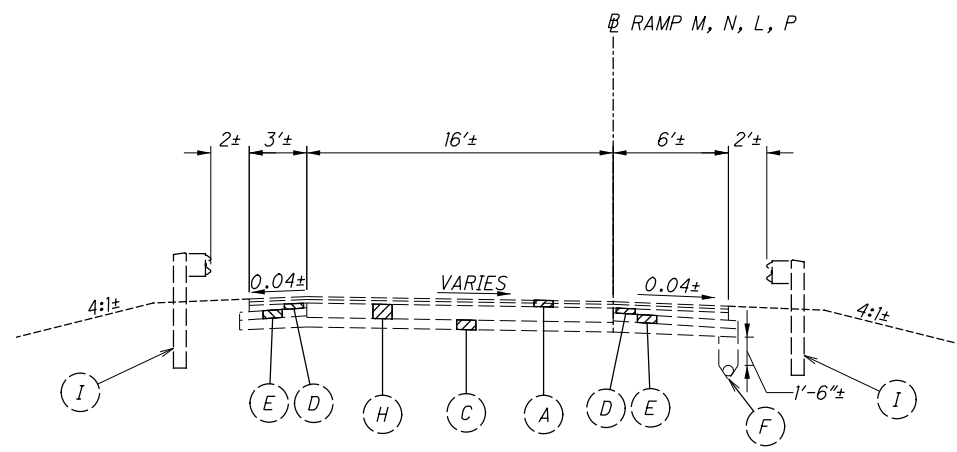

EXISTING RAMP M, N, L, & P SECTION

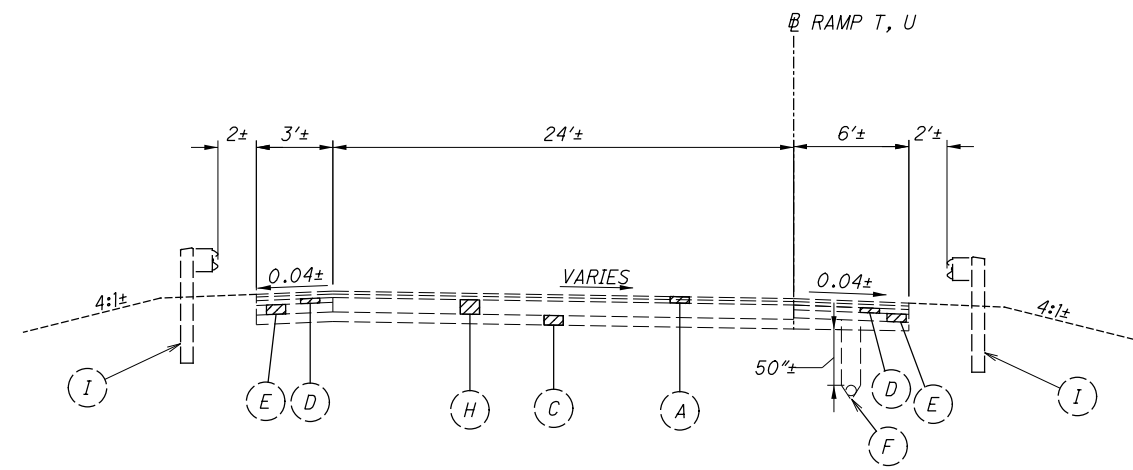

EXISTING RAMP T & U SECTION

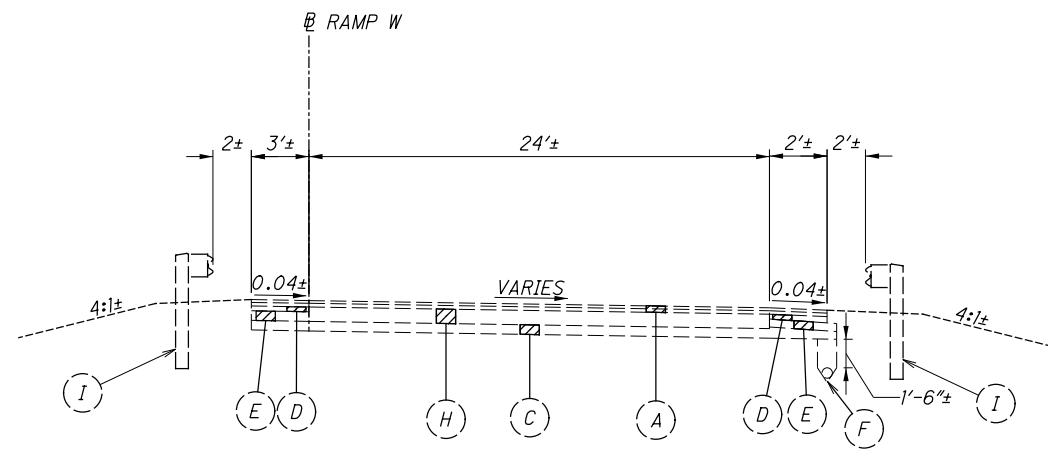

EXISTING RAMP W SECTION

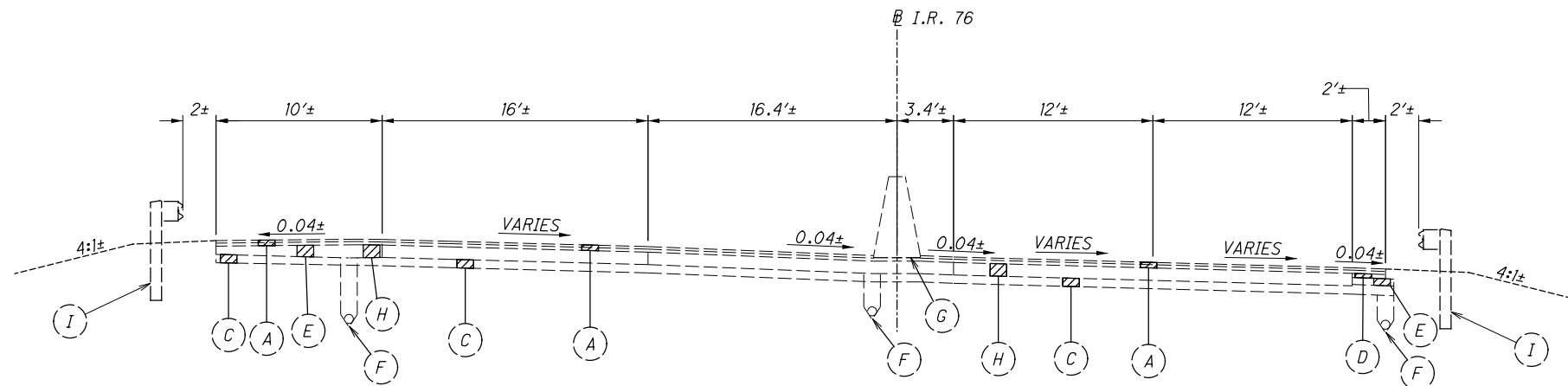

EXISTING RAMP I.R. 76 SECTION

* FOR LEGEND, SEE SHEET 16

EXISTING TYPICAL SECTIONS - I.R. 76 / I.R. 77

SUM-76 / 77 / 8-
8.24 / 9.74 / 0.00

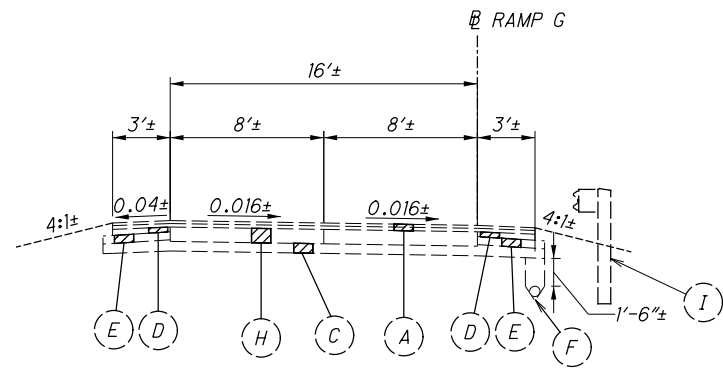

EXISTING RAMP G SECTION

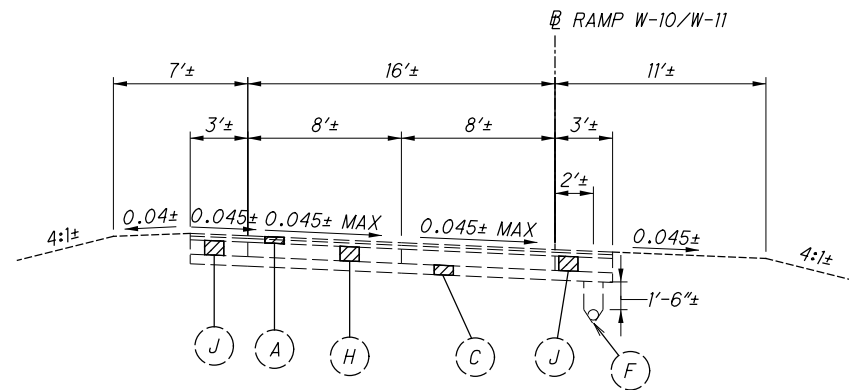

EXISTING RAMP W-10 & W-11 SECTION

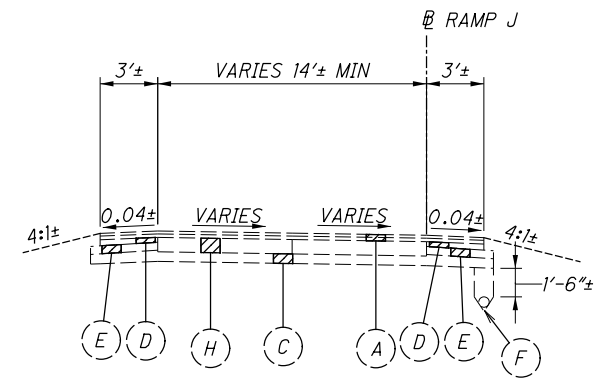

EXISTING RAMP J SECTION

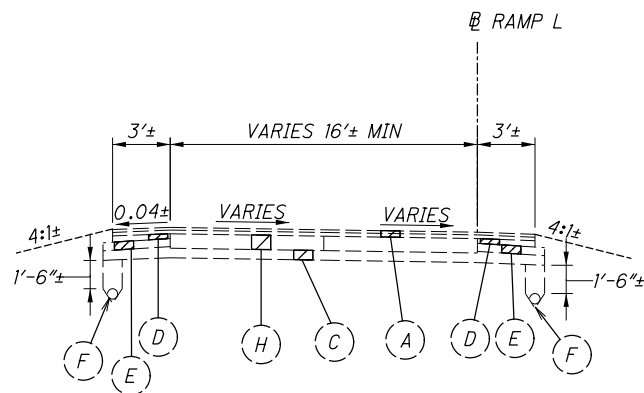

EXISTING RAMP L SECTION

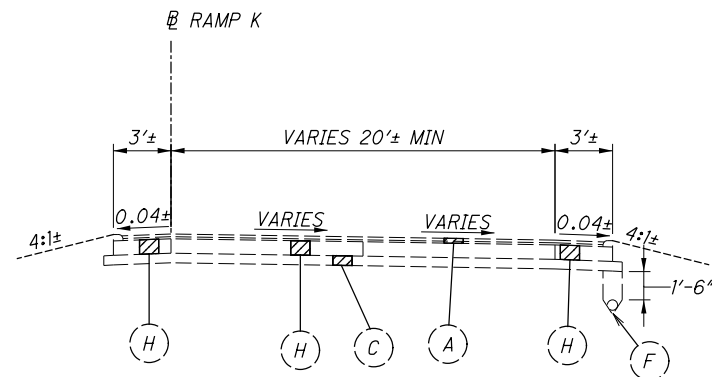

EXISTING RAMP K SECTION

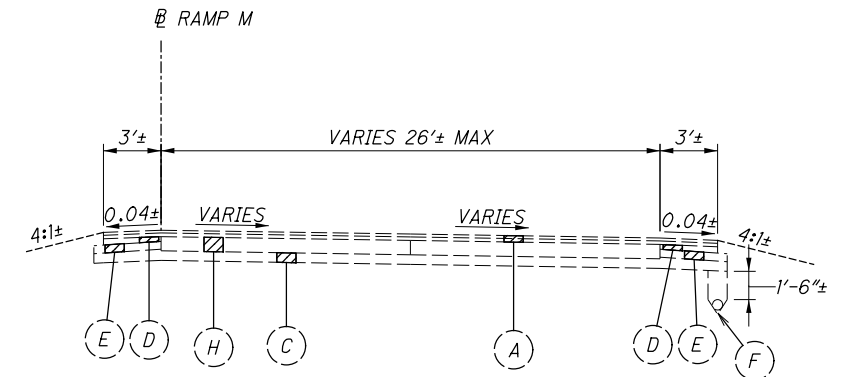

EXISTING RAMP M SECTION

P:\02329_SUM-76_77\Design\Roadway\Sheets\02329.dgn Sheet 12/15/2020 10:58:40 AM mlufes

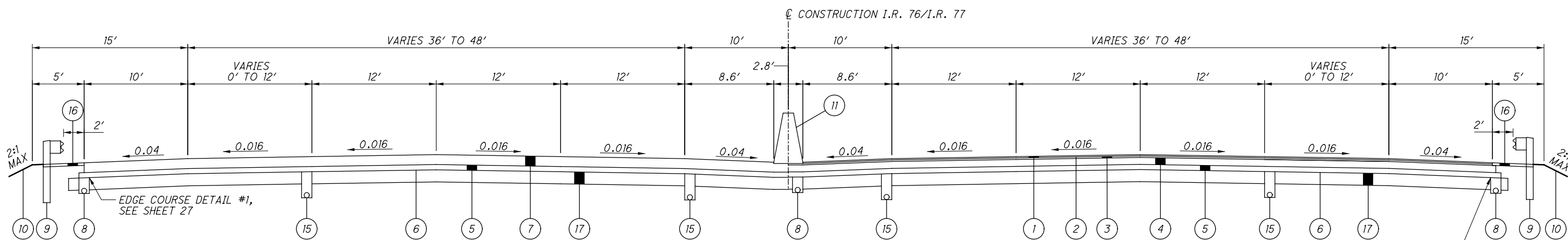

PROPOSED NORMAL SECTION - I.R. 76/I.R. 77

- A 2' - SUM-77-15.18 TO SUM-77-15.87
- B 4.6' - SUM-77-15.18 TO SUM-77-15.87
- C 6' - SUM-77-15.18 TO SUM-77-15.87

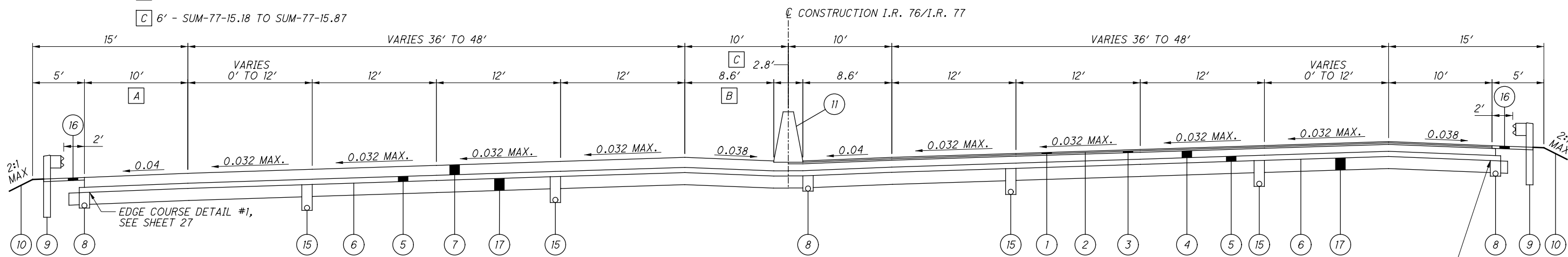

PROPOSED SUPERELEVATED LEFT SECTION - I.R. 76/I.R. 77

- NOTES:**
1. TYPICAL SECTIONS SHOW PROPOSED RIGID PAVEMENT BUILD-UP LEFT OF THE CENTERLINE AND PROPOSED FLEXIBLE PAVEMENT BUILD-UP RIGHT OF THE CENTERLINE.

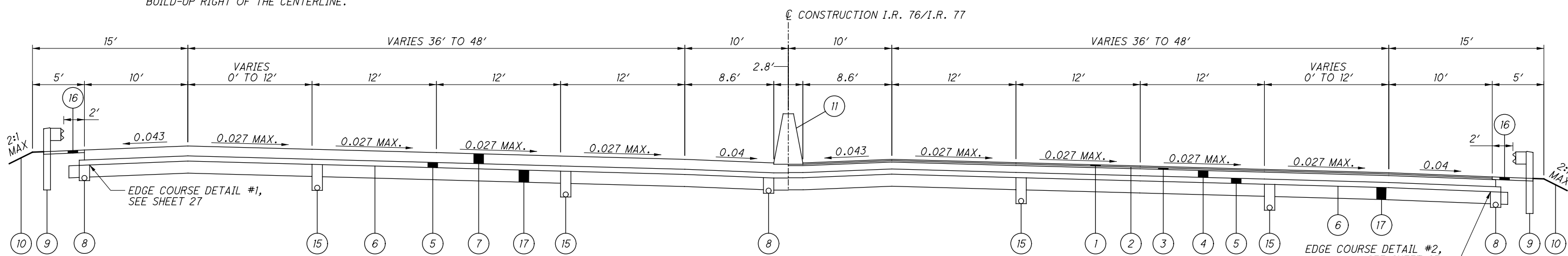

PROPOSED SUPERELEVATED RIGHT SECTION - I.R. 76/I.R. 77

PROPOSED LEGEND (SUM-76-8.24) (SUM-77-15.18)

- | | | | |
|--|---|--|--|
| <ul style="list-style-type: none"> 1 ITEM 442 - 1.5" ASPHALT CONCRETE SURFACE COURSE, 12.5 MM, TYPE A (447), AS PER PLAN 2 ITEM 407 - NON-TRACKING TACK COAT 3 ITEM 442 - 1.75" ASPHALT CONCRETE INTERMEDIATE COURSE, 19 MM, TYPE A (446), AS PER PLAN 4 ITEM 302 - 8" ASPHALT CONCRETE BASE, PG64-22 5 ITEM 304 - 6" AGGREGATE BASE, AS PER PLAN | <ul style="list-style-type: none"> 6 ITEM 204 - PROOF ROLLING 7 ITEM 452 - 12.5" NON-REINFORCED CONCRETE PAVEMENT, CLASS QC1 WITH QC/QA 8 ITEM 605 - 6" BASE PIPE UNDERDRAIN WITH GEOTEXTILE FABRIC, 18" 9 ITEM 606 - GUARDRAIL, TYPE MGS 10 ITEM 659 - SEEDING AND MULCHING | <ul style="list-style-type: none"> 11 ITEM 622 - CONCRETE BARRIER, SINGLE SLOPE, TYPE B1 OR C1 12 ITEM 254 - PAVEMENT PLANING, ASPHALT CONCRETE (T=1.5") 13 ITEM 609 - CURB, TYPE 4-A 14 ITEM 609 - CURB, TYPE 4-C 15 ITEM 605 - 6" SHALLOW PIPE UNDERDRAIN WITH GEOTEXTILE FABRIC, 30" | <ul style="list-style-type: none"> 16 ITEM 441 - ASPHALT CONCRETE INTERMEDIATE COURSE, TYPE 1, (448), (UNDER GUARDRAIL) 17 ITEM 206 - CEMENT STABILIZED SUBGRADE, 14 INCHES DEEP 18 ITEM 442 - 1.5" ASPHALT CONCRETE SURFACE COURSE, 12.5 MM, TYPE A (446), AS PER PLAN |
|--|---|--|--|

PROPOSED TYPICAL SECTIONS - I.R. 76/I.R. 77

SUM-76/77/8-8.24/9.74/0.00

P:\02329_SUM-76_77\Design\Roadway\Sheets\02329_GY104.dgn Sheet 12/14/2020 8:51:09 AM mlutes

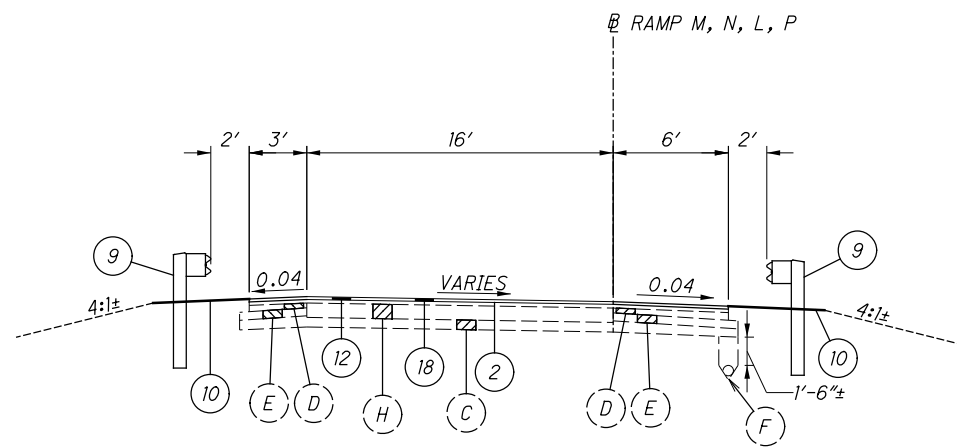

PROPOSED RAMP M, N, L, & P RESURFACING SECTION

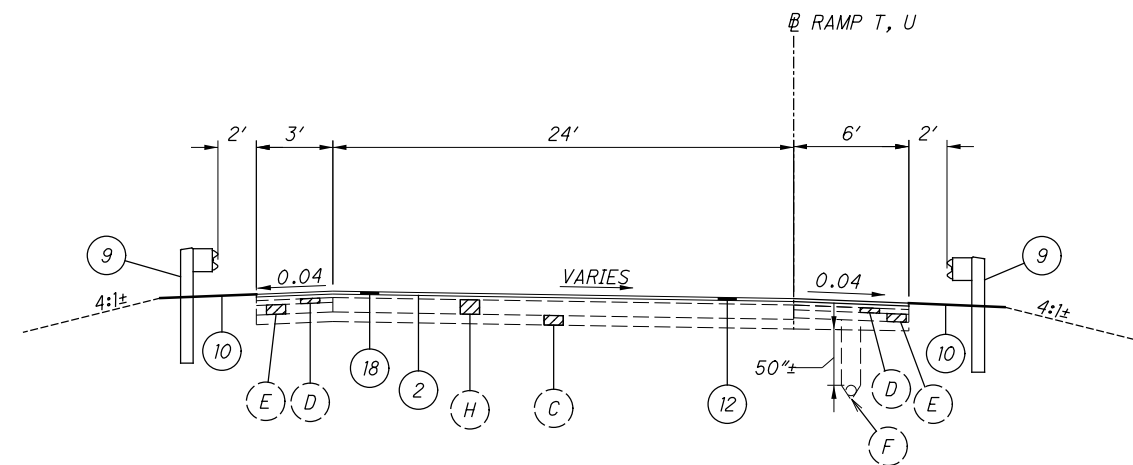

PROPOSED RAMP T & U RESURFACING SECTION

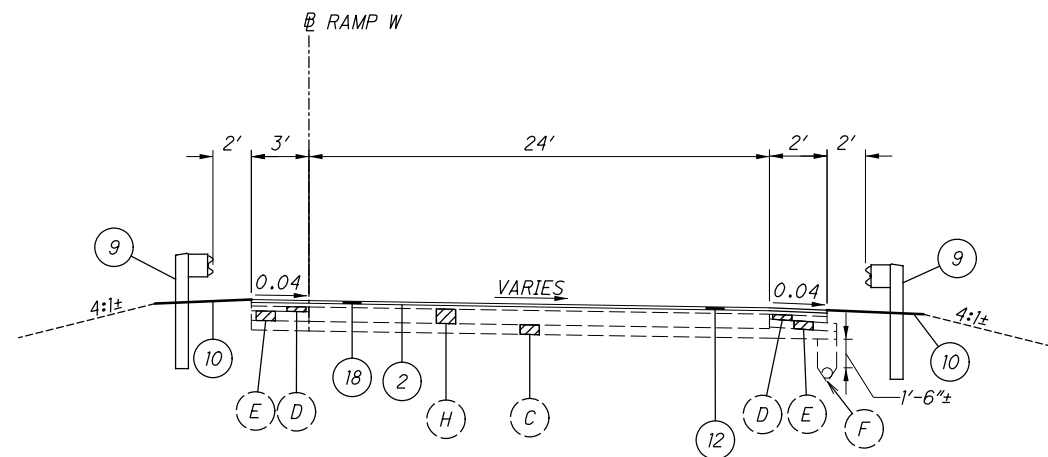

PROPOSED RAMP W RESURFACING SECTION

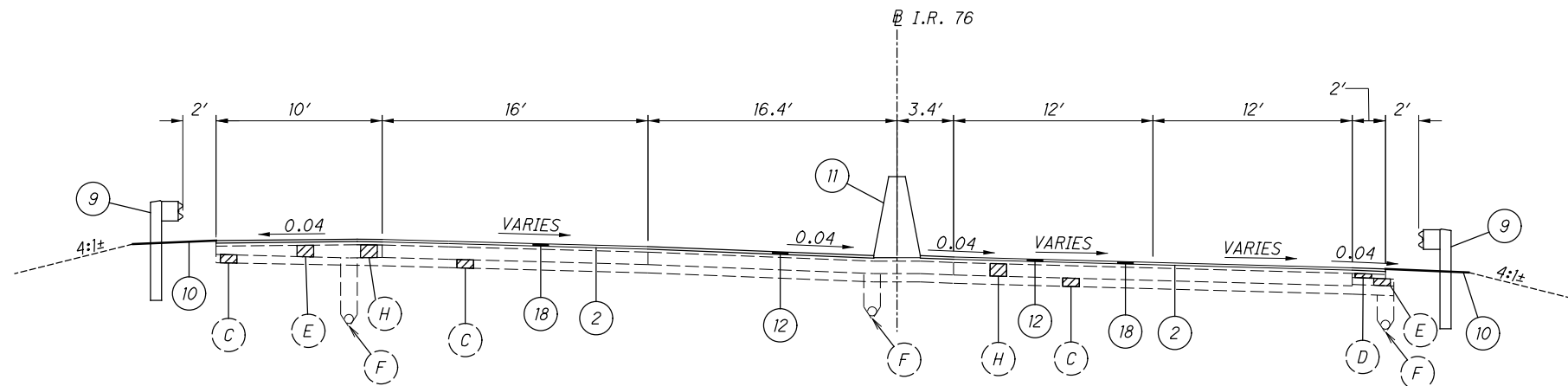

PROPOSED I.R. 76 RESURFACING SECTION

* FOR LEGEND, SEE SHEET 19

PROPOSED TYPICAL SECTIONS - I.R. 76 / I.R. 77

**SUM-76 / 77 / 8-
8.24 / 9.74 / 0.00**

20
138

P:\02329_SUM-76_77\Design\Roadway\Sheets\02329_GY105.dgn Sheet 8/7/2020 11:30:43 AM mlufes

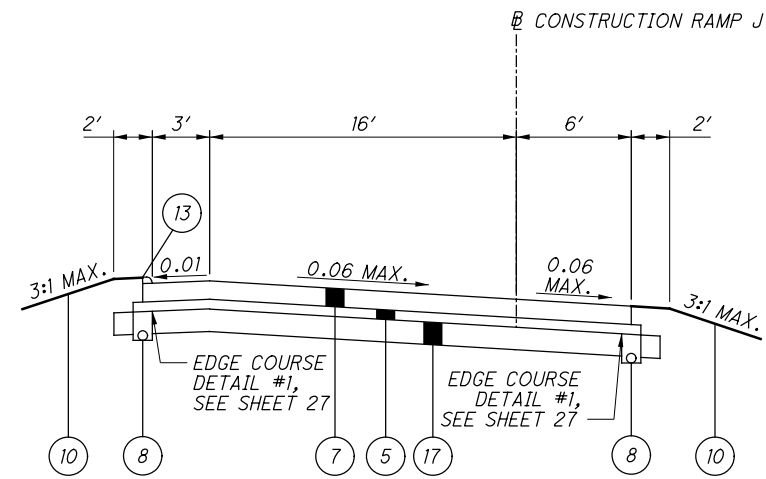

PROPOSED RAMP J SECTION

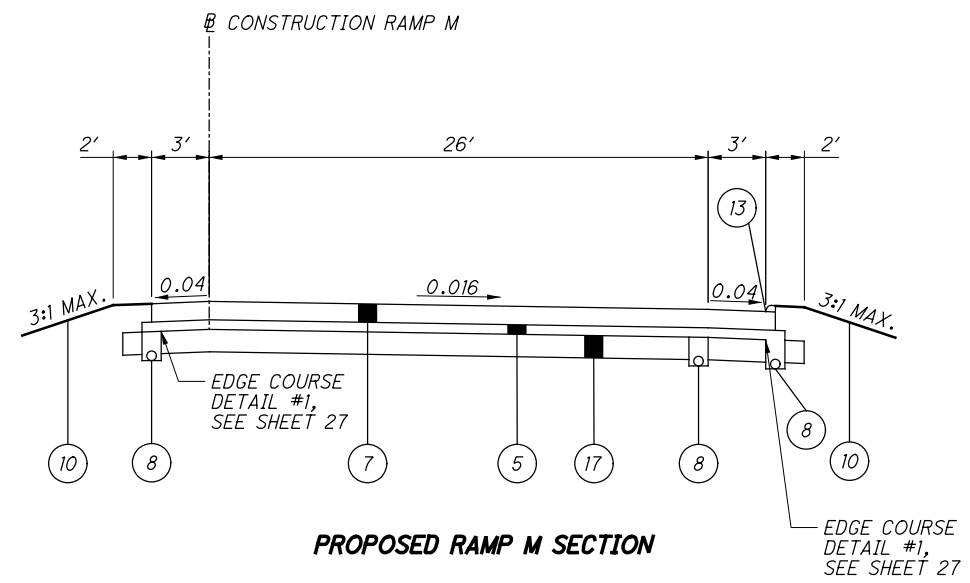

PROPOSED RAMP M SECTION

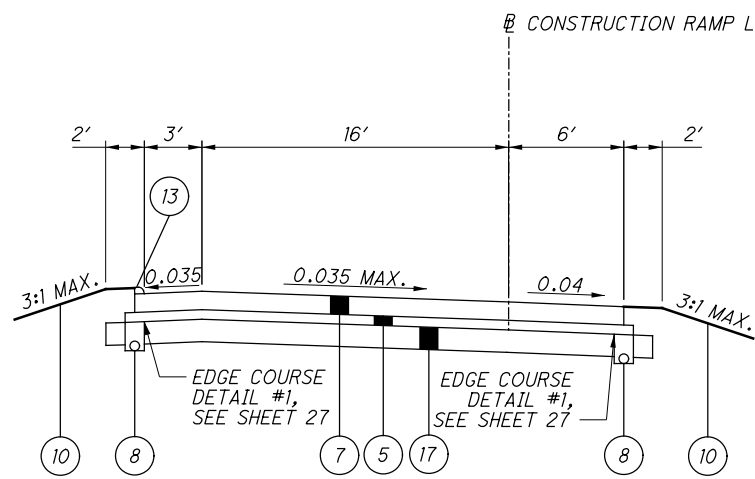

PROPOSED RAMP L SECTION

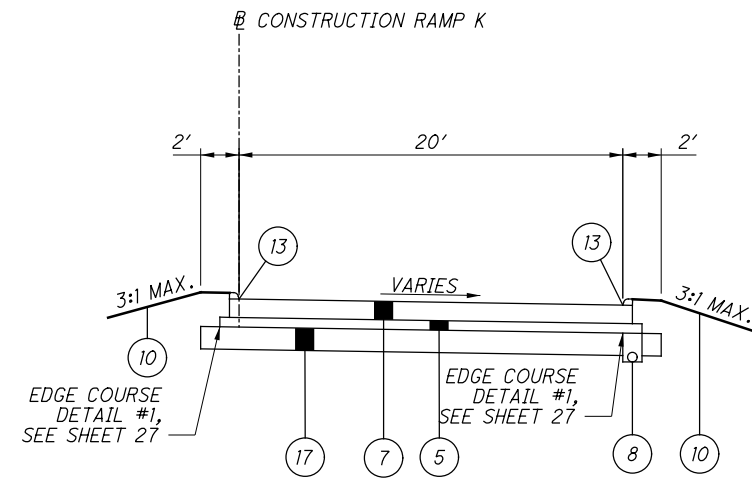

PROPOSED RAMP K SECTION

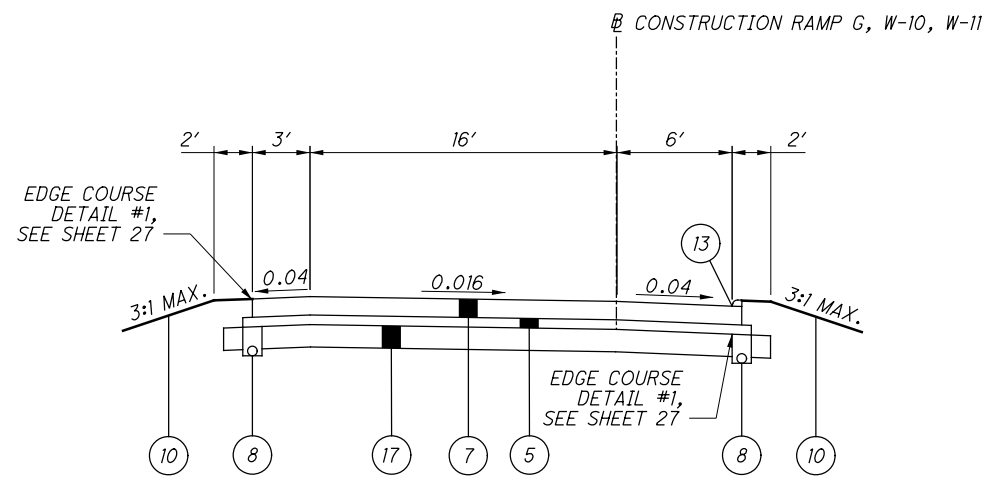

PROPOSED RAMP G, W-10, & W-11 SECTION

P:\02329_SUM-76_77\Design\Roadway\Sheets\02329_GY201.dgn Sheet 8/7/2020 11:30:45 AM mlr/tes

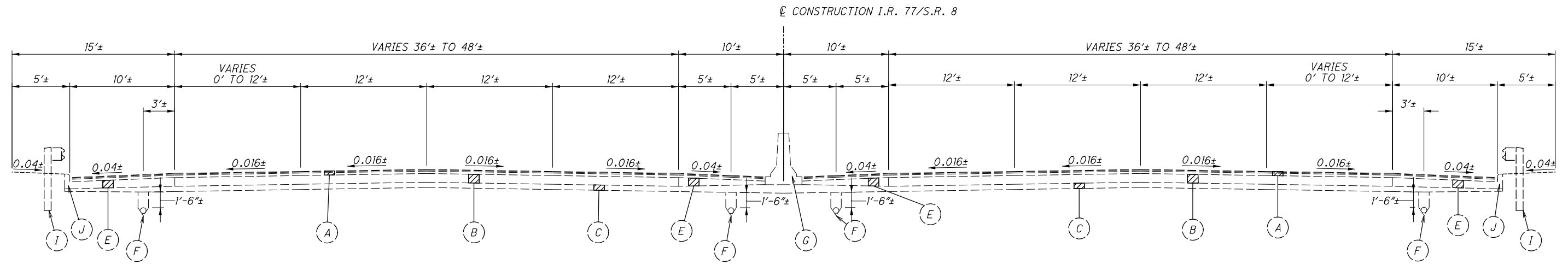

EXISTING NORMAL SECTION - I.R. 77/S.R. 8

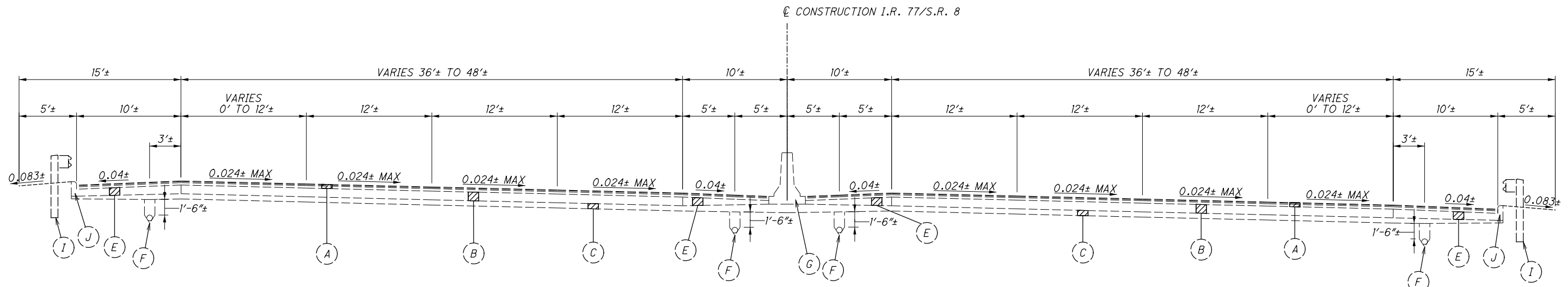

EXISTING SUPERELEVATED LEFT SECTION - I.R. 77/S.R. 8

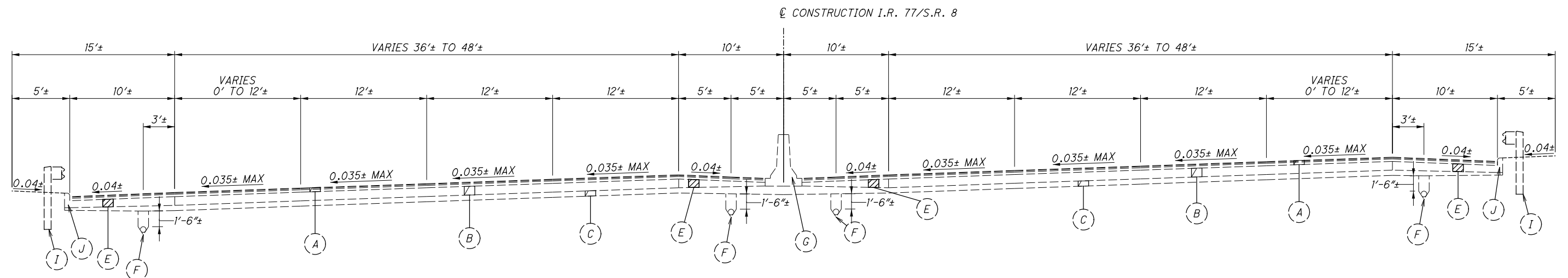

EXISTING SUPERELEVATED RIGHT SECTION - I.R. 77/S.R. 8

EXISTING LEGEND (SUM-77-9.74) (SUM-8-0.00)

- | | |
|---|--|
| (A) EX. VARIES 4"±-5"± ASPHALT CONCRETE | (F) EX. UNDERDRAIN |
| (B) EX. 10"± REINFORCED CONCRETE PAVEMENT | (G) EX. CONCRETE BARRIER |
| (C) EX. 6"± SUBBASE | (H) EX. 9"± REINFORCED CONCRETE PAVEMENT |
| (D) NOT USED | (I) EX. GUARDRAIL |
| (E) EX. 10"± AGGREGATE BASE | (J) EX. CONCRETE CURB |

EXISTING TYPICAL SECTIONS - I.R. 77 / S.R. 8

**SUM-76 / 77 / 8 -
8.24 / 9.74 / 0.00**

P:\02329_SUM-76_77\Design\Roadway\Sheets\02329_GY202.dgn Sheet 8/7/2020 11:30:46 AM mlutes

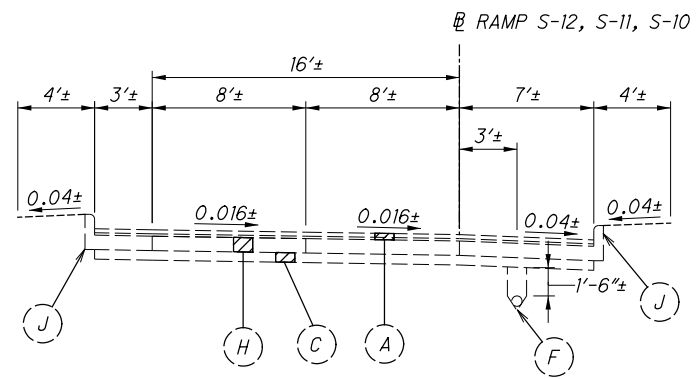

EXISTING RAMP S-12, S-11 & S-10 SECTION

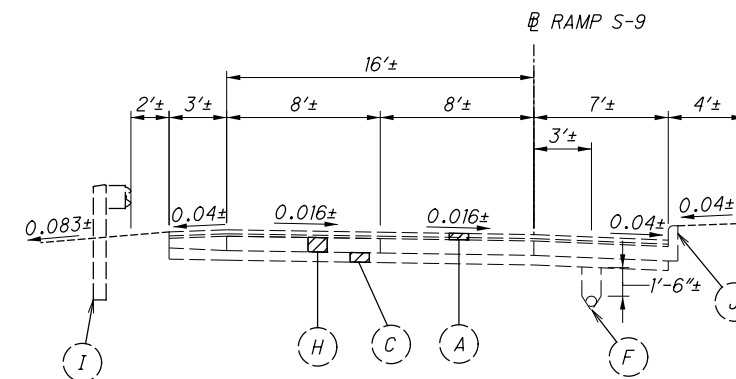

EXISTING RAMP S-9 SECTION

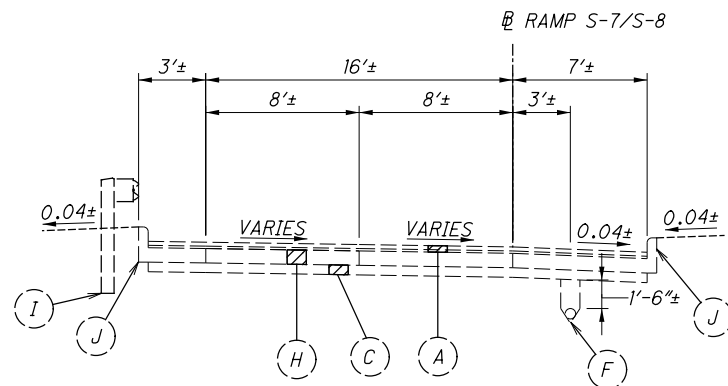

EXISTING RAMP S-7 & S-8 SECTION

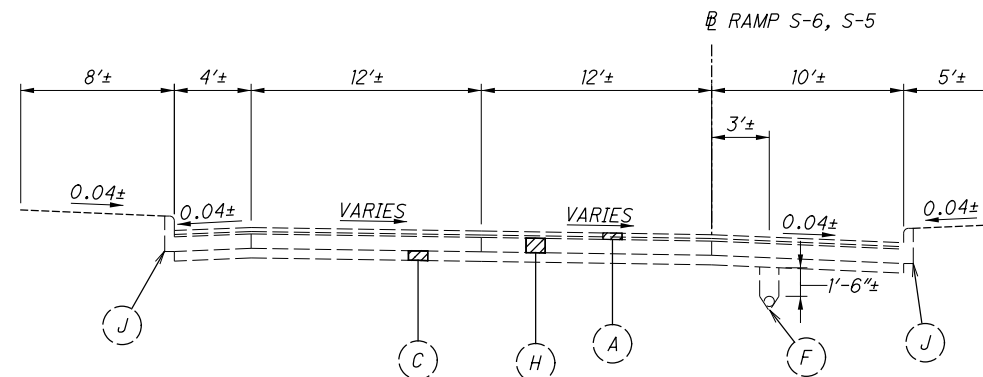

EXISTING RAMP S-6 & S-5 SECTION

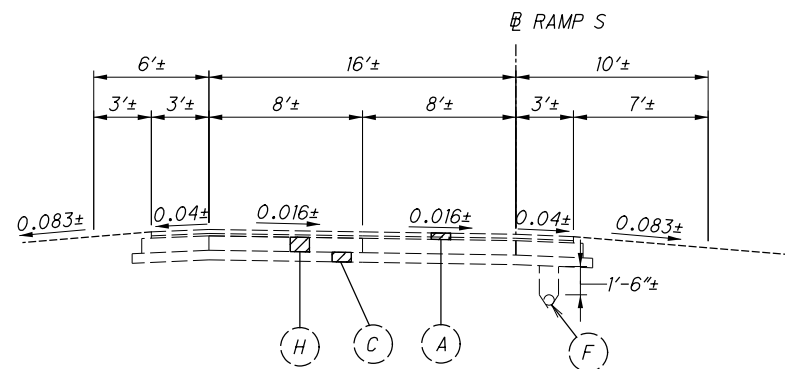

EXISTING RAMP S SECTION

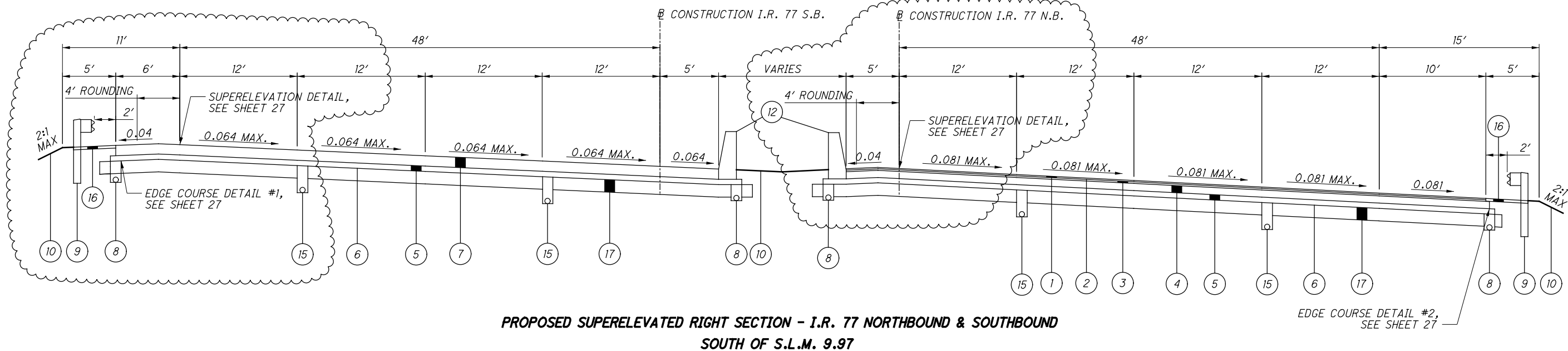

□ 11.0' FROM BEGINNING OF S.R. 8 TO NORTHERN LIMITS

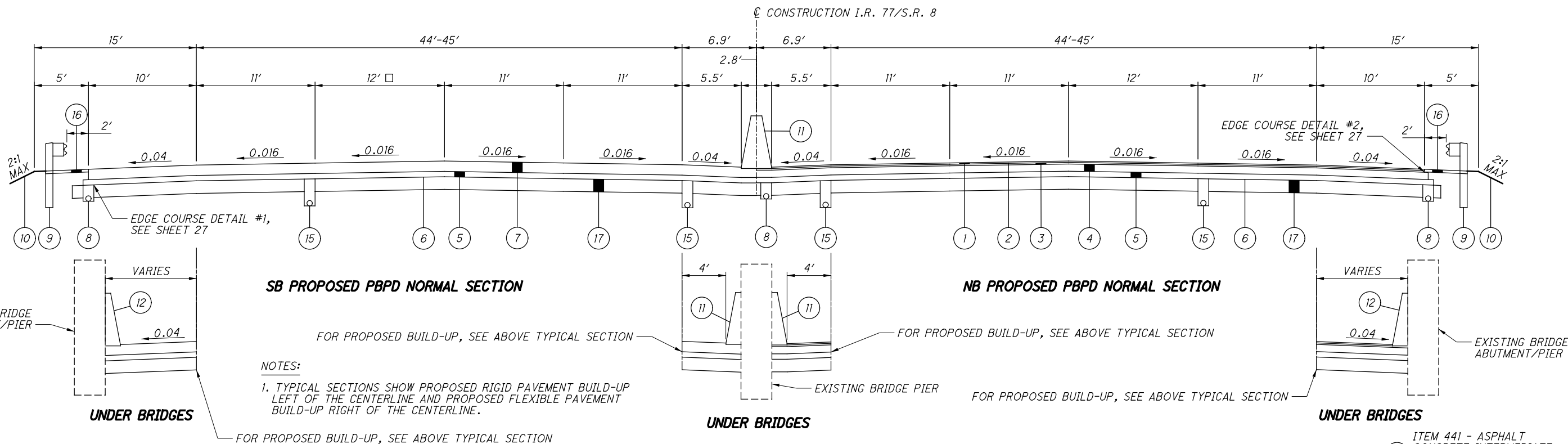

NOTES:
 1. TYPICAL SECTIONS SHOW PROPOSED RIGID PAVEMENT BUILD-UP LEFT OF THE CENTERLINE AND PROPOSED FLEXIBLE PAVEMENT BUILD-UP RIGHT OF THE CENTERLINE.

PROPOSED LEGEND (SUM-77-9.74) (SUM-8-0.00)

- | | | | |
|--|--|--|--|
| <ul style="list-style-type: none"> ① ITEM 442 - 1.5" ASPHALT CONCRETE SURFACE COURSE, 12.5 MM, TYPE A (447), AS PER PLAN ② ITEM 407 - NON-TRACKING TACK COAT ③ ITEM 442 - 1.75" ASPHALT CONCRETE INTERMEDIATE COURSE, 19 MM, TYPE A (446), AS PER PLAN ④ ITEM 302 - 8" ASPHALT CONCRETE BASE, PG64-22 ⑤ ITEM 304 - 6" AGGREGATE BASE, AS PER PLAN | <ul style="list-style-type: none"> ⑥ ITEM 204 - PROOF ROLLING ⑦ ITEM 452 - 12.5" NON-REINFORCED CONCRETE PAVEMENT, CLASS QC1 WITH QC/QA ⑧ ITEM 605 - 6" BASE PIPE UNDERDRAIN WITH GEOTEXTILE FABRIC, 18" ⑨ ITEM 606 - GUARDRAIL, TYPE MGS ⑩ ITEM 659 - SEEDING AND MULCHING | <ul style="list-style-type: none"> ⑪ ITEM 622 - CONCRETE BARRIER, SINGLE SLOPE, TYPE B1 OR C1 ⑫ ITEM 622 - CONCRETE BARRIER, SINGLE SLOPE, TYPE D ⑬ ITEM 609 - CURB, TYPE 4-A ⑭ ITEM 609 - CURB, TYPE 4-C ⑮ ITEM 605 - 6" SHALLOW PIPE UNDERDRAIN WITH GEOTEXTILE FABRIC, 30" | <ul style="list-style-type: none"> ⑯ ITEM 441 - ASPHALT CONCRETE INTERMEDIATE COURSE, TYPE 1, (448), (UNDER GUARDRAIL) ⑰ ITEM 206 - CEMENT STABILIZED SUBGRADE, 14 INCHES DEEP ⑱ ITEM 254 - PAVEMENT PLANING, ASPHALT CONCRETE (T=1.5") ⑲ ITEM 442 - 2.0" ASPHALT CONCRETE SURFACE COURSE, 12.5 MM, TYPE B (446), AS PER PLAN ⑳ ITEM 442 - 1.50" ASPHALT CONCRETE INTERMEDIATE COURSE, 19 MM, TYPE B (446), AS PER PLAN |
|--|--|--|--|

P:\102329_SUM-76_77\Design\Roadway\Sheets\102329_GY203.dgn Sheet 12/28/2020 11:07:56 AM mluttes

P:\102329_SUM-76_77\Design\Roadway\Sheets\102329_GY203A.dgn Sheet 12/28/2020 10:08:03 AM ml/tes

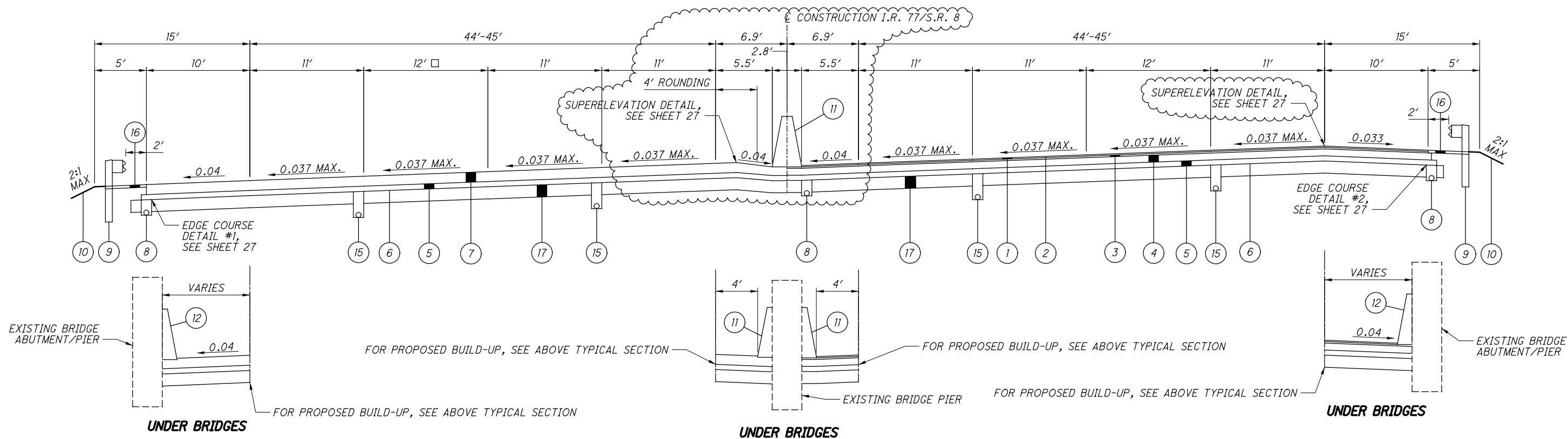

**PROPOSED SUPERELEVATED LEFT SECTION - I.R. 77/S.R. 8
NORTH OF S.L.M. 9.97**

□ 11.0' FROM BEGINNING OF S.R. 8 TO NORTHERN LIMITS

NOTES:

1. TYPICAL SECTIONS SHOW PROPOSED RIGID PAVEMENT BUILD-UP LEFT OF THE CENTERLINE AND PROPOSED FLEXIBLE PAVEMENT BUILD-UP RIGHT OF THE CENTERLINE.

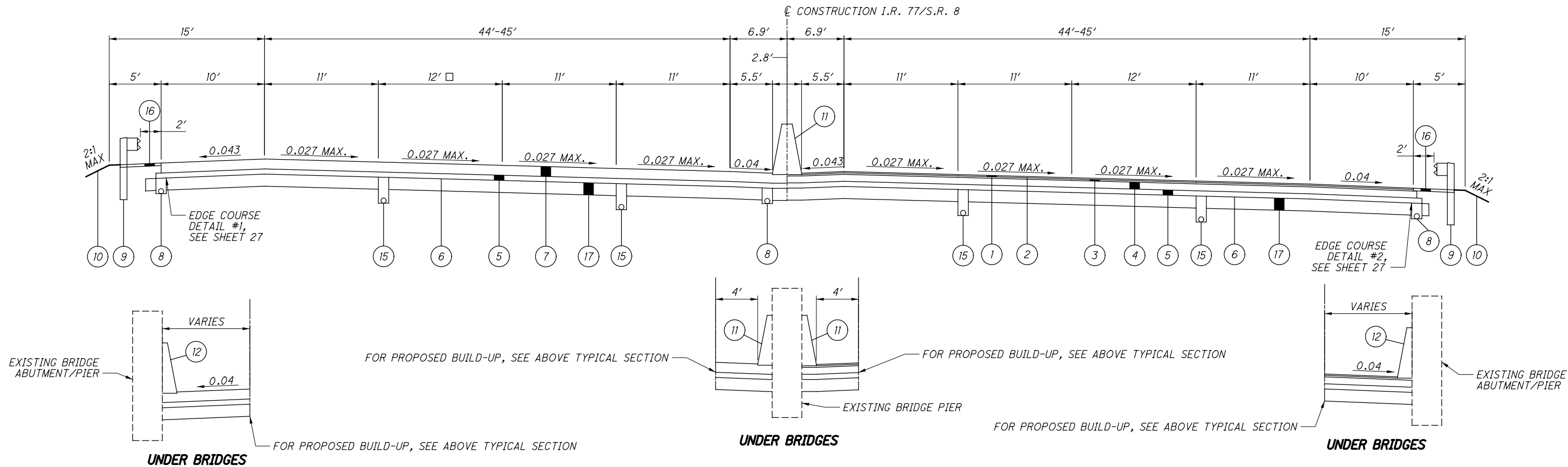

**PROPOSED SUPERELEVATED RIGHT SECTION - I.R. 77/S.R. 8
NORTH OF S.L.M. 9.97**

* FOR LEGEND, SEE SHEET 24

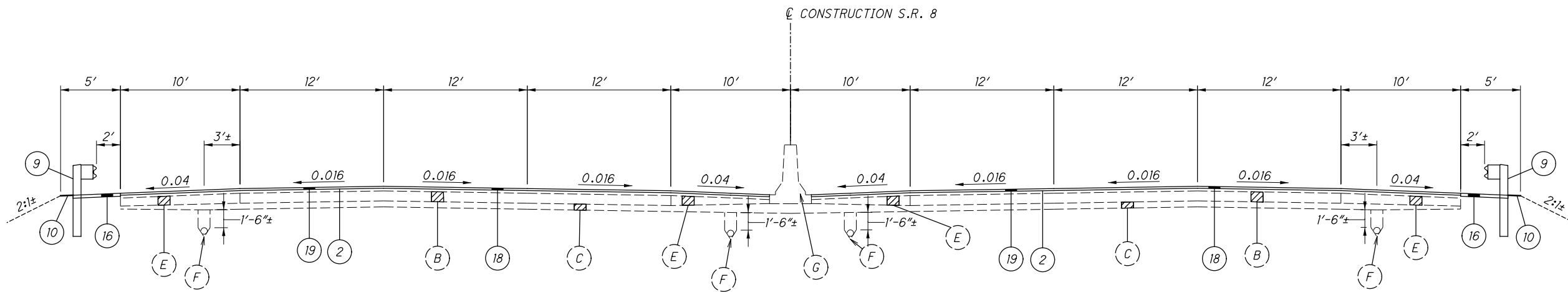

PROPOSED NORMAL SECTION - S.R. 8

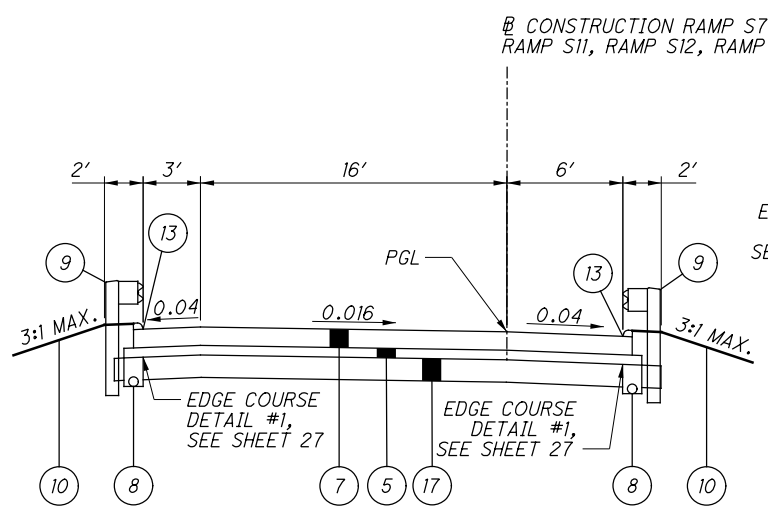

PROPOSED RAMP S7, S9, S11, S12 & T SECTION

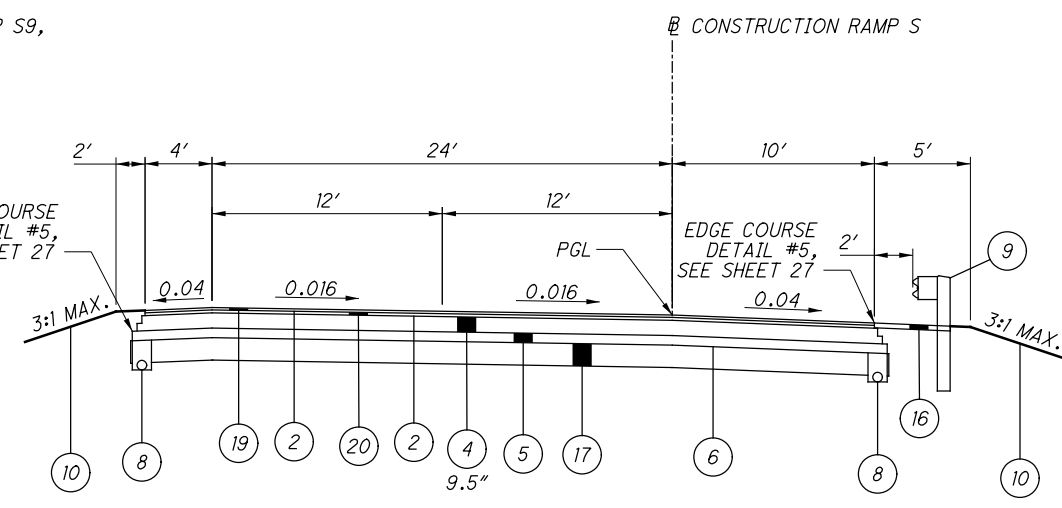

PROPOSED RAMP S SECTION

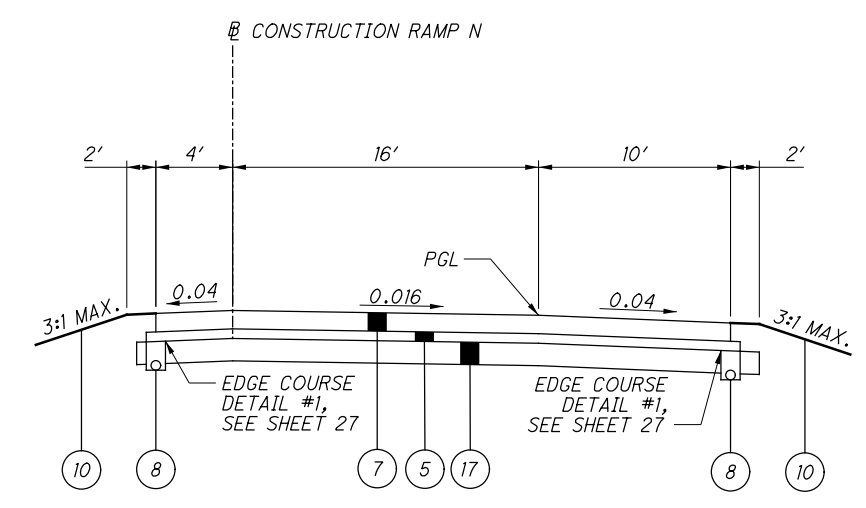

PROPOSED RAMP N SECTION

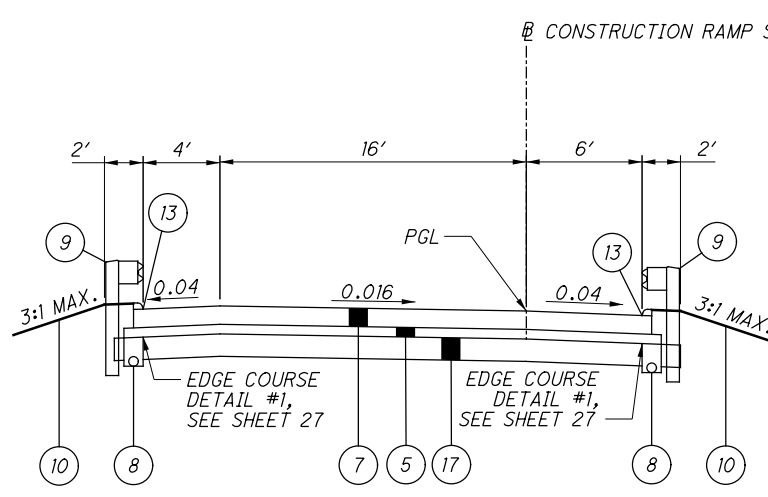

PROPOSED RAMP S5, S10, M & S SECTION

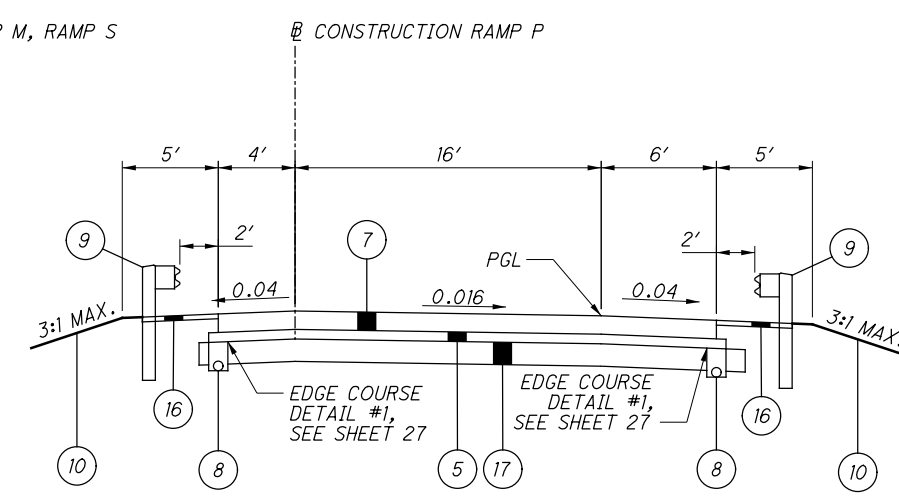

PROPOSED RAMP P SECTION

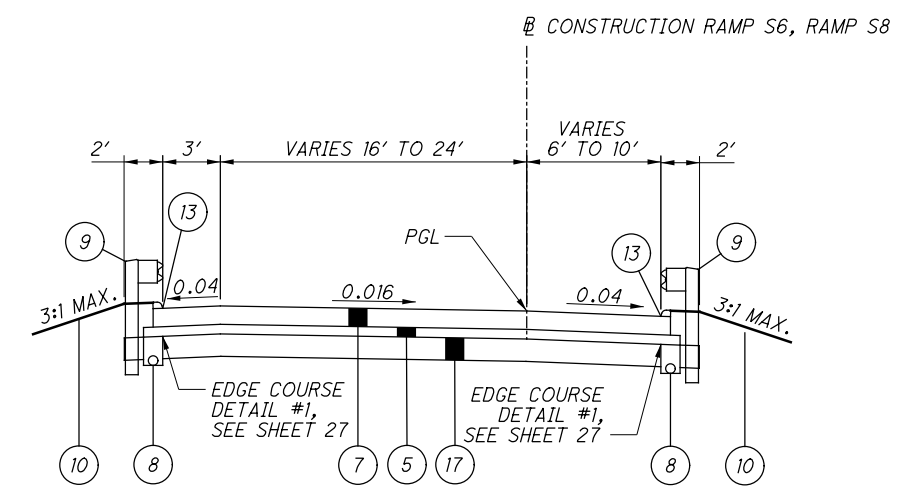

PROPOSED RAMP S6 & S8 SECTION

* FOR LEGEND, SEE SHEET 24

P:\02329_SUM-76_77\Design\Roadway\Sheets\02329_GY204.dgn Sheet 12/14/2020 8:51:21 AM mlutes

PROPOSED TYPICAL SECTIONS - I.R. 77 / S.R. 8

**SUM-76 / 77 / 8-
8.24 / 9.74 / 0.00**

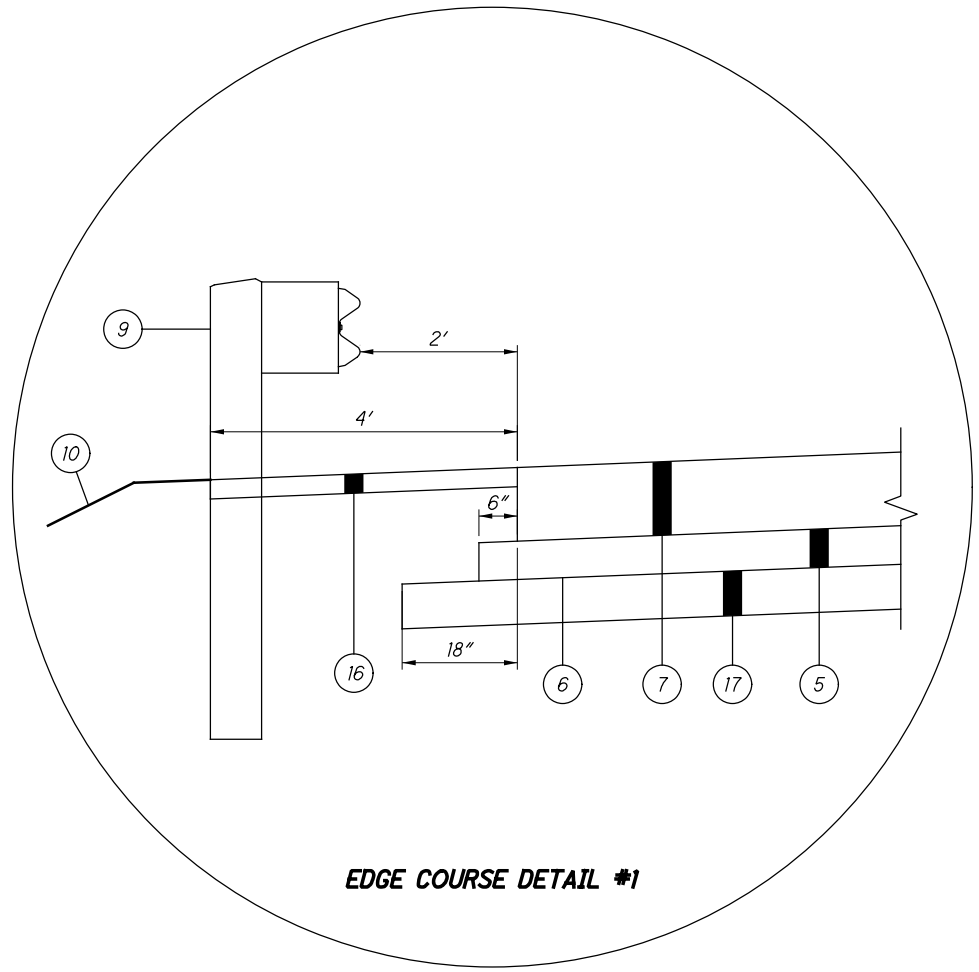

EDGE COURSE DETAIL #1

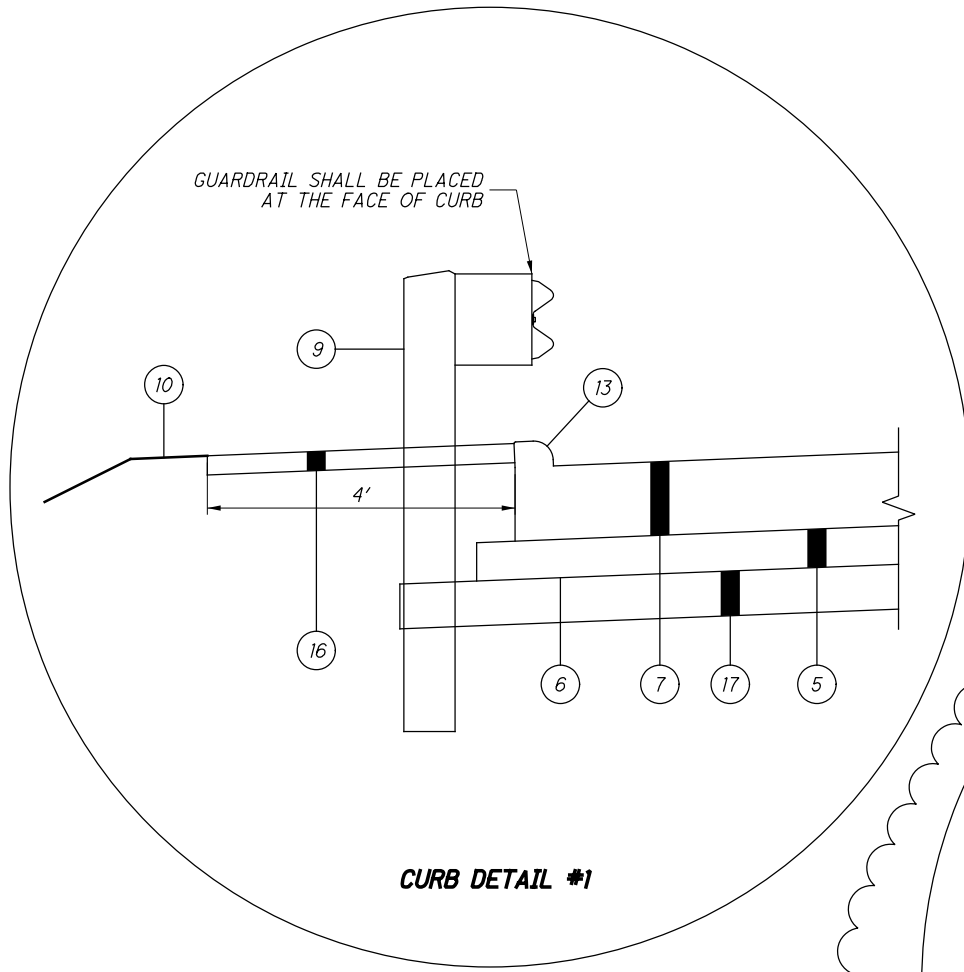

CURB DETAIL #1

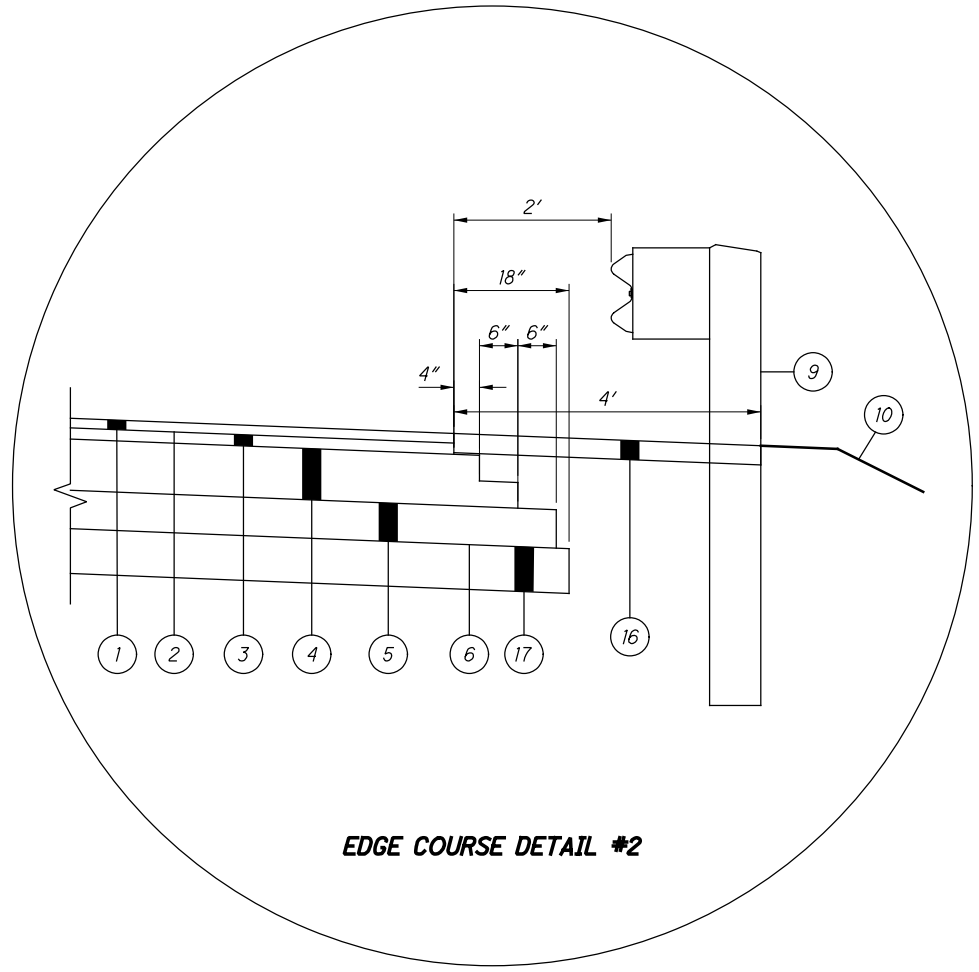

EDGE COURSE DETAIL #2

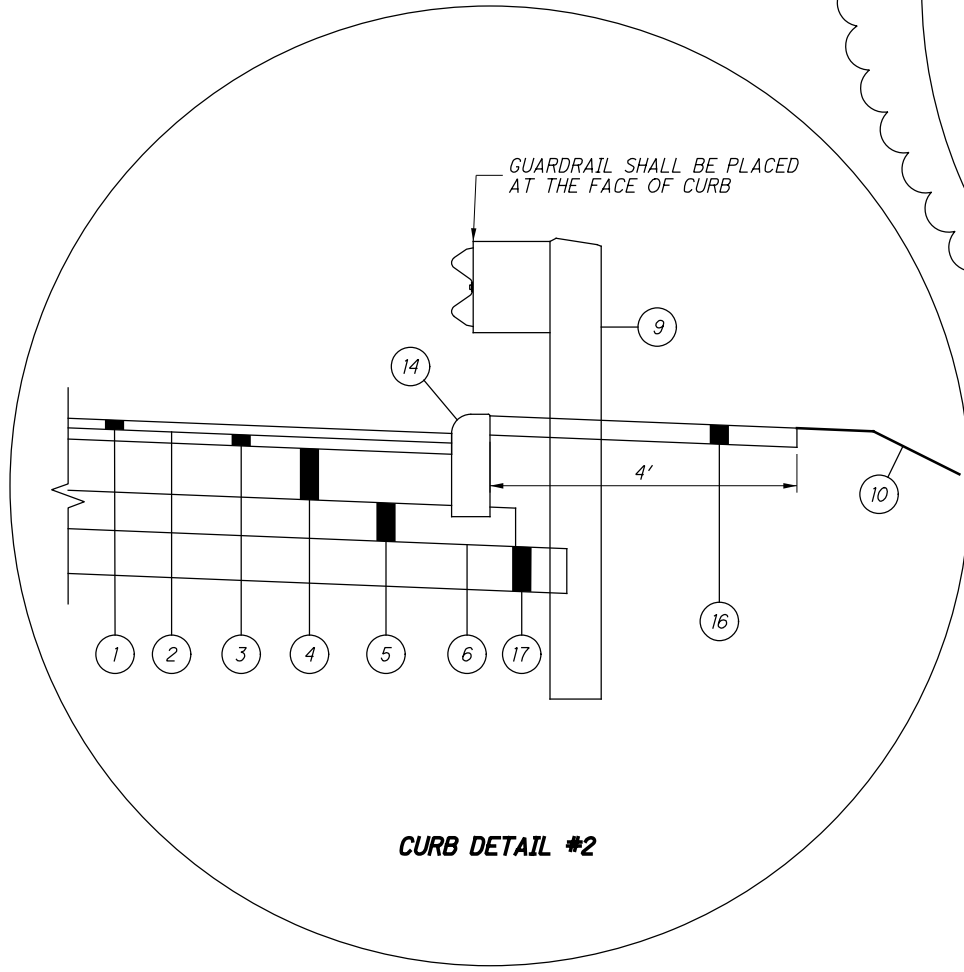

CURB DETAIL #2

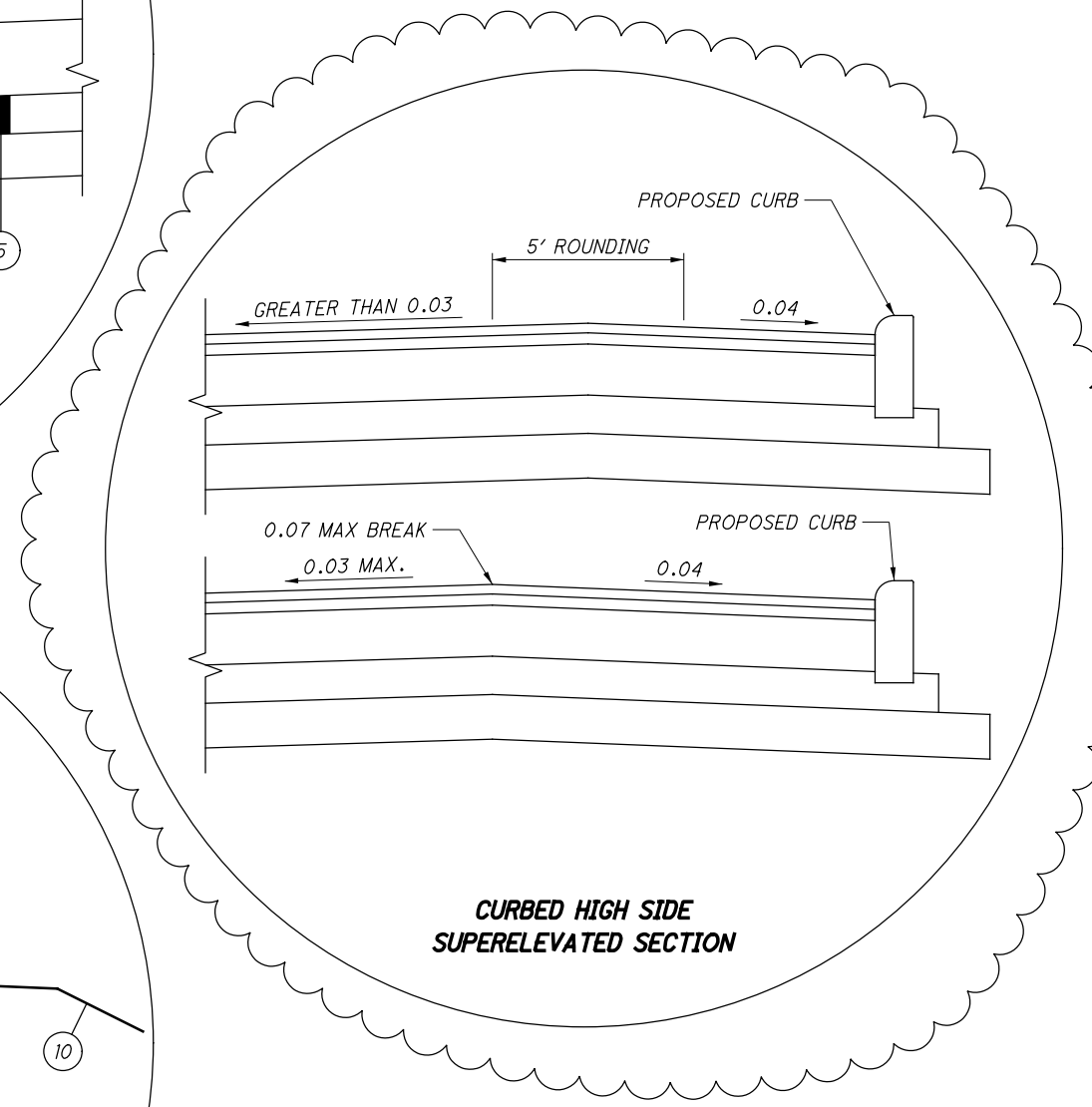

CURBED HIGH SIDE SUPERELEVATED SECTION

* FOR LEGEND, SEE SHEET 24

P:\102329_SUM-76_77\Design\Roadway\Sheets\102329_GPO01.dgn Sheet 8/7/2020 11:31:03 AM miles

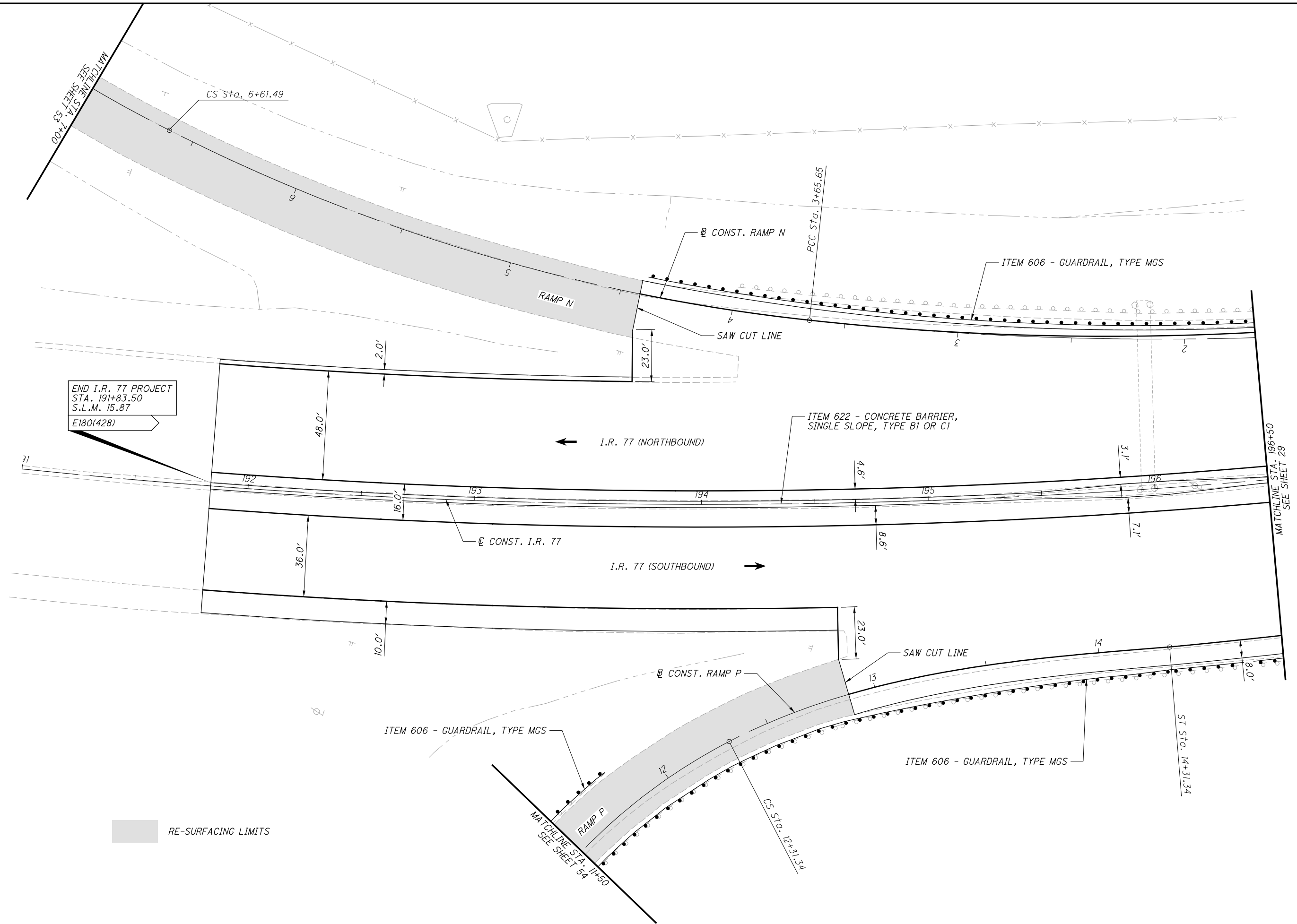

END I.R. 77 PROJECT
 STA. 191+83.50
 S.L.M. 15.87
 E180(428)

RE-SURFACING LIMITS

CALCULATED
 MLL
 CHECKED
 JTJ

0 20 40
 HORIZONTAL
 SCALE IN FEET

PLAN - I.R. 77
 END I.R. 77 PROJECT TO STA. 196+50

SUM-76 / 77 / 8-
 8.24 / 9.74 / 0.00

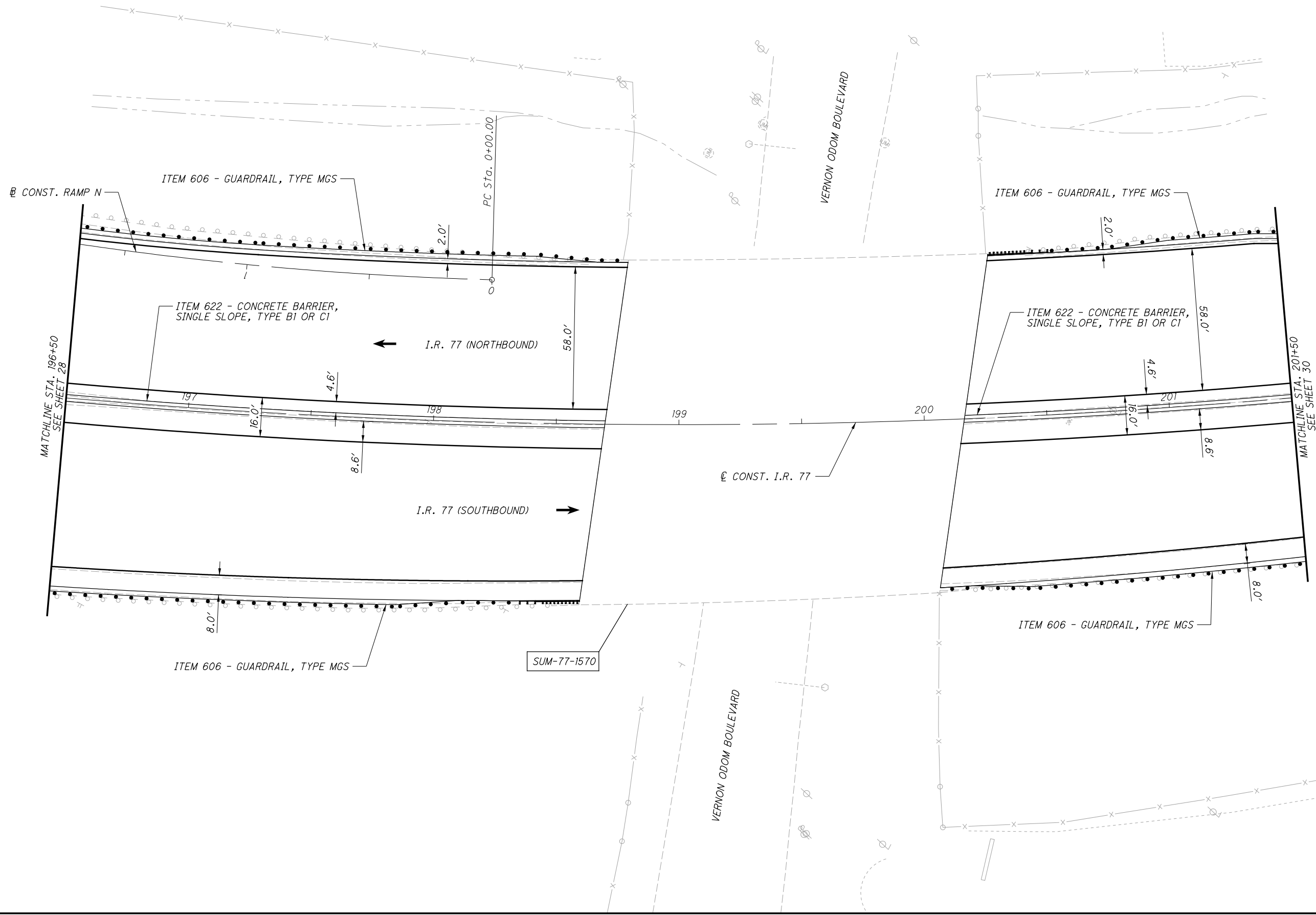

CALCULATED
MLL
CHECKED
JTW

0 20 40
HORIZONTAL
SCALE IN FEET

PLAN - I.R. 77
STA. 196+50 TO STA. 201+50

SUM-76 / 77 / 8-
8.24 / 9.74 / 0.00

29
138

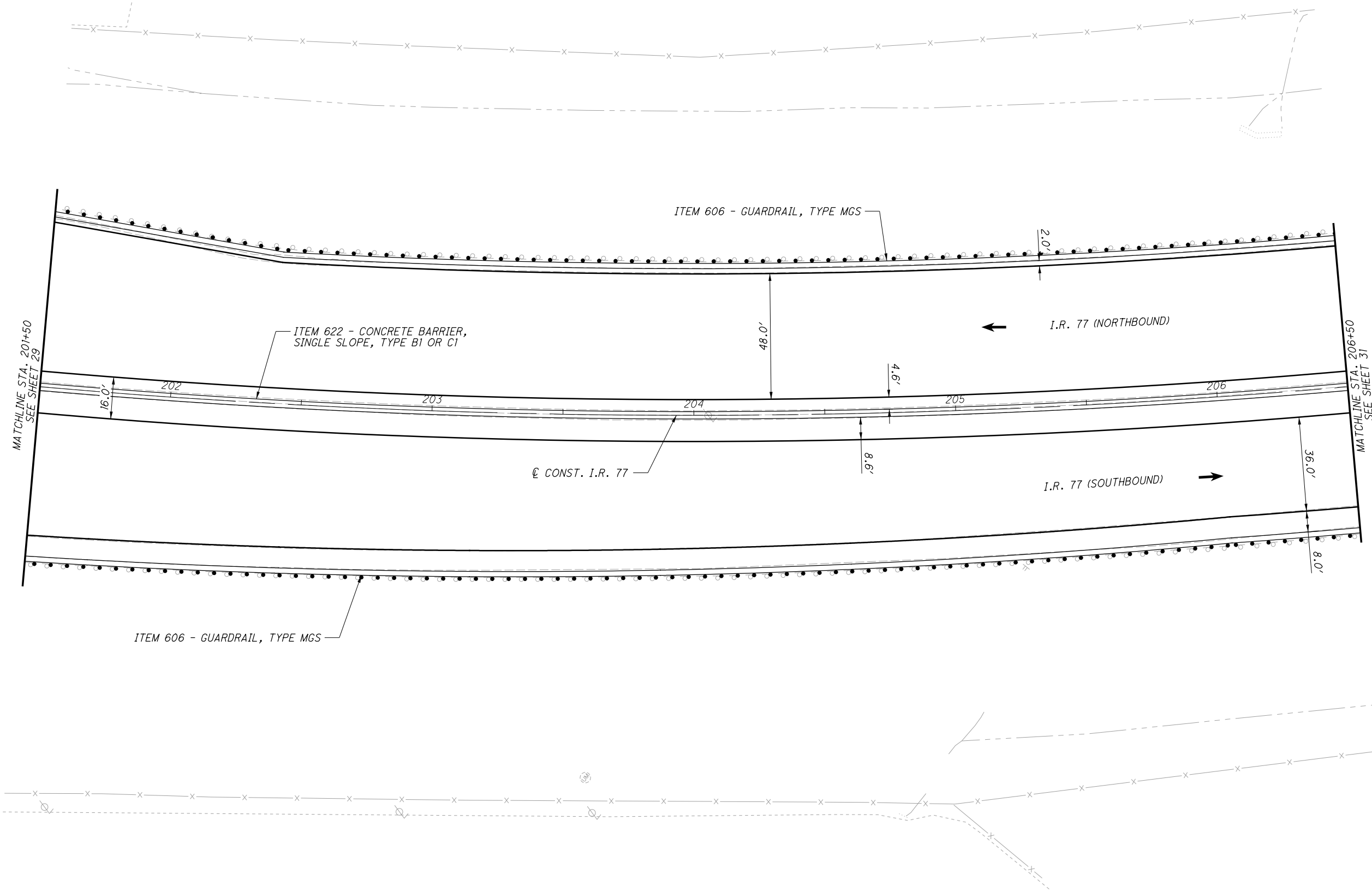

CALCULATED
MLL
CHECKED
JTW

0 20 40
HORIZONTAL
SCALE IN FEET

PLAN - I.R. 77
STA. 201+50 TO STA. 206+50

SUM-76 / 77 / 8-
8.24 / 9.74 / 0.00

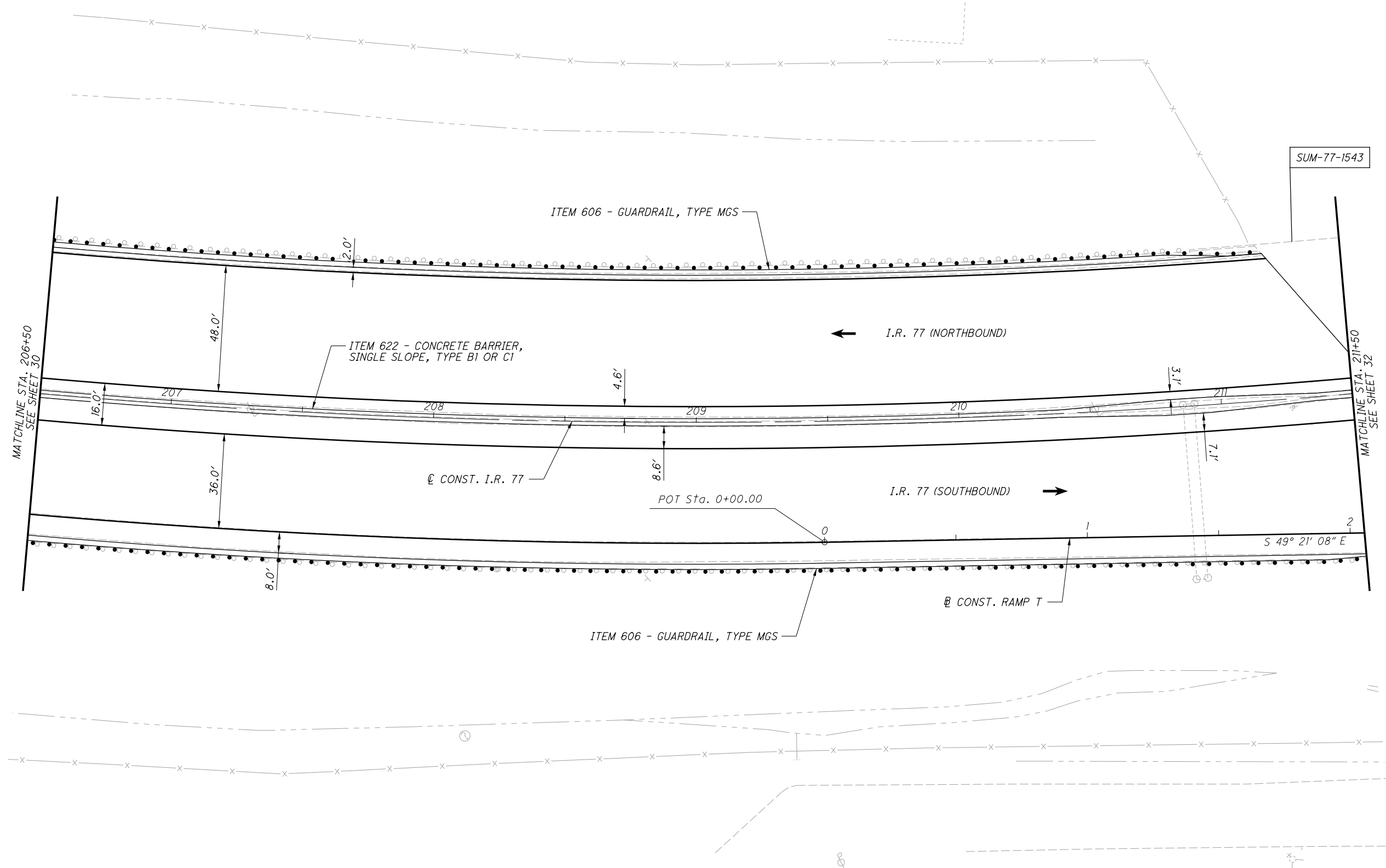

CALCULATED
M.L.L.
CHECKED
J.T.W.

0 20 40
HORIZONTAL
SCALE IN FEET

PLAN - I.R. 77
STA. 206+50 TO STA. 211+50

SUM-76 / 77 / 8-
8.24 / 9.74 / 0.00

P:\102329_SUM-76_77\Design\Roadway\Sheets\102329_GPO05.dgn Sheet 8/7/2020 11:31:07 AM mlr/tes

RE-SURFACING LIMITS

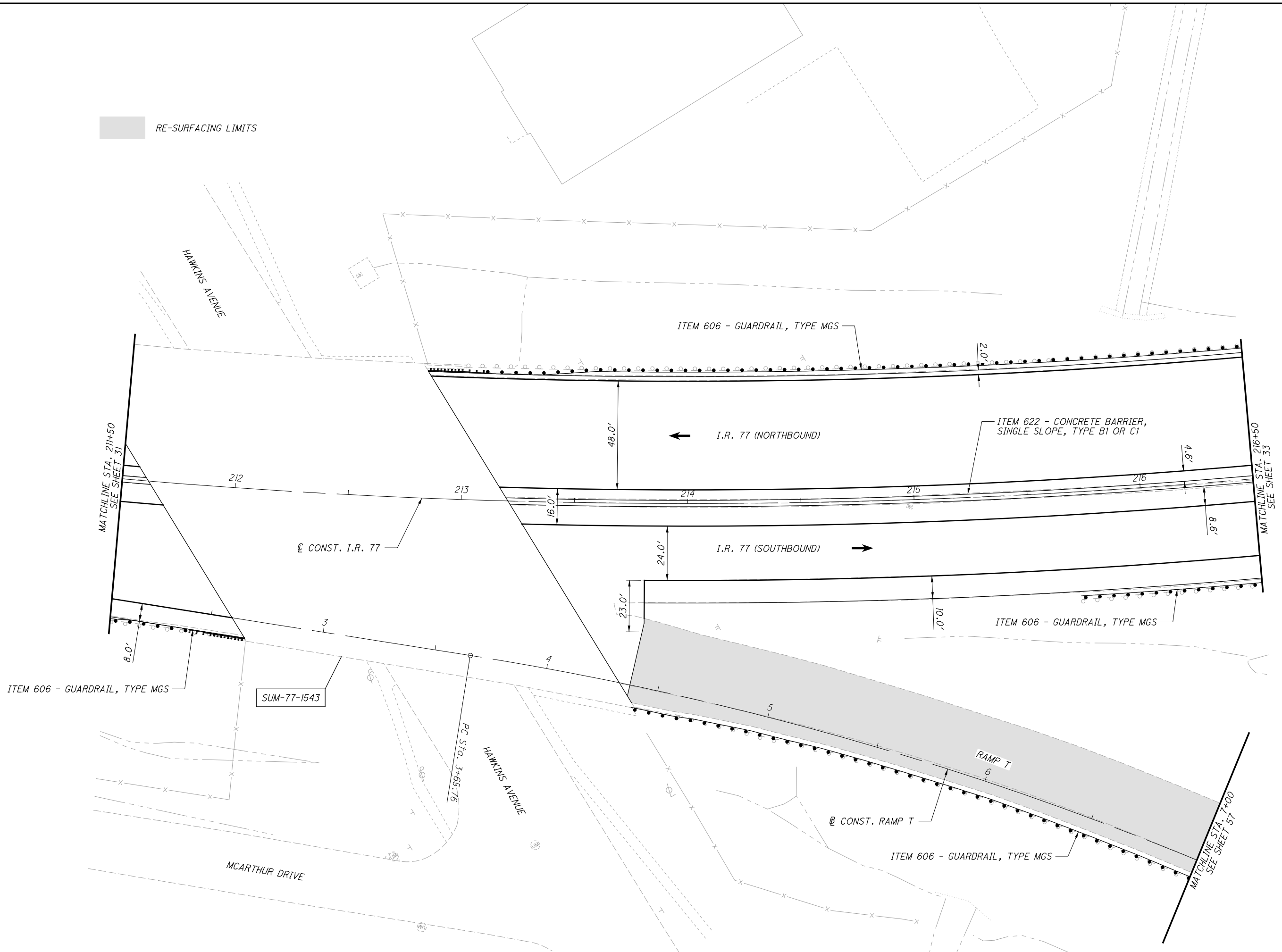

CALCULATED
M.L.L.
CHECKED
J.T.W.

0 20 40
HORIZONTAL
SCALE IN FEET

PLAN - I.R. 77
STA. 211+50 TO STA. 216+50

SUM-76 / 77 / 8-
8.24 / 9.74 / 0.00

P:\102329_SUM-76_77\Design\Roadway\Sheets\102329_GPO06.dgn Sheet 8/7/2020 11:31:09 AM mlutes

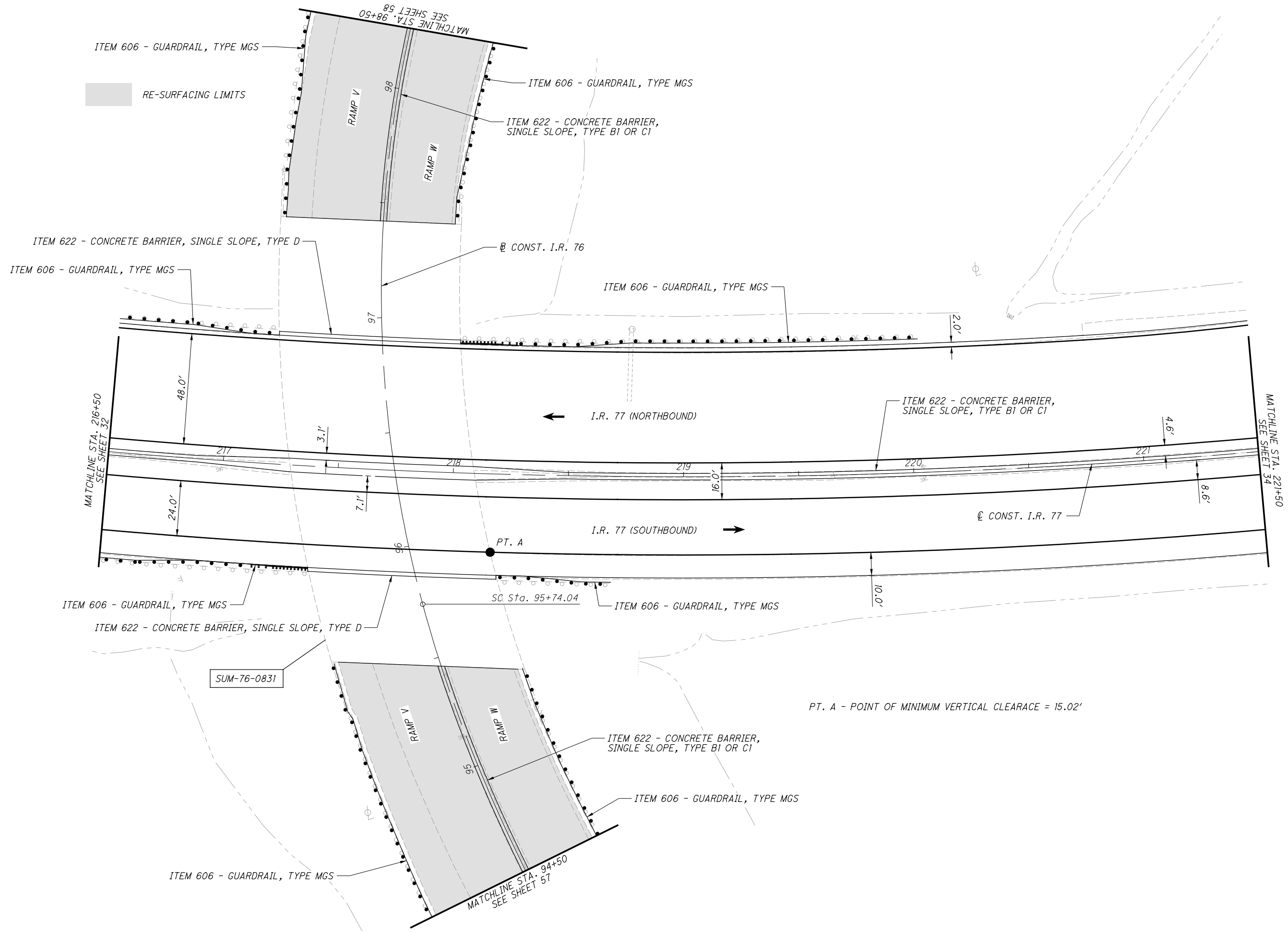

CALCULATED
MLL
CHECKED
JTW

0 20 40
HORIZONTAL SCALE IN FEET

PLAN - I.R. 77
STA. 216+50 TO STA. 221+50

SUM-76/77/8-
8.24/9.74/0.00

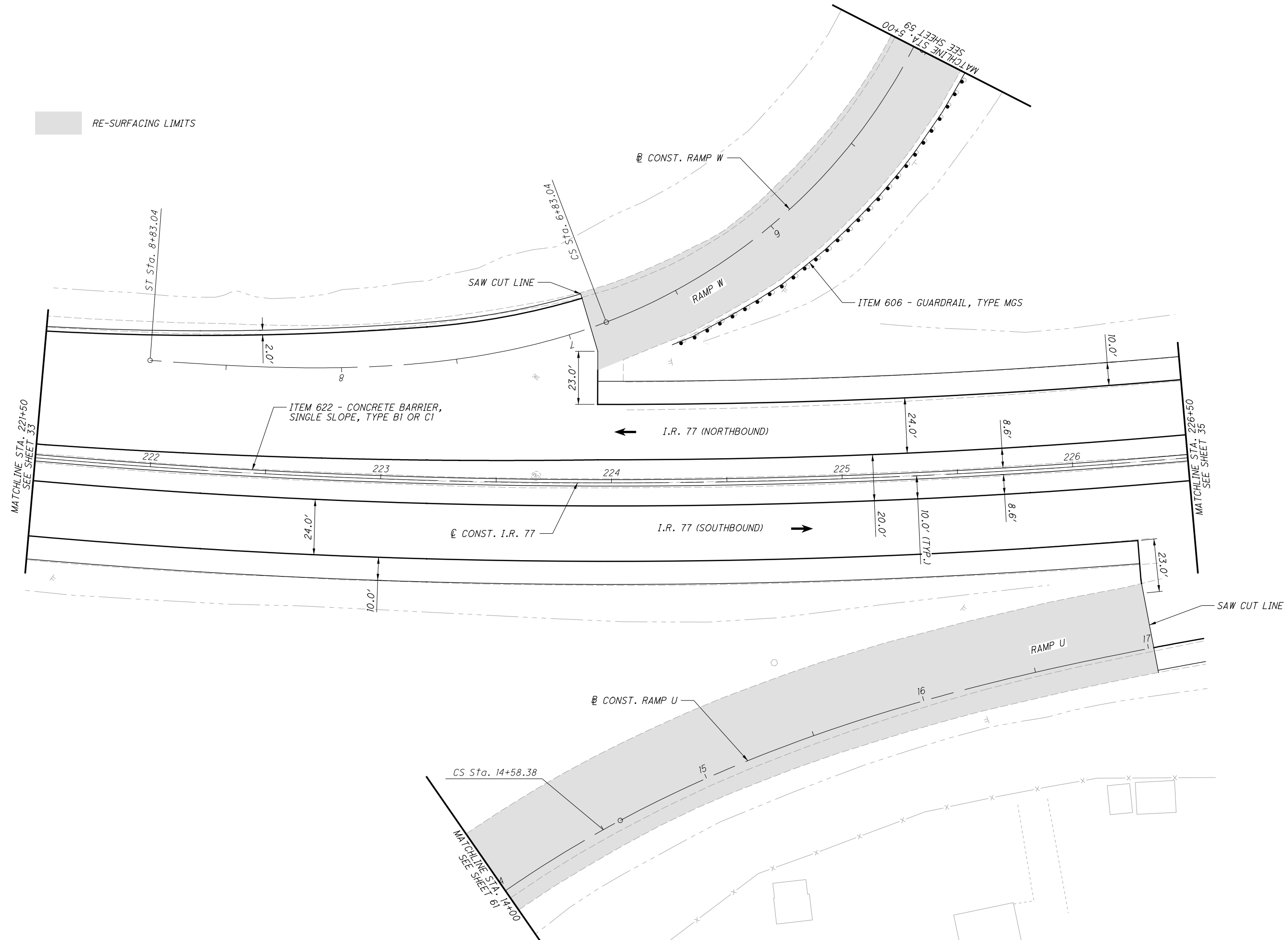

CALCULATED
M.L.L.
CHECKED
J.T.W.

PLAN - I.R. 77
STA. 221+50 TO STA. 226+50

SUM-76 / 77 / 8-
8.24 / 9.74 / 0.00

34
138

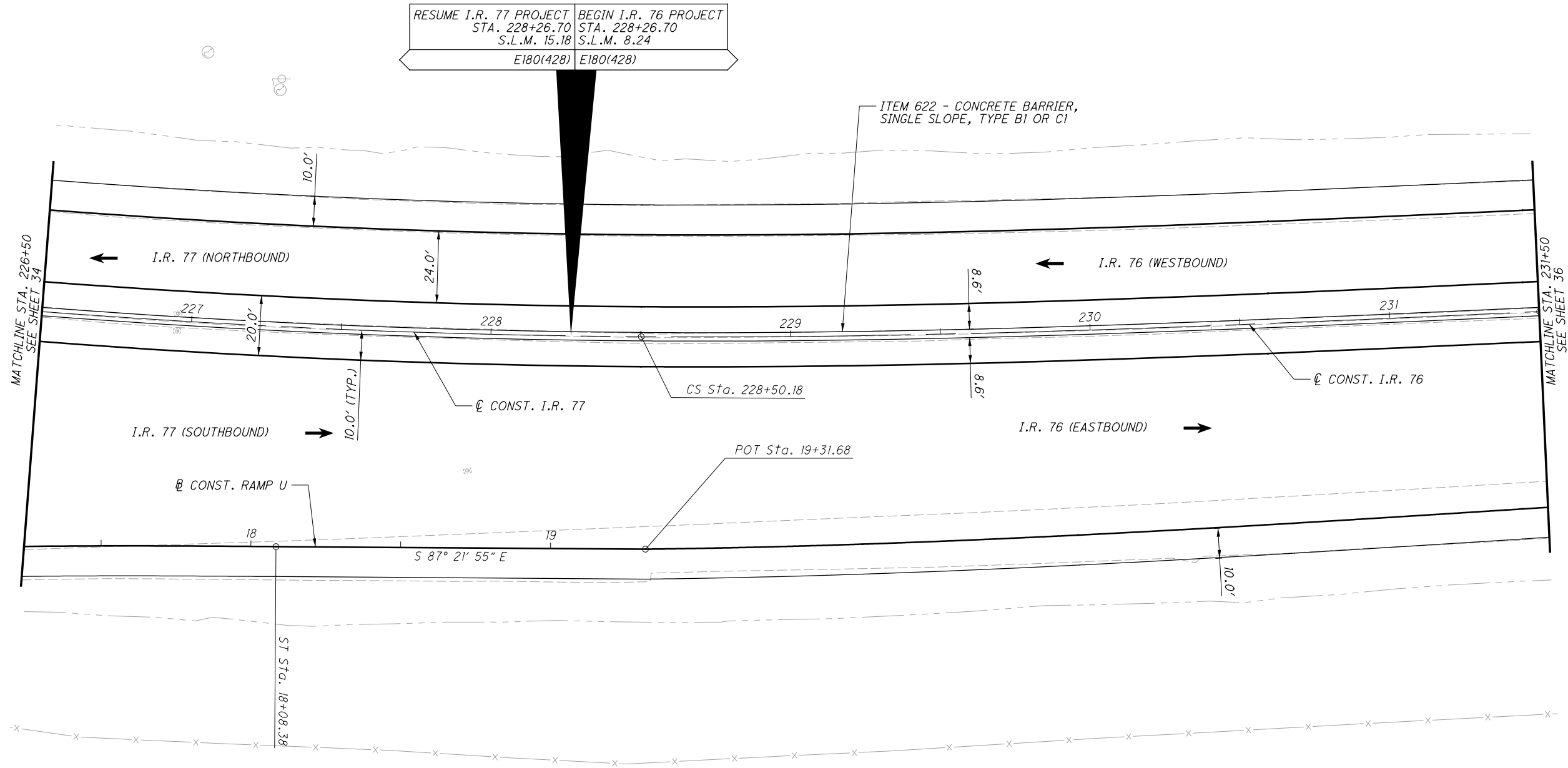

RESUME I.R. 77 PROJECT STA. 228+26.70 S.L.M. 15.18 E180(428)	BEGIN I.R. 76 PROJECT STA. 228+26.70 S.L.M. 8.24 E180(428)
---	---

ITEM 622 - CONCRETE BARRIER,
SINGLE SLOPE, TYPE B1 OR C1

CALCULATED
MLL
CHECKED
JTW

0 20 40
HORIZONTAL
SCALE IN FEET

PLAN - I.R. 76 / I.R. 77
STA. 226+50 TO STA. 231+50

SUM-76 / 77 / 8-
8.24 / 9.74 / 0.00

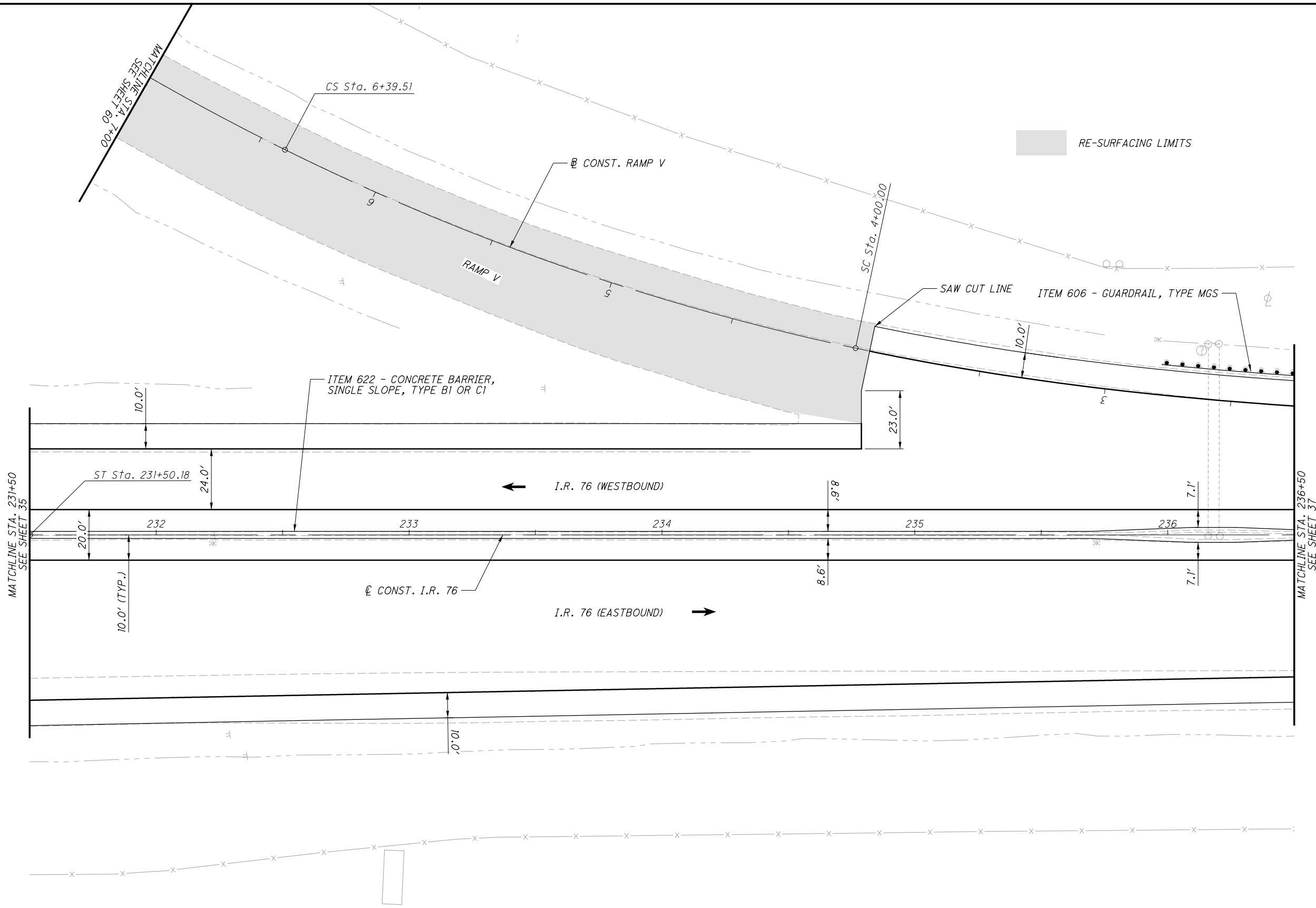

CALCULATED
M.L.L.
CHECKED
J.T.W.

0 20 40
HORIZONTAL
SCALE IN FEET

PLAN - I.R. 76
STA. 231+50 TO STA. 236+50

SUM-76 / 77 / 8-
8.24 / 9.74 / 0.00

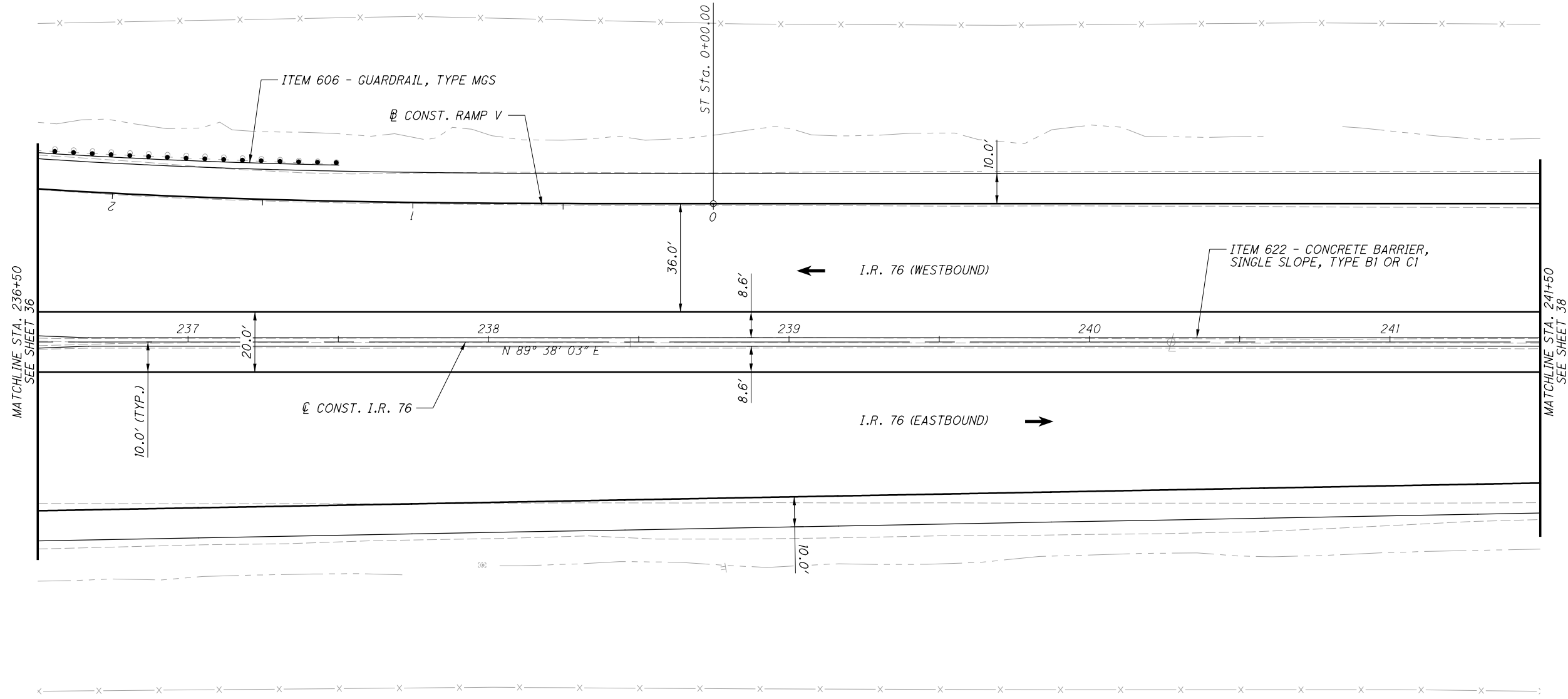

CALCULATED
MLL
CHECKED
JTW

0 20 40
HORIZONTAL
SCALE IN FEET

PLAN - I.R. 76
STA. 236+50 TO STA. 241+50

SUM-76 / 77 / 8-
8.24 / 9.74 / 0.00

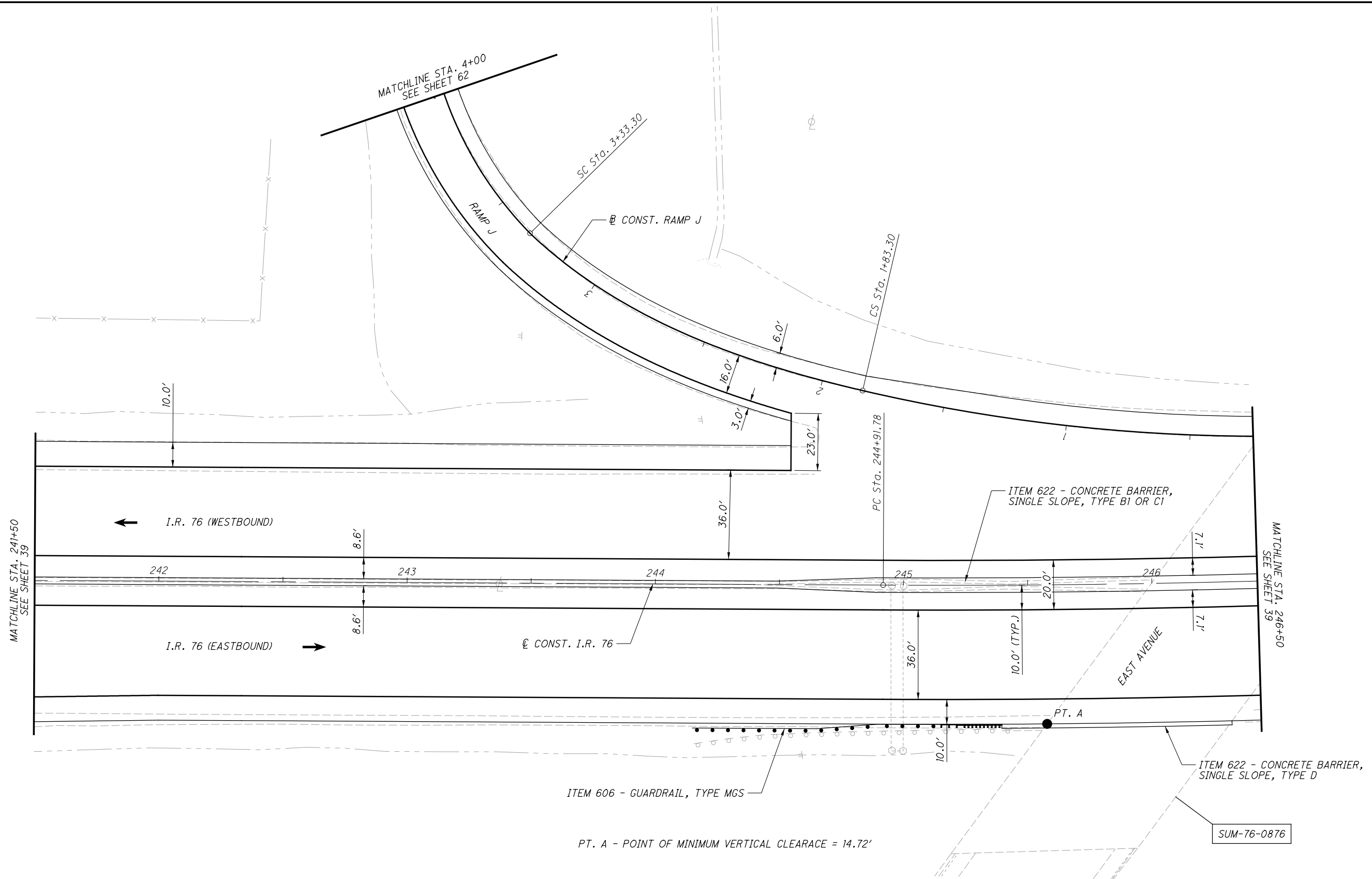

CALCULATED
MLL
CHECKED
JTW

0 20 40
HORIZONTAL
SCALE IN FEET

PLAN - I.R. 76
STA. 241+50 TO STA. 246+50

SUM-76 / 77 / 8-
8.24 / 9.74 / 0.00

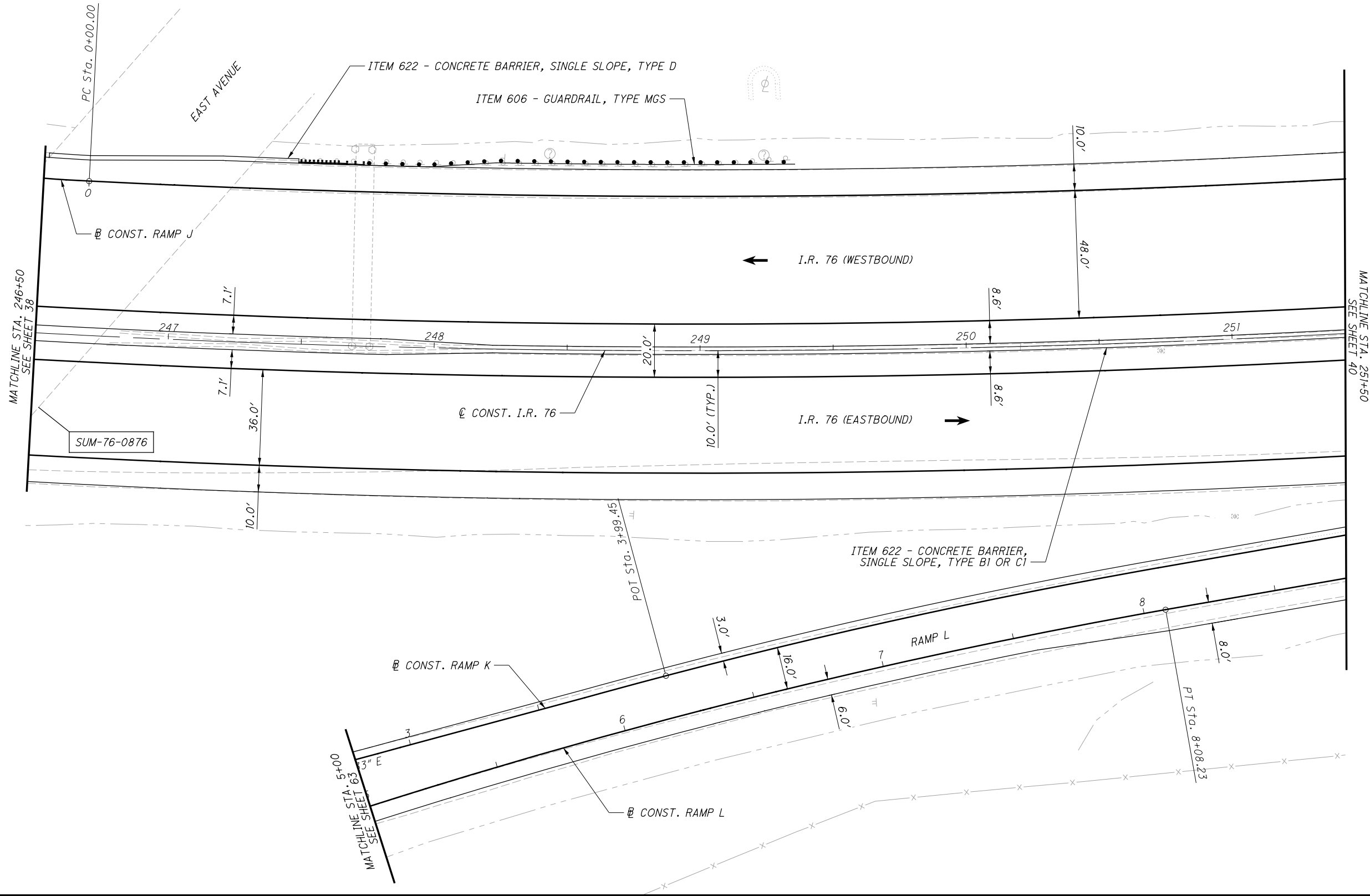

CALCULATED
M.L.L.
CHECKED
J.T.W.

0 20 40
HORIZONTAL
SCALE IN FEET

PLAN - I.R. 76
STA. 246+50 TO STA. 251+50

SUM-76 / 77 / 8-
8.24 / 9.74 / 0.00

P:\02329_SUM-76_77\Design\Roadway\Sheets\02329_GPI03.dgn Sheet 1 8/7/2020 11:31:17 AM mlutes

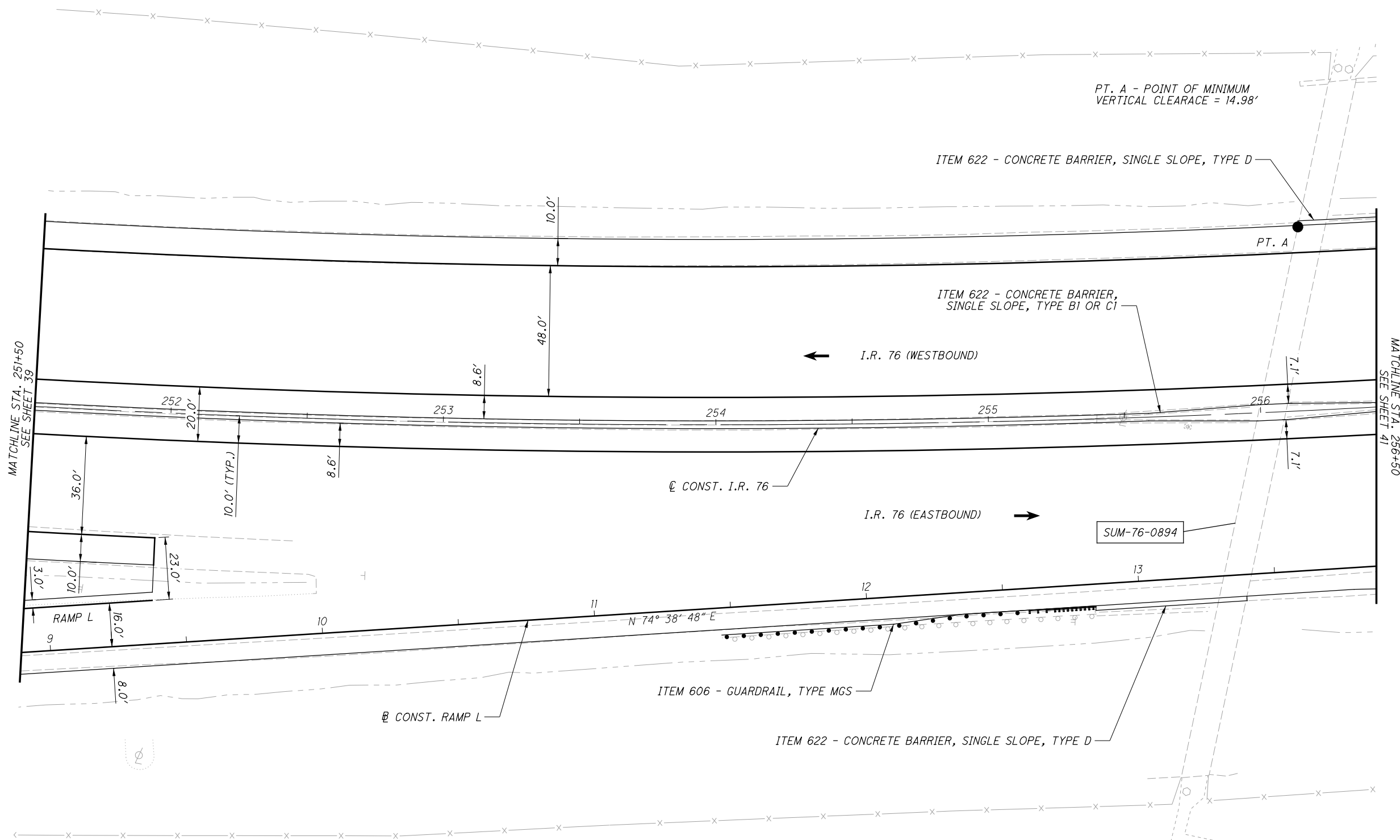

CALCULATED
MLL
CHECKED
JTW

PLAN - I.R. 76
STA. 251+50 TO STA. 256+50

SUM-76 / 77 / 8-
8.24 / 9.74 / 0.00

P:\02329_SUM-76_77\Design\Roadway\Sheets\02329_GPI04.dgn Sheet 1 8/7/2020 11:31:18 AM mlutes

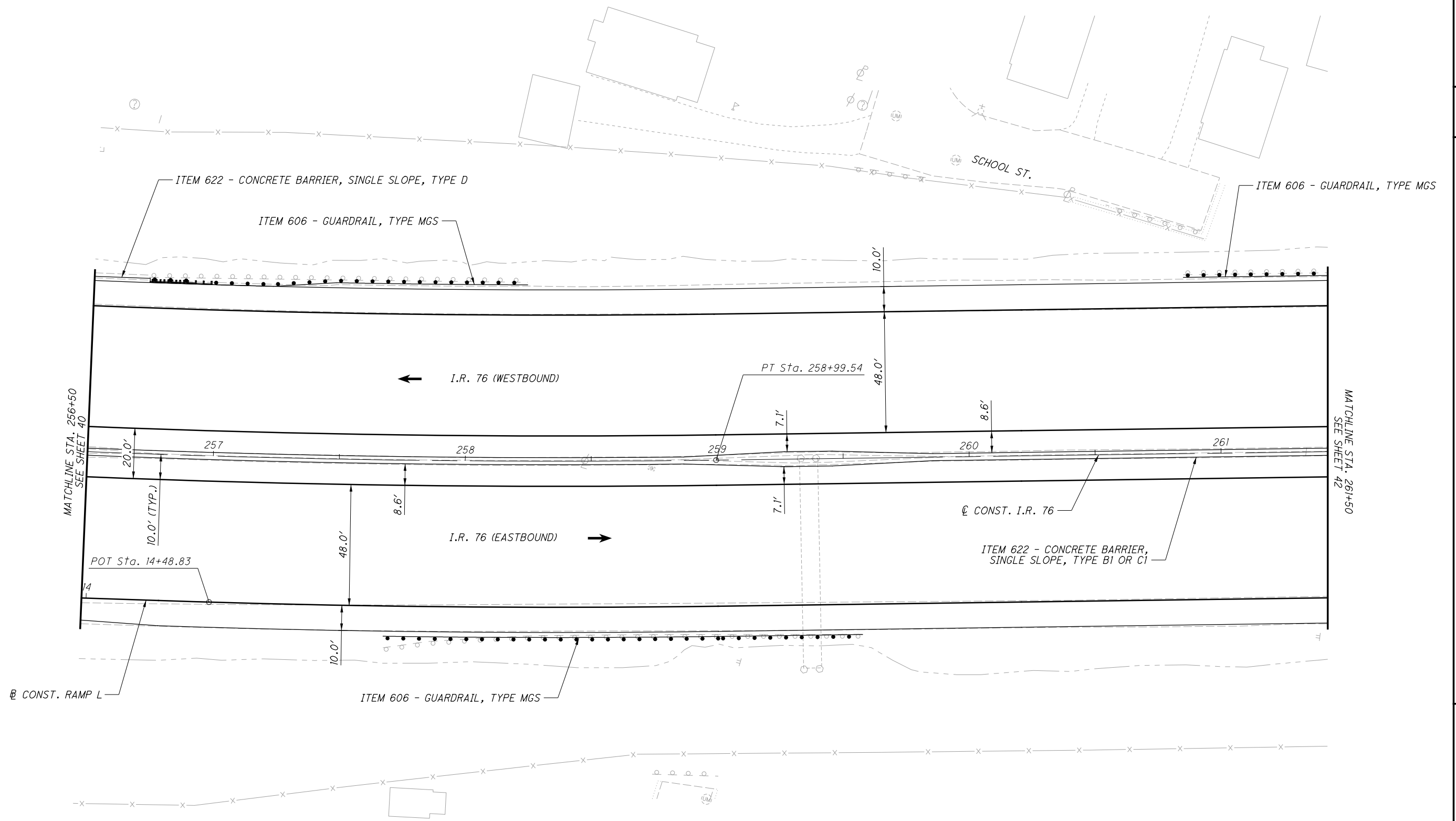

CALCULATED
M.L.L.
CHECKED
J.T.W.

0 20 40
HORIZONTAL
SCALE IN FEET

PLAN - I.R. 76
STA. 256+50 TO STA. 261+50

SUM-76 / 77 / 8-
8.24 / 9.74 / 0.00

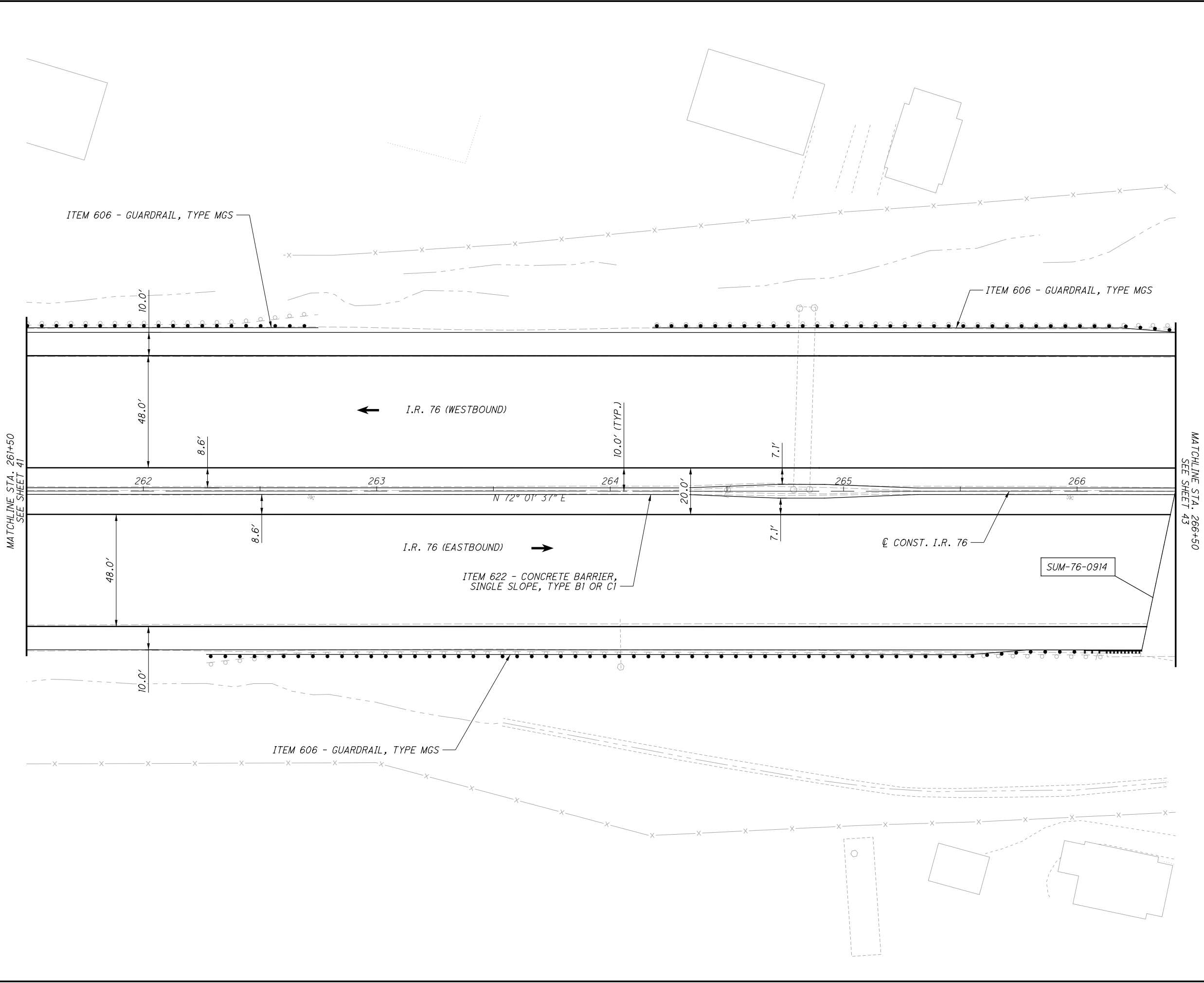

CALCULATED
M.L.L.
CHECKED
J.T.W.

0 20 40
HORIZONTAL
SCALE IN FEET

PLAN - I.R. 76
STA. 261+50 TO STA. 266+50

SUM-76 / 77 / 8-
8.24 / 9.74 / 0.00

42
138

PT. A - POINT OF MINIMUM VERTICAL CLEARANCE = 14.75'

MATCHLINE STA. 266+50
SEE SHEET 42

MANCHESTER ROAD

SUM-76-0914

PT. A

RUSSELL AVENUE

I.R. 76 (WESTBOUND)

PC Sta. 268+31.72

I.R. 76 (EASTBOUND)

ITEM 606 - GUARDRAIL, TYPE MGS

ITEM 622 - CONCRETE BARRIER,
SINGLE SLOPE, TYPE B1 OR C1

CONST. I.R. 76

PC Sta. 0+00.00

CONST. RAMP G

MATCHLINE STA. 271+50
SEE SHEET 44

SOUTH STREET

CALCULATED
MILL
CHECKED
JTW

HORIZONTAL SCALE IN FEET

PLAN - I.R. 76
STA. 266+50 TO STA. 271+50

SUM-76 / 77 / 8-
8.24 / 9.74 / 0.00

P:\02329_SUM-76_77\Design\Roadway\Sheets\02329_GPI07.dgn Sheet 1 8/7/2020 11:31:21 AM mlutes

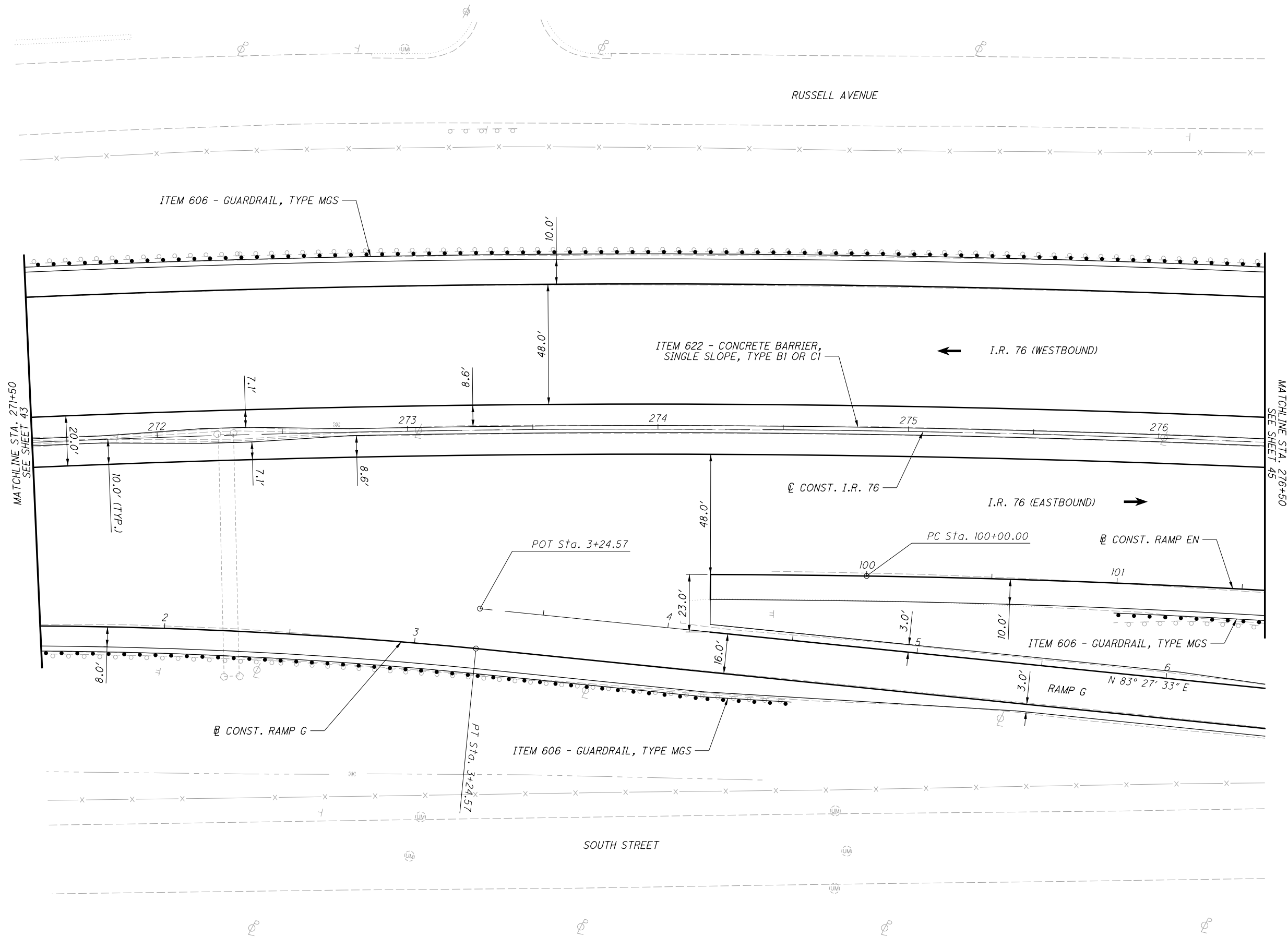

CALCULATED
M.L.L.
CHECKED
J.T.W.

PLAN - I.R. 76
STA. 271+50 TO STA. 276+50

SUM-76 / 77 / 8-
8.24 / 9.74 / 0.00

P:\102329_SUM-76_77\Design\Roadway\Sheets\102329_GPI08.dgn Sheet 1 8/7/2020 11:31:22 AM mlutes

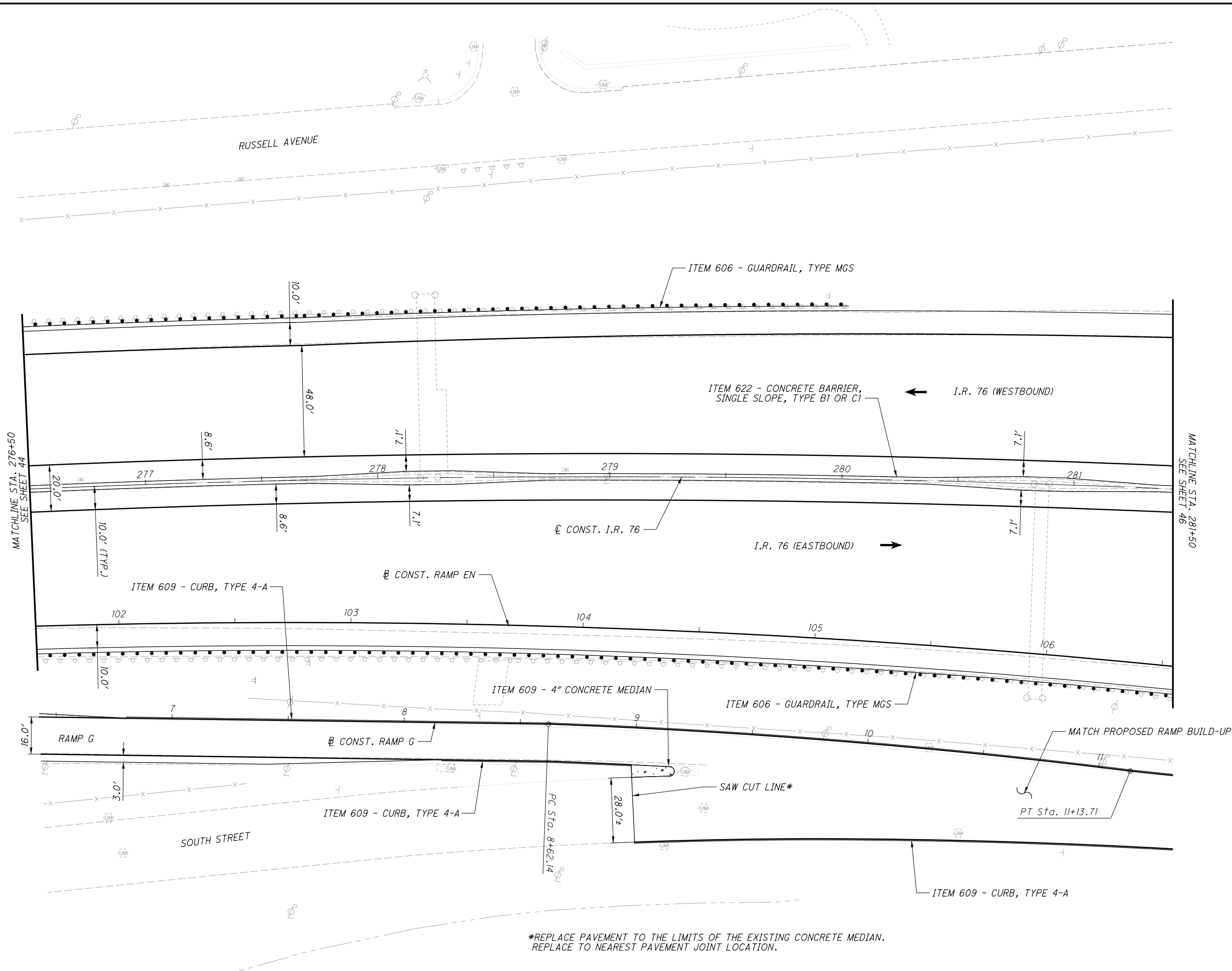

CALCULATED
MILL
CHECKED
JTJ

0 20 40
HORIZONTAL
SCALE IN FEET

PLAN - I.R. 76
STA. 276+50 TO STA. 281+50

SUM-76 / 77 / 8-
8.24 / 9.74 / 0.00

45
138

*REPLACE PAVEMENT TO THE LIMITS OF THE EXISTING CONCRETE MEDIAN.
REPLACE TO NEAREST PAVEMENT JOINT LOCATION.

P:\02329_SUM-76_77\Design\Roadway\Sheets\02329_GPI09.dgn Sheet 1 8/7/2020 11:31:23 AM mlutes

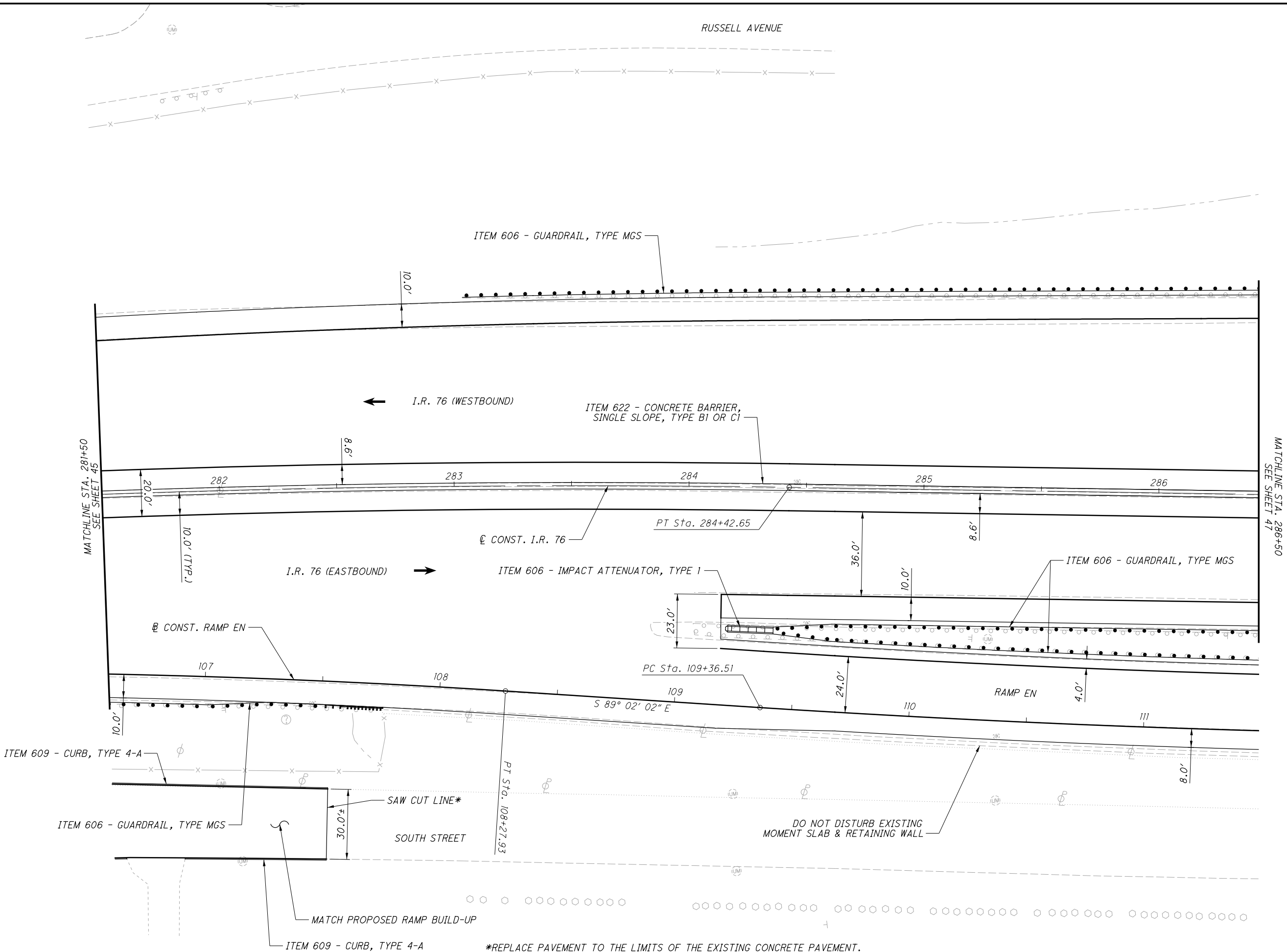

CALCULATED
MLL
CHECKED
JTW

0 20 40
HORIZONTAL
SCALE IN FEET

PLAN - I.R. 76
STA. 281+50 TO STA. 286+50

SUM-76 / 77 / 8-
8.24 / 9.74 / 0.00

P:\02329_SUM-76_77\Design\Roadway\Sheets\02329_GPI10.dgn Sheet 1 8/7/2020 11:31:24 AM mlj/tes

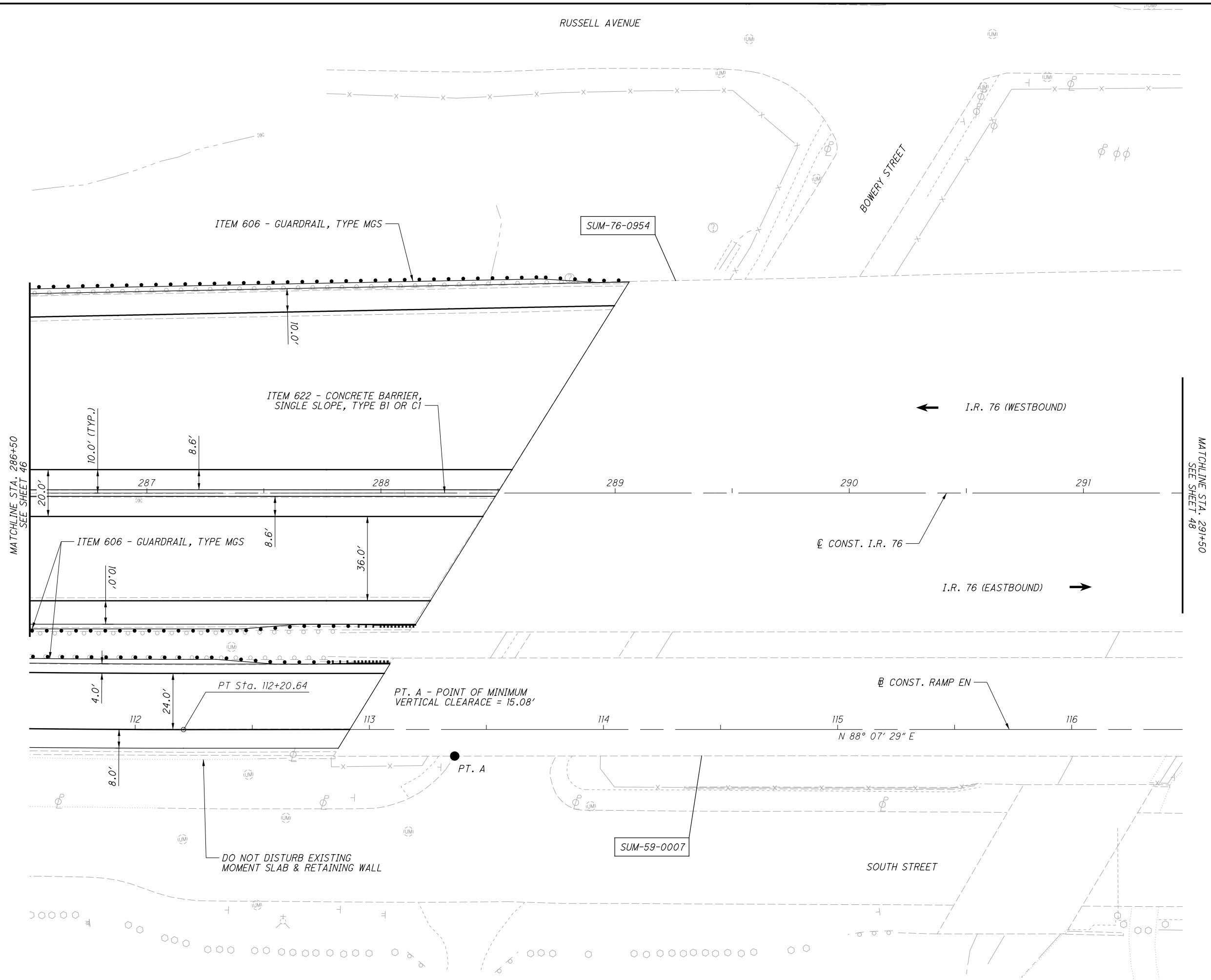

CALCULATED
M.L.L.
CHECKED
J.T.W.

0 20 40
HORIZONTAL
SCALE IN FEET

PLAN - I.R. 76
STA. 286+50 TO STA. 291+50

SUM-76 / 77 / 8-
8.24 / 9.74 / 0.00

P:\02329_SUM-76_77\Design\Roadway\Sheets\02329_GPill.dgn Sheet 1 8/7/2020 11:31:25 AM mlutes

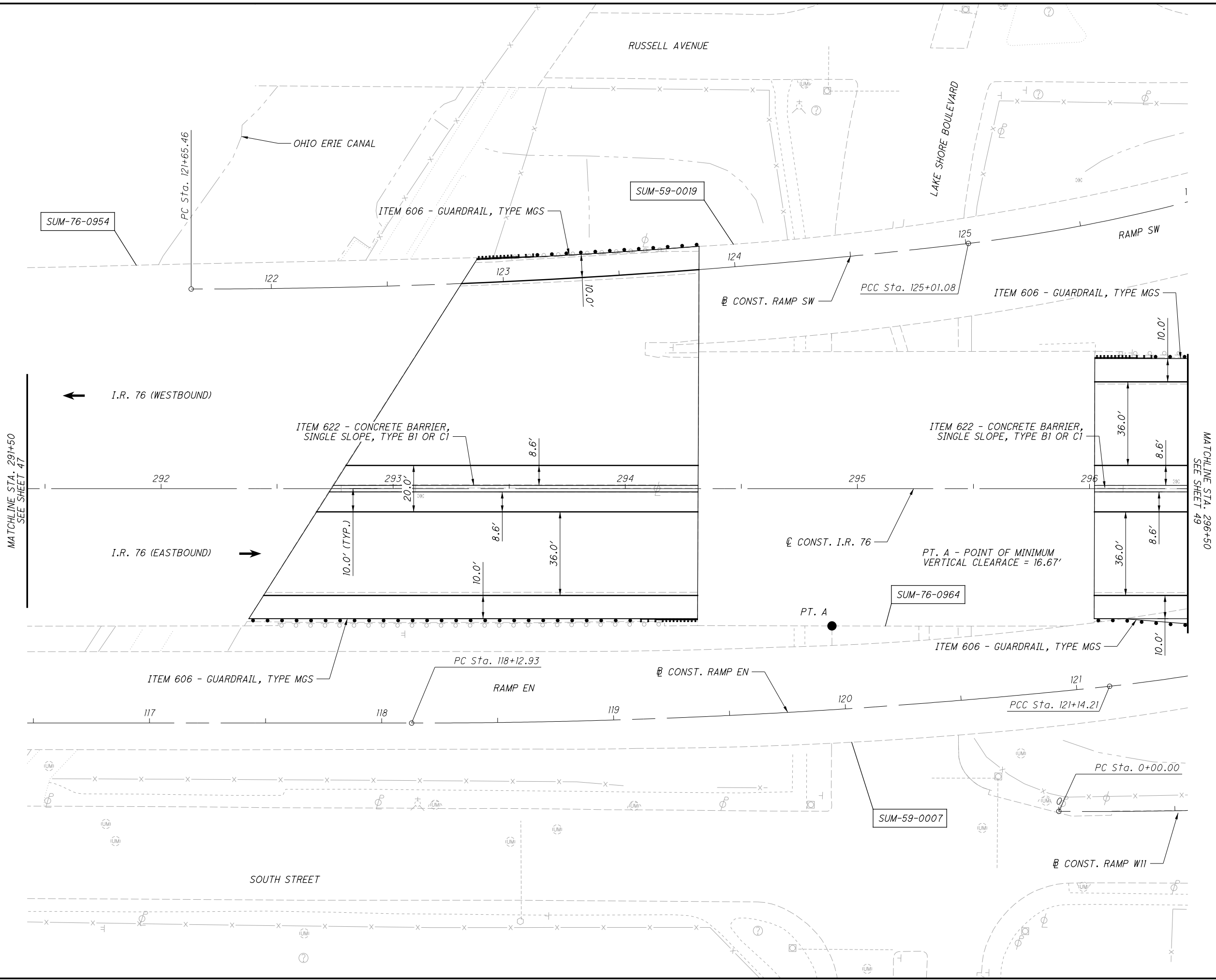

CALCULATED
M.L.L.
CHECKED
J.T.W.

0 20 40
HORIZONTAL
SCALE IN FEET

PLAN - I.R. 76
STA. 291+50 TO STA. 296+50

SUM-76 / 77 / 8-
8.24 / 9.74 / 0.00

48
138

P:\02329_SUM-76_77\Design\Roadway\Sheets\02329_GPII2.dgn Sheet 1 8/7/2020 11:31:27 AM mlj/tes

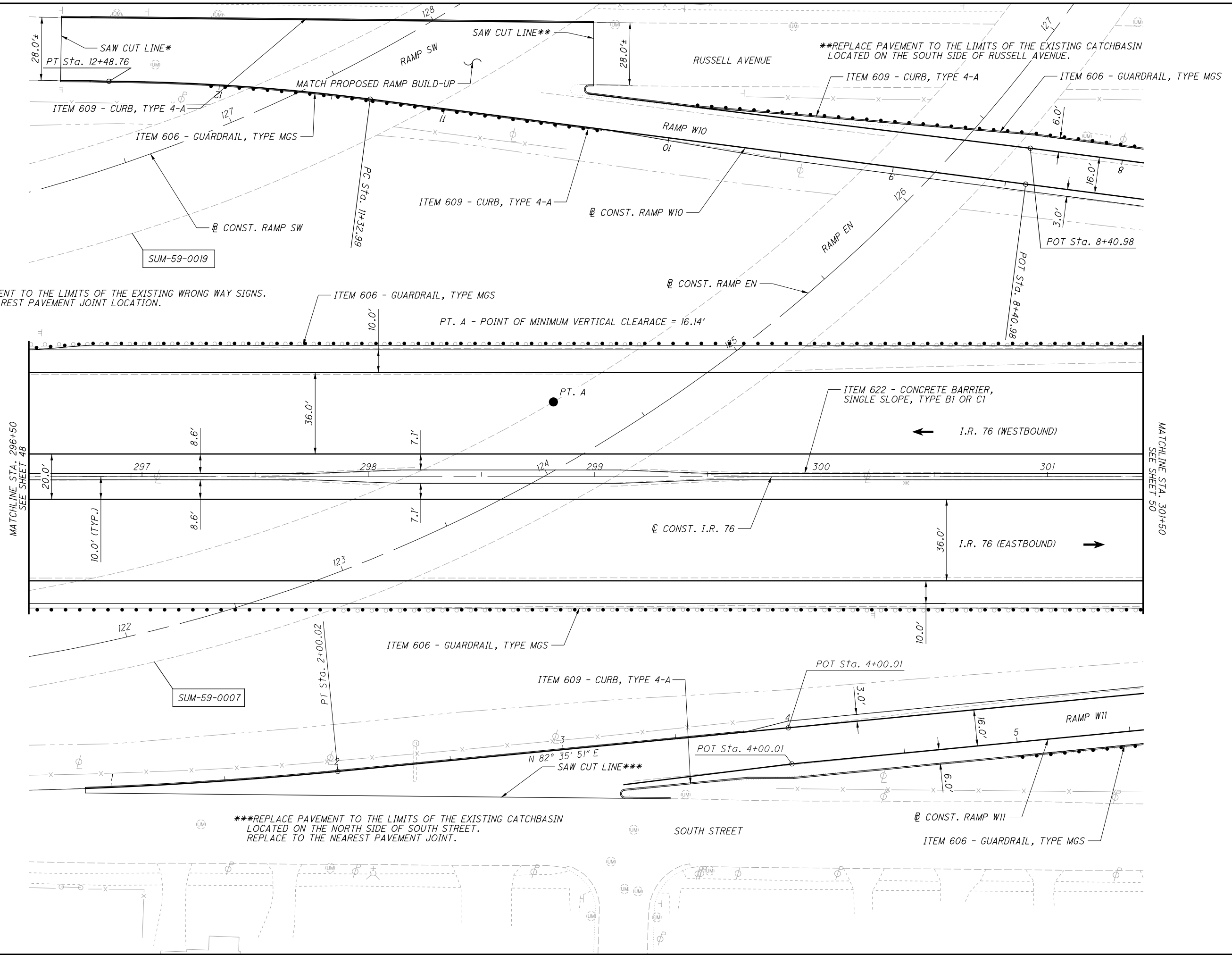

*REPLACE PAVEMENT TO THE LIMITS OF THE EXISTING WRONG WAY SIGNS. REPLACE TO NEAREST PAVEMENT JOINT LOCATION.

***REPLACE PAVEMENT TO THE LIMITS OF THE EXISTING CATCHBASIN LOCATED ON THE NORTH SIDE OF SOUTH STREET. REPLACE TO THE NEAREST PAVEMENT JOINT.

**REPLACE PAVEMENT TO THE LIMITS OF THE EXISTING CATCHBASIN LOCATED ON THE SOUTH SIDE OF RUSSELL AVENUE.

CALCULATED
M.L.L.
CHECKED
J.T.W.

0 20 40
HORIZONTAL SCALE IN FEET

PLAN - I.R. 76
STA. 296+50 TO STA. 301+50

SUM-76/77/8-
8.24/9.74/0.00

P:\02329_SUM-76_77\Design\Roadway\Sheets\02329_GPII3.dgn Sheet | 8/7/2020 11:31:28 AM mlj/tes

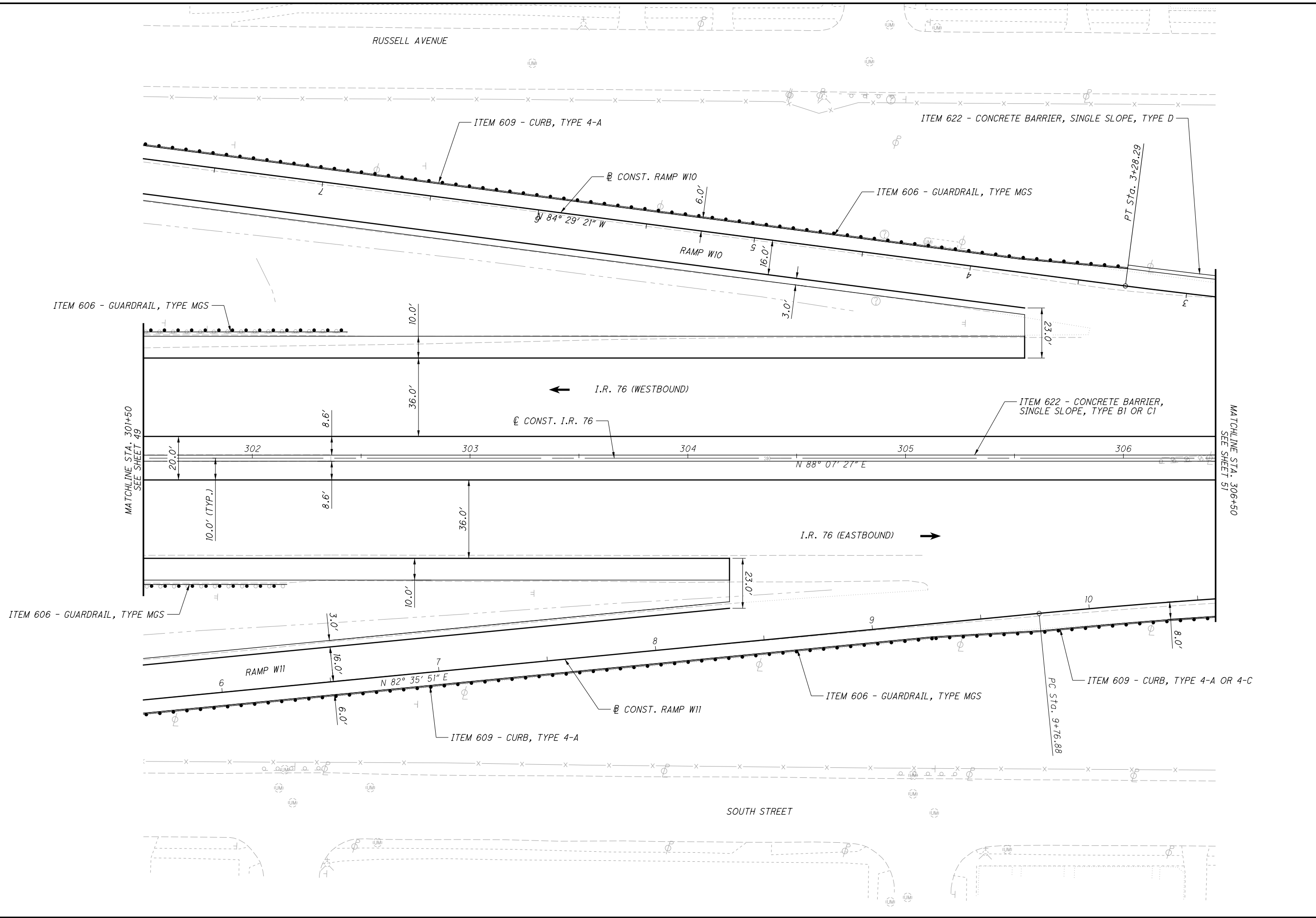

CALCULATED
M.L.L.
CHECKED
J.T.W.

0 20 40
HORIZONTAL
SCALE IN FEET

PLAN - I.R. 76
STA. 301+50 TO STA. 306+50

SUM-76 / 77 / 8-
8.24 / 9.74 / 0.00

50
138

P:\02329_SUM-76_77\Design\Roadway\Sheets\02329_GPII4.dgn Sheet 1 8/7/2020 11:31:29 AM mlutes

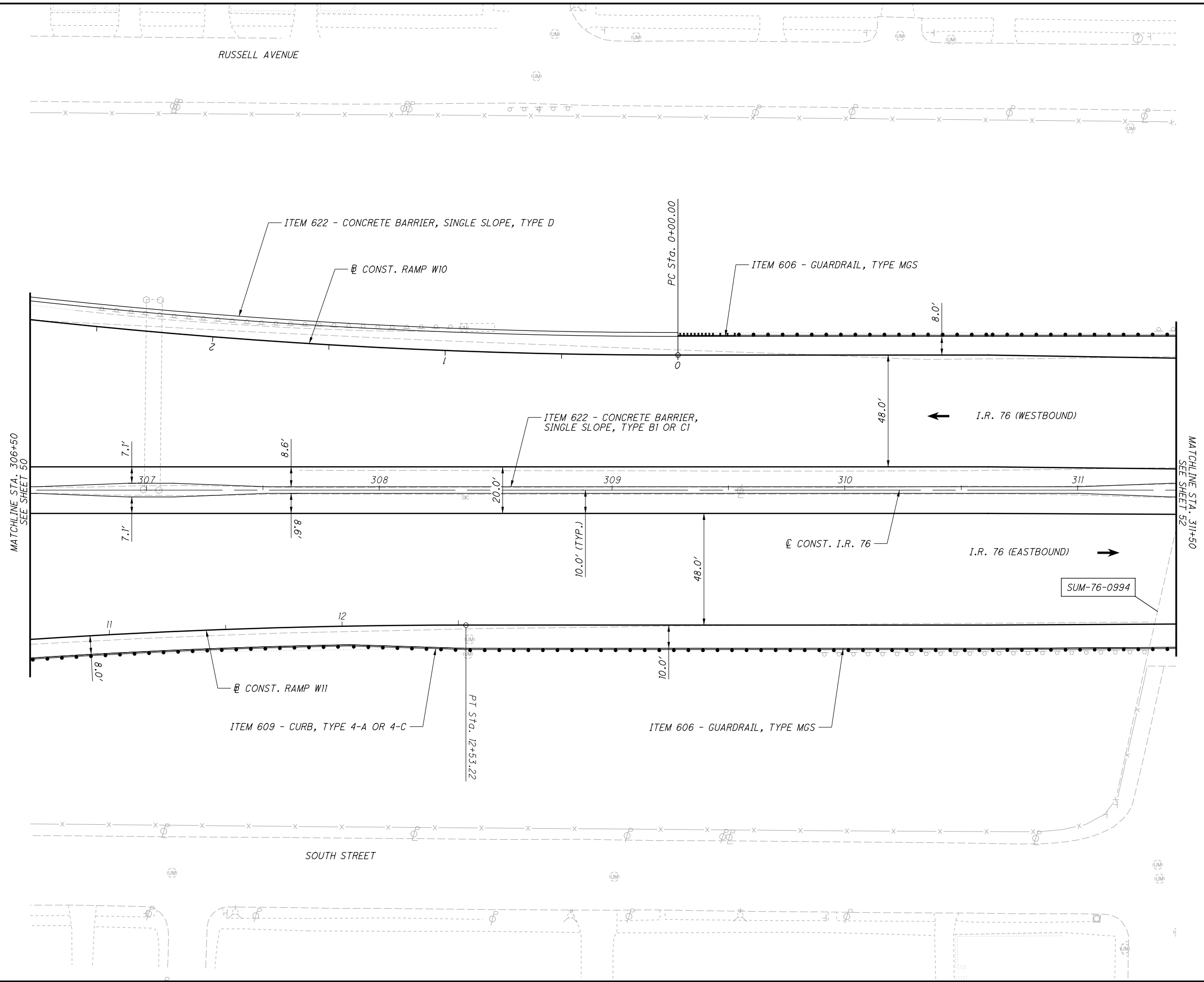

CALCULATED
MILL
CHECKED
JTW

0 20 40
HORIZONTAL
SCALE IN FEET

PLAN - I.R. 76
STA. 306+50 TO STA. 311+50

SUM-76 / 77 / 8-
8.24 / 9.74 / 0.00

51
138

P:\02329_SUM-76_77\Design\Roadway\Sheets\02329_GPII5.dgn Sheet 1 8/7/2020 11:31:32 AM mlutes

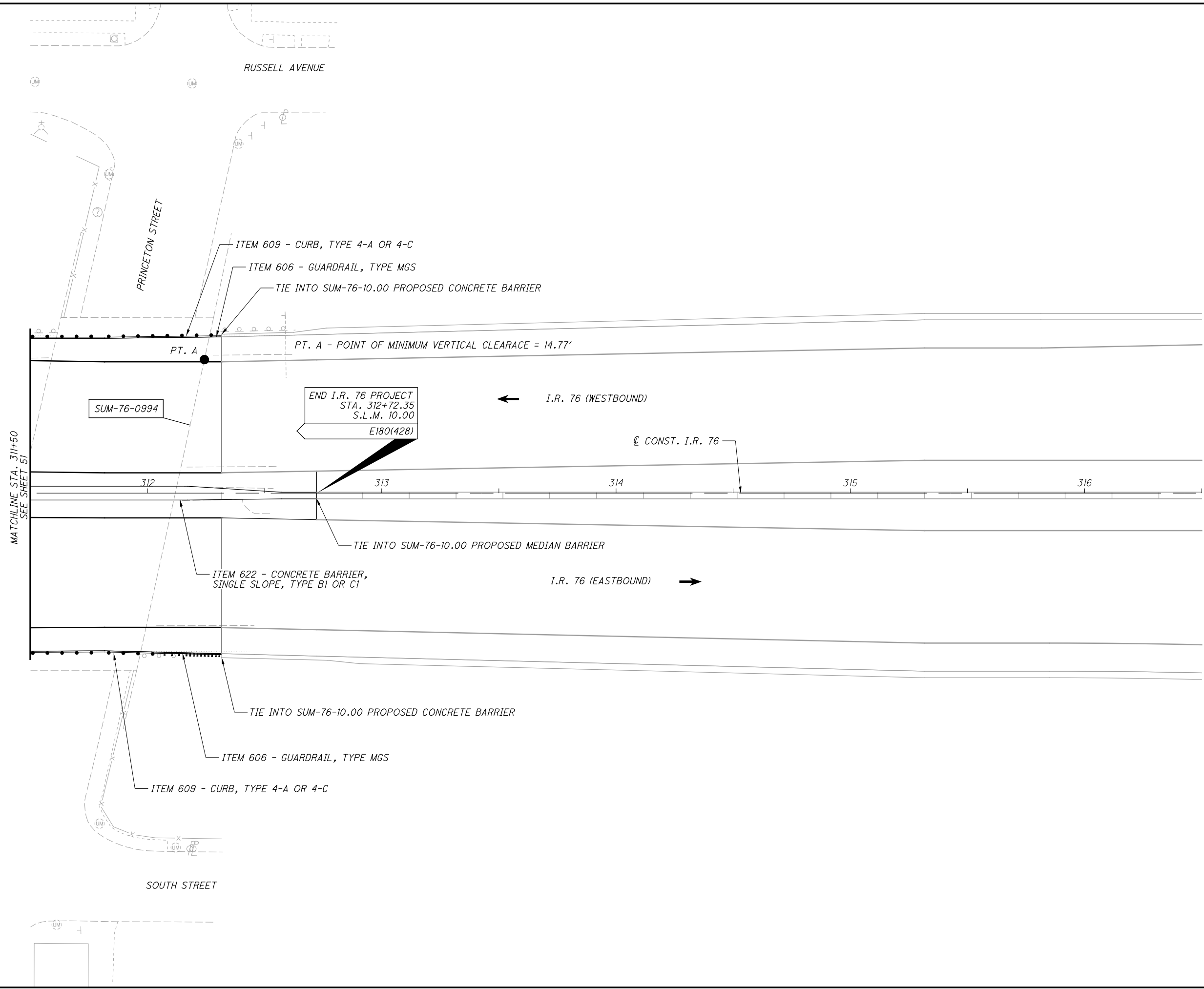

CALCULATED
M.L.L.
CHECKED
J.T.W.

0 20 40
HORIZONTAL
SCALE IN FEET

PLAN - I.R. 76
STA. 311+50 TO END I.R. 76 PROJECT

SUM-76 / 77 / 8-
8.24 / 9.74 / 0.00

P:\02329_SUM-76_77\Design\Roadway\Sheets\02329_GP020.dgn Sheet 8/7/2020 11:31:34 AM mlufes

*RESURFACING ENDS AT PHYSICAL GORE OF RAMP M AND I.R. 77

RE-SURFACING LIMITS

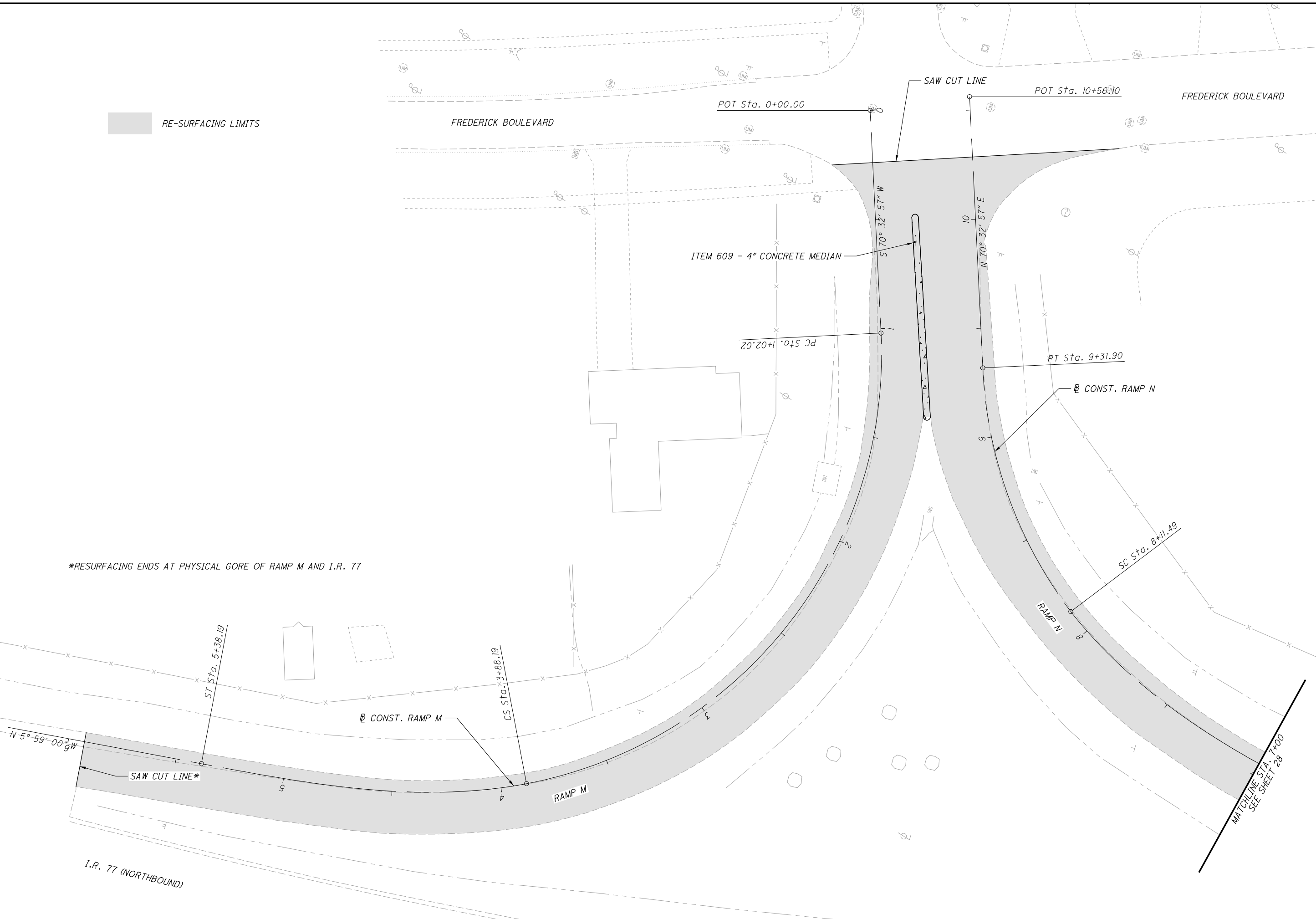

CALCULATED
MLL
CHECKED
JTJW

**PLAN - RAMP M & RAMP N
RE-SURFACING LIMITS**

**SUM-76 / 77 / 8-
8.24 / 9.74 / 0.00**

P:\02329_SUM-76_77\Design\Roadway\Sheets\02329_GP021.dgn Sheet 8/7/2020 11:31:35 AM milutes

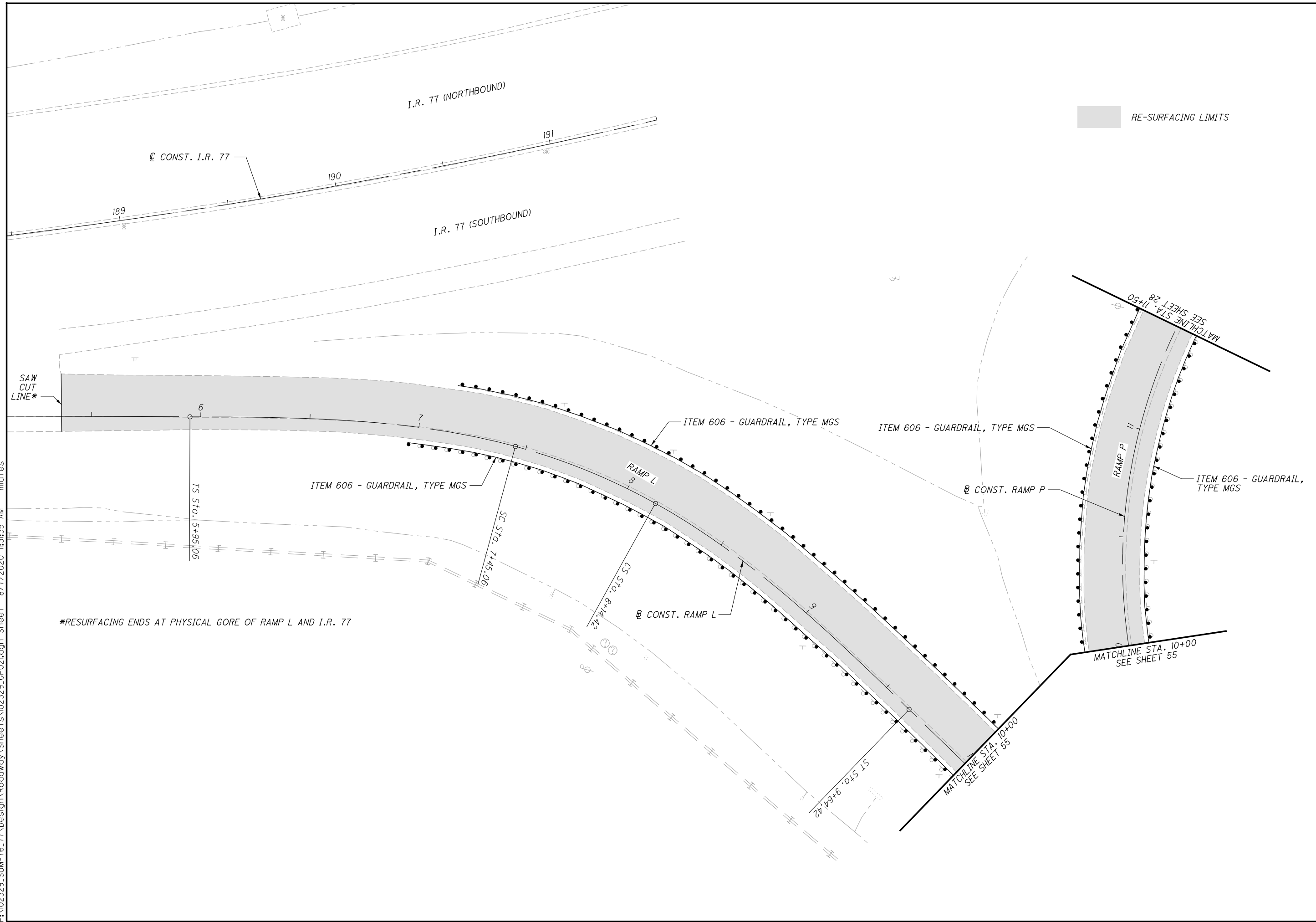

*RESURFACING ENDS AT PHYSICAL GORE OF RAMP L AND I.R. 77

RE-SURFACING LIMITS



CALCULATED
MLL
CHECKED
JTW

PLAN - RAMP L & RAMP P
RE-SURFACING LIMITS

SUM-76 / 77 / 8-
8.24 / 9.74 / 0.00

RE-SURFACING LIMITS

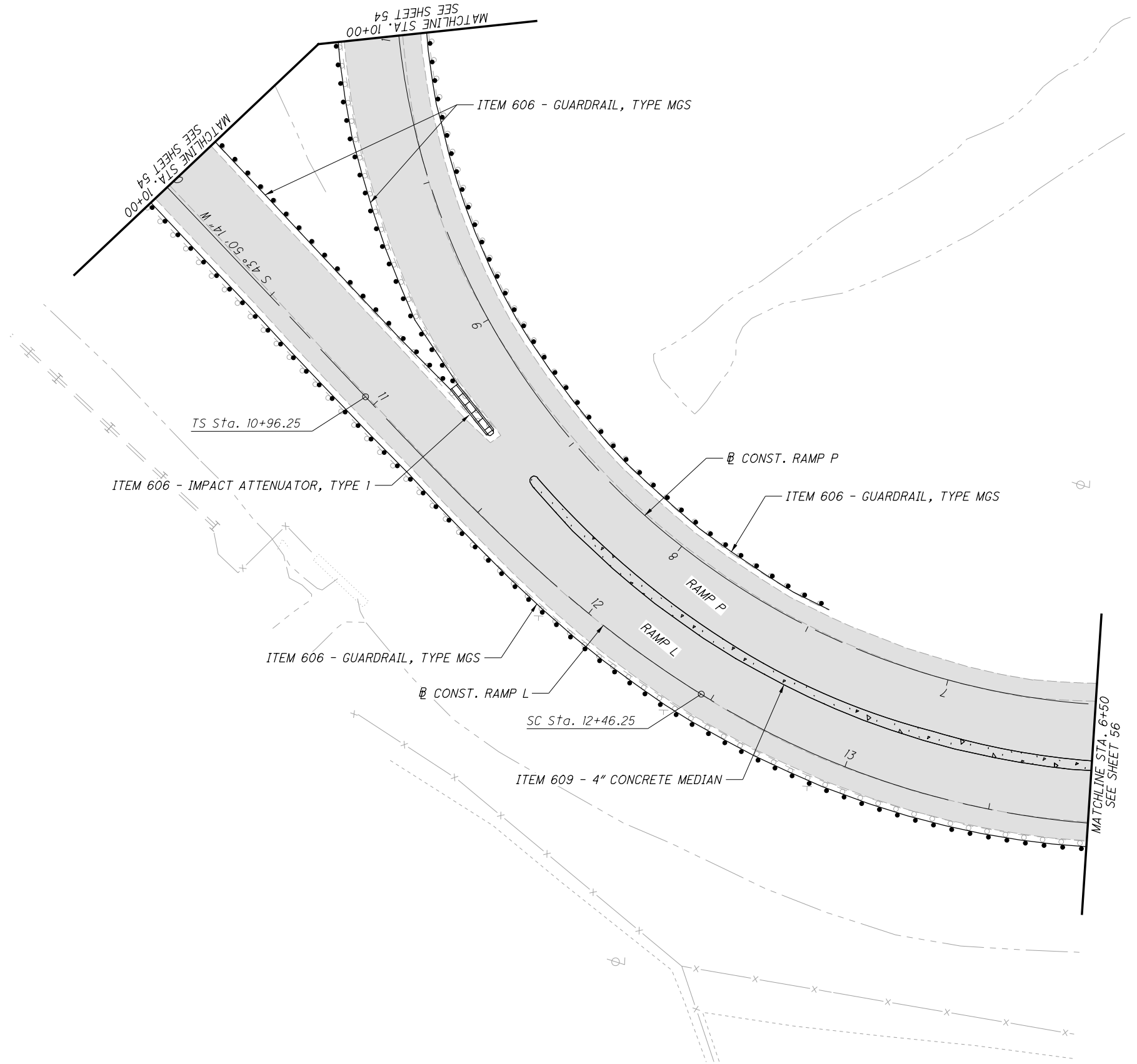

CALCULATED
MLL
CHECKED
JTW

0 20 40
HORIZONTAL
SCALE IN FEET

**PLAN - RAMP L & RAMP P
RE-SURFACING LIMITS**

**SUM-76 / 77 / 8-
8.24 / 9.74 / 0.00**

P:\02329_SUM-76_77\Design\Roadway\Sheets\02329_GP023.dgn Sheet 8/7/2020 11:31:38 AM mlutes

RE-SURFACING LIMITS

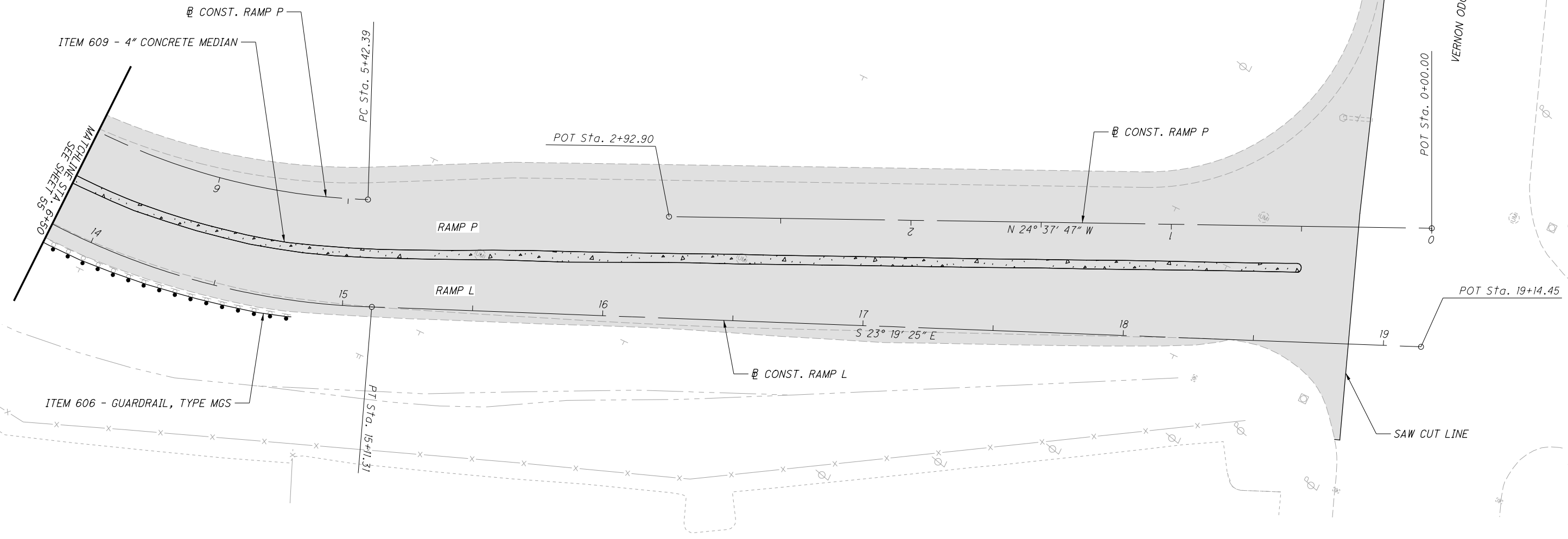

CALCULATED
MILL
CHECKED
JTJ

0 20 40
HORIZONTAL
SCALE IN FEET

**PLAN - RAMP L & RAMP P
RE-SURFACING LIMITS**

**SUM-76 / 77 / 8-
8.24 / 9.74 / 0.00**

P:\102329_SUM-76_77\Design\Roadway\Sheets\102329_GP024.dgn Sheet 8/7/2020 11:31:39 AM mlufes

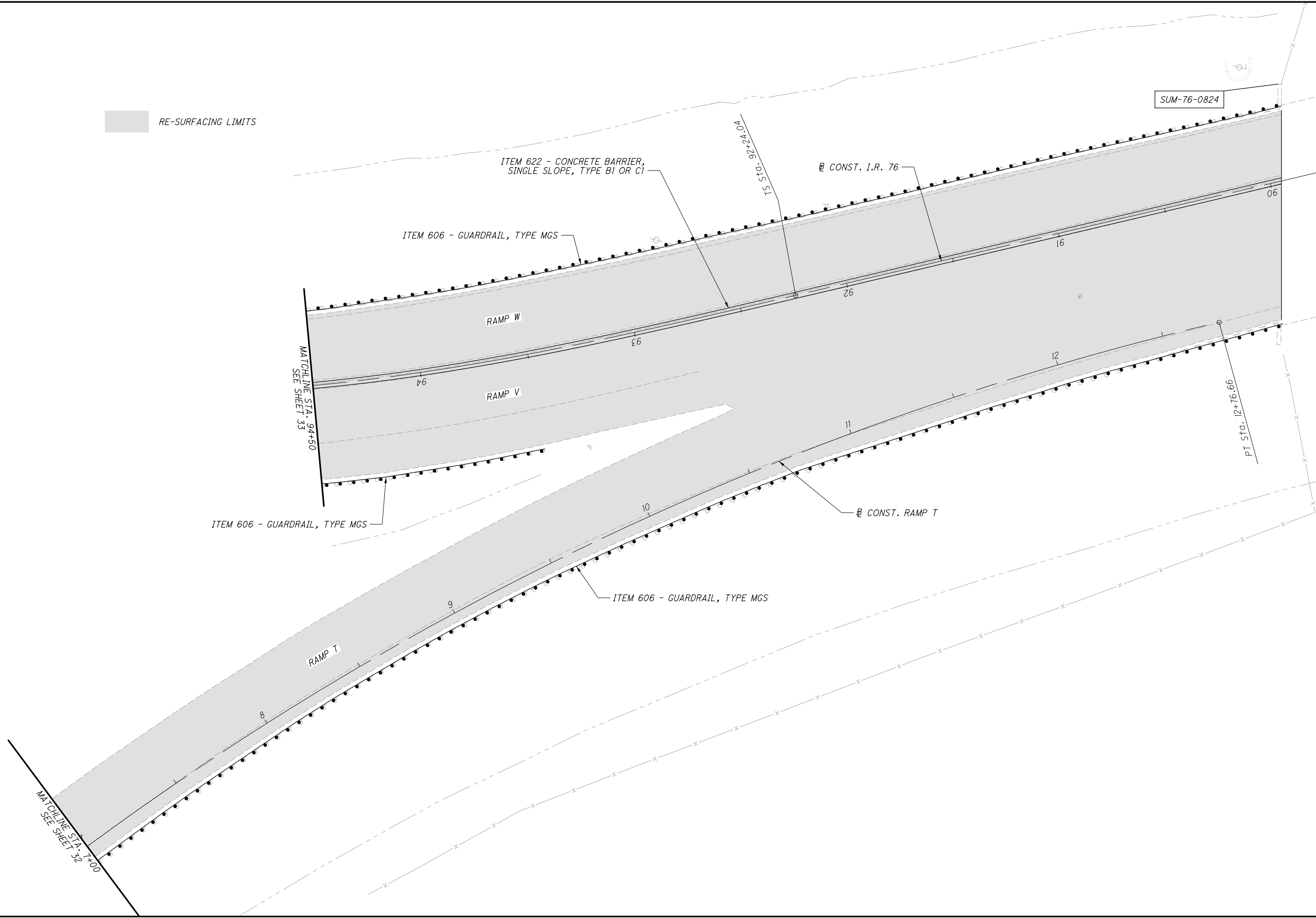

CALCULATED
M.L.L.
CHECKED
J.T.W.

0 20 40
HORIZONTAL SCALE IN FEET

↑
N

PLAN - RAMP T, RAMP V & RAMP W
RE-SURFACING LIMITS

SUM-76/77/8-
8.24/9.74/0.00

P:\02329_SUM-76_77\Design\Roadway\Sheets\02329_GP025.dgn Sheet 8/7/2020 11:31:40 AM miles

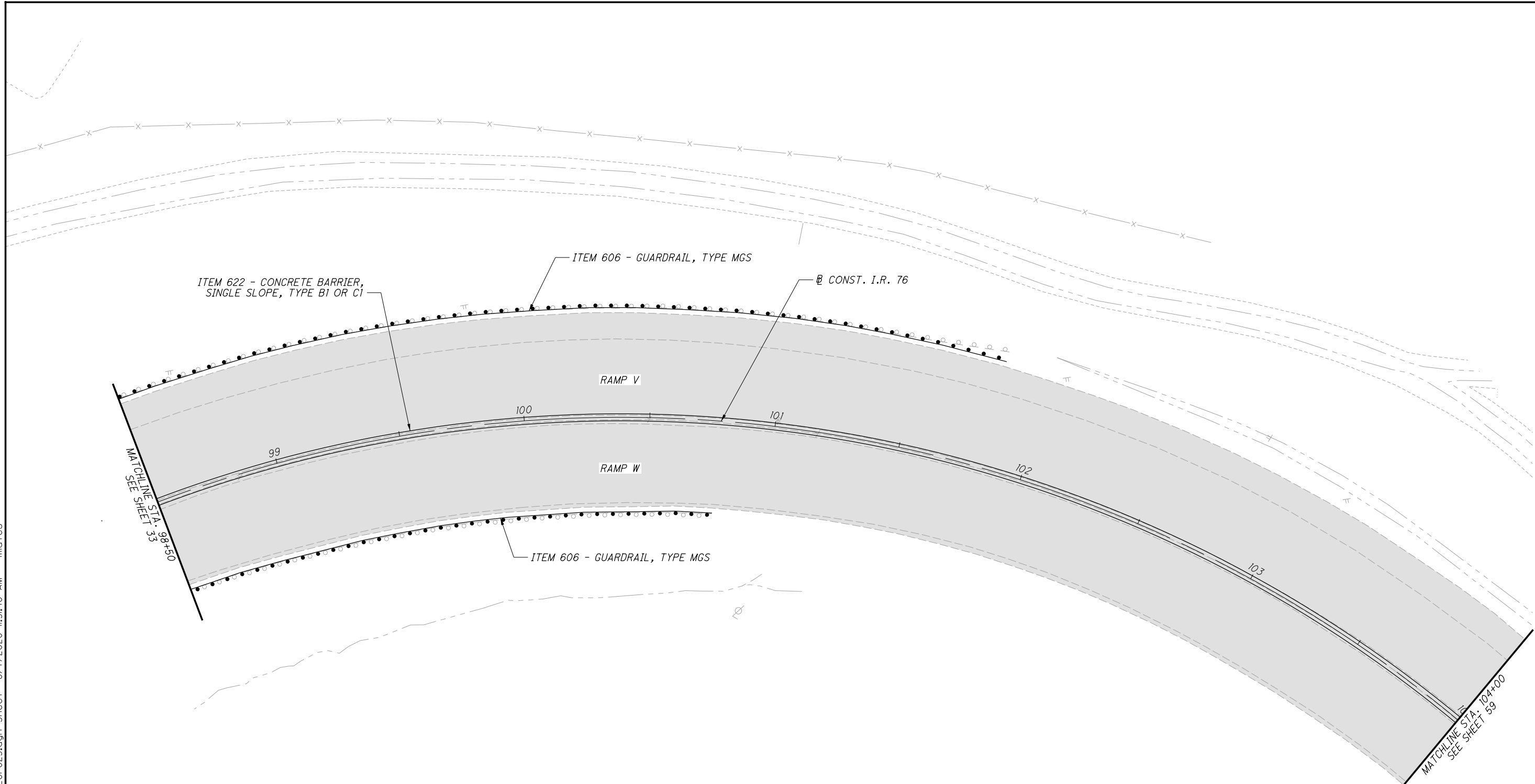

RE-SURFACING LIMITS

CALCULATED
M.L.L.
CHECKED
J.T.W.

0 20 40
HORIZONTAL
SCALE IN FEET

**PLAN - RAMP V & RAMP W
RE-SURFACING LIMITS**

**SUM-76 / 77 / 8-
8.24 / 9.74 / 0.00**

P:\02329_SUM-76_77\Design\Roadway\Sheets\02329_GP026.dgn Sheet 8/7/2020 11:31:41 AM mlj/tes

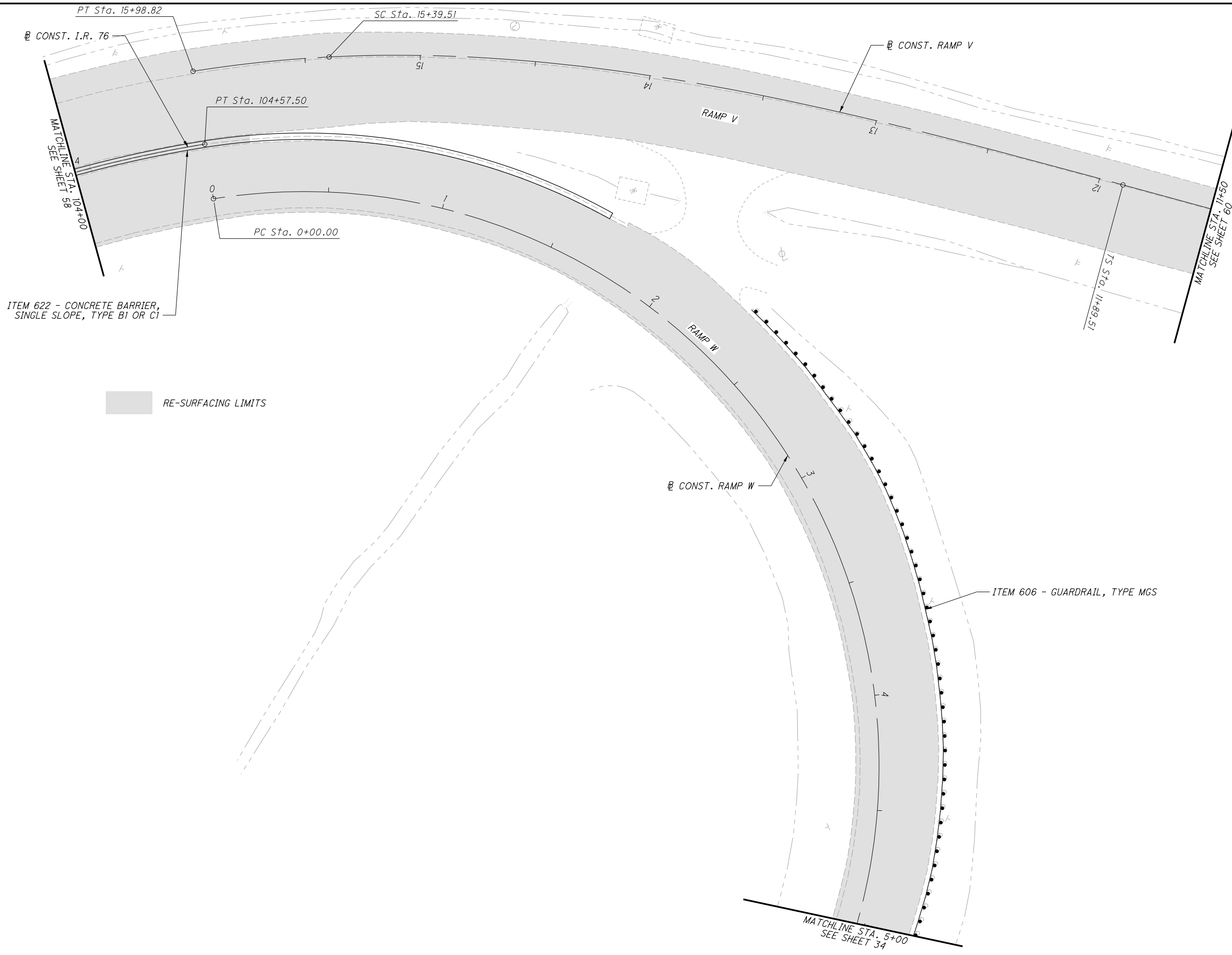

RE-SURFACING LIMITS

CALCULATED
MILL
CHECKED
JTJW

0 20 40
HORIZONTAL
SCALE IN FEET

**PLAN - RAMP V & RAMP W
RE-SURFACING LIMITS**

**SUM-76 / 77 / 8-
8.24 / 9.74 / 0.00**

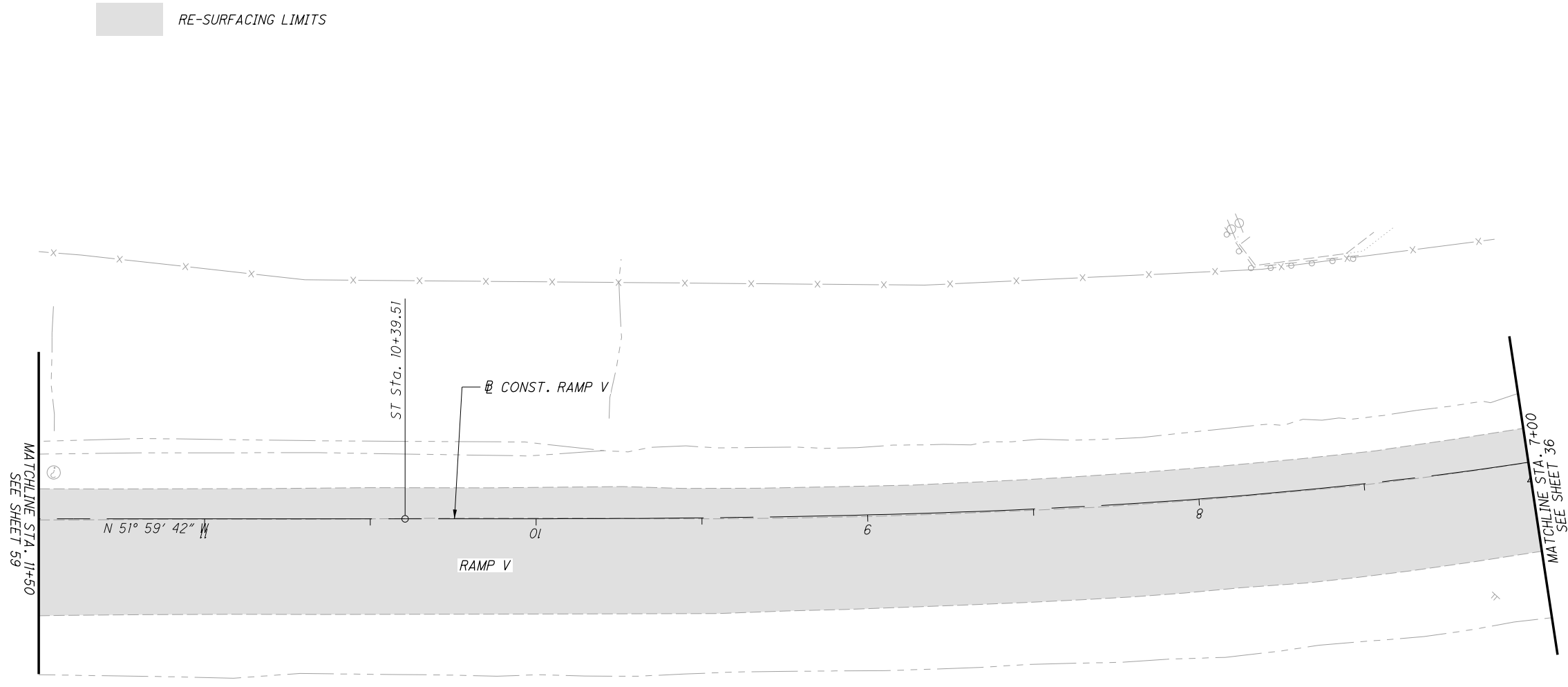

P:\102329_SUM-76_77\Design\Roadway\Sheets\102329_GP028.dgn Sheet 8/7/2020 11:31:43 AM mlufes



NOTES:
 1. FOR RAMP V & RAMP W PLAN VIEW, SEE SHEET 57.

RE-SURFACING LIMITS

CALCULATED
 MLL
 CHECKED
 JTJ

0 20 40
 HORIZONTAL
 SCALE IN FEET

**PLAN - RAMP U
 RE-SURFACING LIMITS**

**SUM-76 / 77 / 8-
 8.24 / 9.74 / 0.00**

P:\02329_SUM-76_77\Design\Roadway\Sheets\02329_GPI16.dgn Sheet 1 8/7/2020 11:31:45 AM mlutes

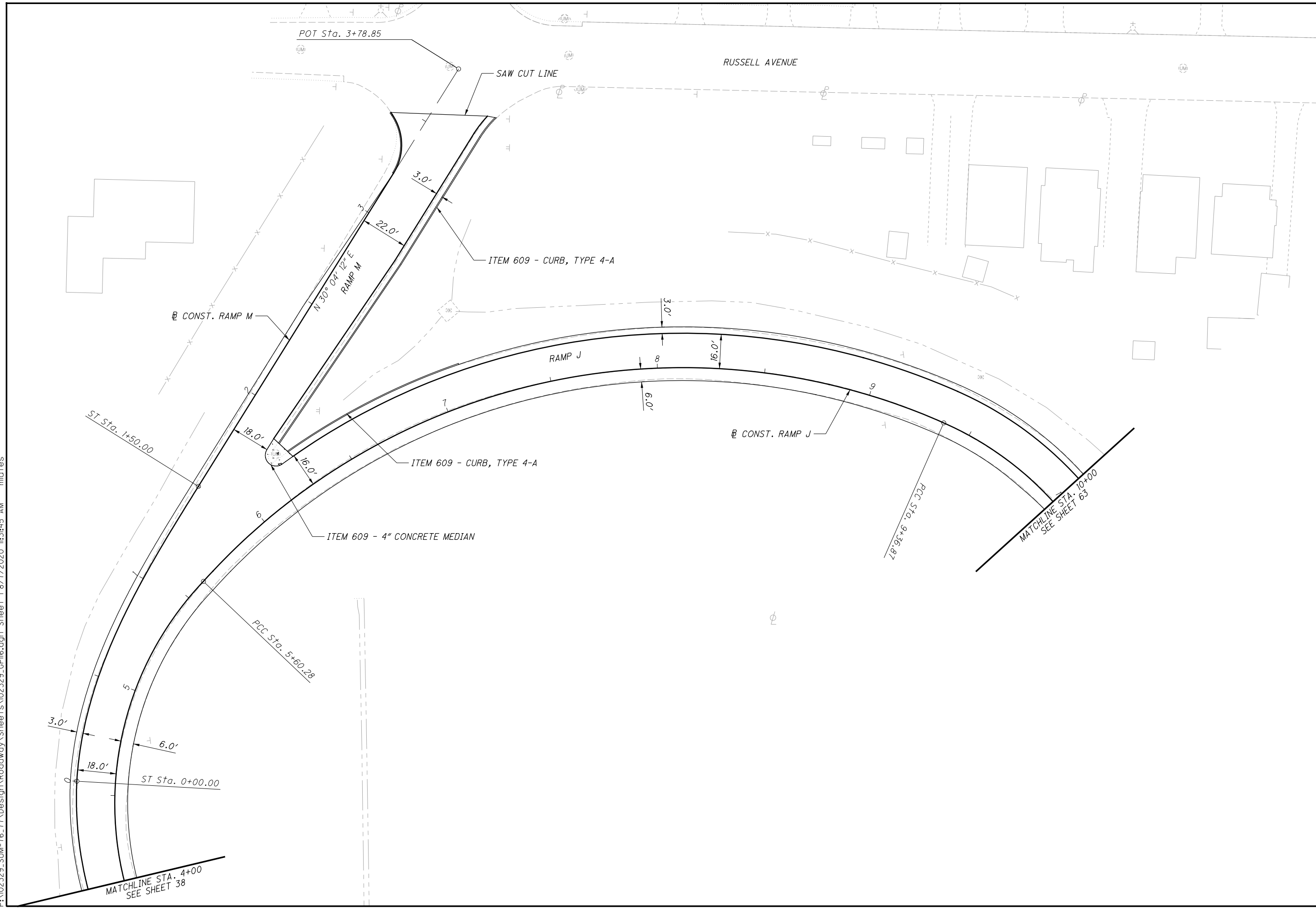

POT Sta. 3+78.85

RUSSELL AVENUE

SAW CUT LINE

ITEM 609 - CURB, TYPE 4-A

CONST. RAMP M

ITEM 609 - 4\"/>

RAMP J

CONST. RAMP J

PCC STA. 9+36.87

MATCHLINE STA. 10+00
SEE SHEET 63

ST Sta. 1+50.00

ST Sta. 0+00.00

MATCHLINE STA. 4+00
SEE SHEET 38

PCC STA. 5+60.28

CALCULATED
MLL
CHECKED
JTW

0 20 40
HORIZONTAL
SCALE IN FEET

PLAN - RAMP J & RAMP M
STA. 4+00 TO STA. 10+00

SUM-76 / 77 / 8-
8.24 / 9.74 / 0.00

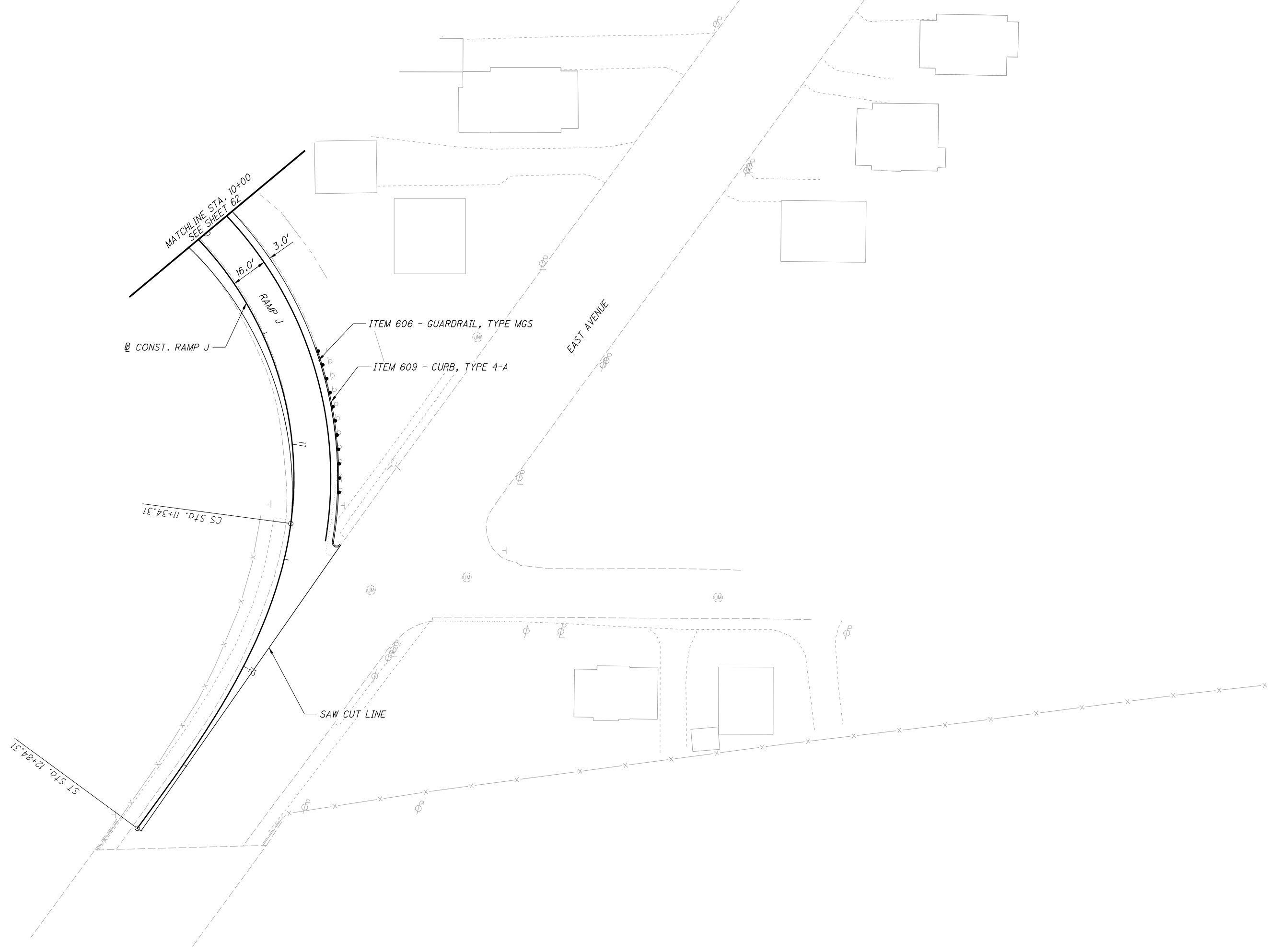

CALCULATED
M.L.L.
CHECKED
J.T.W.

0 20 40
HORIZONTAL
SCALE IN FEET

PLAN - RAMP J
STA. 10+00 TO END WORK

SUM-76 / 77 / 8-
8.24 / 9.74 / 0.00

P:\02329_SUM-76_77\Design\Roadway\Sheets\02329_GPI18.dgn Sheet 1 8/7/2020 11:31:58 AM mlr/tes

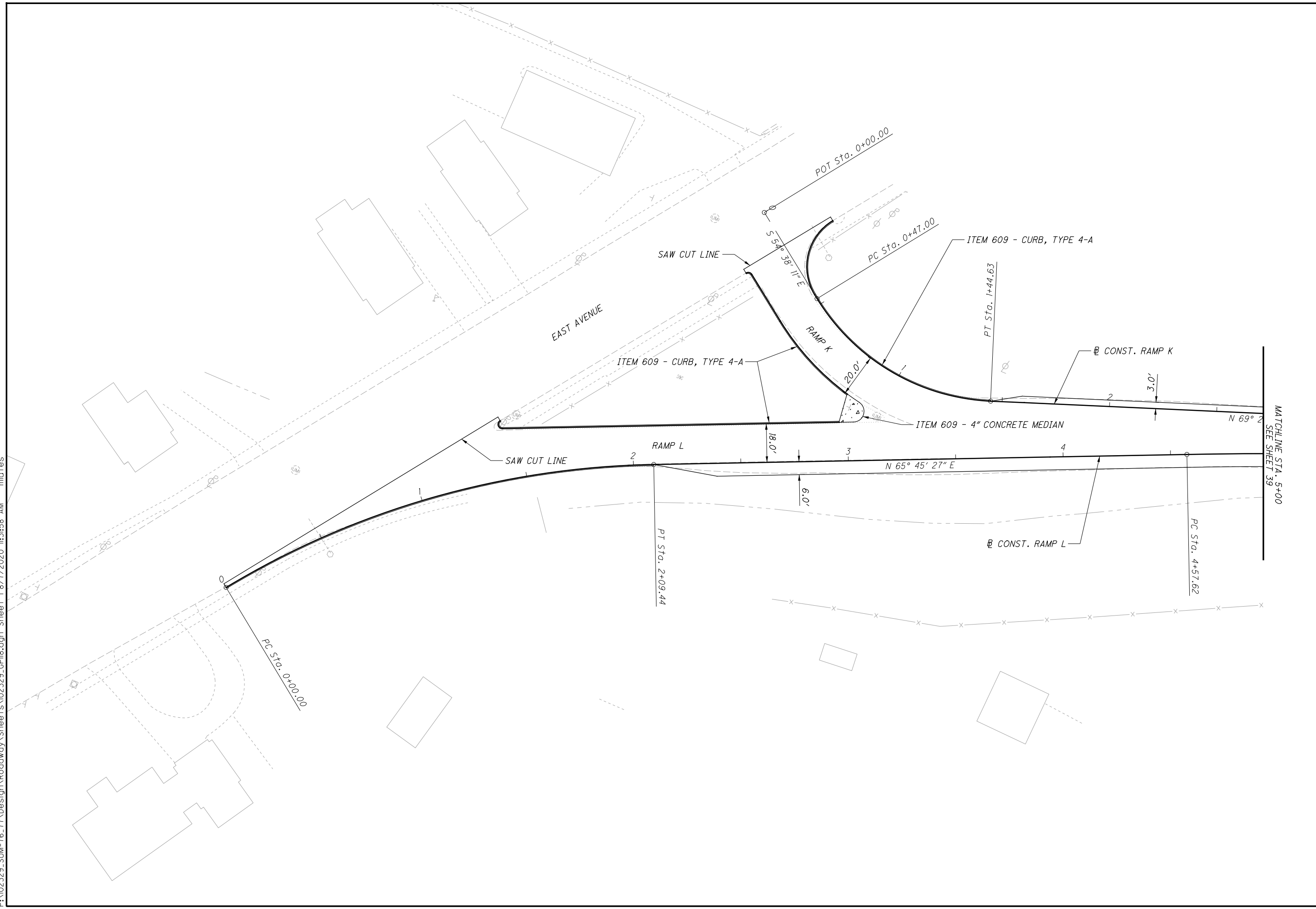

CALCULATED
MLL
CHECKED
JTW

0 20 40
HORIZONTAL
SCALE IN FEET

PLAN - RAMP K & RAMP L
BEGIN WORK TO STA. 5+00

SUM-76 / 77 / 8-
8.24 / 9.74 / 0.00

P:\02329_SUM-76_77\Design\Roadway\Sheets\02329_GP200.dgn Sheet 1 8/11/2020 11:25:04 AM milutes

*FOR RAMP PROFILES AND PAVEMENT CROSS SLOPES SEE THE SUM-77/277/224-VARIOUS PLAN SET.

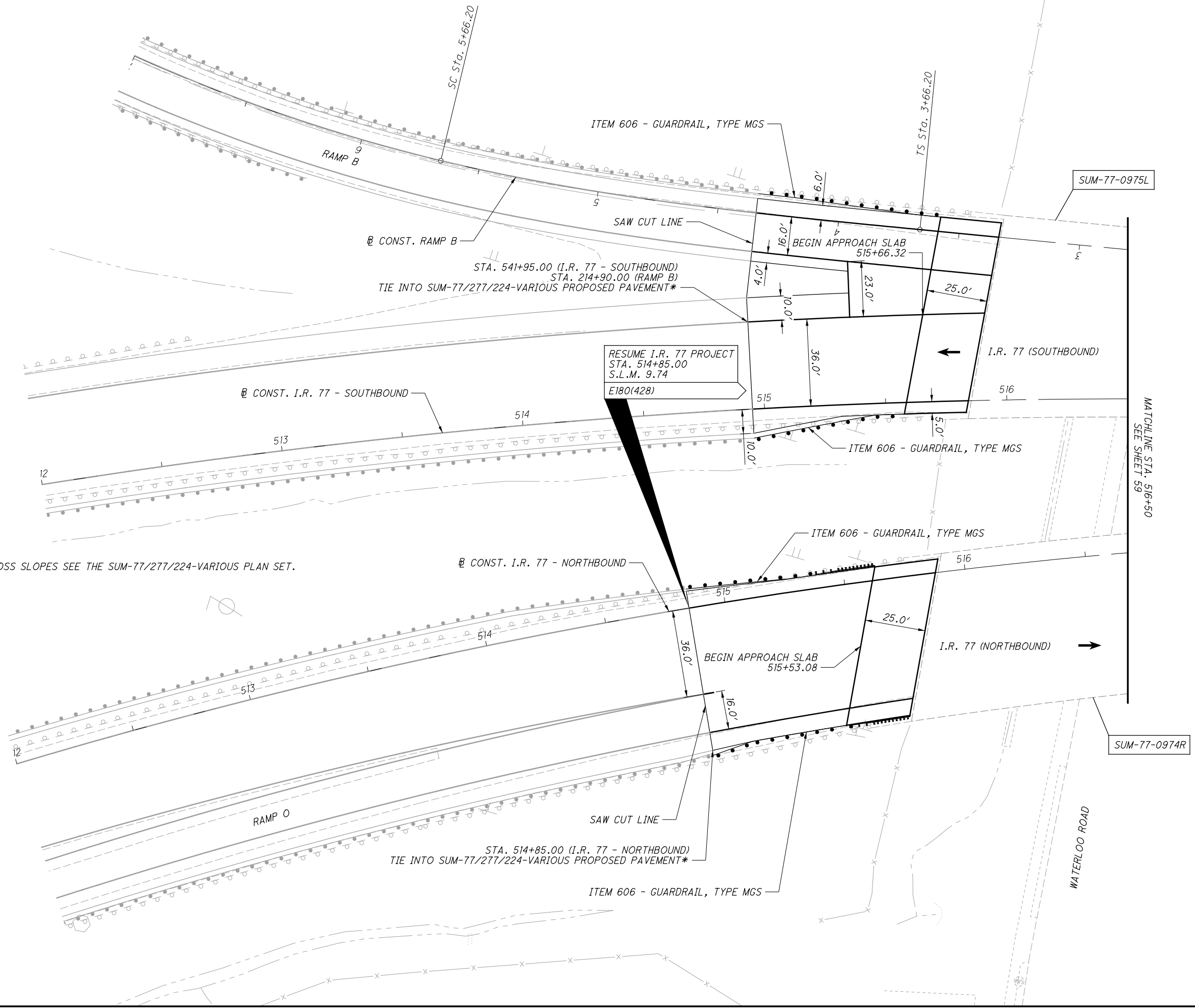

CALCULATED
M.L.L.
CHECKED
J.T.W.

0 20 40
HORIZONTAL
SCALE IN FEET

PLAN - I.R. 77
BEGIN I.R. 77 PROJECT TO STA. 516+50

SUM-76 / 77 / 8-
8.24 / 9.74 / 0.00

P:\02329_SUM-76_77\Design\Roadway\Sheets\02329_GP201.dgn Sheet 1 8/18/2020 11:41:15 AM milutes



CALCULATED MLL CHECKED JTJ

PLAN - I.R. 77
STA. 516+50 TO STA. 522+00

SUM-76/77/8-
8.24/9.74/0.00

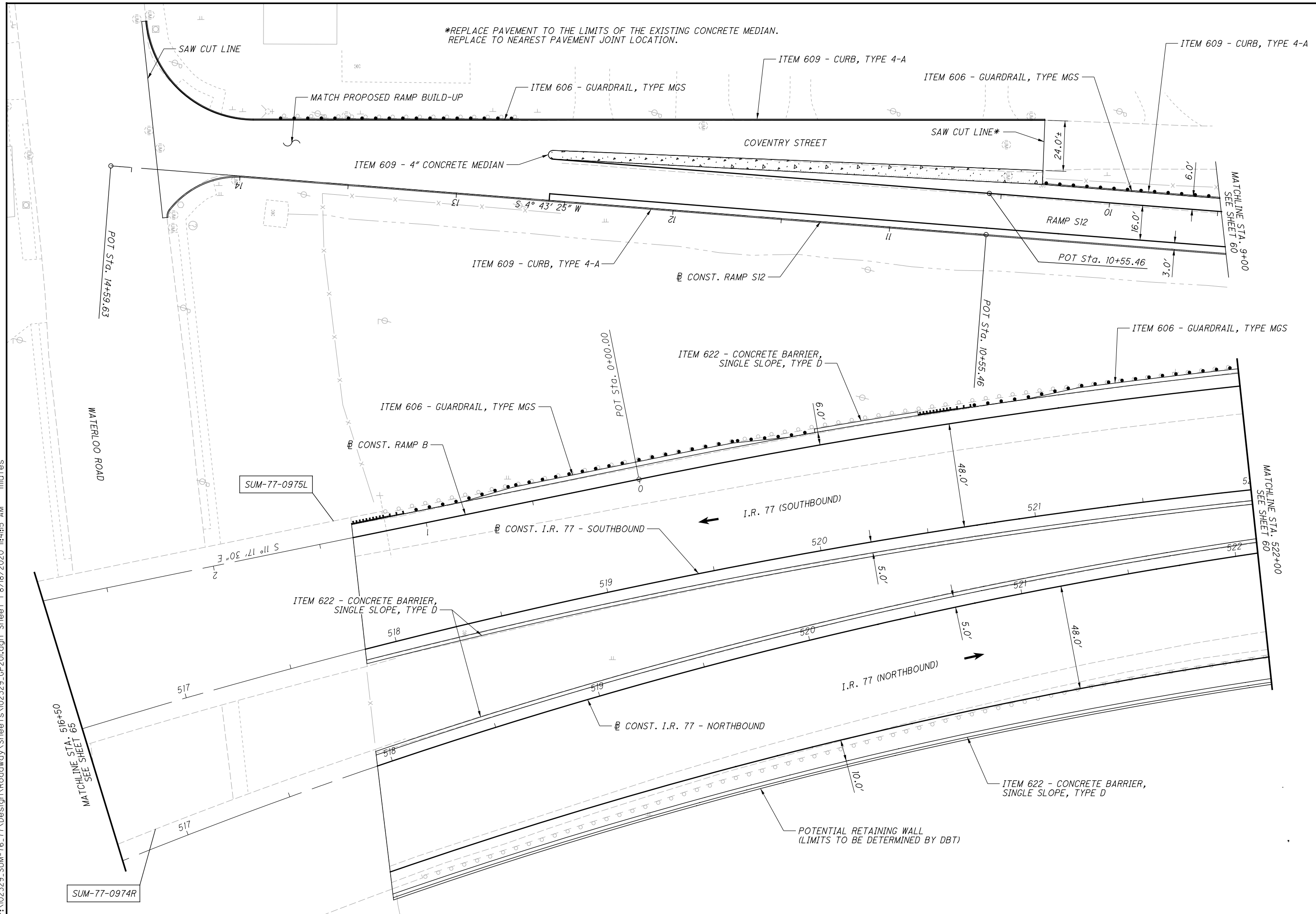

P:\102329_SUM-76_77\Design\Roadway\Sheets\102329_GP202.dgn Sheet 1 8/7/2020 11:32:09 AM mlutes

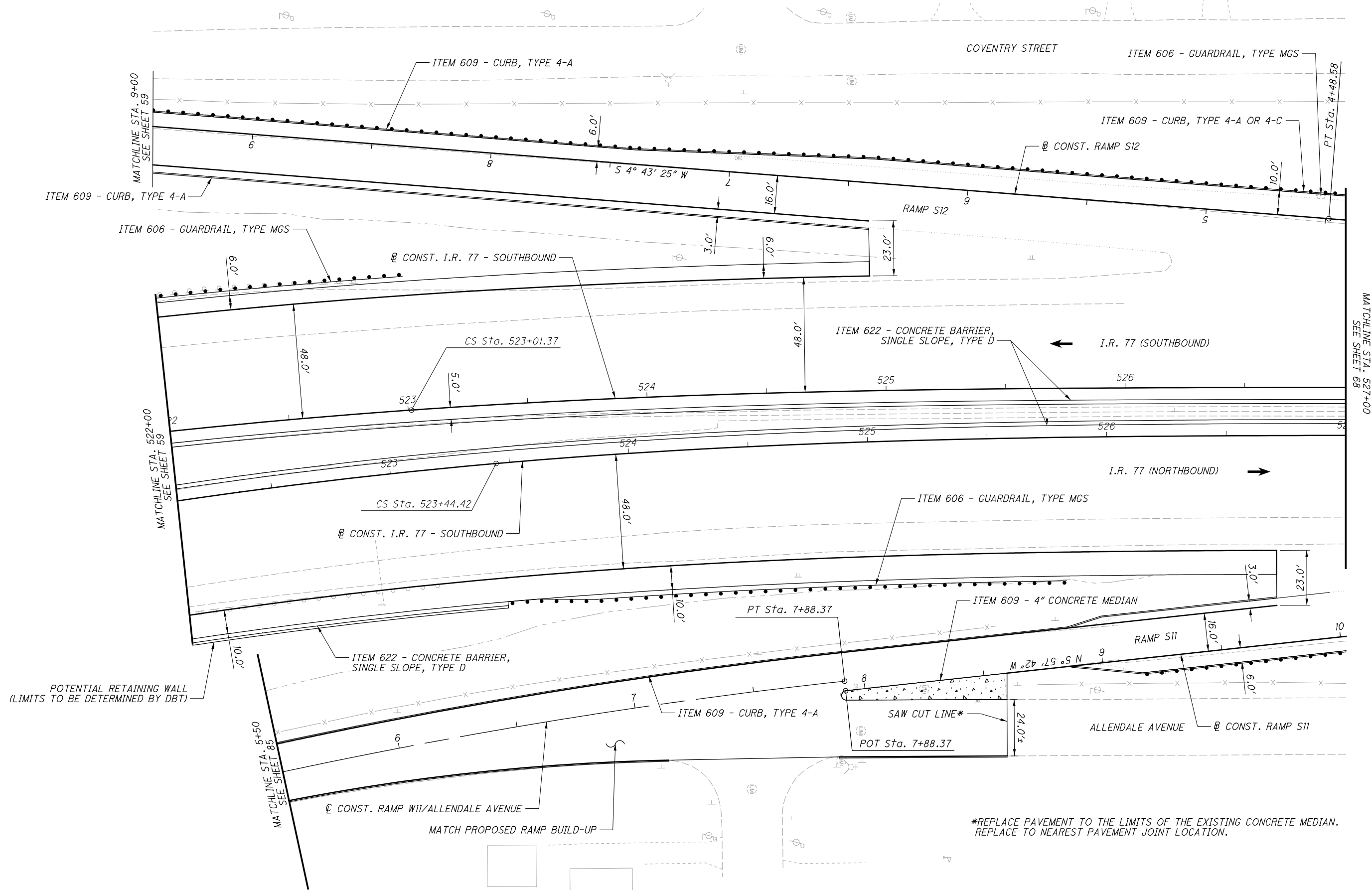

POTENTIAL RETAINING WALL
(LIMITS TO BE DETERMINED BY DBT)

*REPLACE PAVEMENT TO THE LIMITS OF THE EXISTING CONCRETE MEDIAN.
REPLACE TO NEAREST PAVEMENT JOINT LOCATION.





 HORIZONTAL SCALE IN FEET

CALCULATED

MLL

CHECKED

JTW

PLAN - I.R. 77
STA. 522+00 TO STA. 527+00

SUM-76 / 77 / 8-
8.24 / 9.74 / 0.00

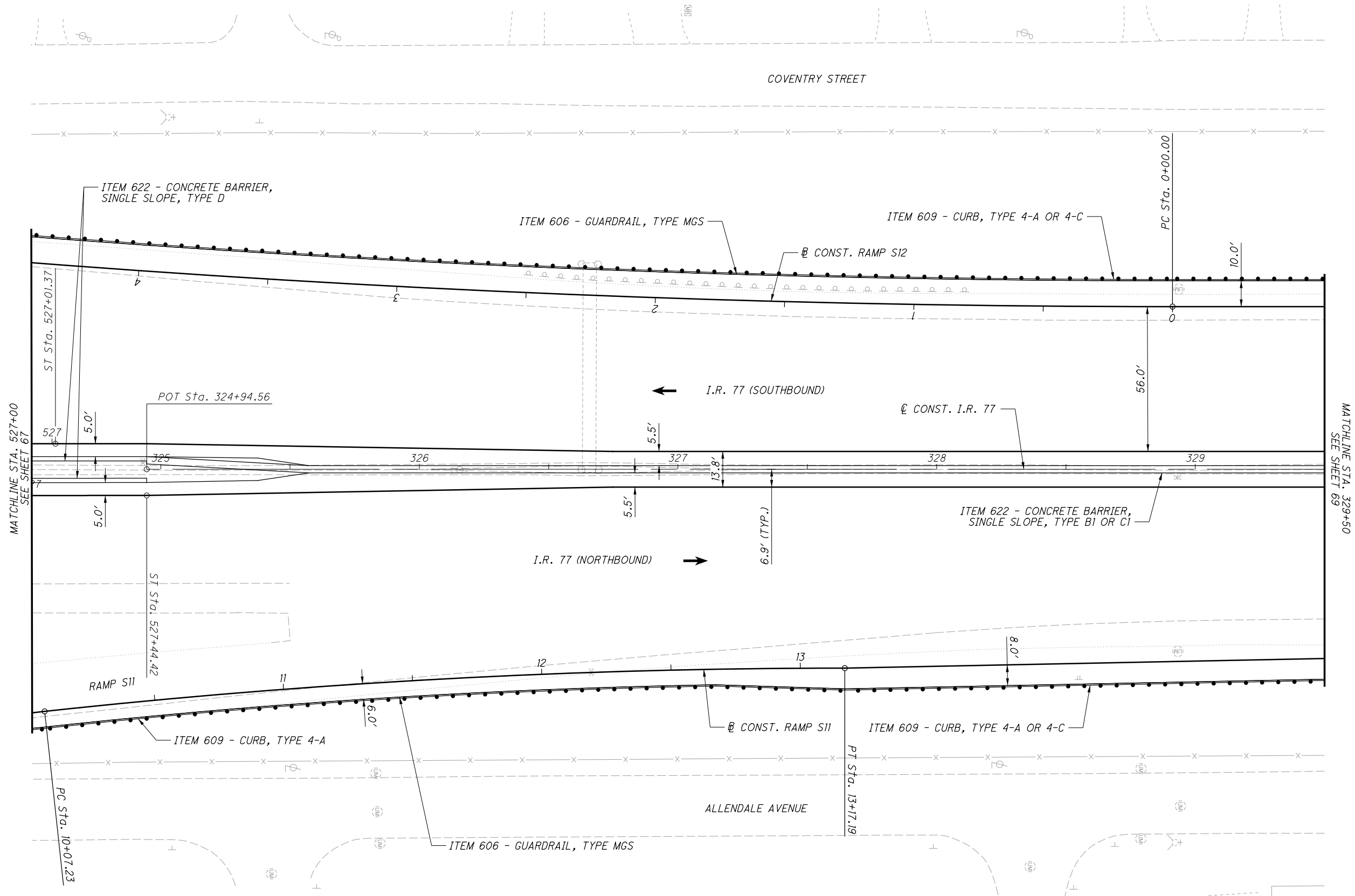

CALCULATED
M.L.L.
CHECKED
J.T.W.

0 10 20 40
HORIZONTAL
SCALE IN FEET

PLAN - I.R. 77
STA. 527+00 TO STA. 329+50

P:\02329_SUM-76_77\Design\Roadway\Sheets\02329_GP204.dgn Sheet 1 8/7/2020 11:32:11 AM mlutes

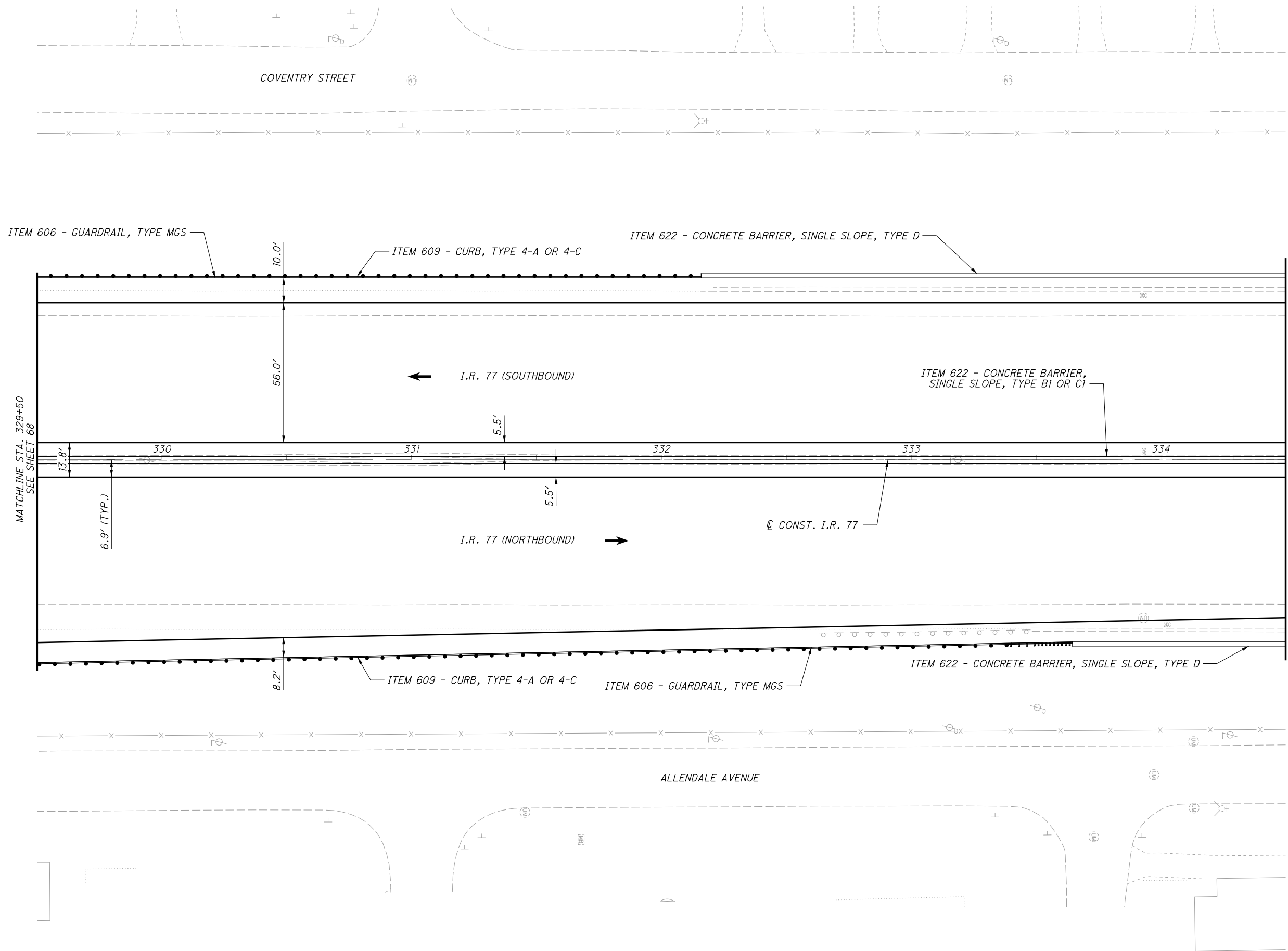

CALCULATED
M.L.L.
CHECKED
J.T.W.

PLAN - I.R. 77
STA. 329+50 TO STA. 334+50

SUM-76 / 77 / 8-
8.24 / 9.74 / 0.00

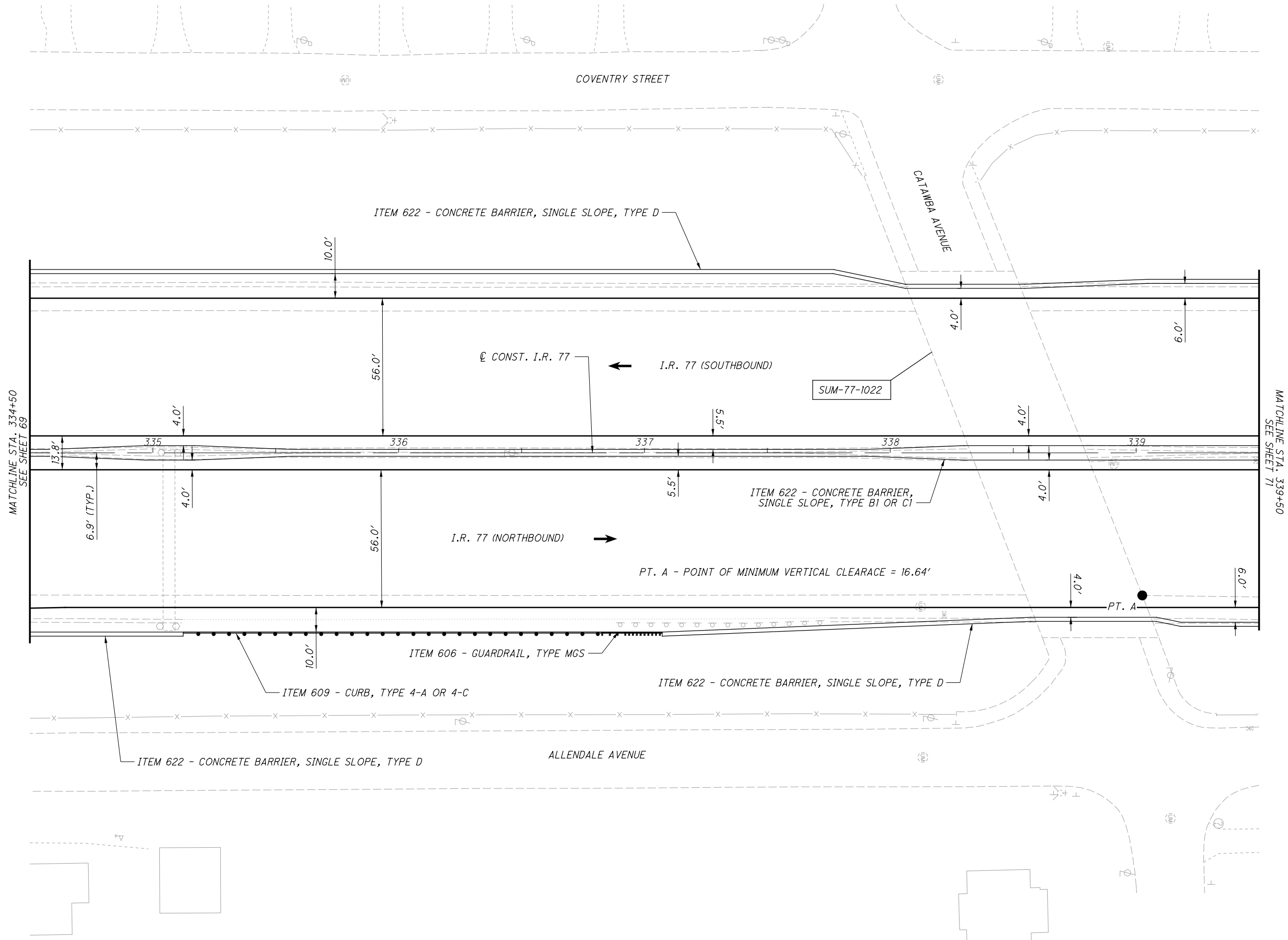

CALCULATED
M.L.L.
CHECKED
J.T.W.

PLAN - I.R. 77
STA. 334+50 TO STA. 339+50

SUM-76 / 77 / 8-
8.24 / 9.74 / 0.00

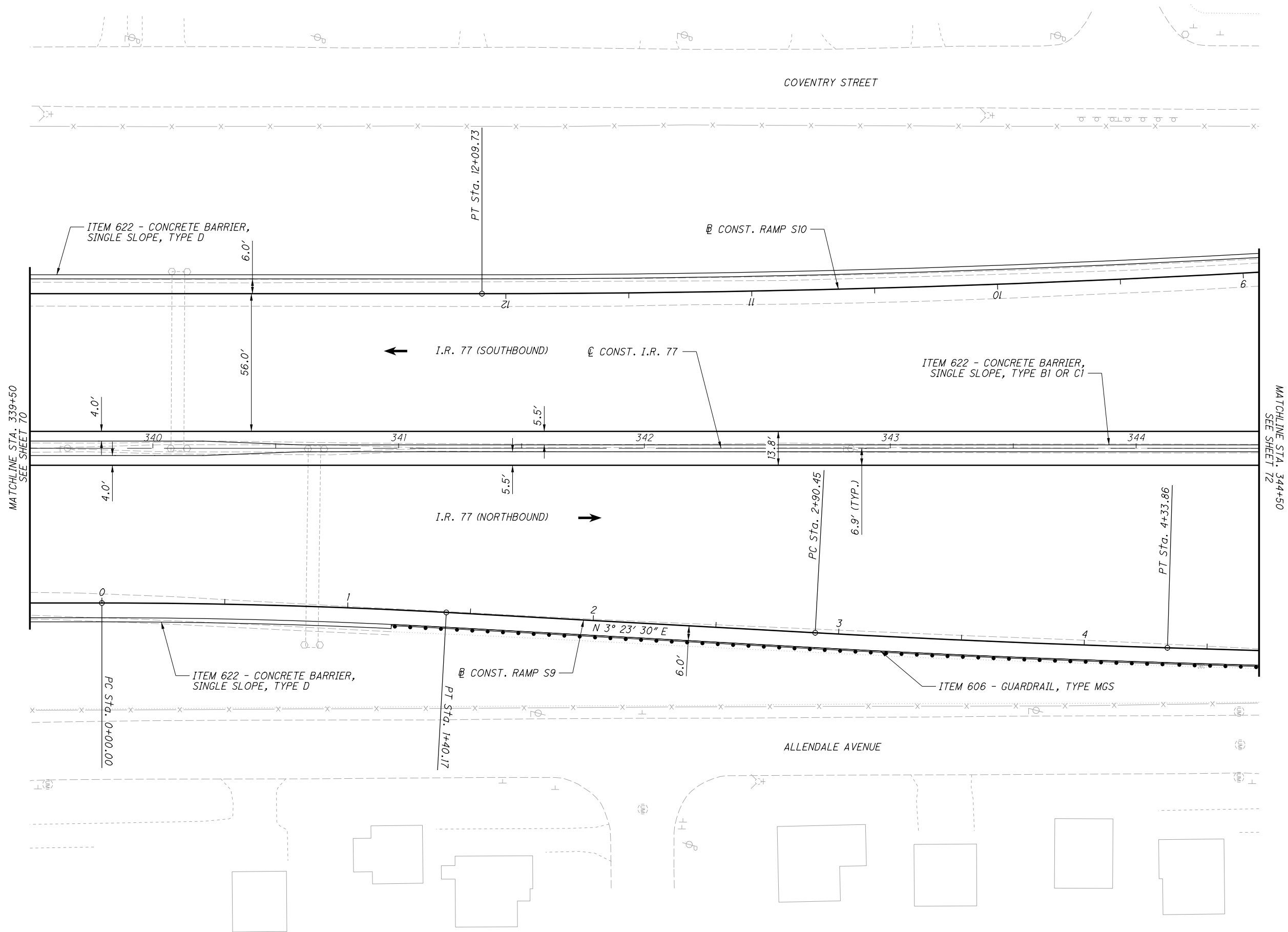

CALCULATED
M.L.L.
CHECKED
J.T.W.

PLAN - I.R. 77
STA. 339+50 TO STA. 344+50

SUM-76 / 77 / 8-
8.24 / 9.74 / 0.00

P:\102329_SUM-76_77\Design\Roadway\Sheets\102329_GP207.dgn Sheet 1 8/7/2020 11:32:15 AM mlutes

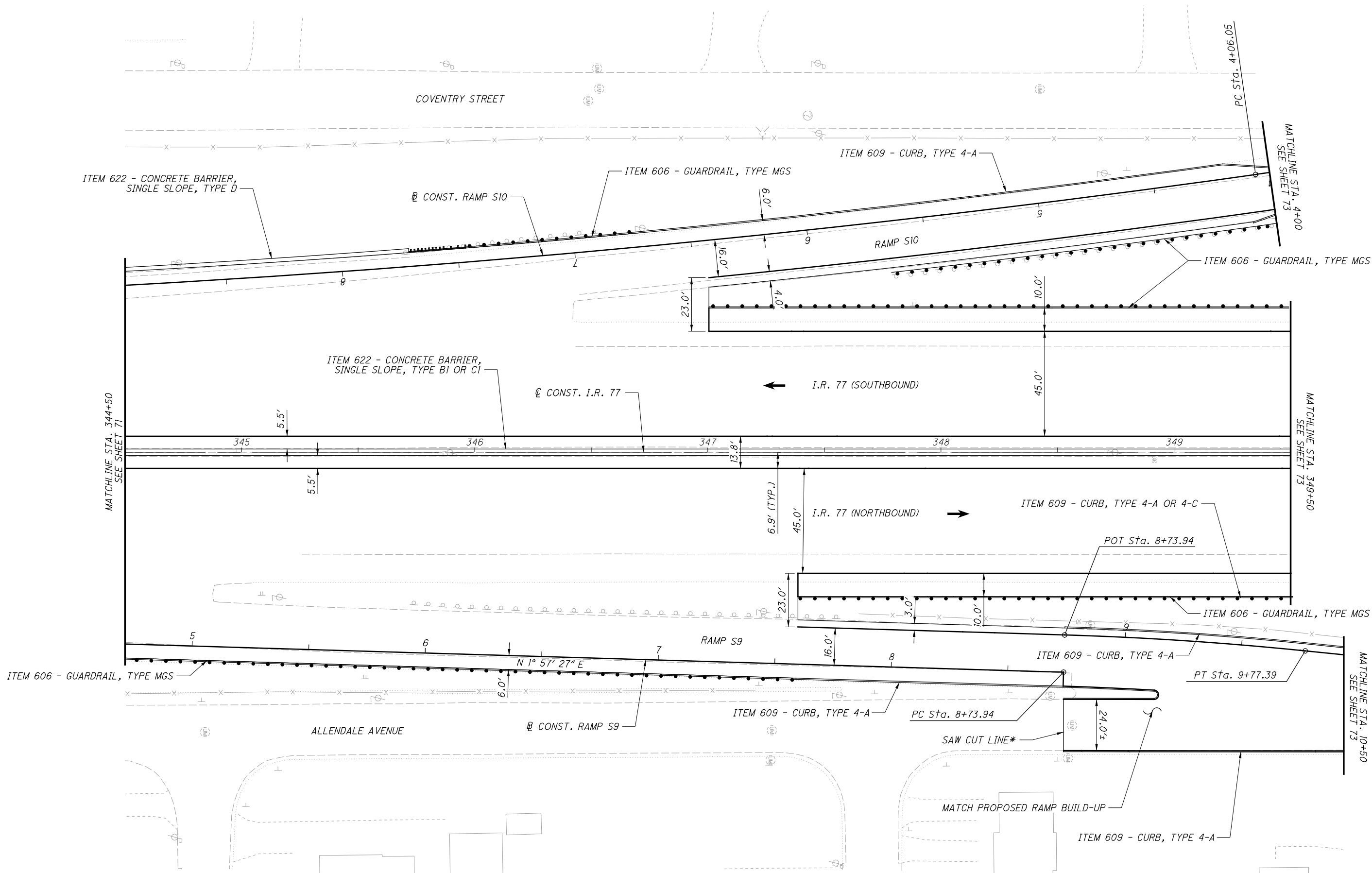





 0 10 20 30 40

 HORIZONTAL SCALE IN FEET

CALCULATED MLL CHECKED JTJ

PLAN - I.R. 77

STA. 344+50 TO STA. 349+50

SUM-76 / 77 / 8-

8.24 / 9.74 / 0.00





P:\102329_SUM-76_77\Design\Roadway\Sheets\102329_GP208.dgn Sheet 1 8/7/2020 11:32:16 AM milutes

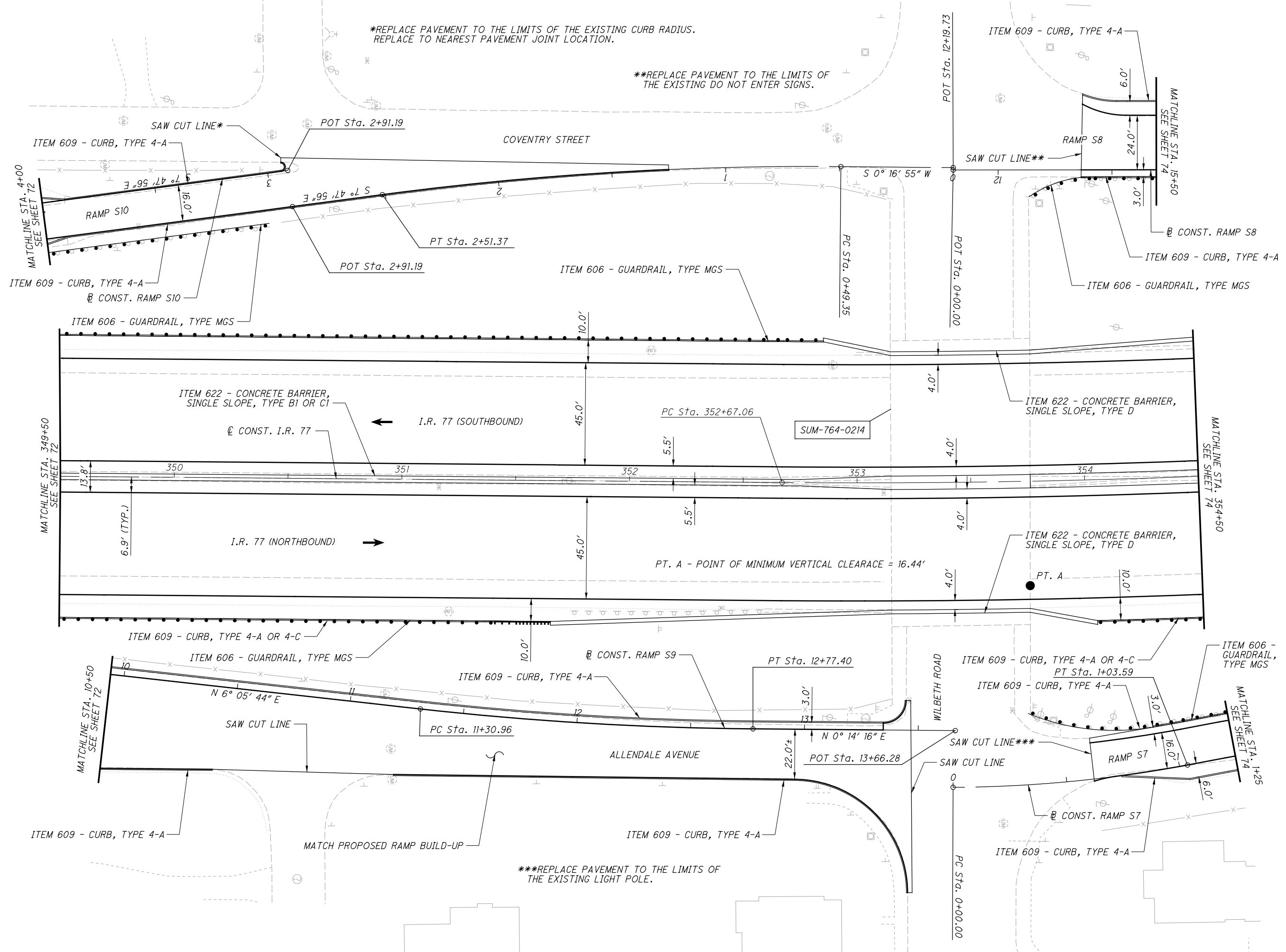

CALCULATED
MILL
CHECKED
JTW

0 20 40
HORIZONTAL
SCALE IN FEET

PLAN - I.R. 77
STA. 349+50 TO STA. 354+50

SUM-76 / 77 / 8 -
8.24 / 9.74 / 0.00

73
138

P:\02329_SUM-76_77\Design\Roadway\Sheets\02329_GP209.dgn Sheet 1 8/7/2020 11:32:17 AM mlutes

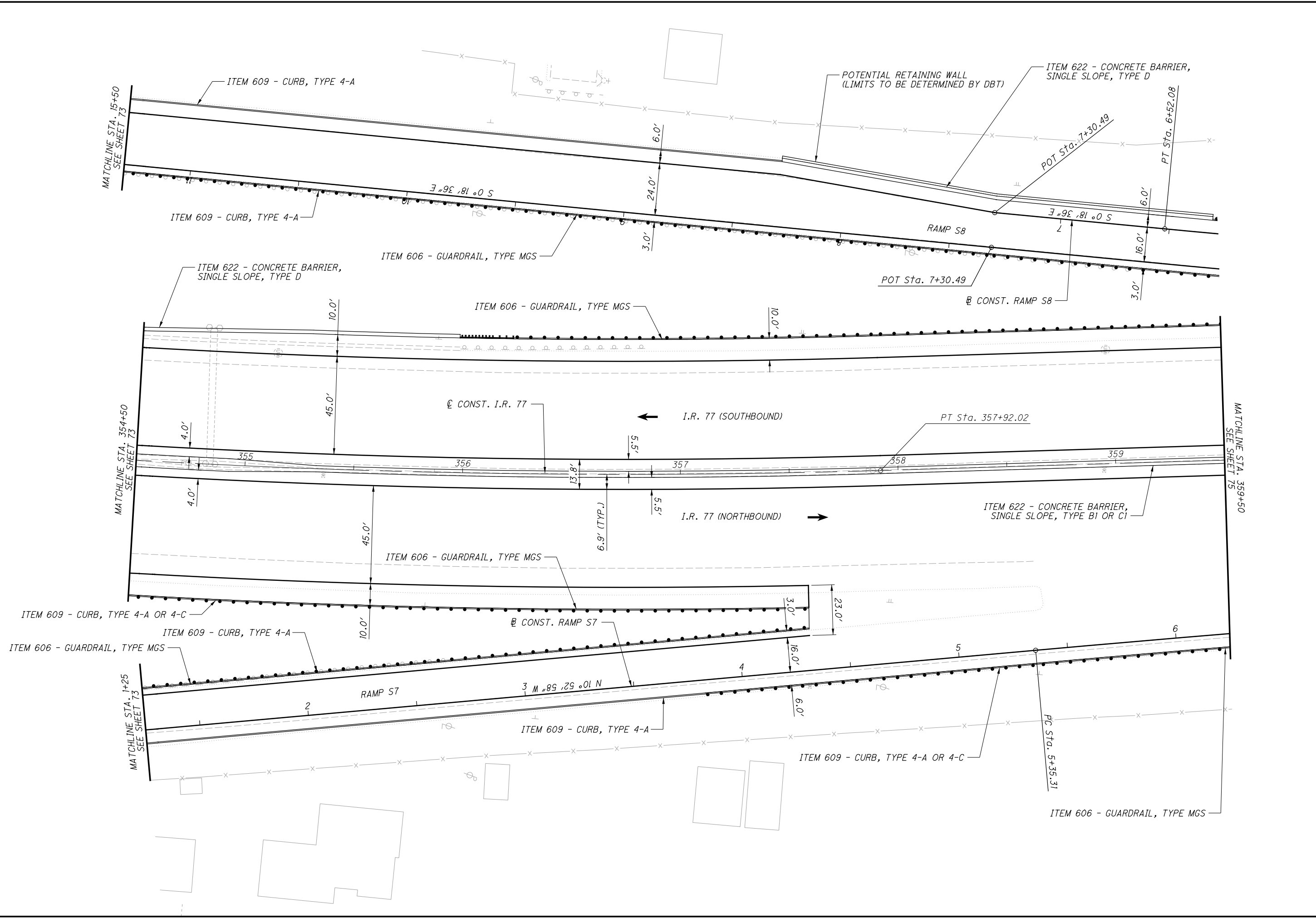

CALCULATED
 MLL
 CHECKED
 JTJ

0 20 40
 HORIZONTAL
 SCALE IN FEET

PLAN - I.R. 77
STA. 354+50 TO STA. 359+50

SUM-76 / 77 / 8-
8.24 / 9.74 / 0.00

P:\02329_SUM-76_77\Design\Roadway\Sheets\02329_GP210.dgn Sheet 1 8/7/2020 11:32:18 AM milutes

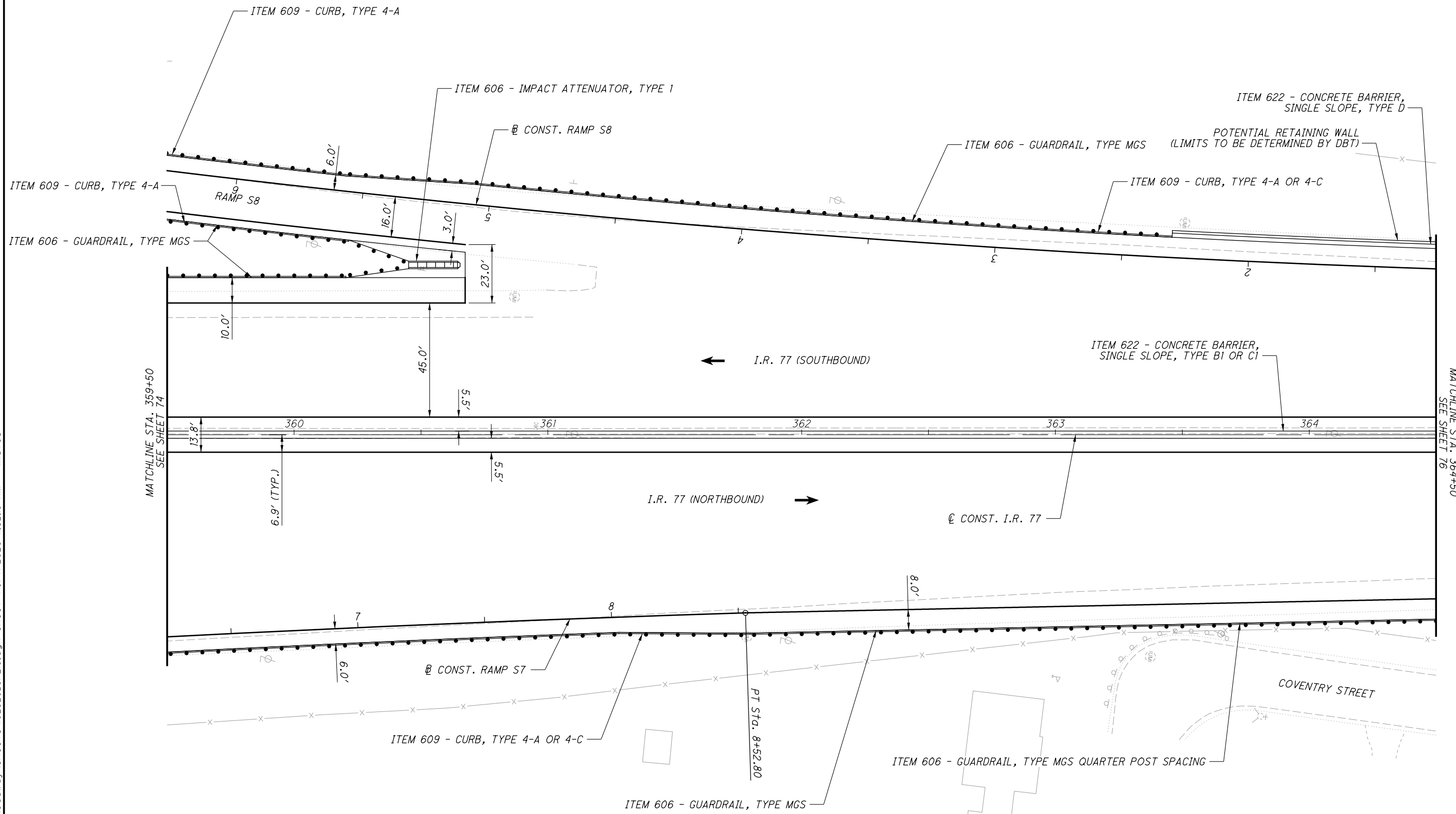

MATCHLINE STA. 359+50
SEE SHEET 74

MATCHLINE STA. 364+50
SEE SHEET 76

CALCULATED MLL CHECKED JTJW

0 20 40
HORIZONTAL SCALE IN FEET

N

PLAN - I.R. 77

STA. 359+50 TO STA. 364+50

SUM-76 / 77 / 8-

8.24 / 9.74 / 0.00

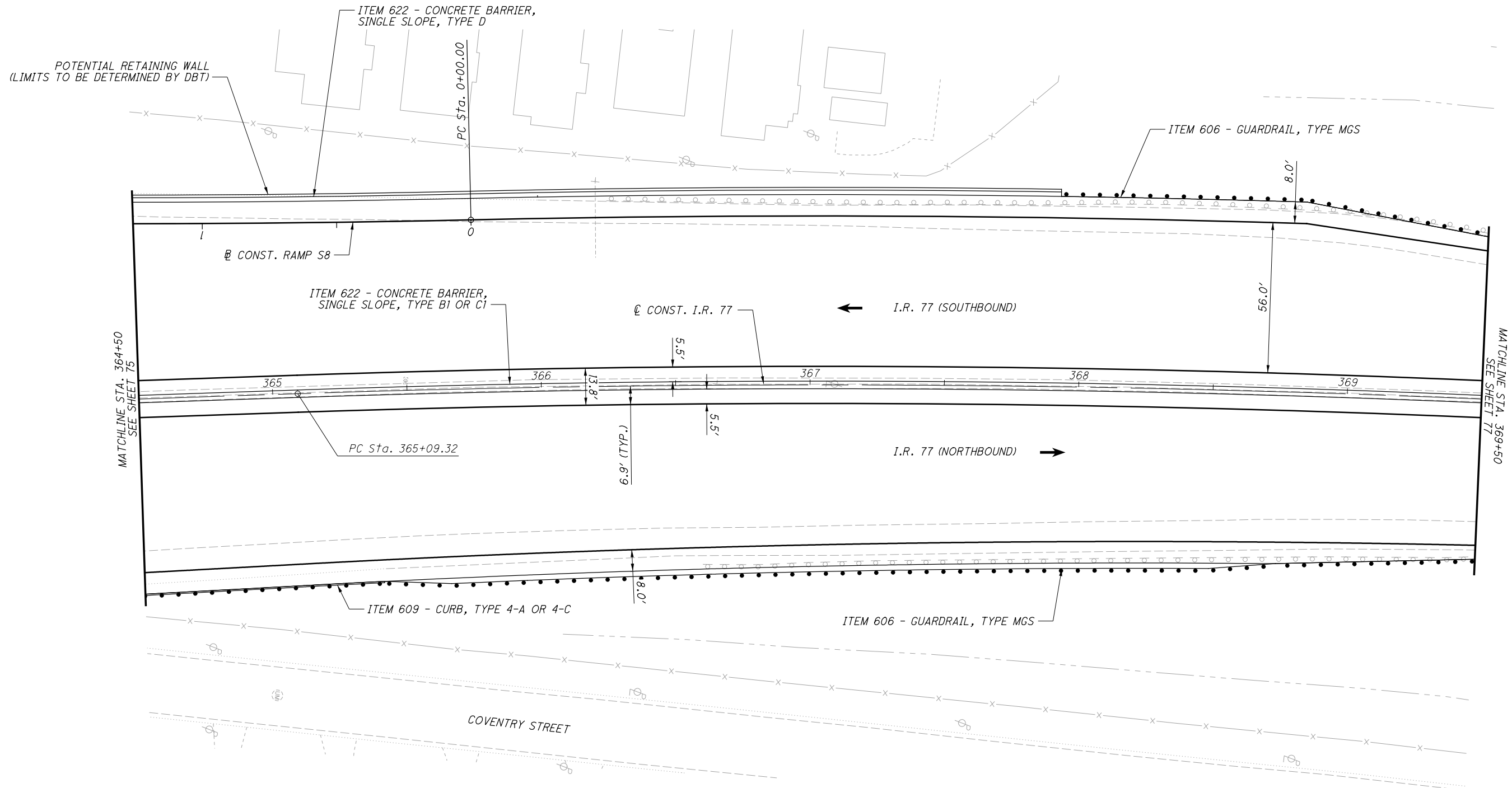

CALCULATED
MLL
CHECKED
JTW

0 20 40
HORIZONTAL
SCALE IN FEET

PLAN - I.R. 77
STA. 364+50 TO STA. 369+50

SUM-76 / 77 / 8-
8.24 / 9.74 / 0.00

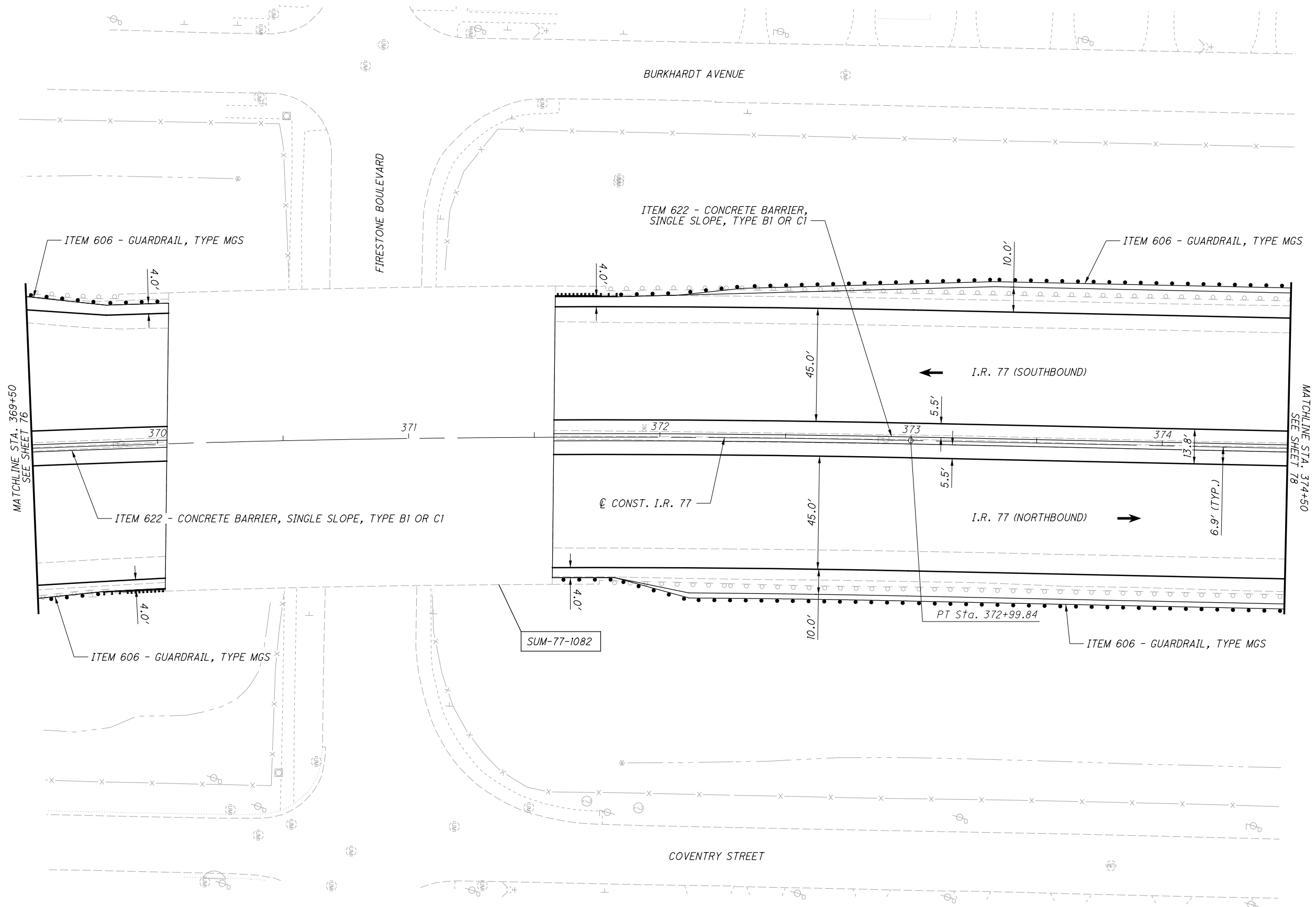

CALCULATED
MLL
CHECKED
JTW

0 20 40
HORIZONTAL
SCALE IN FEET

PLAN - I.R. 77
STA. 369+50 TO STA. 374+50

SUM-76 / 77 / 8-
8.24 / 9.74 / 0.00

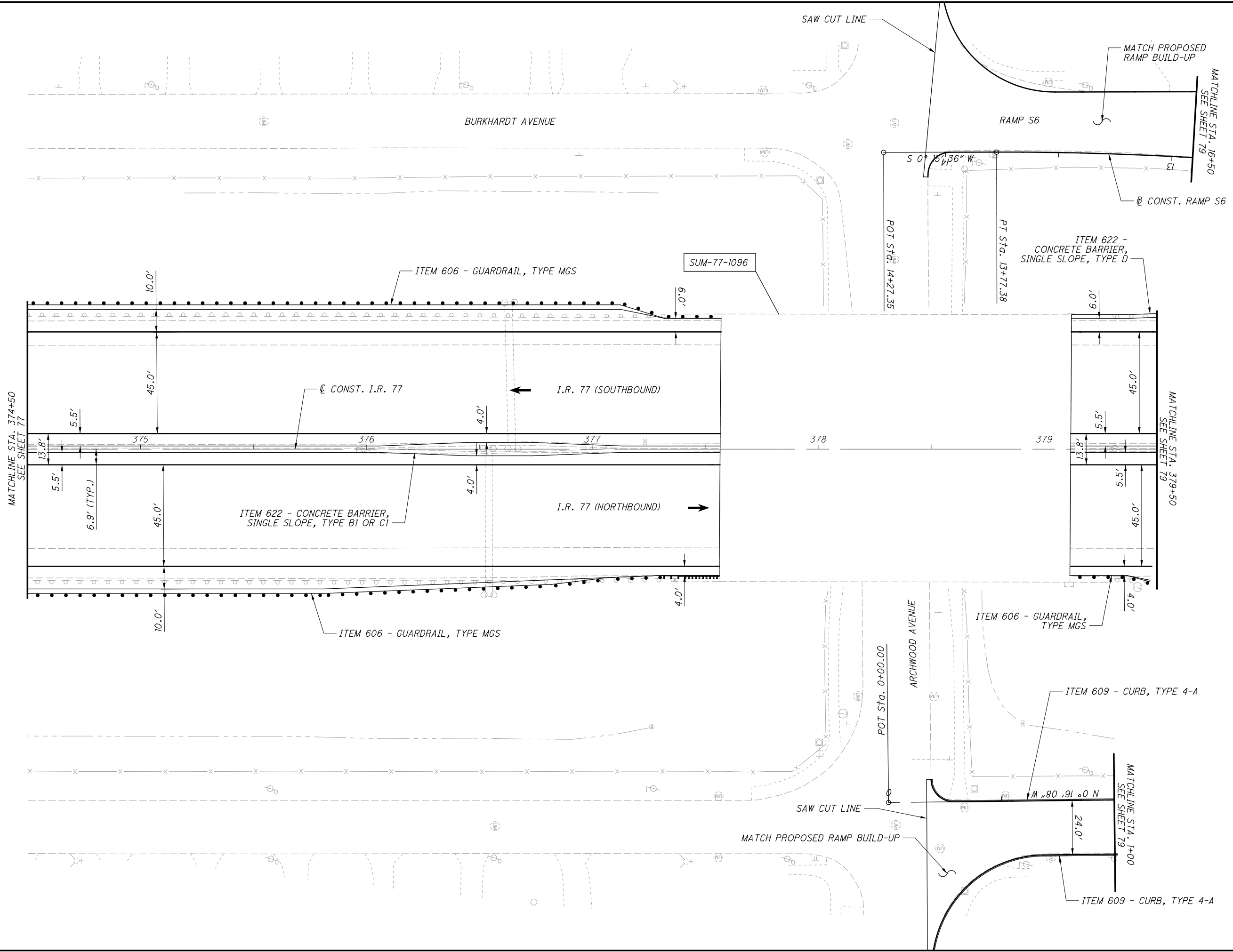

CALCULATED
 MLL
 CHECKED
 JTW

PLAN - I.R. 77
STA. 374+50 TO STA. 379+50

SUM-76 / 77 / 8-
8.24 / 9.74 / 0.00

P:\02329_SUM-76_77\Design\Roadway\Sheets\02329_GP214.dgn Sheet 1 8/18/2020 11:48:21AM mlr/tes

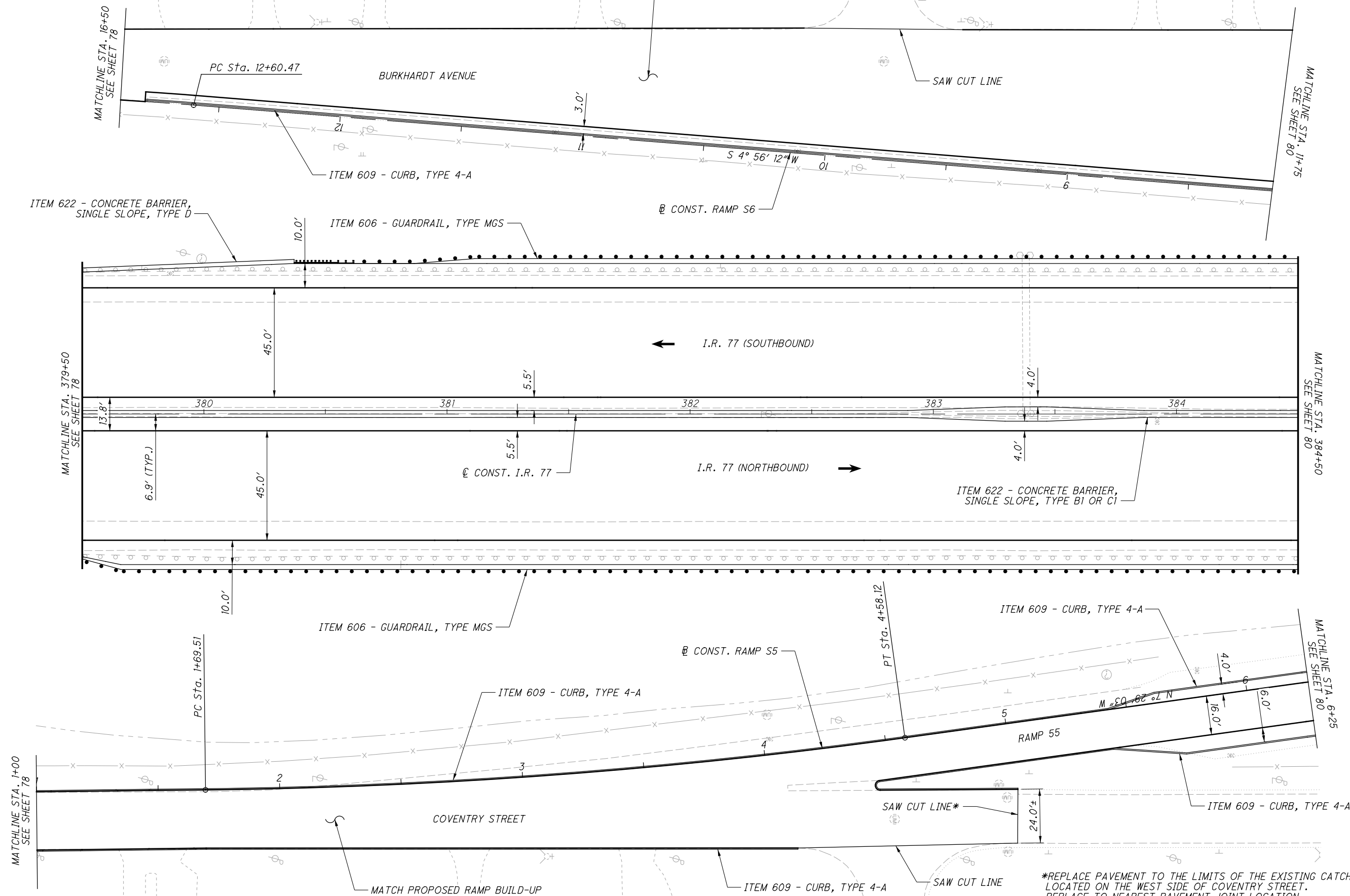

*REPLACE PAVEMENT TO THE LIMITS OF THE EXISTING CATCHBASIN LOCATED ON THE WEST SIDE OF COVENTRY STREET. REPLACE TO NEAREST PAVEMENT JOINT LOCATION.





 HORIZONTAL SCALE IN FEET

CALCULATED	MLL
CHECKED	JTW

PLAN - I.R. 77
STA. 379+50 TO STA. 384+50

SUM-76 / 77 / 8-
8.24 / 9.74 / 0.00

P:\02329_SUM-76_77\Design\Roadway\Sheets\02329_GP215.dgn Sheet 1 8/18/2020 11:48:22 AM mlutes

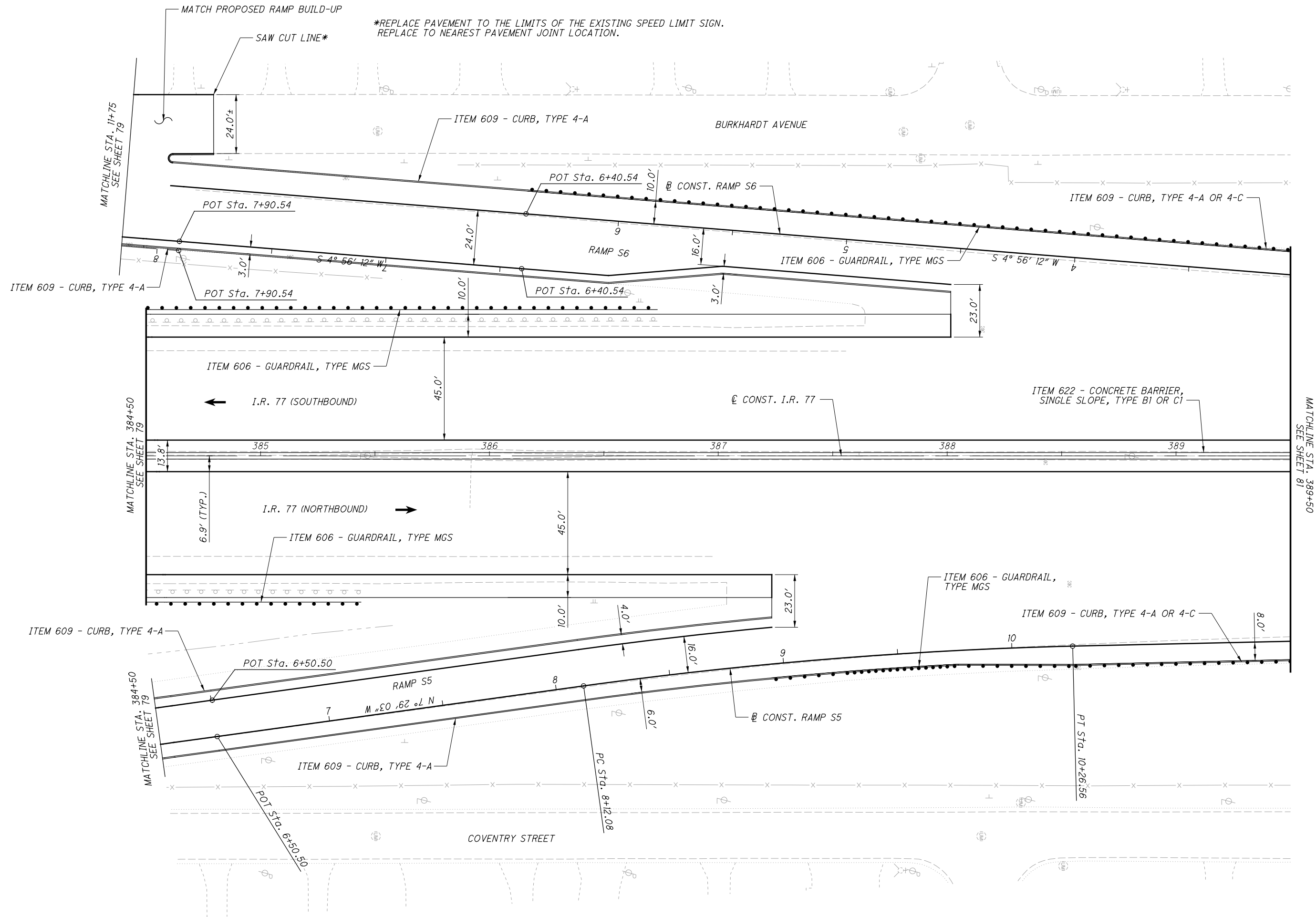

*REPLACE PAVEMENT TO THE LIMITS OF THE EXISTING SPEED LIMIT SIGN.
REPLACE TO NEAREST PAVEMENT JOINT LOCATION.



CALCULATED
M.L.L.
CHECKED
J.T.W.

PLAN - I.R. 77
STA. 384+50 TO STA. 389+50

SUM-76 / 77 / 8-
8.24 / 9.74 / 0.00

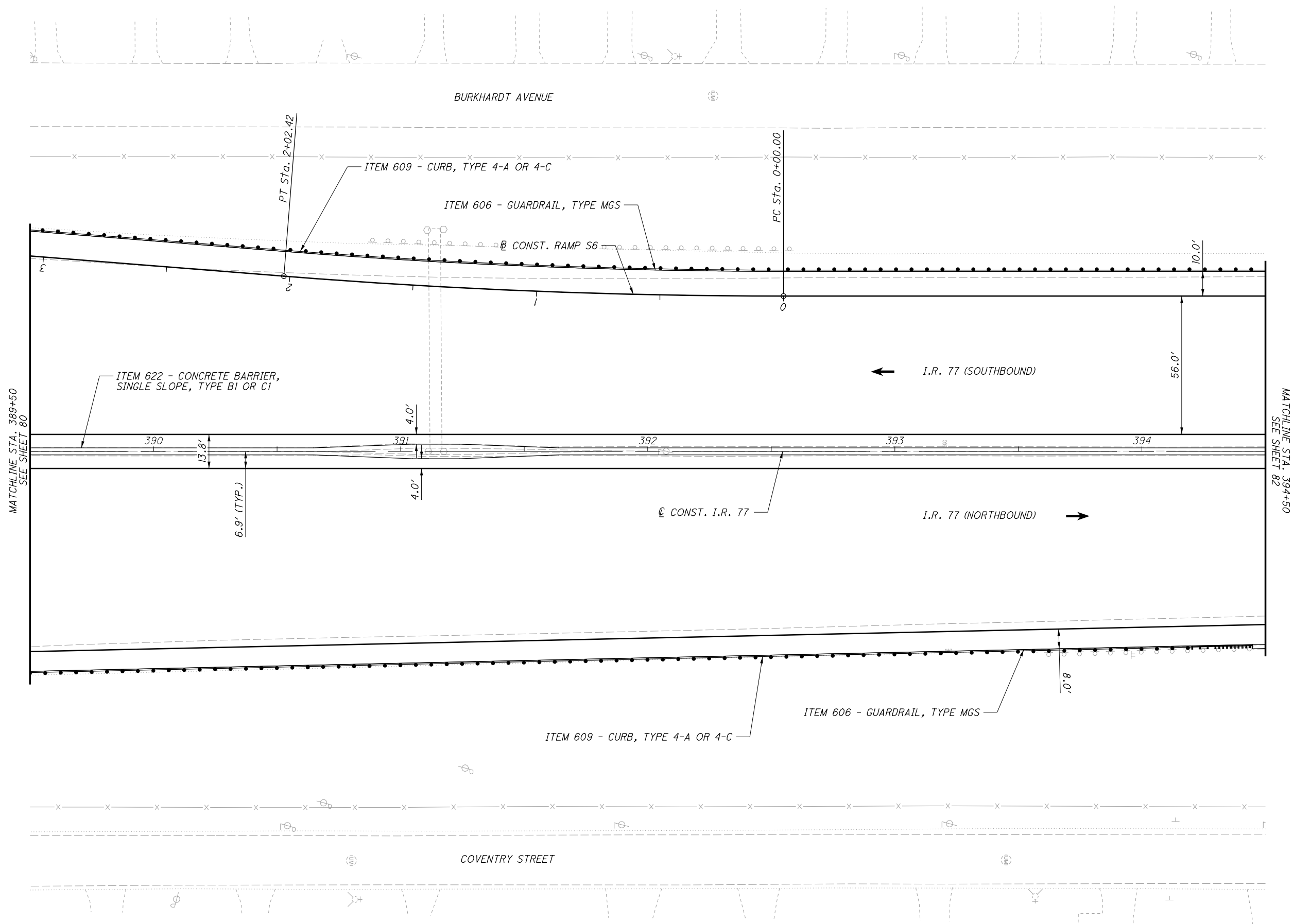

CALCULATED
M.L.L.
CHECKED
J.T.W.

0 20 40
HORIZONTAL
SCALE IN FEET

PLAN - I.R. 77
STA. 389+50 TO STA. 394+50

SUM-76 / 77 / 8-
8.24 / 9.74 / 0.00

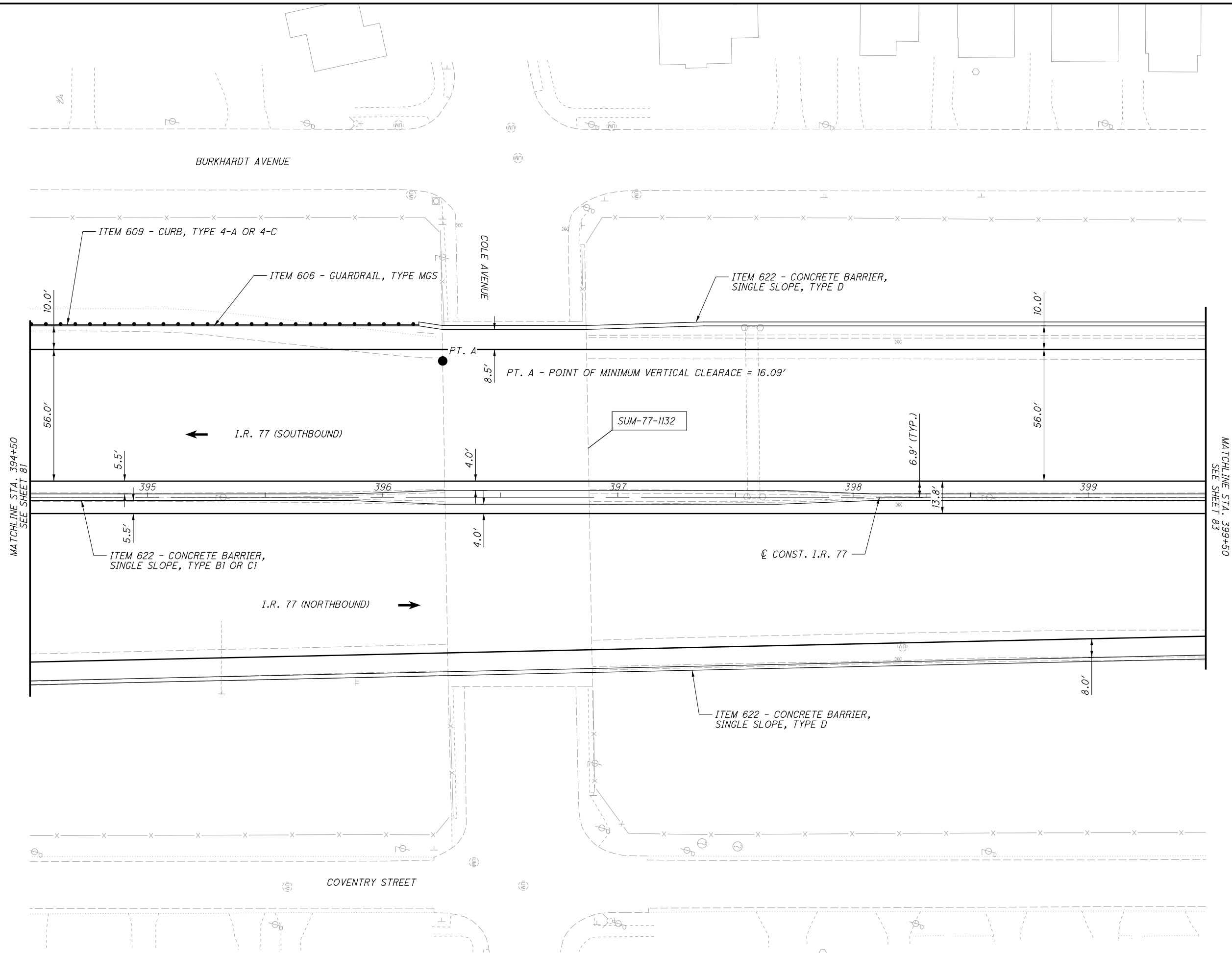

CALCULATED
 MLL
 CHECKED
 JTJ

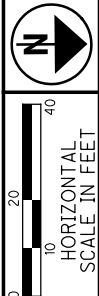

PLAN - I.R. 77
STA. 394+50 TO STA. 399+50

SUM-76 / 77 / 8-
8.24 / 9.74 / 0.00

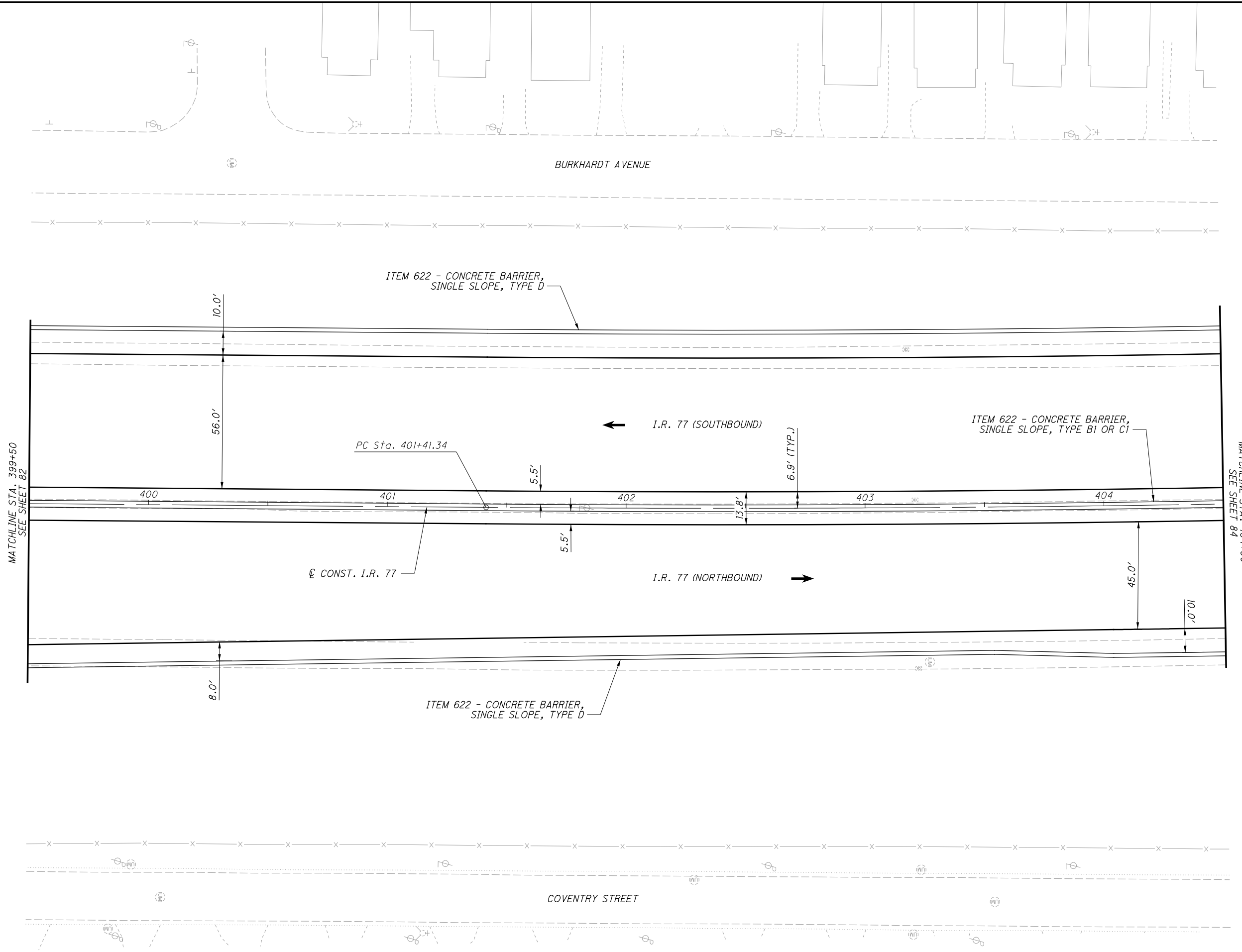

CALCULATED
 MILL
 CHECKED
 JTJ

0 20 40
 HORIZONTAL
 SCALE IN FEET

N

PLAN - I.R. 77
STA. 399+50 TO STA. 404+50

SUM-76 / 77 / 8-
8.24 / 9.74 / 0.00

NOTES:

1. FOR DETAILS REGARDING THE SUM-76/77/8-10.99/11.54/0.00 PROJECT SEE ATTACHMENT C.



CALCULATED
M.L.L.
CHECKED
J.T.W.

PLAN - I.R. 77 / S.R. 8
STA. 404+50 TO STA. 4294+50

SUM-76 / 77 / 8-
8.24 / 9.74 / 0.00

P:\02329_SUM-76_77\Design\Roadway\Sheets\02329_GP219.dgn Sheet 1 8/7/2020 11:32:38 AM mlutes

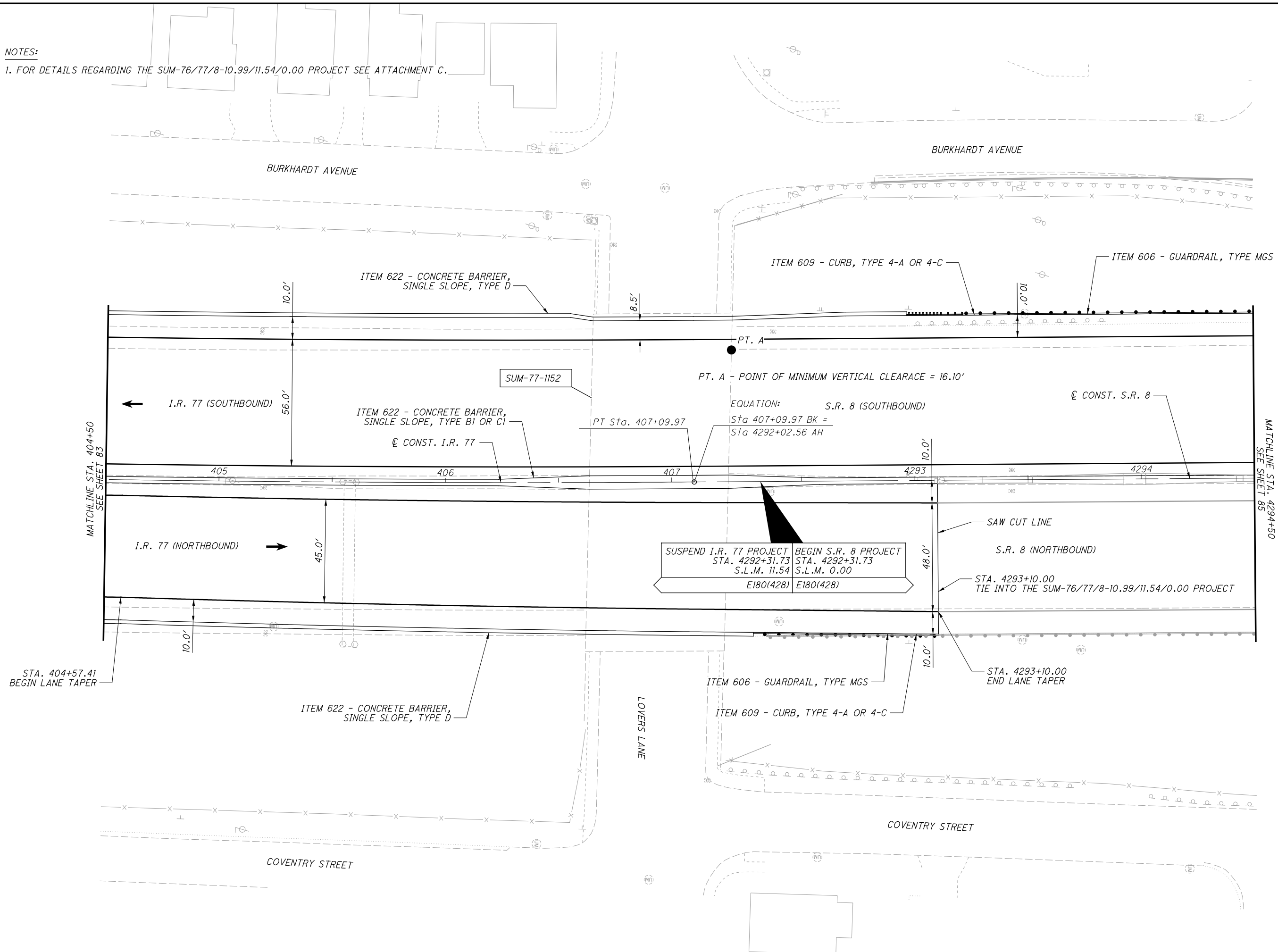

MATCHLINE STA. 404+50
SEE SHEET 83

MATCHLINE STA. 4294+50
SEE SHEET 85

SUSPEND I.R. 77 PROJECT STA. 4292+31.73 S.L.M. 11.54	BEGIN S.R. 8 PROJECT STA. 4292+31.73 S.L.M. 0.00
E180(428)	E180(428)

EQUATION: S.R. 8 (SOUTHBOUND)
Sta 407+09.97 BK =
Sta 4292+02.56 AH

PT. A - POINT OF MINIMUM VERTICAL CLEARANCE = 16.10'

SAW CUT LINE
S.R. 8 (NORTHBOUND)
STA. 4293+10.00
TIE INTO THE SUM-76/77/8-10.99/11.54/0.00 PROJECT

STA. 4293+10.00
END LANE TAPER

STA. 404+57.41
BEGIN LANE TAPER

COVENTRY STREET

COVENTRY STREET

LOVERS LANE

BURKHARDT AVENUE

BURKHARDT AVENUE

ITEM 622 - CONCRETE BARRIER,
SINGLE SLOPE, TYPE D

ITEM 609 - CURB, TYPE 4-A OR 4-C

ITEM 606 - GUARDRAIL, TYPE MGS

ITEM 622 - CONCRETE BARRIER,
SINGLE SLOPE, TYPE B1 OR C1

I.R. 77 (SOUTHBOUND)

I.R. 77 (NORTHBOUND)

S.R. 8 (SOUTHBOUND)

CONST. S.R. 8

CONST. I.R. 77

SUM-77-1152

PT Sta. 407+09.97

405

406

407

4293

4294

10.0'

56.0'

45.0'

10.0'

10.0'

48.0'

10.0'

8.5'

10.0'

NOTES:

1. FOR DETAILS REGARDING THE SUM-76/77/8-10.99/11.54/0.00 PROJECT SEE ATTACHMENT C.

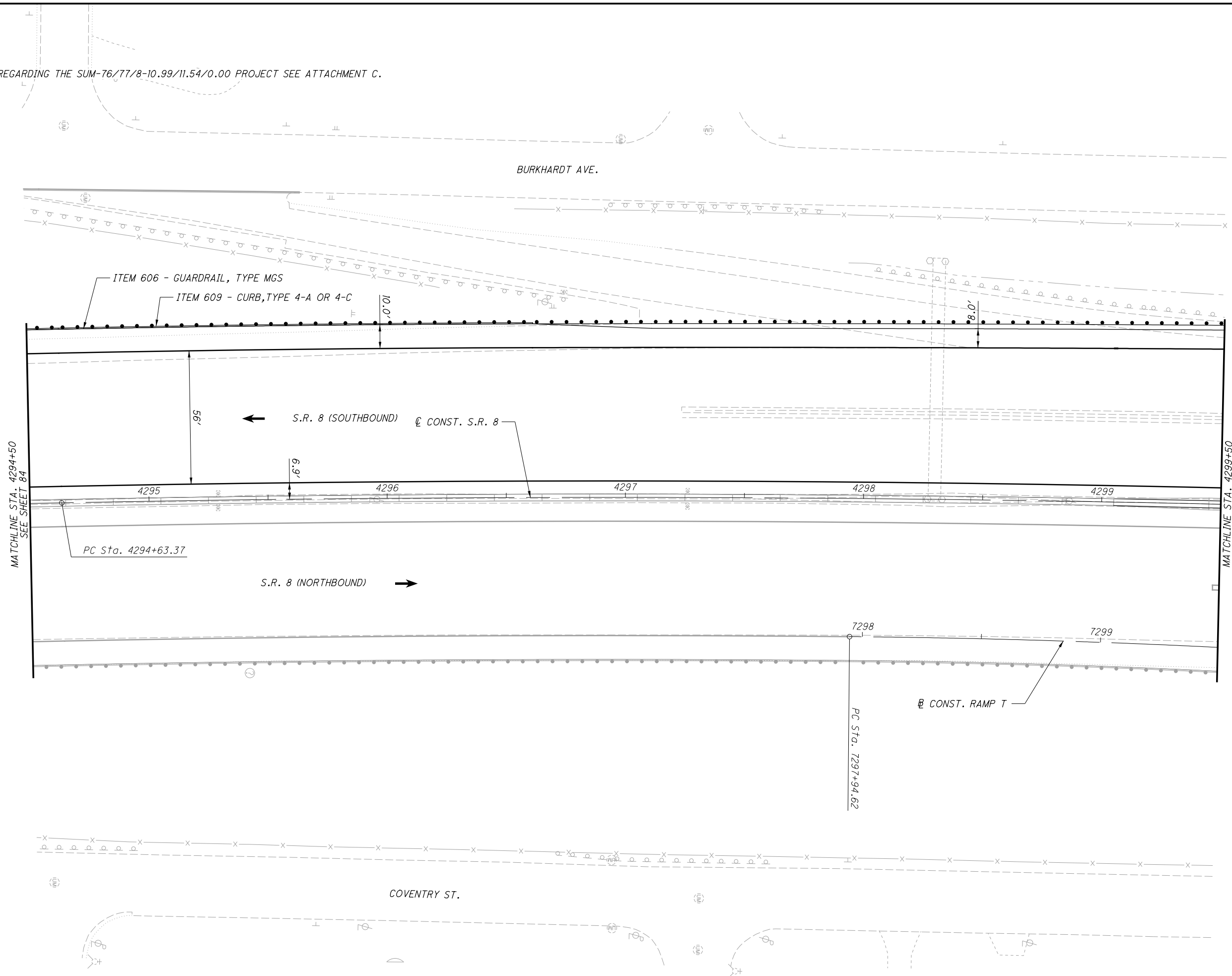

CALCULATED	MLL	CHECKED
		JTW

PLAN - S.R. 8
 STA. 4294+50 TO STA. 4299+50

SUM-76 / 77 / 8-
 8.24 / 9.74 / 0.00

P:\02329_SUM-76_77\Design\Roadway\Sheets\02329_GP220.dgn Sheet 1 8/7/2020 11:32:40 AM mlutes

NOTES:

1. FOR DETAILS REGARDING THE SUM-76/77/8-10.99/11.54/0.00 PROJECT SEE ATTACHMENT C.

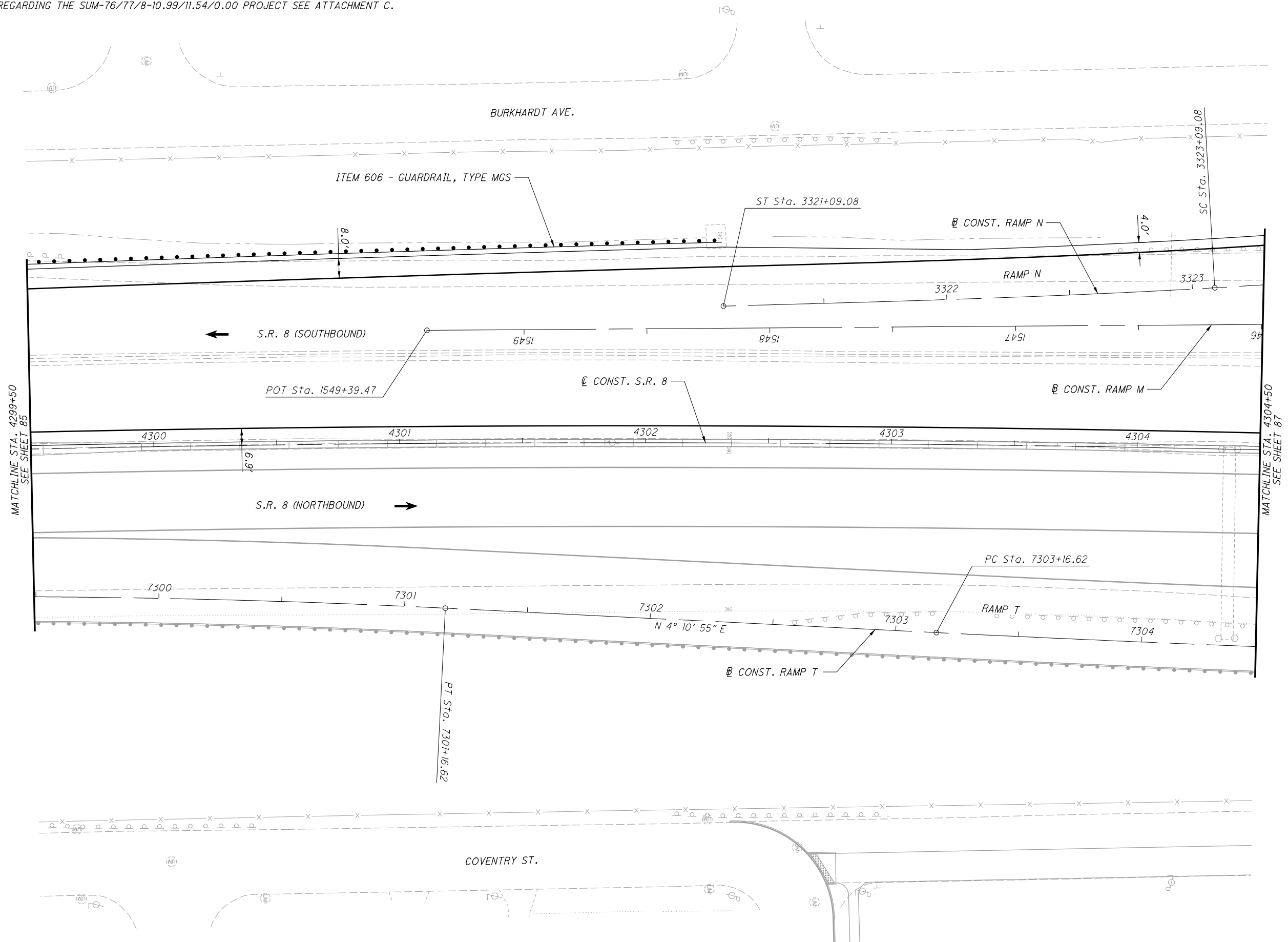

CALCULATED	MLL	CHECKED	JTW
------------	-----	---------	-----

PLAN - S.R. 8
STA. 4299+50 TO STA. 4304+50

SUM-76 / 77 / 8-
8.24 / 9.74 / 0.00

P:\02329_SUM-76_77\Design\Roadway\Sheets\02329_GP221.dgn Sheet 8/7/2020 11:32:41 AM mlr/tes

NOTES:

1. FOR DETAILS REGARDING THE SUM-76/77/8-10.99/11.54/0.00 PROJECT SEE ATTACHMENT C.

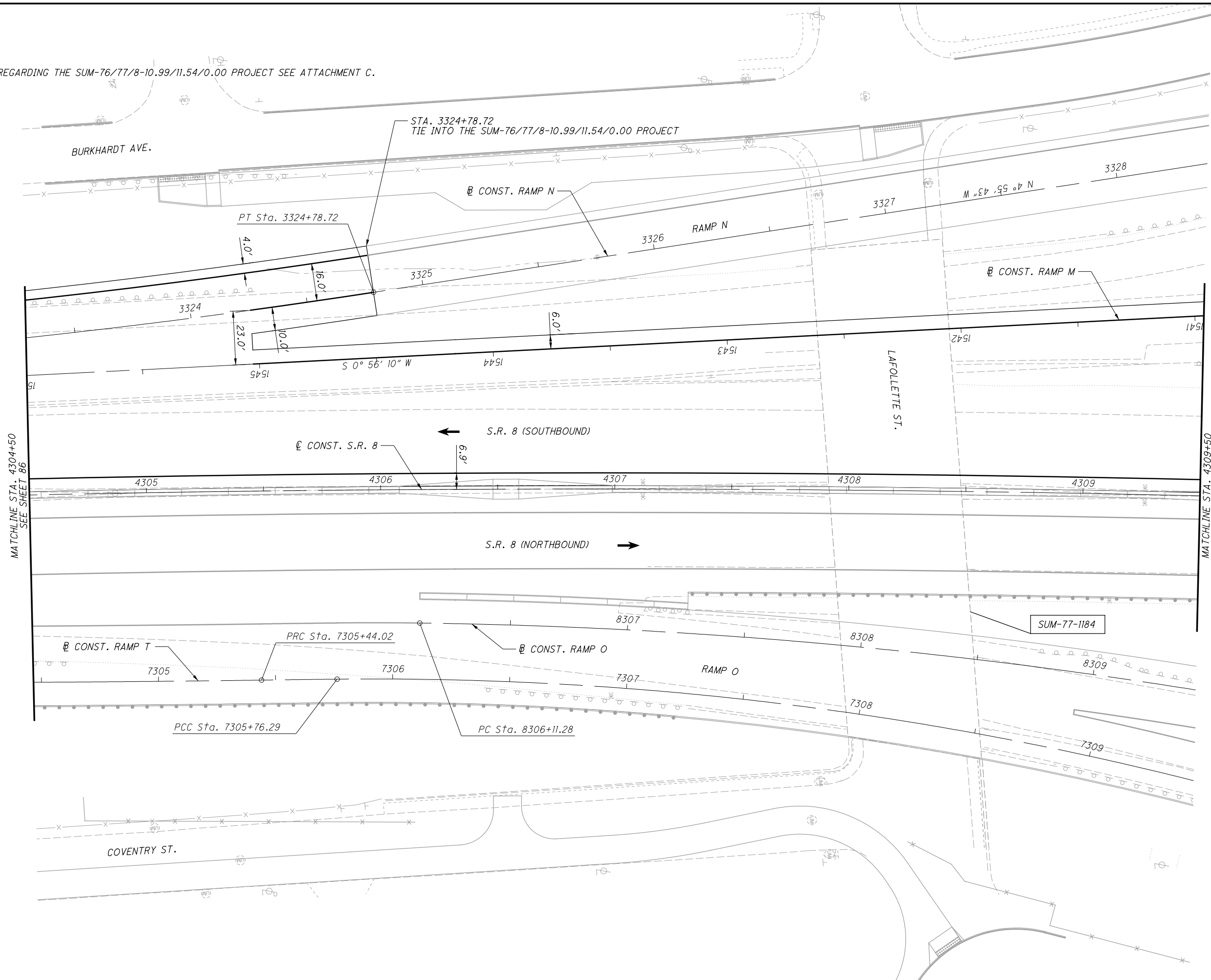

P:\02329_SUM-76_77\Design\Roadway\Sheets\02329_GP222.dgn Sheet 8/7/2020 11:32:44 AM milutes

SUM-76 / 77 / 8-
8.24 / 9.74 / 0.00

PLAN - S.R. 8
STA. 4304+50 TO STA. 4309+50

87
138

NOTES:

1. FOR DETAILS REGARDING THE SUM-76/77/8-10.99/11.54/0.00 PROJECT SEE ATTACHMENT C.

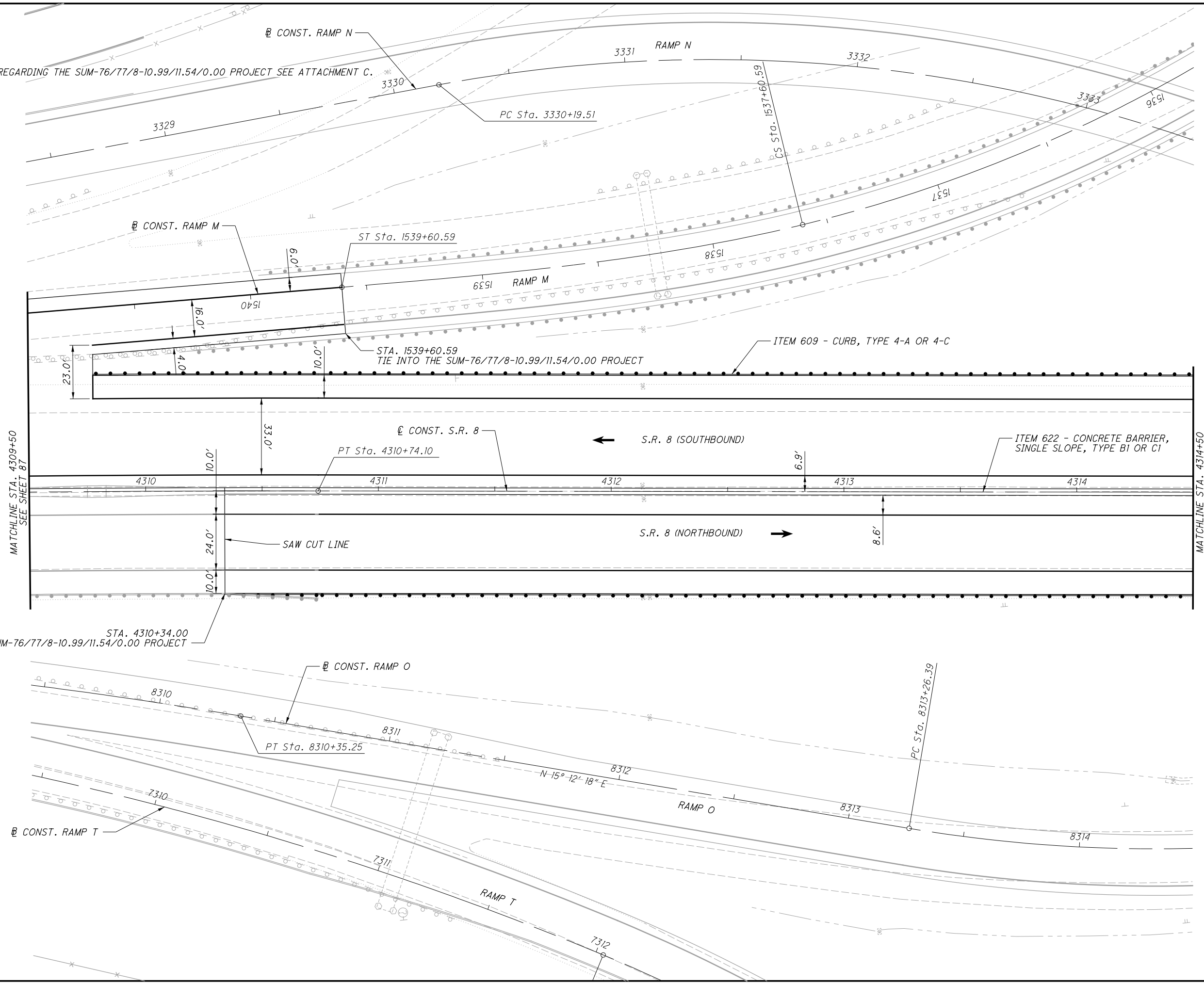

CALCULATED
M.L.L.
CHECKED
J.T.W.

0 20 40
HORIZONTAL
SCALE IN FEET

PLAN - S.R. 8
STA. 4309+50 TO STA. 4314+50

SUM-76/77/8-
8.24/9.74/0.00

P:\02329_SUM-76_77\Design\Roadway\Sheets\02329_GP223.dgn Sheet 8/7/2020 11:32:45 AM milutes

NOTES:

1. FOR DETAILS REGARDING THE SUM-76/77/8-10.99/11.54/0.00 PROJECT SEE ATTACHMENT C.

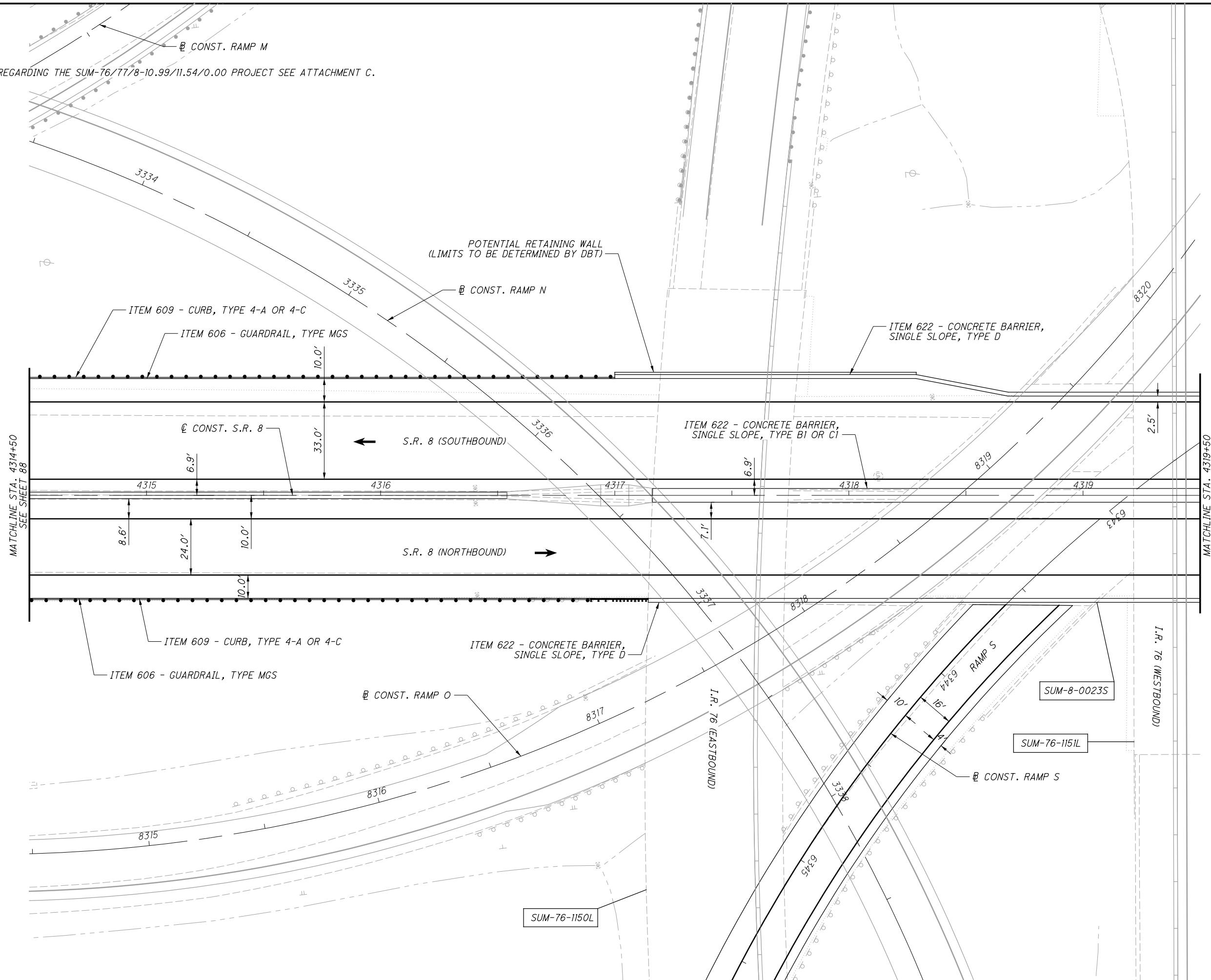

CALCULATED
M.L.L.
CHECKED
J.T.W.

0 20 40
HORIZONTAL
SCALE IN FEET

PLAN - S.R. 8
STA. 4314+50 TO STA. 4319+50

SUM-76/77/8-
8.24/9.74/0.00

89
138

P:\02329_SUM-76_77\Design\Roadway\Sheets\02329_GP224.dgn Sheet 8/7/2020 11:32:47 AM milutes



CALCULATED
MILL
CHECKED
JTW

PLAN - S.R. 8
STA. 4324+50 TO STA. 4329+50

SUM-76/77/8-
8.24/9.74/0.00

NOTES:

1. FOR DETAILS REGARDING THE SUM-76/77/8-10.99/11.54/0.00 PROJECT SEE ATTACHMENT C.

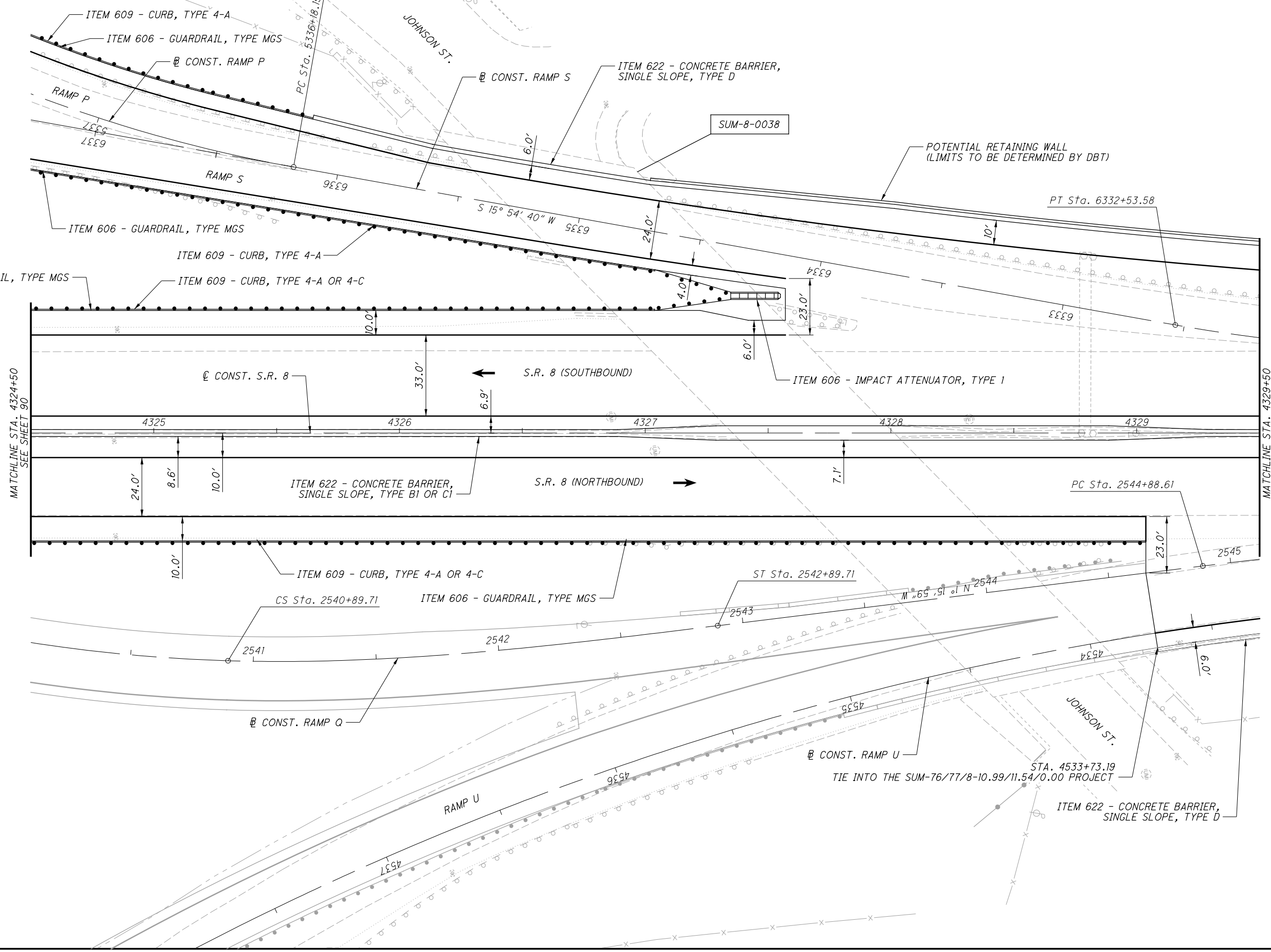

P:\102329_SUM-76_77\Design\Roadway\Sheets\102329_GP226.dgn Sheet 8/7/2020 11:32:50 AM miles

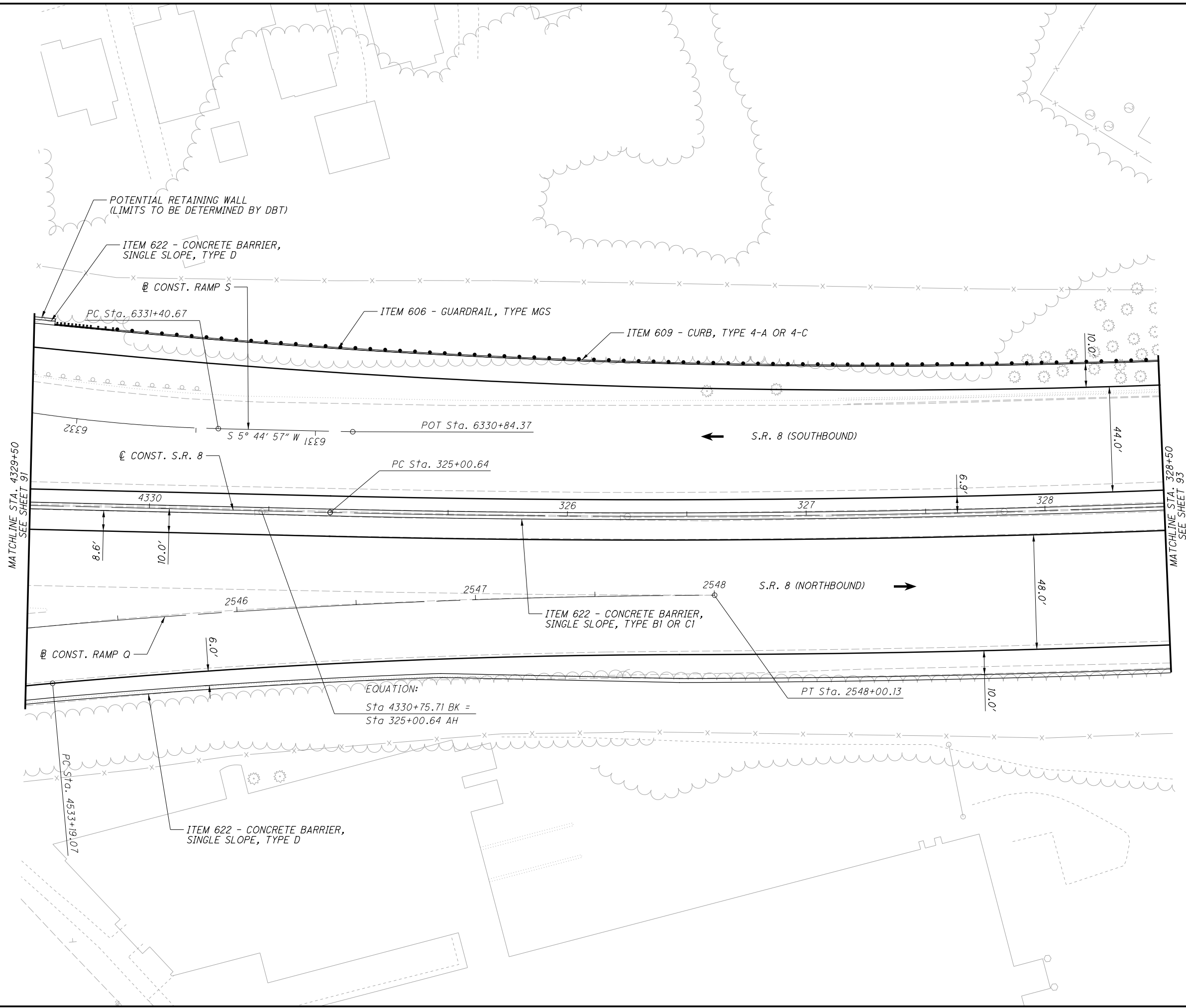

CALCULATED
MLL
CHECKED
JTW

0 20 40
HORIZONTAL
SCALE IN FEET

PLAN - S.R. 8
STA. 4329+50 TO STA. 328+50

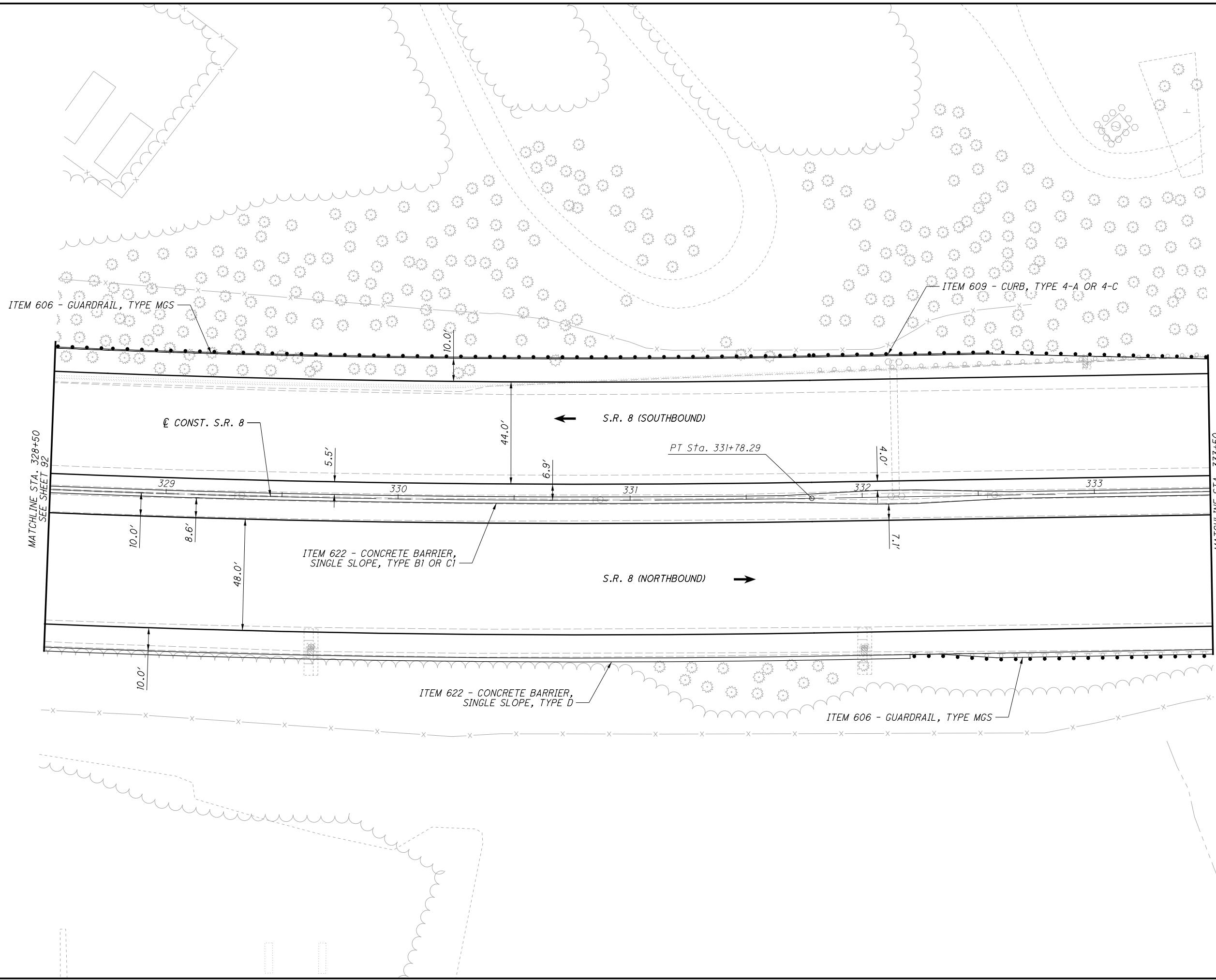

CALCULATED
MLL
CHECKED
JTW

0 20 40
HORIZONTAL
SCALE IN FEET

PLAN - S.R. 8
STA. 328+50 TO STA. 333+50

P:\102329_SUM-76_77\Design\Roadway\Sheets\102329_GP229.dgn Sheet 8/7/2020 11:33:01AM mlutes

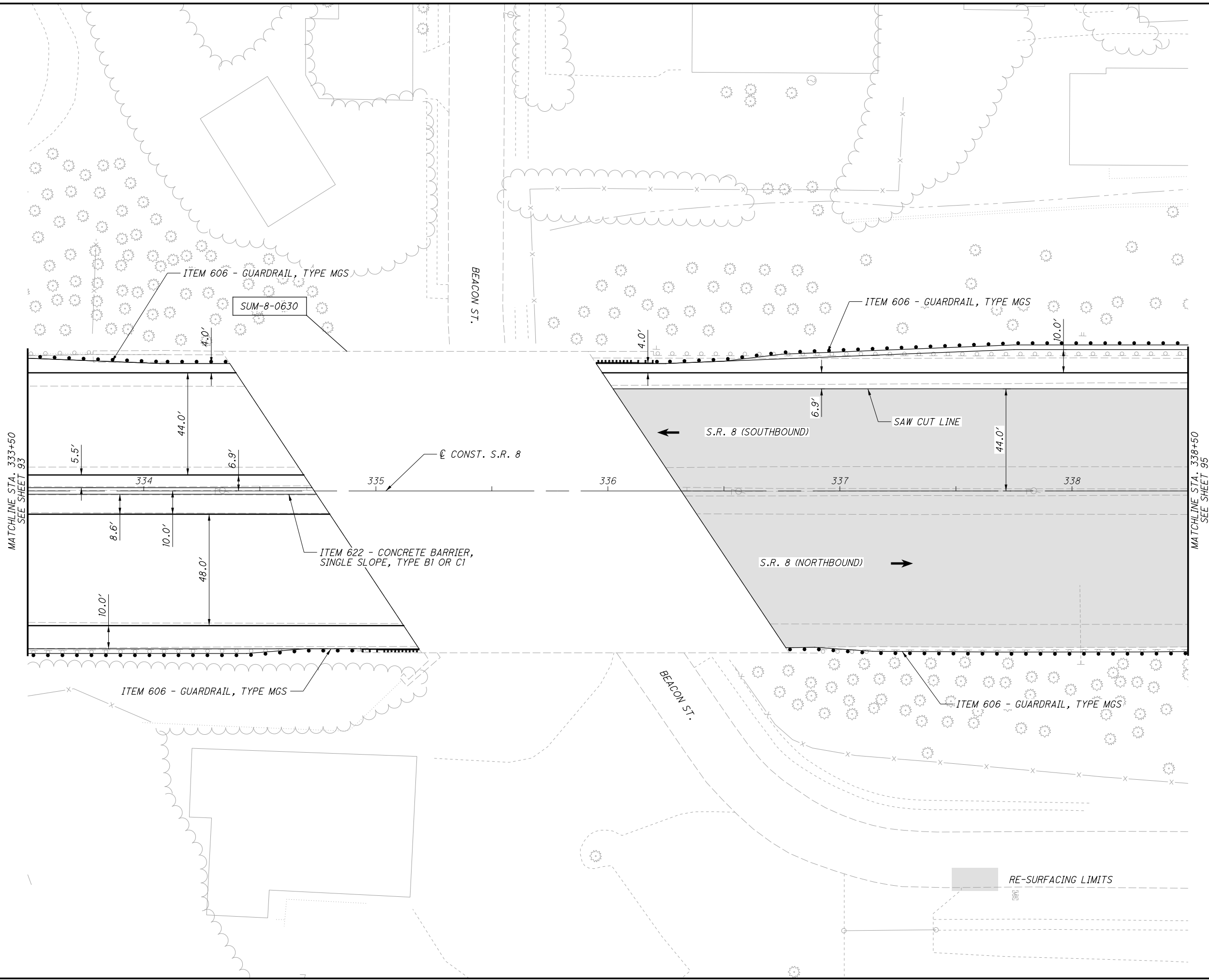

CALCULATED
MLL
CHECKED
JTW

0 20 40
HORIZONTAL
SCALE IN FEET

N

PLAN - S.R. 8
STA. 333+50 TO STA. 338+50

SUM-76 / 77 / 8-
8.24 / 9.74 / 0.00

P:\102329_SUM-76_77\Design\Roadway\Sheets\102329_GP230.dgn Sheet 8/7/2020 11:33:03 AM milutes

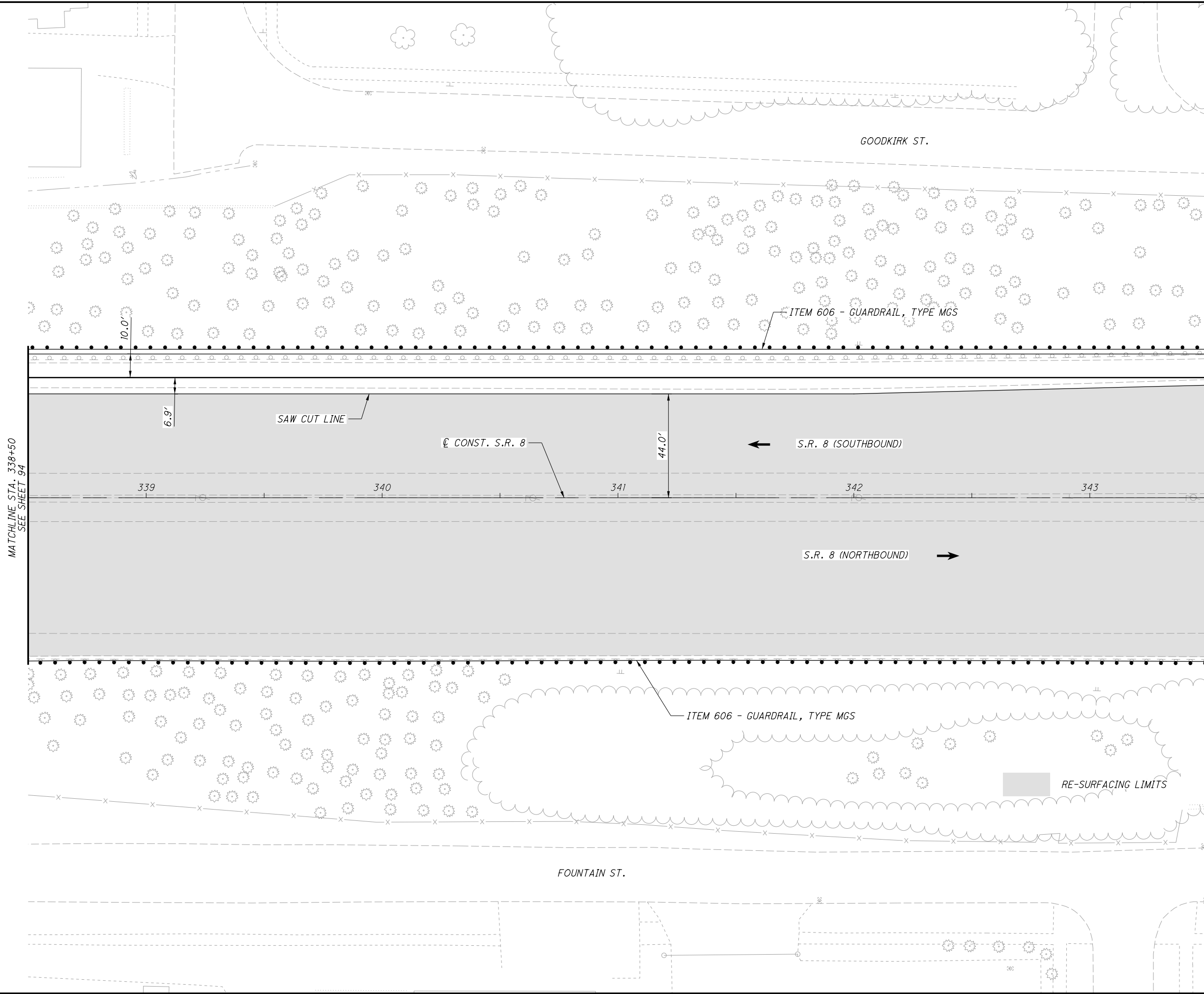

CALCULATED
M.L.L.
CHECKED
J.T.W.

0 20 40
HORIZONTAL
SCALE IN FEET

PLAN - S.R. 8
STA. 338+50 TO STA. 343+50

SUM-76 / 77 / 8-
8.24 / 9.74 / 0.00

P:\102329_SUM-76_77\Design\Roadway\Sheets\102329_GP231.dgn Sheet 8/7/2020 11:33:09 AM mlutes

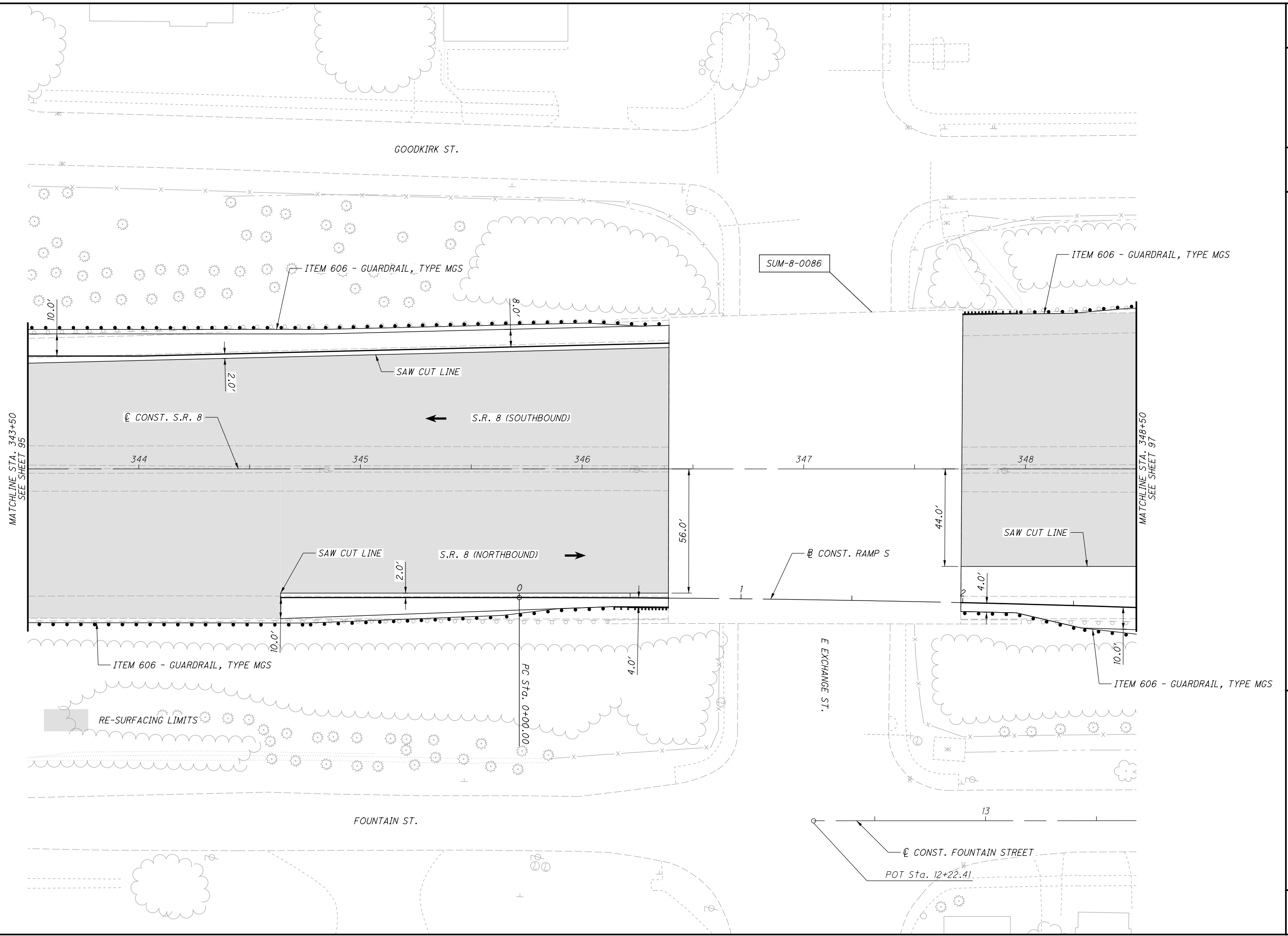

CALCULATED
M.L.L.
CHECKED
J.T.W.

0 20 40
HORIZONTAL
SCALE IN FEET

PLAN - S.R. 8
STA. 343+50 TO STA. 348+50

SUM-76 / 77 / 8-
8.24 / 9.74 / 0.00

96
138

P:\02329_SUM-76_77\Design\Roadway\Sheets\02329_GP232.dgn Sheet 8/7/2020 11:33:0 AM mlr/tes

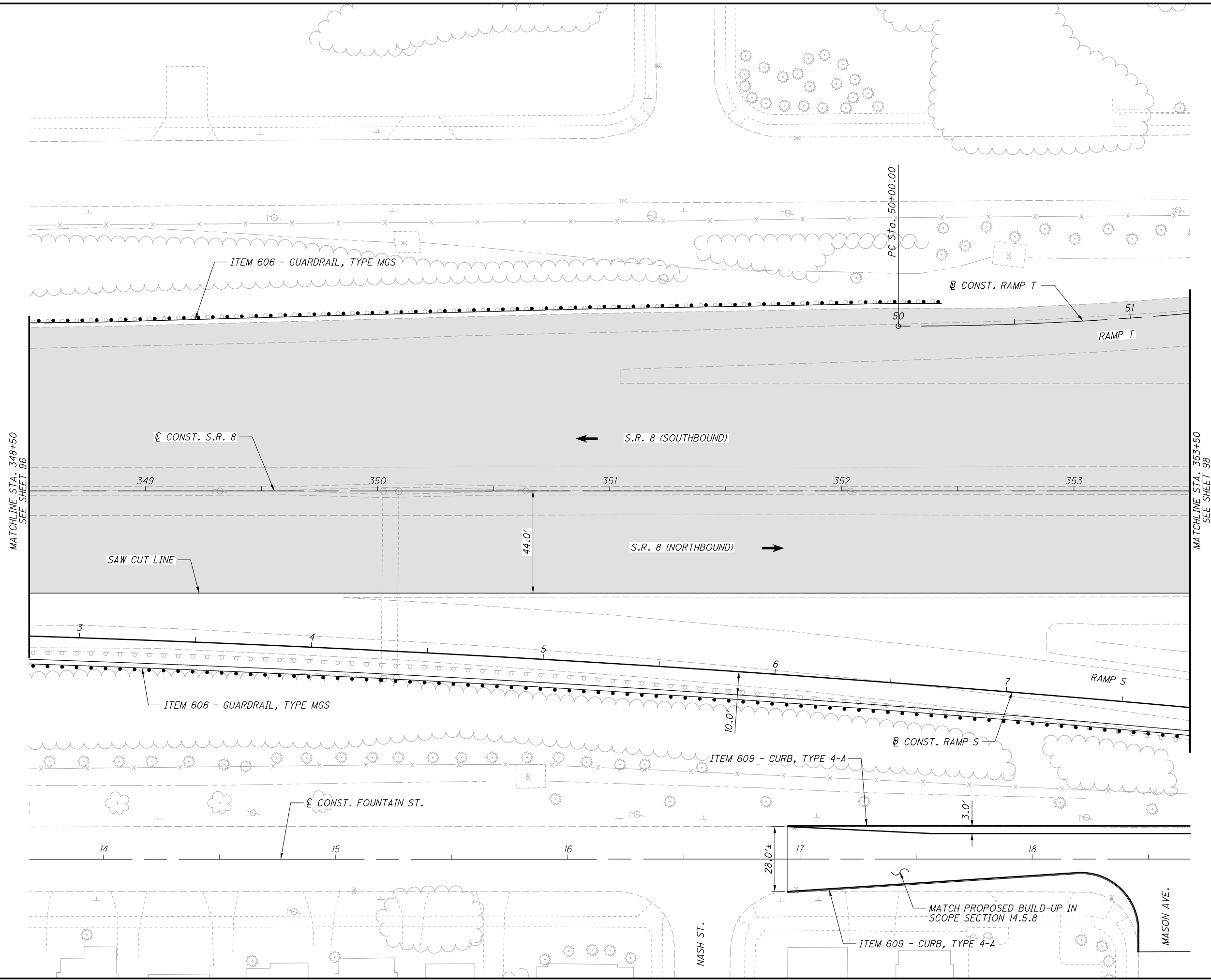

CALCULATED
MLL
CHECKED
JTW

0 20 40
HORIZONTAL
SCALE IN FEET

PLAN - S.R. 8
STA. 348+50 TO STA. 353+50

SUM-76 / 77 / 8-
8.24 / 9.74 / 0.00

*RESURFACING ENDS AT PHYSICAL GORE OF RAMP T AND GOODKIRK ST.

RE-SURFACING LIMITS



CALCULATED
M.L.L.
CHECKED
J.T.W.

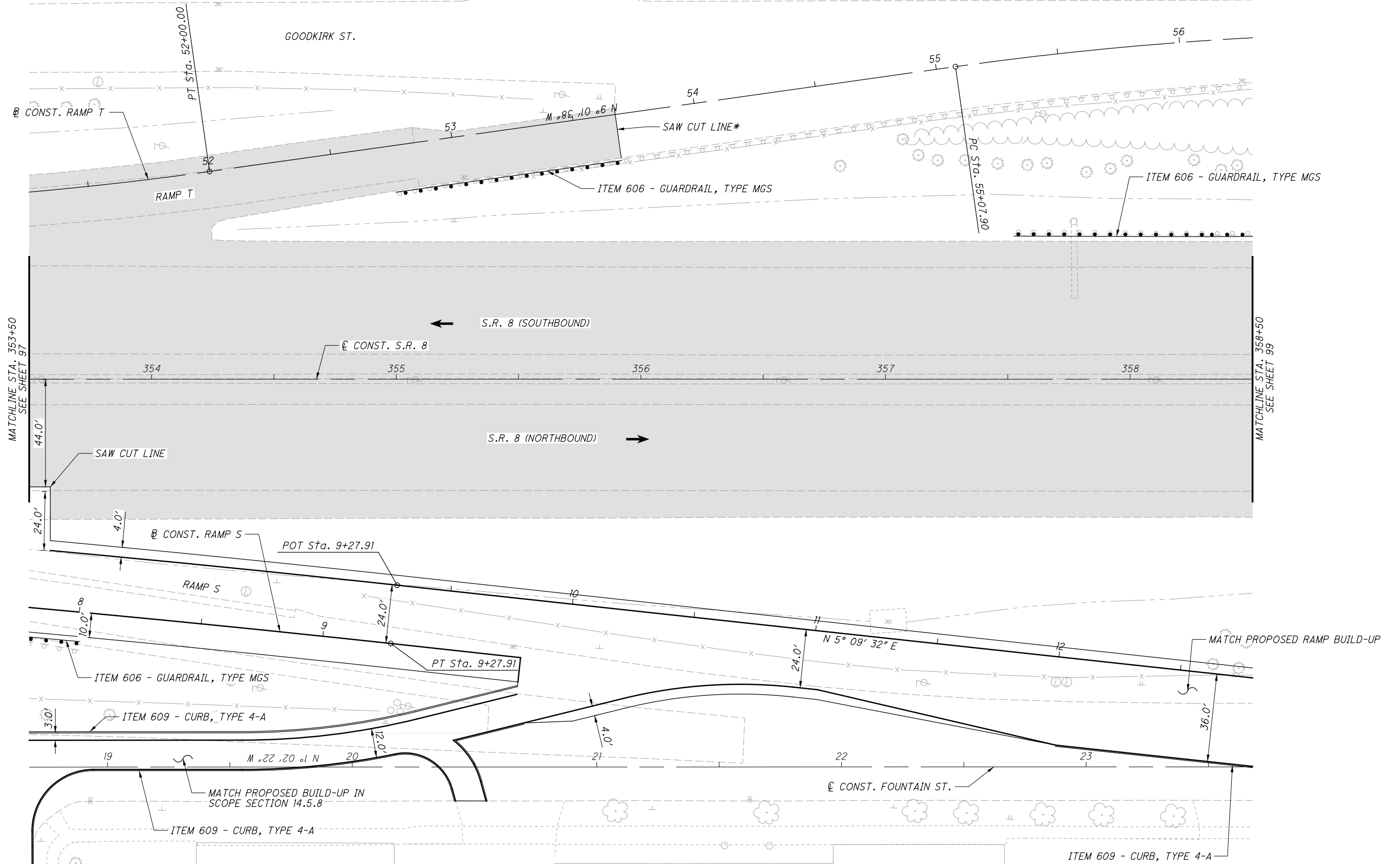

PLAN - S.R. 8
STA. 353+50 TO STA. 358+50

SUM-76 / 77 / 8-
8.24 / 9.74 / 0.00

98
138

P:\102329_SUM-76_77\Design\Roadway\Sheets\102329_GP233.dgn Sheet 8/7/2020 11:33:11 AM mlites

P:\02329_SUM-76_77\Design\Roadway\Sheets\02329_GP234.dgn Sheet 8/7/2020 11:33:13 AM mlutes

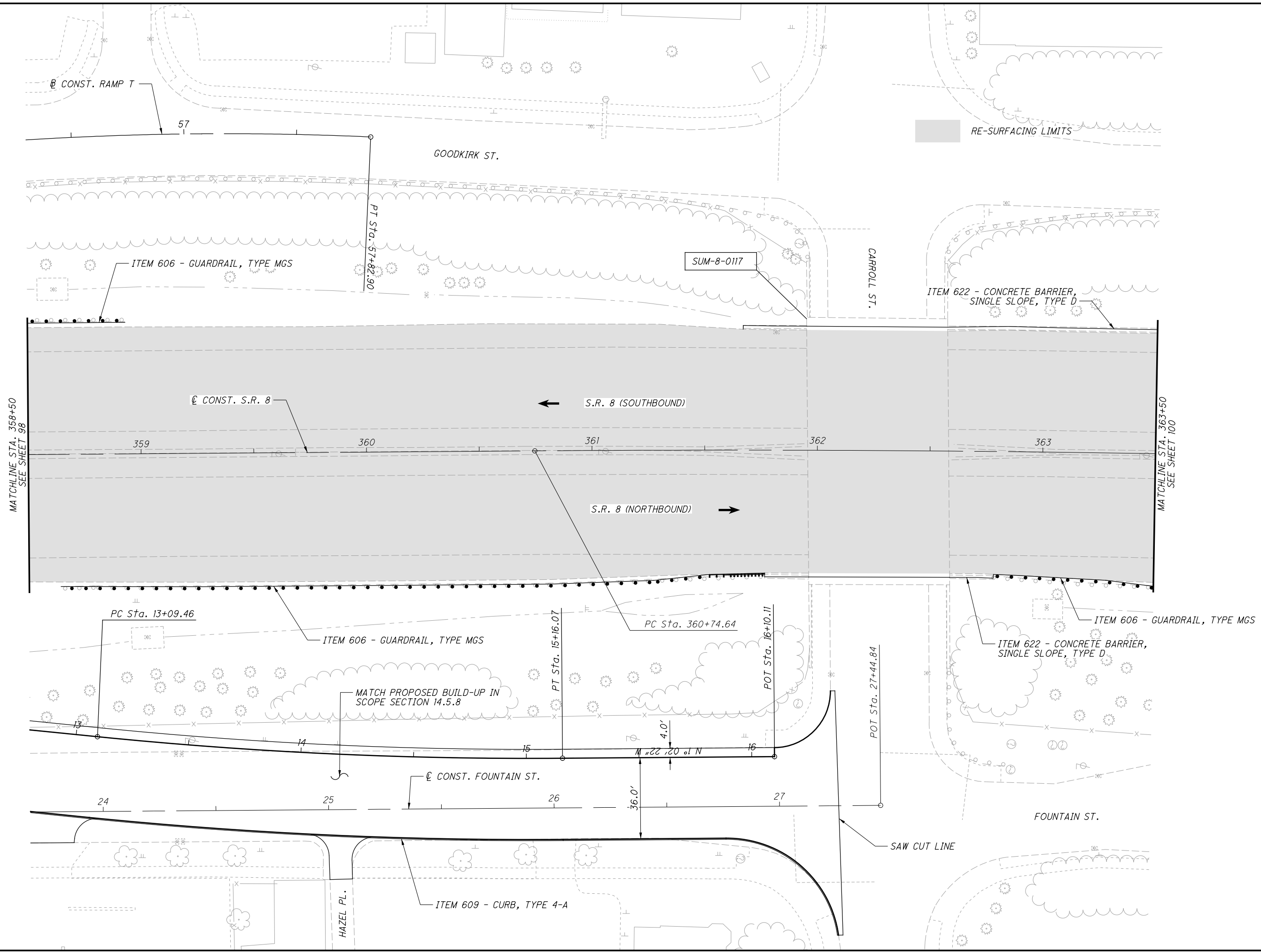

CALCULATED
M.L.L.
CHECKED
J.T.W.

0 20 40
HORIZONTAL
SCALE IN FEET

PLAN - S.R. 8
STA. 358+50 TO STA. 363+50

SUM-76 / 77 / 8-
8.24 / 9.74 / 0.00

P:\102329_SUM-76_77\Design\Roadway\Sheets\102329_GP235.dgn Sheet 8/7/2020 11:33:14 AM mlutes

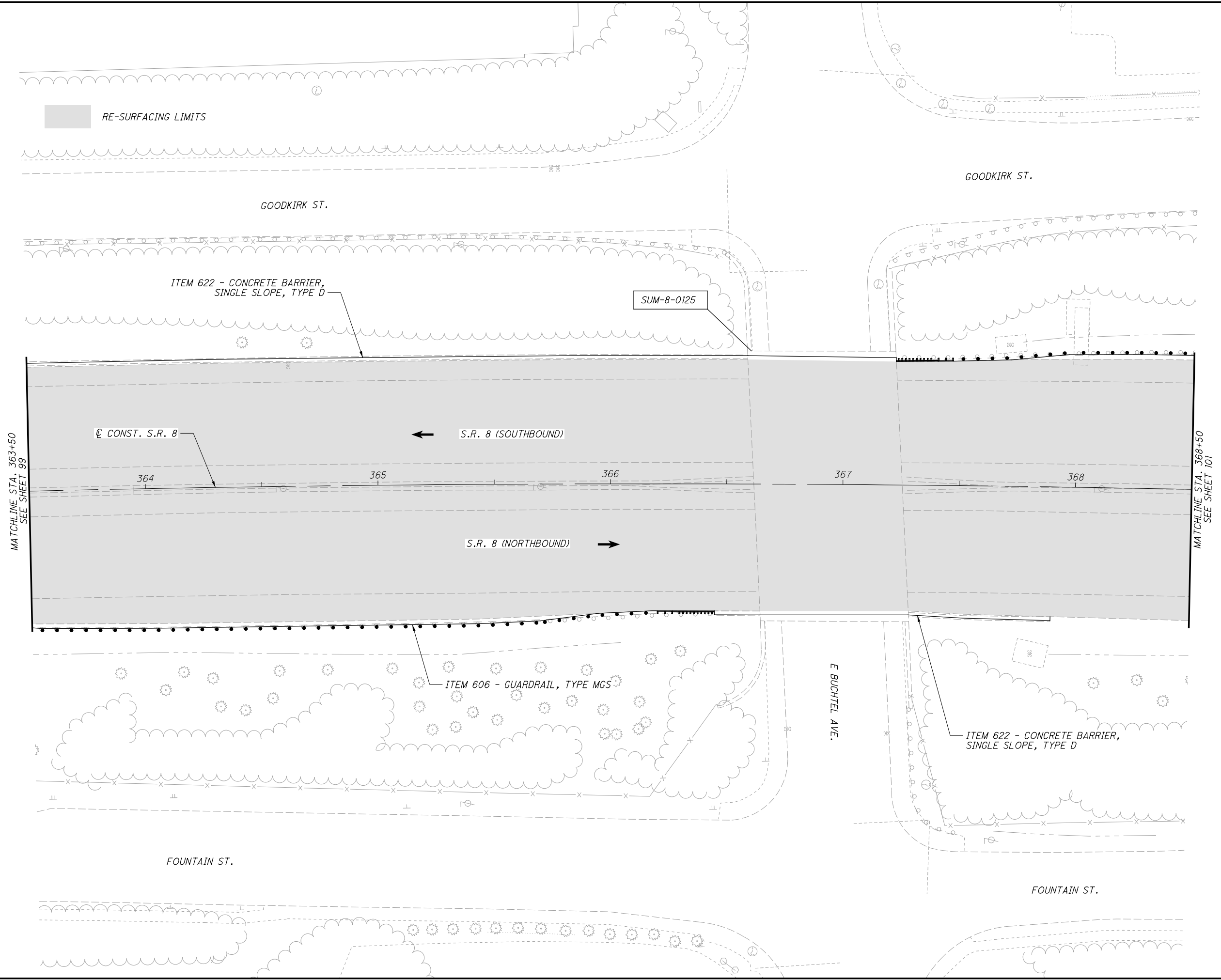

CALCULATED
M.L.L.
CHECKED
J.T.W.

0 20 40
HORIZONTAL
SCALE IN FEET

PLAN - S.R. 8
STA. 358+50 TO STA. 368+50

SUM-76 / 77 / 8-
8.24 / 9.74 / 0.00

100
138

P:\02329_SUM-76_77\Design\Roadway\Sheets\02329_GP236.dgn Sheet 8/7/2020 11:33:16 AM mlutes

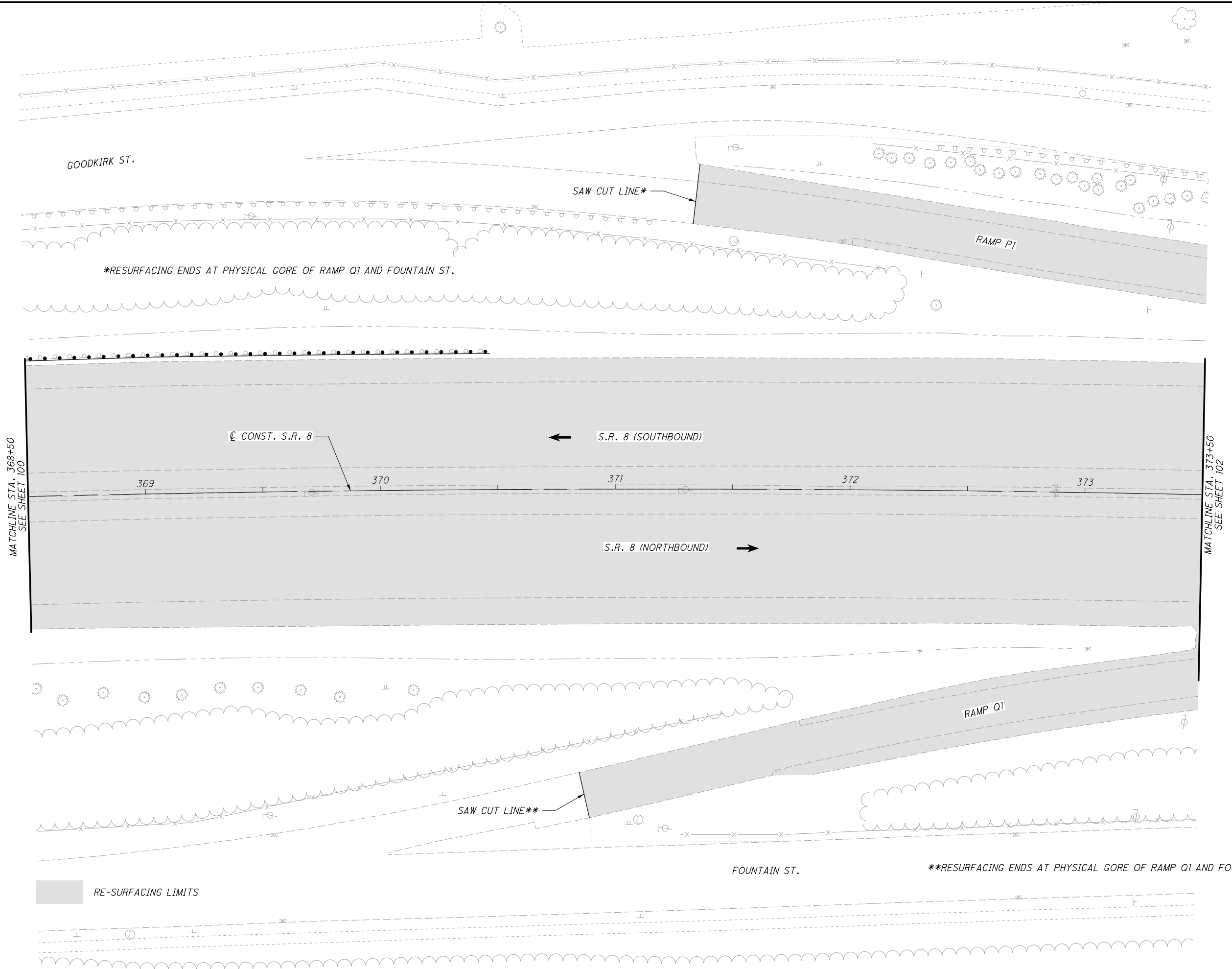

CALCULATED
M.L.L.
CHECKED
J.T.W.

PLAN - S.R. 8
STA. 368+50 TO STA. 373+50

SUM-76 / 77 / 8-
8.24 / 9.74 / 0.00

101
138

P:\02329_SUM-76_77\Design\Roadway\Sheets\02329_GP237.dgn Sheet 8/7/2020 11:33:17 AM mlutes

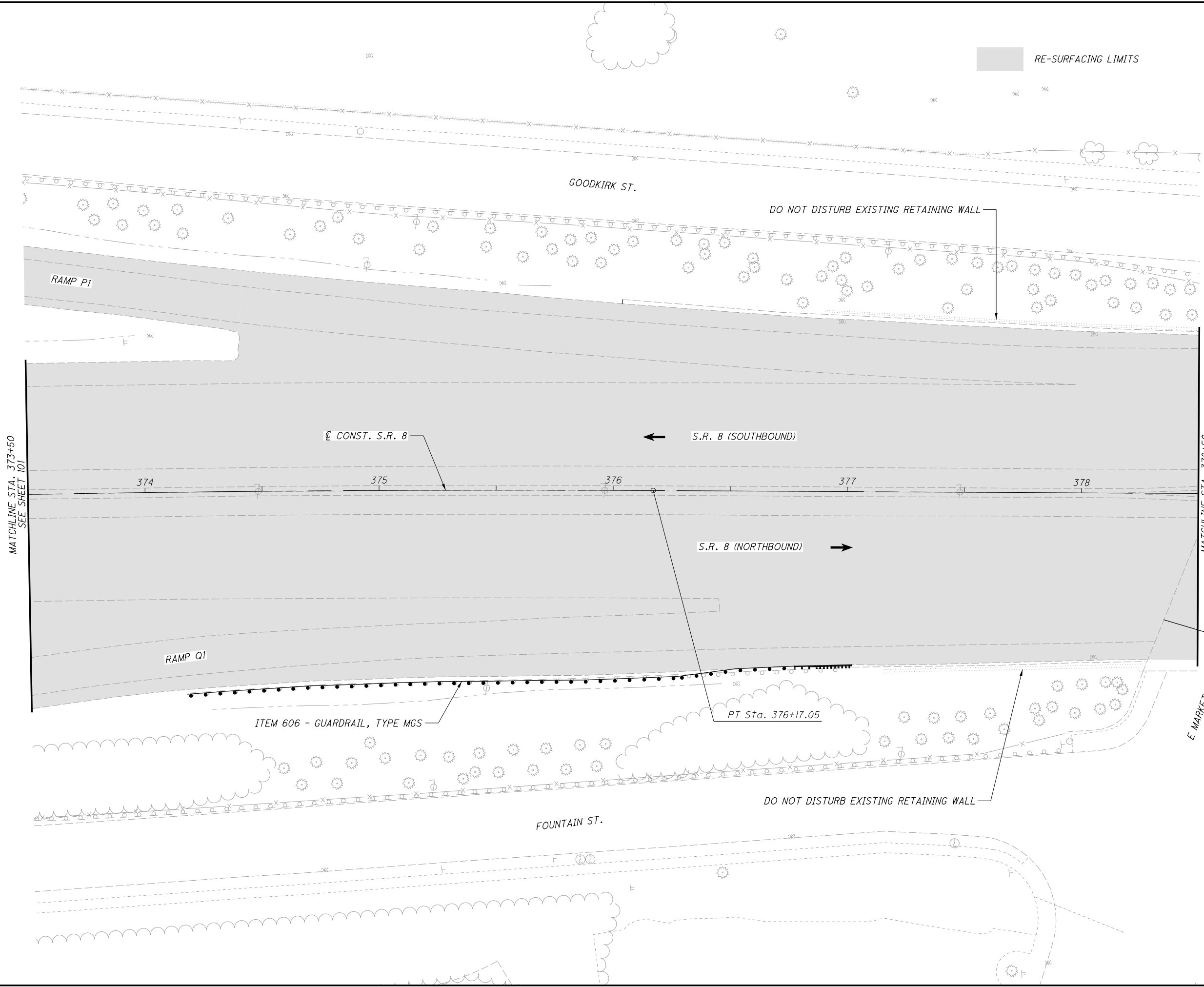

CALCULATED
MLL
CHECKED
JTW

0 20 40
HORIZONTAL
SCALE IN FEET

PLAN - S.R. 8
STA. 373+50 TO STA. 378+50

SUM-76 / 77 / 8-
8.24 / 9.74 / 0.00

P:\102329_SUM-76_77\Design\Roadway\Sheets\102329_GP238.dgn Sheet 8/7/2020 11:33:18 AM mlutes

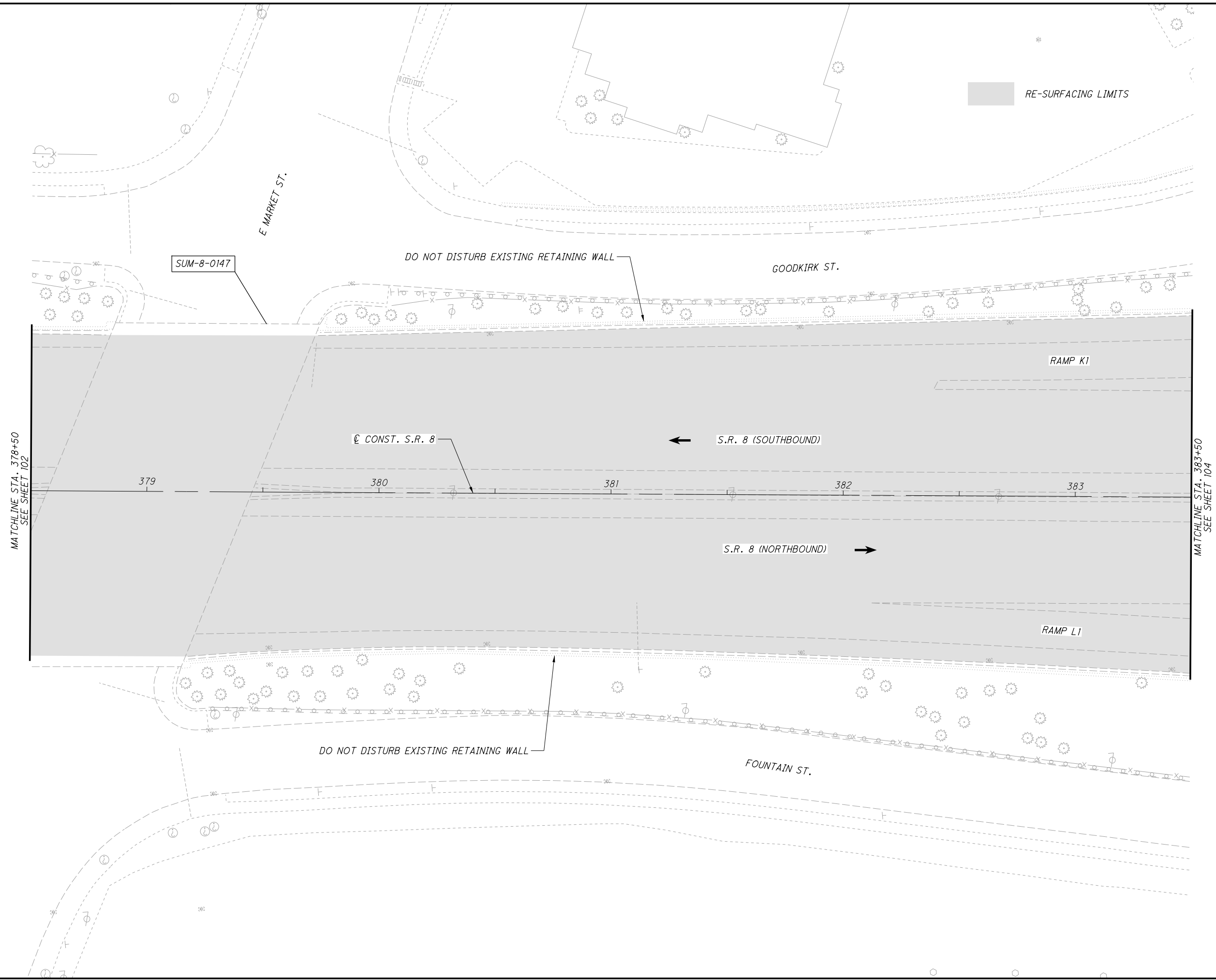

CALCULATED
M.L.L.
CHECKED
J.T.W.

0 20 40
HORIZONTAL
SCALE IN FEET

PLAN - S.R. 8
STA. 378+50 TO STA. 383+50

SUM-76/77/8-
8.24/9.74/0.00

103
138

P:\102329_SUM-76_77\Design\Roadway\Sheets\102329_GP239.dgn Sheet 8/7/2020 11:33:32 AM milutes

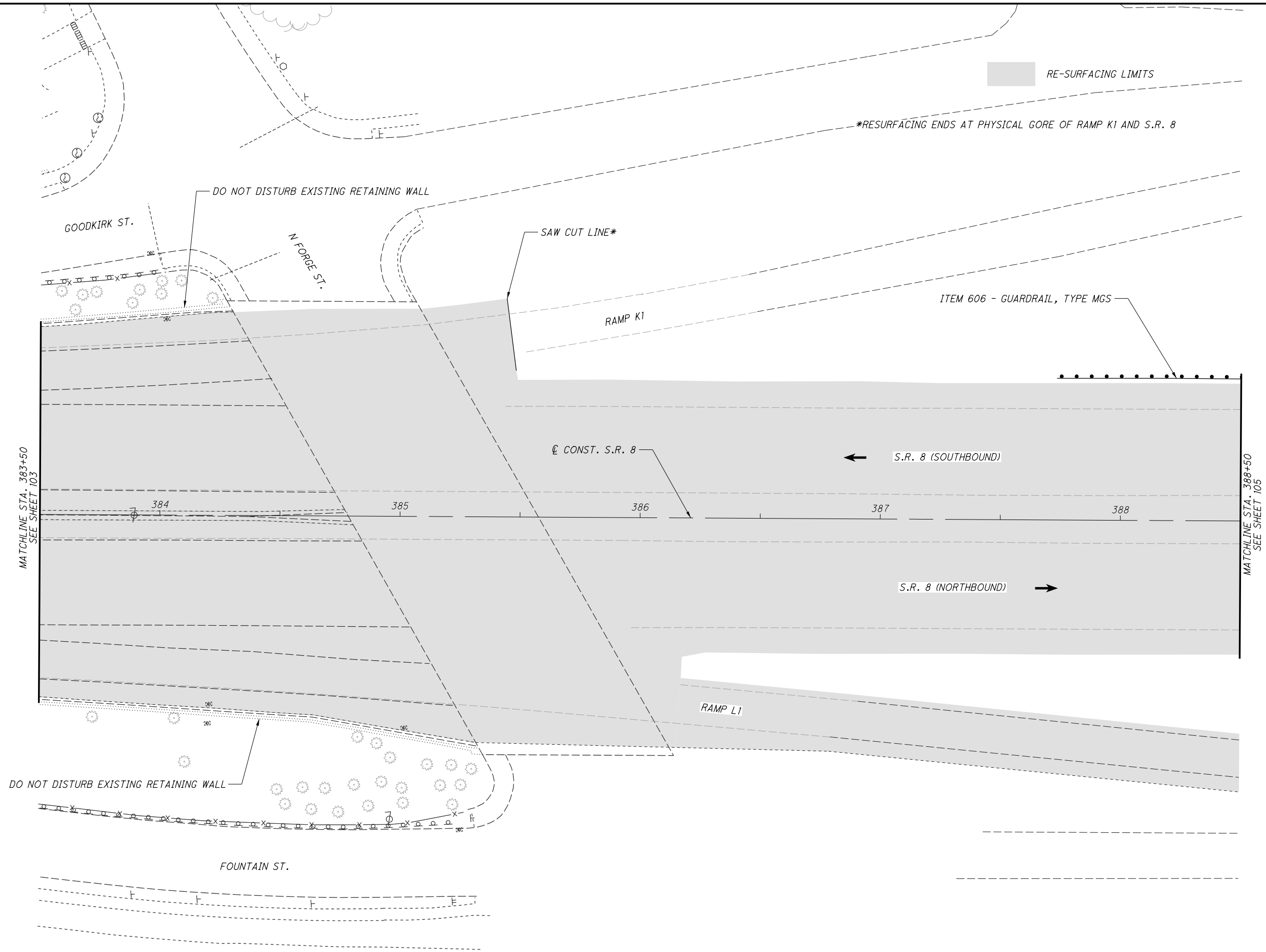

CALCULATED
M.L.L.
CHECKED
J.T.W.

0 20 40
HORIZONTAL
SCALE IN FEET

PLAN - S.R. 8
STA. 383+50 TO STA. 388+50

SUM-76/77/8-
8.24/9.74/0.00

P:\02329_SUM-76_77\Design\Roadway\Sheets\02329_GP240.dgn Sheet 8/7/2020 11:33:36 AM miles

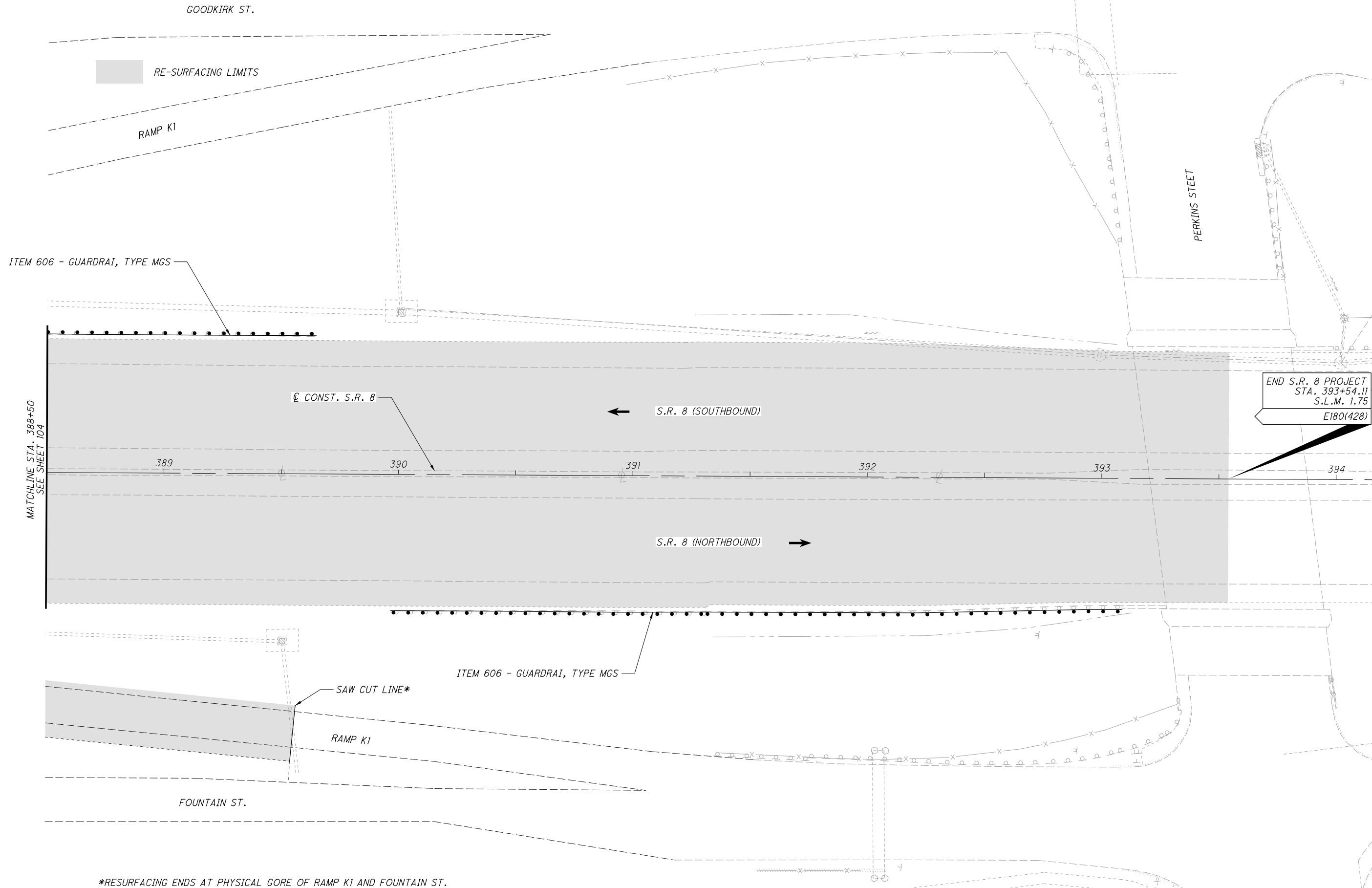

*RESURFACING ENDS AT PHYSICAL GORE OF RAMP K1 AND FOUNTAIN ST.

CALCULATED
M.L.L.
CHECKED
J.T.W.

0 10 20 40
HORIZONTAL
SCALE IN FEET

PLAN - S.R. 8
STA. 388+50 TO END S.R. 8 PROJECT

SUM-76/77/8-
8.24/9.74/0.00

P:\02329_SUM-76_77\Design\Roadway\Sheets\02329_GP241.dgn Sheet 1 8/7/2020 11:33:39 AM mlutes

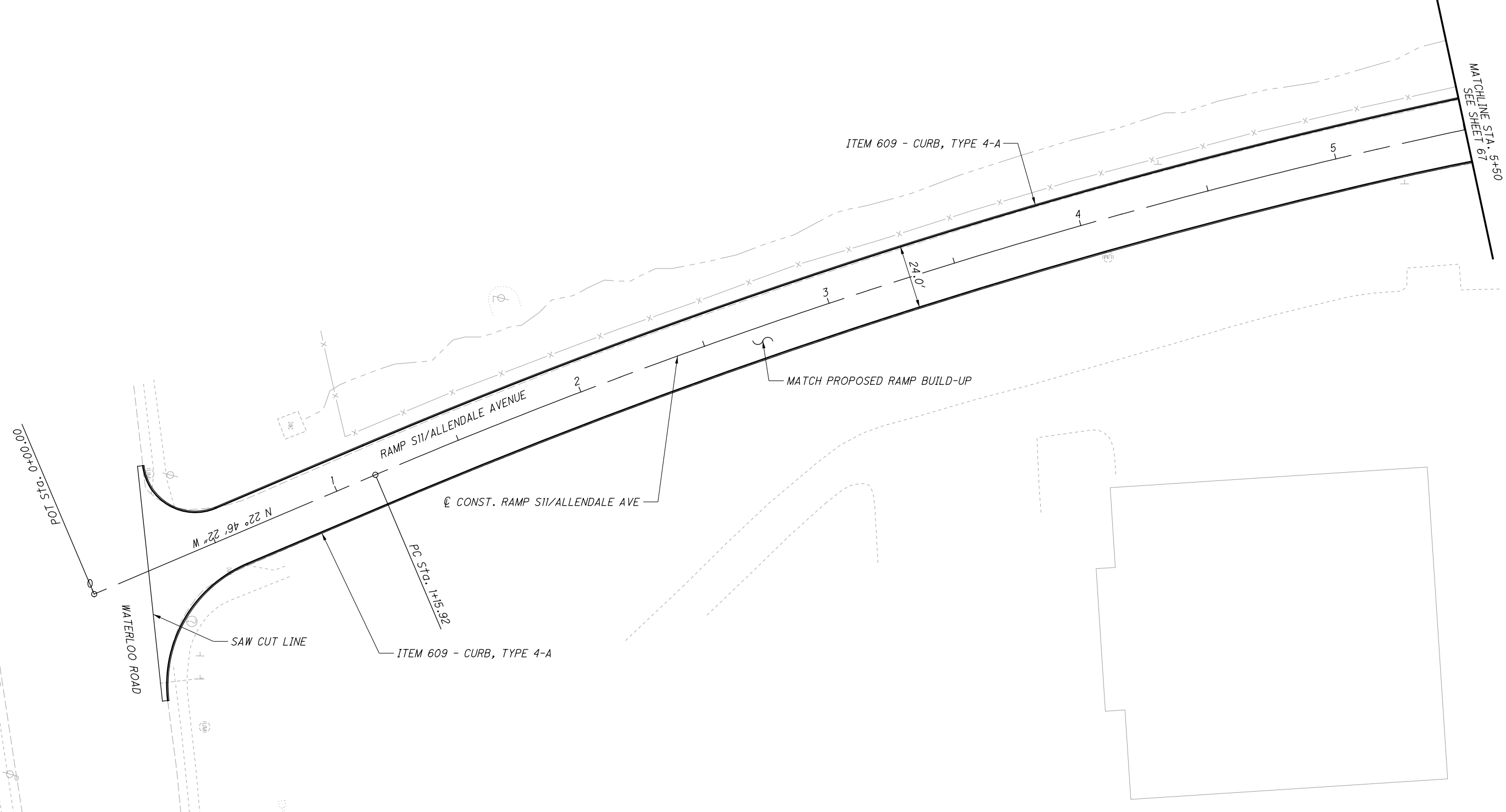

106
138

SUM-76 / 77 / 8-
8.24 / 9.74 / 0.00

PLAN - RAMP S11
BEGIN WORK TO STA. 5+50

CALCULATED
MLL
CHECKED
JTW

0 20 40
HORIZONTAL
SCALE IN FEET



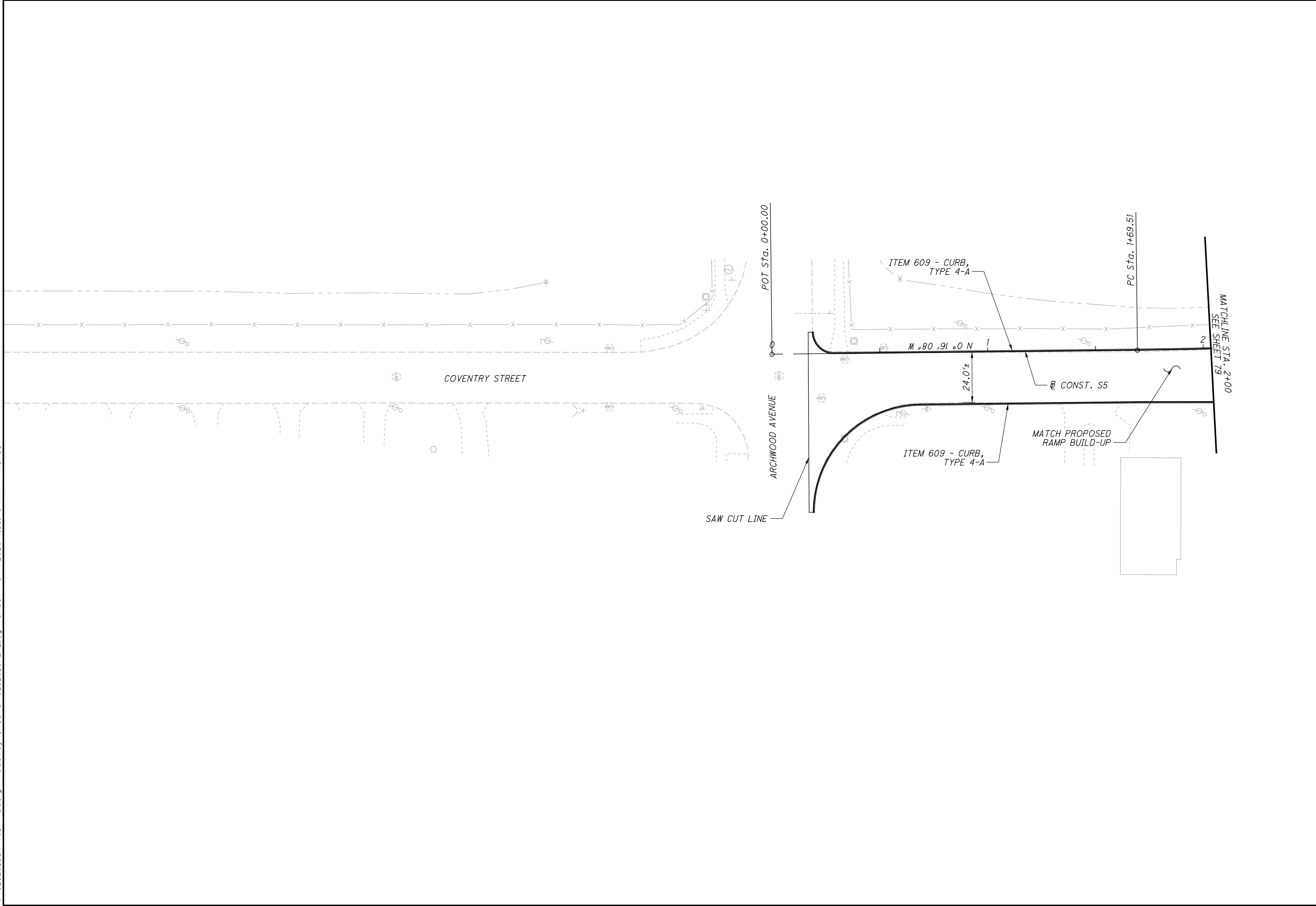

CALCULATED	MLL
CHECKED	JTW

0 20 40
HORIZONTAL SCALE IN FEET

N

PLAN - RAMP S5
BEGIN WORK TO STA. 2+00

SUM-76 / 77 / 8-
8.24 / 9.74 / 0.00

NOTES:

1. PAVEMENT MARKINGS ARE WHOLLY THE RESPONSIBILITY OF THE DESIGN BUILD TEAM AND ARE SHOWN HERE FOR REFERENCE ONLY.
2. FOR GEOMETRIC INFORMATION, SEE SHEETS 3 TO 7.
3. PLACE BARRIER REFLECTORS ALONG THE MEDIAN BARRIER ALONG I.R. 76/I.R. 77 IN THE EB/WB & SB/NB DIRECTION FROM THE VERNON ODOM BLVD. INTERCHANGE TO THE PRINCETON ST. OVERPASS.
4. PLACE RPMS ALONG EDGE LINES AND LANE LINES ALONG I.R. 76/I.R. 77 IN THE EB/WB & SB/NB DIRECTION FROM THE VERNON ODOM BLVD. INTERCHANGE TO THE PRINCETON ST. OVERPASS, INCLUDING ALL RAMPS.

LEGEND:

- | | |
|-------------------------------------|---------------------------------|
| (ELW) PROPOSED EDGE LINE, WHITE | (XW) PROPOSED CROSSWALK LINE |
| (ELY) PROPOSED EDGE LINE, YELLOW | (A) PROPOSED LANE ARROW |
| (LL) PROPOSED LANE LINE | (W) PROPOSED WORD ON PAVEMENT |
| (CH) PROPOSED CHANNELIZING LINE | (DL) PROPOSED DOTTED LINE |
| (SL) PROPOSED STOP LINE | (TR) PROPOSED TRAVERSE MARKINGS |
| (ELY) PROPOSED EDGE LINE, 8" YELLOW | |
| (ELW) PROPOSED EDGE LINE, 8" WHITE | |
| (LL) PROPOSED LANE LINE, 8" WHITE | |

CALCULATED
KRM

CHECKED
MLL

0 50 100
HORIZONTAL
SCALE IN FEET

P:\102329_SUM-76_77\Design\Traffic\Sheets\102329_TP001.dgn 10/24/2020 11:47:14 AM mlutes

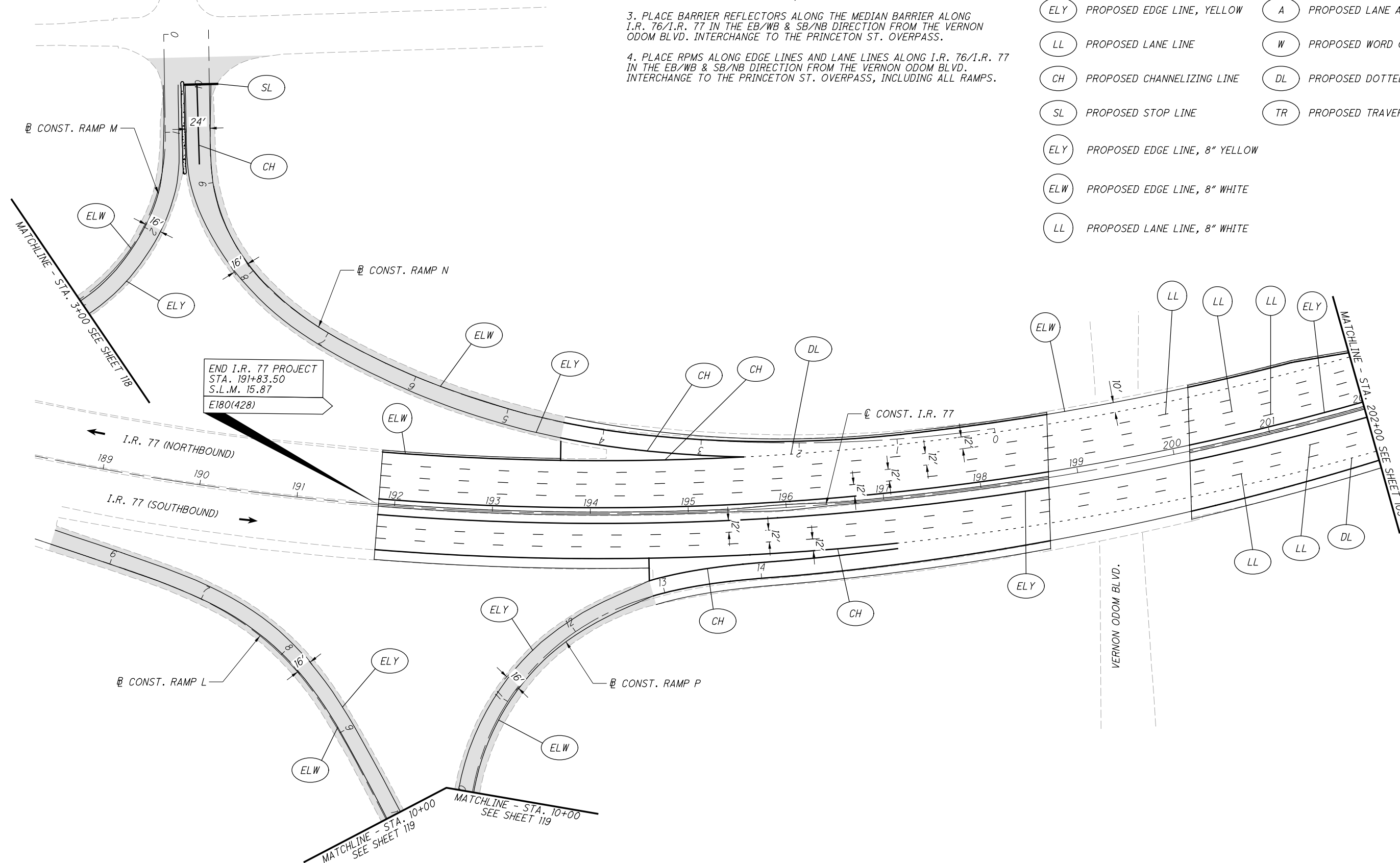

TRAFFIC CONTROL PLAN - I.R. 77
END I.R. 77 PROJECT TO STA. 202+00

SUM-76 / 77 / 8-
8.24 / 9.74 / 0.00

108
138

LEGEND:

- | | |
|-------------------------------------|---------------------------------|
| (ELW) PROPOSED EDGE LINE, WHITE | (XW) PROPOSED CROSSWALK LINE |
| (ELY) PROPOSED EDGE LINE, YELLOW | (A) PROPOSED LANE ARROW |
| (LL) PROPOSED LANE LINE | (W) PROPOSED WORD ON PAVEMENT |
| (CH) PROPOSED CHANNELIZING LINE | (DL) PROPOSED DOTTED LINE |
| (SL) PROPOSED STOP LINE | (TR) PROPOSED TRAVERSE MARKINGS |
| (ELY) PROPOSED EDGE LINE, 8" YELLOW | |
| (ELW) PROPOSED EDGE LINE, 8" WHITE | |
| (LL) PROPOSED LANE LINE, 8" WHITE | |

NOTES:

1. PAVEMENT MARKINGS ARE WHOLLY THE RESPONSIBILITY OF THE DESIGN BUILD TEAM AND ARE SHOWN HERE FOR REFERENCE ONLY.
2. FOR GEOMETRIC INFORMATION, SEE SHEETS 3 TO 7.
3. PLACE BARRIER REFLECTORS ALONG THE MEDIAN BARRIER ALONG I.R. 76/I.R. 77 IN THE EB/WB & SB/NB DIRECTION FROM THE VERNON ODOM BLVD. INTERCHANGE TO THE PRINCETON ST. OVERPASS.
4. PLACE RPMS ALONG EDGE LINES AND LANE LINES ALONG I.R. 76/I.R. 77 IN THE EB/WB & SB/NB DIRECTION FROM THE VERNON ODOM BLVD. INTERCHANGE TO THE PRINCETON ST. OVERPASS, INCLUDING ALL RAMP.

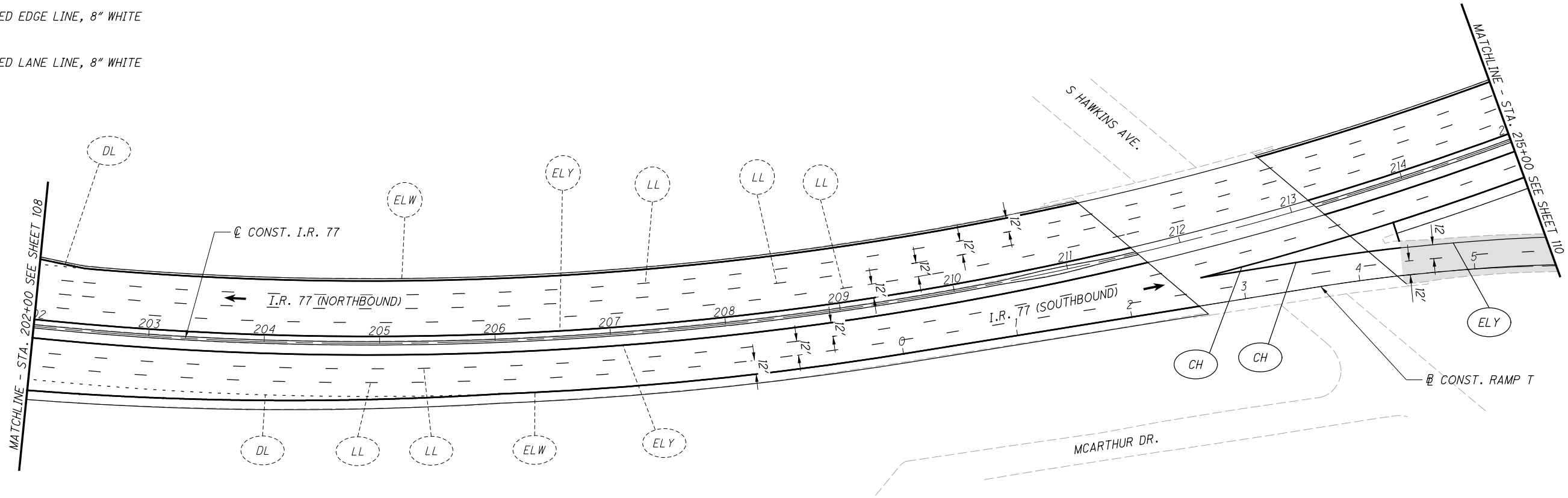

CALCULATED
KRM
CHECKED
MLL

0 50 100
25
HORIZONTAL
SCALE IN FEET

TRAFFIC CONTROL PLAN - I.R. 77
STA. 202+00 TO STA. 215+00

SUM-76/77/8-
8.24/9.74/0.00

LEGEND:

- (ELW) PROPOSED EDGE LINE, WHITE
- (ELY) PROPOSED EDGE LINE, YELLOW
- (LL) PROPOSED LANE LINE
- (CH) PROPOSED CHANNELIZING LINE
- (SL) PROPOSED STOP LINE
- (ELY) PROPOSED EDGE LINE, 8" YELLOW
- (ELW) PROPOSED EDGE LINE, 8" WHITE
- (LL) PROPOSED LANE LINE, 8" WHITE
- (XW) PROPOSED CROSSWALK LINE
- (A) PROPOSED LANE ARROW
- (W) PROPOSED WORD ON PAVEMENT
- (DL) PROPOSED DOTTED LINE
- (TR) PROPOSED TRAVERSE MARKINGS



CALCULATED	KRM
CHECKED	MLL

TRAFFIC CONTROL PLAN - I.R. 77
STA. 215+00 TO STA. 228+00

SUM-76/77/8-
8.24/9.74/0.00

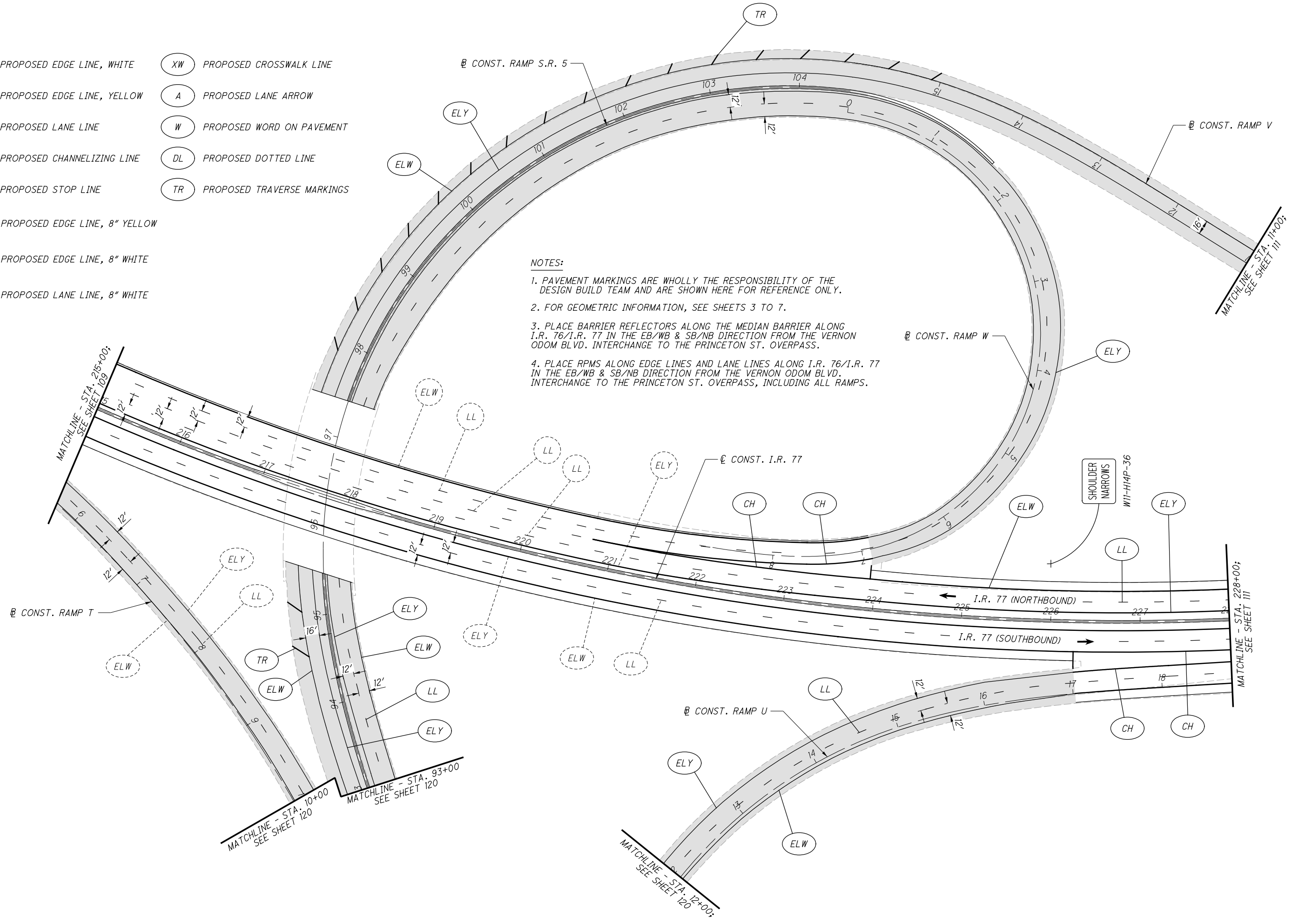

- NOTES:
1. PAVEMENT MARKINGS ARE WHOLLY THE RESPONSIBILITY OF THE DESIGN BUILD TEAM AND ARE SHOWN HERE FOR REFERENCE ONLY.
 2. FOR GEOMETRIC INFORMATION, SEE SHEETS 3 TO 7.
 3. PLACE BARRIER REFLECTORS ALONG THE MEDIAN BARRIER ALONG I.R. 76/I.R. 77 IN THE EB/WB & SB/NB DIRECTION FROM THE VERNON ODOM BLVD. INTERCHANGE TO THE PRINCETON ST. OVERPASS.
 4. PLACE RPMS ALONG EDGE LINES AND LANE LINES ALONG I.R. 76/I.R. 77 IN THE EB/WB & SB/NB DIRECTION FROM THE VERNON ODOM BLVD. INTERCHANGE TO THE PRINCETON ST. OVERPASS, INCLUDING ALL RAMPS.

P:\102329_SUM-76_77\Design\Traffic\Sheets\102329_TP003.dgn 10/24/2020 11:47:17 AM milutes

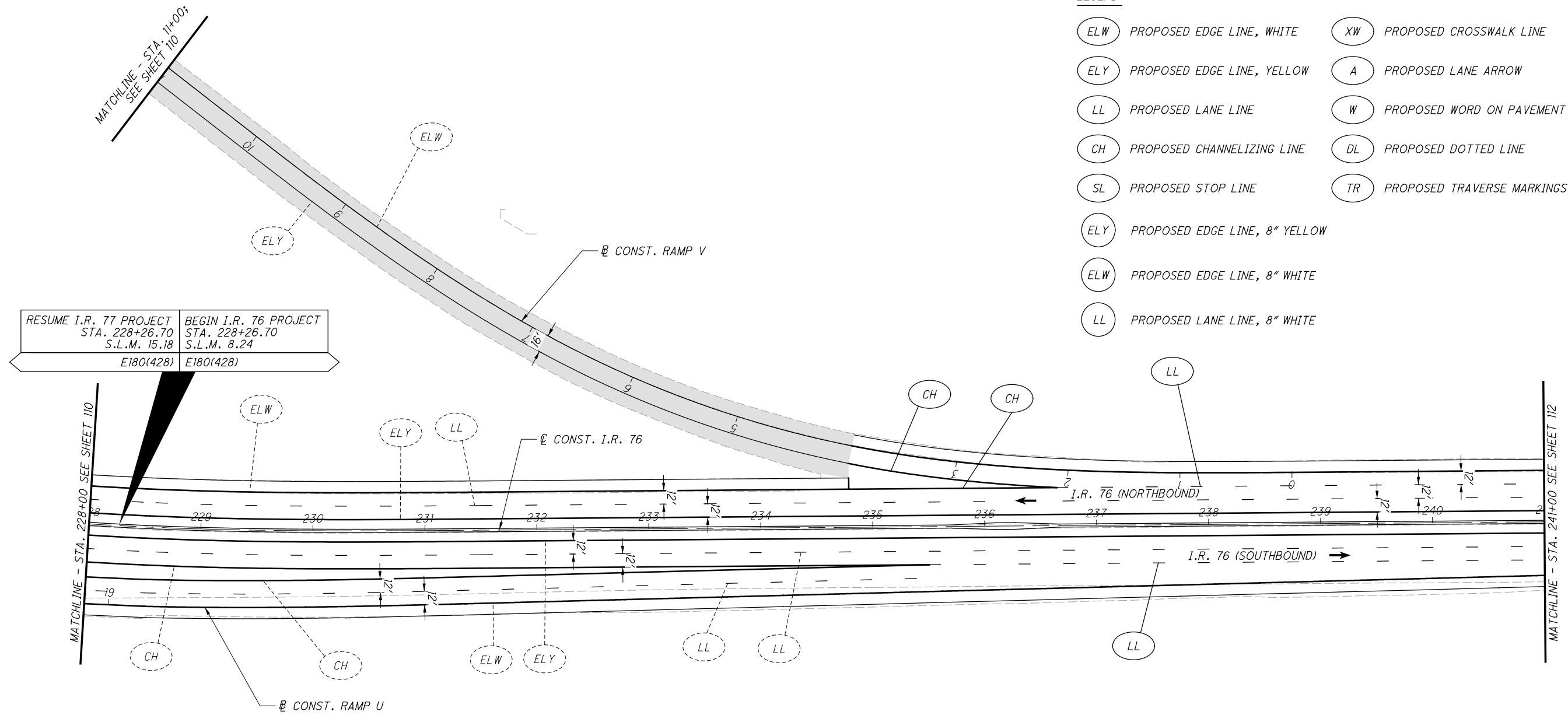

NOTES:

1. PAVEMENT MARKINGS ARE WHOLLY THE RESPONSIBILITY OF THE DESIGN BUILD TEAM AND ARE SHOWN HERE FOR REFERENCE ONLY.
2. FOR GEOMETRIC INFORMATION, SEE SHEETS 3 TO 7.
3. PLACE BARRIER REFLECTORS ALONG THE MEDIAN BARRIER ALONG I.R. 76/I.R. 77 IN THE EB/WB & SB/NB DIRECTION FROM THE VERNON ODOM BLVD. INTERCHANGE TO THE PRINCETON ST. OVERPASS.
4. PLACE RPMS ALONG EDGE LINES AND LANE LINES ALONG I.R. 76/I.R. 77 IN THE EB/WB & SB/NB DIRECTION FROM THE VERNON ODOM BLVD. INTERCHANGE TO THE PRINCETON ST. OVERPASS, INCLUDING ALL RAMPS.

LEGEND:

- | | |
|-------------------------------------|---------------------------------|
| (ELW) PROPOSED EDGE LINE, WHITE | (XW) PROPOSED CROSSWALK LINE |
| (ELY) PROPOSED EDGE LINE, YELLOW | (A) PROPOSED LANE ARROW |
| (LL) PROPOSED LANE LINE | (W) PROPOSED WORD ON PAVEMENT |
| (CH) PROPOSED CHANNELIZING LINE | (DL) PROPOSED DOTTED LINE |
| (SL) PROPOSED STOP LINE | (TR) PROPOSED TRAVERSE MARKINGS |
| (ELY) PROPOSED EDGE LINE, 8" YELLOW | |
| (ELW) PROPOSED EDGE LINE, 8" WHITE | |
| (LL) PROPOSED LANE LINE, 8" WHITE | |

N

0 50 100
HORIZONTAL
SCALE IN FEET

CALCULATED
KRM
CHECKED
MLL

TRAFFIC CONTROL PLAN - I.R. 77 / I.R. 76
STA. 228+00 TO STA. 241+00

**SUM-76 / 77 / 8-
8.24 / 9.74 / 0.00**

NOTES:

1. PAVEMENT MARKINGS ARE WHOLLY THE RESPONSIBILITY OF THE DESIGN BUILD TEAM AND ARE SHOWN HERE FOR REFERENCE ONLY.

2. FOR GEOMETRIC INFORMATION, SEE SHEETS 3 TO 7.

3. PLACE BARRIER REFLECTORS ALONG THE MEDIAN BARRIER ALONG I.R. 76/I.R. 77 IN THE EB/WB & SB/NB DIRECTION FROM THE VERNON ODOM BLVD. INTERCHANGE TO THE PRINCETON ST. OVERPASS.

4. PLACE RPMS ALONG EDGE LINES AND LANE LINES ALONG I.R. 76/I.R. 77 IN THE EB/WB & SB/NB DIRECTION FROM THE VERNON ODOM BLVD. INTERCHANGE TO THE PRINCETON ST. OVERPASS, INCLUDING ALL RAMPS.

LEGEND:

- | | |
|-------------------------------------|---------------------------------|
| (ELW) PROPOSED EDGE LINE, WHITE | (XW) PROPOSED CROSSWALK LINE |
| (ELY) PROPOSED EDGE LINE, YELLOW | (A) PROPOSED LANE ARROW |
| (LL) PROPOSED LANE LINE | (W) PROPOSED WORD ON PAVEMENT |
| (CH) PROPOSED CHANNELIZING LINE | (DL) PROPOSED DOTTED LINE |
| (SL) PROPOSED STOP LINE | (TR) PROPOSED TRAVERSE MARKINGS |
| (ELY) PROPOSED EDGE LINE, 8" YELLOW | |
| (ELW) PROPOSED EDGE LINE, 8" WHITE | |
| (LL) PROPOSED LANE LINE, 8" WHITE | |

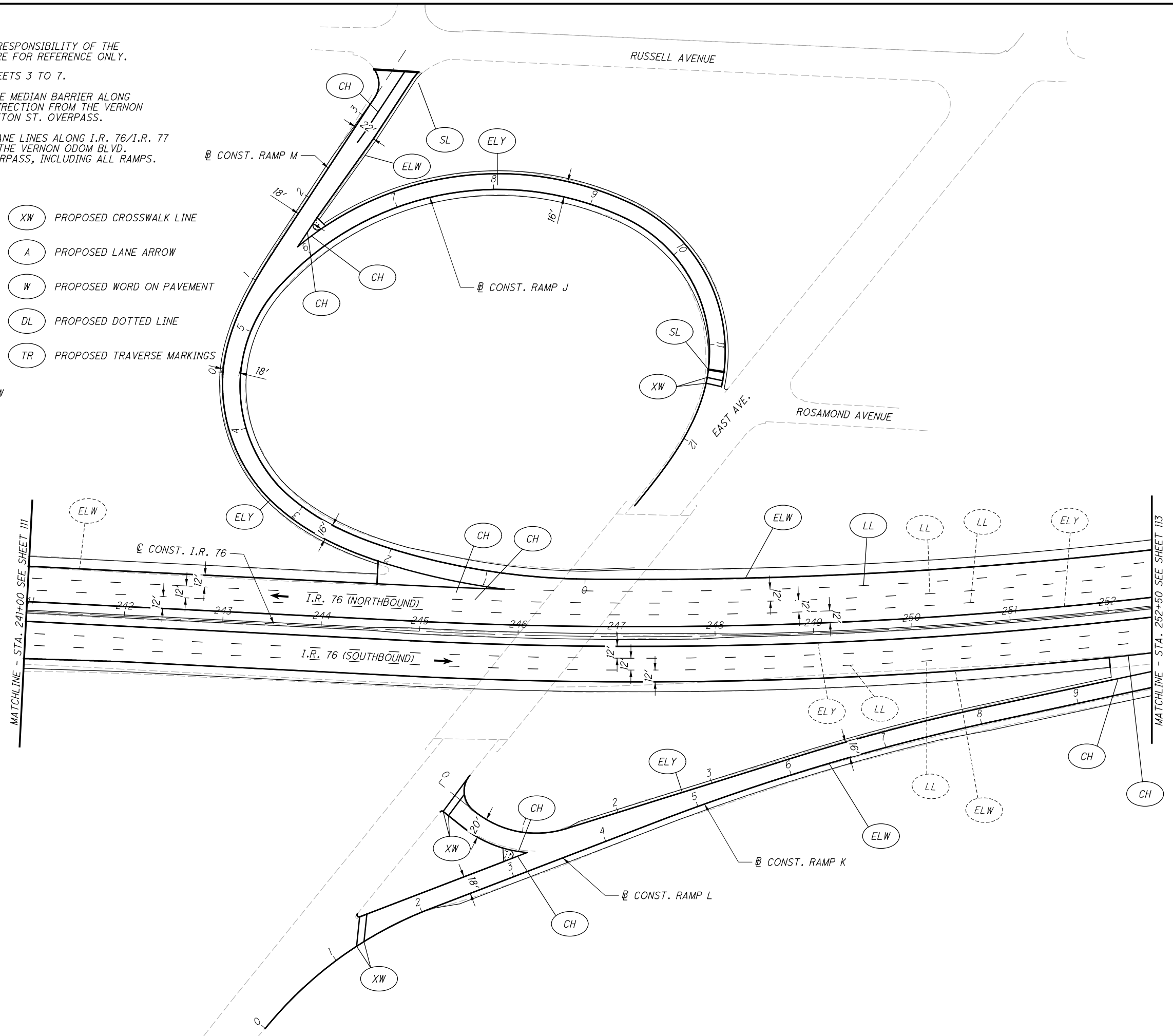



 0 50 100

 HORIZONTAL SCALE IN FEET

 CALCULATED MLL

 CHECKED JTJ

TRAFFIC CONTROL PLAN - I.R. 76
STA. 241+00 TO STA. 252+50

SUM-76/77/8-
8.24/9.74/0.00

P:\102329_SUM-76_77\Design\Traffic\Sheets\02329_TPI01.dgn 10/21/2020 11:47:20 AM mlufes

NOTES:

1. PAVEMENT MARKINGS ARE WHOLLY THE RESPONSIBILITY OF THE DESIGN BUILD TEAM AND ARE SHOWN HERE FOR REFERENCE ONLY.
2. FOR GEOMETRIC INFORMATION, SEE SHEETS 3 TO 7.
3. PLACE BARRIER REFLECTORS ALONG THE MEDIAN BARRIER ALONG I.R. 76/I.R. 77 IN THE EB/WB & SB/NB DIRECTION FROM THE VERNON ODOM BLVD. INTERCHANGE TO THE PRINCETON ST. OVERPASS.
4. PLACE RPMS ALONG EDGE LINES AND LANE LINES ALONG I.R. 76/I.R. 77 IN THE EB/WB & SB/NB DIRECTION FROM THE VERNON ODOM BLVD. INTERCHANGE TO THE PRINCETON ST. OVERPASS, INCLUDING ALL RAMP.

LEGEND:

- | | |
|-------------------------------------|---------------------------------|
| (ELW) PROPOSED EDGE LINE, WHITE | (XW) PROPOSED CROSSWALK LINE |
| (ELY) PROPOSED EDGE LINE, YELLOW | (A) PROPOSED LANE ARROW |
| (LL) PROPOSED LANE LINE | (W) PROPOSED WORD ON PAVEMENT |
| (CH) PROPOSED CHANNELIZING LINE | (DL) PROPOSED DOTTED LINE |
| (SL) PROPOSED STOP LINE | (TR) PROPOSED TRAVERSE MARKINGS |
| (ELY) PROPOSED EDGE LINE, 8" YELLOW | |
| (ELW) PROPOSED EDGE LINE, 8" WHITE | |
| (LL) PROPOSED LANE LINE, 8" WHITE | |

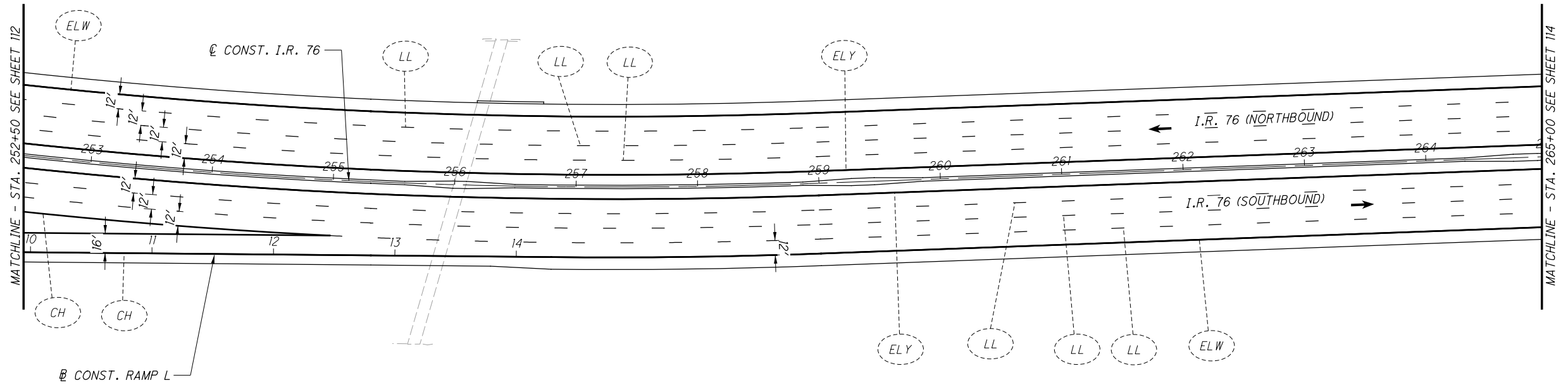

CALCULATED
M.L.L.
CHECKED
J.T.W.

0 50 100
HORIZONTAL
SCALE IN FEET

TRAFFIC CONTROL PLAN - I.R. 76
STA. 252+50 TO STA. 265+00

SUM-76/77/8-
8.24/9.74/0.00

NOTES:

1. PAVEMENT MARKINGS ARE WHOLLY THE RESPONSIBILITY OF THE DESIGN BUILD TEAM AND ARE SHOWN HERE FOR REFERENCE ONLY.
2. FOR GEOMETRIC INFORMATION, SEE SHEETS 3 TO 7.
3. PLACE BARRIER REFLECTORS ALONG THE MEDIAN BARRIER ALONG I.R. 76/I.R. 77 IN THE EB/WB & SB/NB DIRECTION FROM THE VERNON ODOM BLVD. INTERCHANGE TO THE PRINCETON ST. OVERPASS.
4. PLACE RPMS ALONG EDGE LINES AND LANE LINES ALONG I.R. 76/I.R. 77 IN THE EB/WB & SB/NB DIRECTION FROM THE VERNON ODOM BLVD. INTERCHANGE TO THE PRINCETON ST. OVERPASS, INCLUDING ALL RAMP.

LEGEND:

- | | |
|-------------------------------------|-----------------------------------|
| (ELW) PROPOSED EDGE LINE, WHITE | (XW) PROPOSED CROSSWALK LINE |
| (ELY) PROPOSED EDGE LINE, YELLOW | (A) PROPOSED LANE ARROW |
| (LL) PROPOSED LANE LINE | (W) PROPOSED WORD ON PAVEMENT |
| (CH) PROPOSED CHANNELIZING LINE | (DL) PROPOSED DOTTED LINE |
| (SL) PROPOSED STOP LINE | (TR) PROPOSED TRAVERSE MARKINGS |
| (ELY) PROPOSED EDGE LINE, 8" YELLOW | (LL) PROPOSED LANE LINE, 8" WHITE |
| (ELW) PROPOSED EDGE LINE, 8" WHITE | |

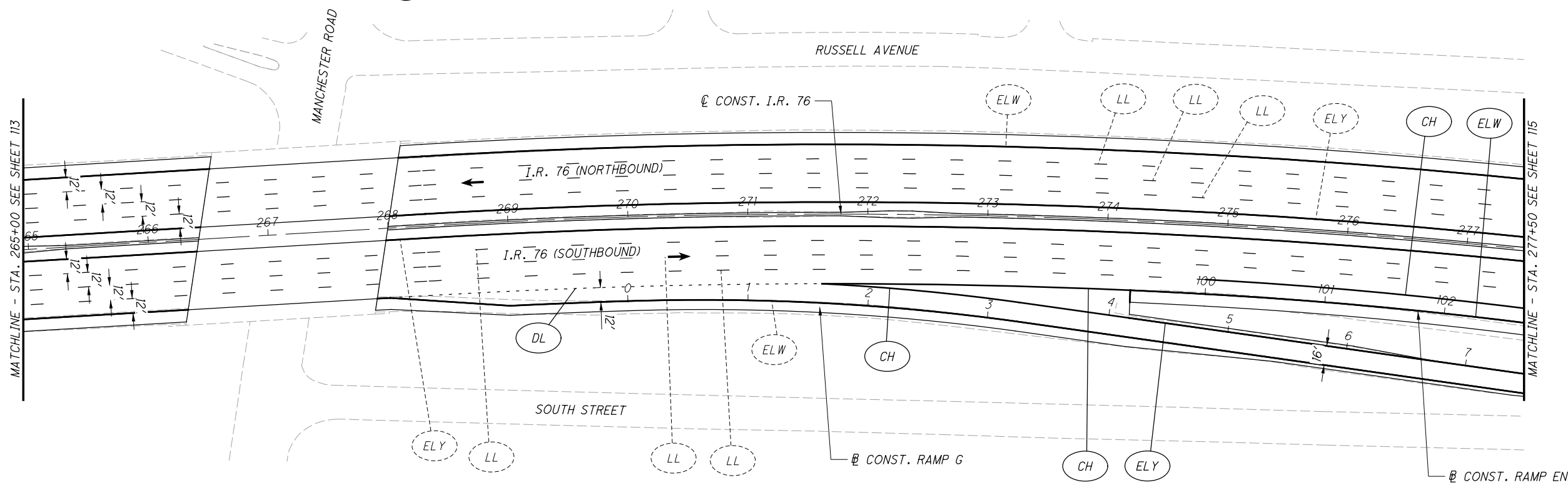

CALCULATED
M.L.L.
CHECKED
J.T.W.

0 50 100
HORIZONTAL
SCALE IN FEET

TRAFFIC CONTROL PLAN - I.R. 76
STA. 265+00 TO STA. 277+50

SUM-76/77/8-
8.24/9.74/0.00

P:\02329_SUM-76_77\Design\Traffic\Sheets\02329_TPO3.dgn 8/7/2020 11:41:22 AM mlutes

NOTES:

- PAVEMENT MARKINGS ARE WHOLLY THE RESPONSIBILITY OF THE DESIGN BUILD TEAM AND ARE SHOWN HERE FOR REFERENCE ONLY.
- FOR GEOMETRIC INFORMATION, SEE SHEETS 3 TO 7.
- PLACE BARRIER REFLECTORS ALONG THE MEDIAN BARRIER ALONG I.R. 76/I.R. 77 IN THE EB/WB & SB/NB DIRECTION FROM THE VERNON ODOM BLVD. INTERCHANGE TO THE PRINCETON ST. OVERPASS.
- PLACE RPMS ALONG EDGE LINES AND LANE LINES ALONG I.R. 76/I.R. 77 IN THE EB/WB & SB/NB DIRECTION FROM THE VERNON ODOM BLVD. INTERCHANGE TO THE PRINCETON ST. OVERPASS, INCLUDING ALL RAMP.

LEGEND:

- | | |
|-------------------------------------|-----------------------------------|
| (ELW) PROPOSED EDGE LINE, WHITE | (XW) PROPOSED CROSSWALK LINE |
| (ELY) PROPOSED EDGE LINE, YELLOW | (A) PROPOSED LANE ARROW |
| (LL) PROPOSED LANE LINE | (W) PROPOSED WORD ON PAVEMENT |
| (CH) PROPOSED CHANNELIZING LINE | (DL) PROPOSED DOTTED LINE |
| (SL) PROPOSED STOP LINE | (TR) PROPOSED TRAVERSE MARKINGS |
| (ELY) PROPOSED EDGE LINE, 8" YELLOW | (LL) PROPOSED LANE LINE, 8" WHITE |
| (ELW) PROPOSED EDGE LINE, 8" WHITE | |

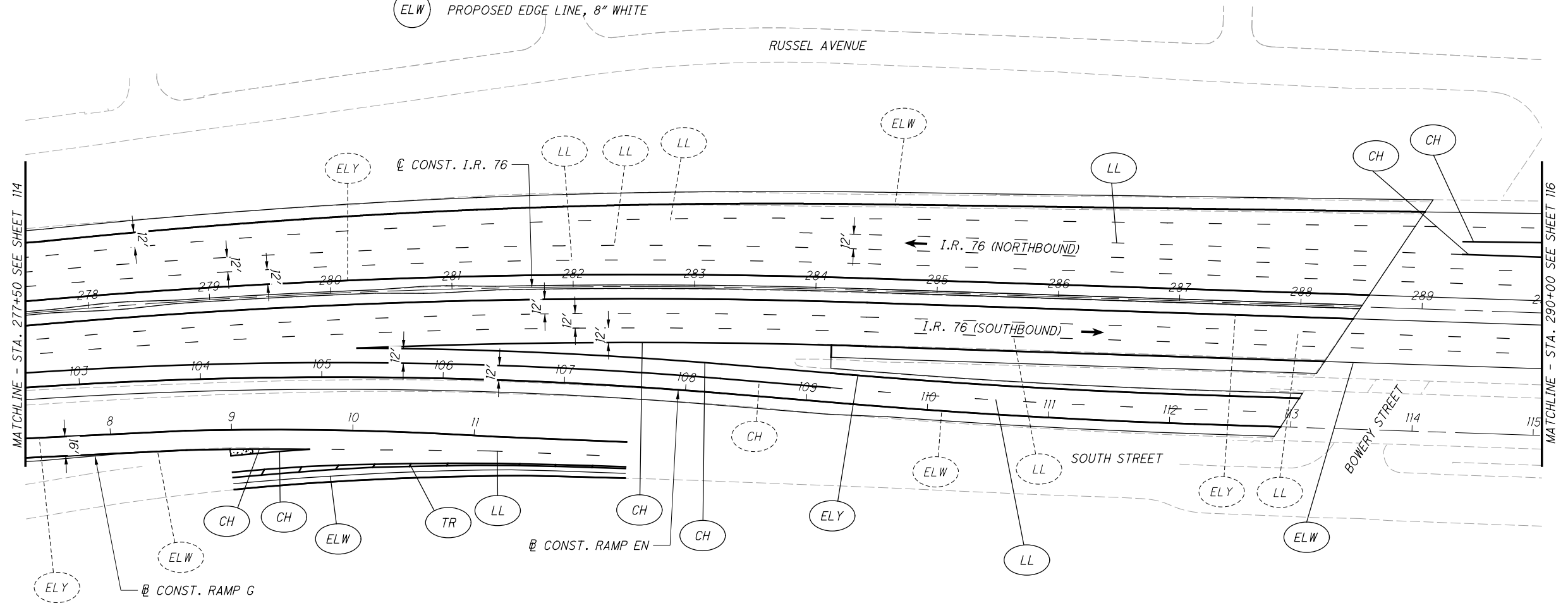

CALCULATED
M.L.L.
CHECKED
J.T.W.

0 50 100
HORIZONTAL
SCALE IN FEET

**TRAFFIC CONTROL PLAN - I.R. 76
STA. 277+50 TO STA. 290+00**

**SUM-76/77/8-
8.24/9.74/0.00**

P:\02329_SUM-76_77\Design\Traffic\Sheets\02329_TPI04.dgn 8/7/2020 11:41:24 AM mlutes

NOTES:

1. PAVEMENT MARKINGS ARE WHOLLY THE RESPONSIBILITY OF THE DESIGN BUILD TEAM AND ARE SHOWN HERE FOR REFERENCE ONLY.
2. FOR GEOMETRIC INFORMATION, SEE SHEETS 3 TO 7.
3. PLACE BARRIER REFLECTORS ALONG THE MEDIAN BARRIER ALONG I.R. 76/I.R. 77 IN THE EB/WB & SB/NB DIRECTION FROM THE VERNON ODOM BLVD. INTERCHANGE TO THE PRINCETON ST. OVERPASS.
4. PLACE RPMS ALONG EDGE LINES AND LANE LINES ALONG I.R. 76/I.R. 77 IN THE EB/WB & SB/NB DIRECTION FROM THE VERNON ODOM BLVD. INTERCHANGE TO THE PRINCETON ST. OVERPASS, INCLUDING ALL RAMPS.

LEGEND:

- | | |
|-------------------------------------|-----------------------------------|
| (ELW) PROPOSED EDGE LINE, WHITE | (XW) PROPOSED CROSSWALK LINE |
| (ELY) PROPOSED EDGE LINE, YELLOW | (A) PROPOSED LANE ARROW |
| (LL) PROPOSED LANE LINE | (W) PROPOSED WORD ON PAVEMENT |
| (CH) PROPOSED CHANNELIZING LINE | (DL) PROPOSED DOTTED LINE |
| (SL) PROPOSED STOP LINE | (TR) PROPOSED TRAVERSE MARKINGS |
| (ELY) PROPOSED EDGE LINE, 8" YELLOW | (LL) PROPOSED LANE LINE, 8" WHITE |
| (ELW) PROPOSED EDGE LINE, 8" WHITE | |

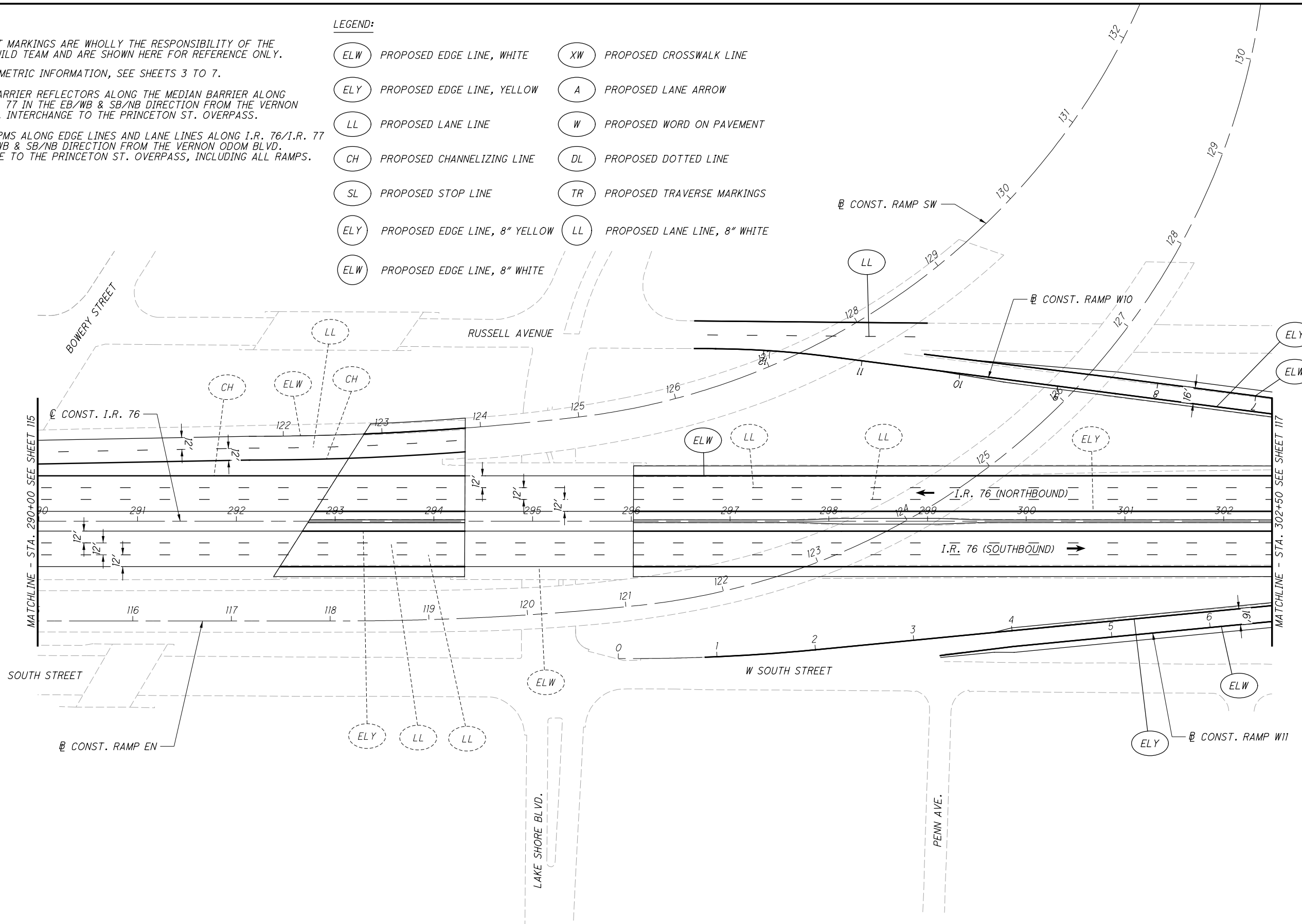

CALCULATED
M.L.L.
CHECKED
J.T.W.

0 50 100
25
HORIZONTAL
SCALE IN FEET

**TRAFFIC CONTROL PLAN - I.R. 76
STA. 290+00 TO STA. 302+50**

**SUM-76 / 77 / 8-
8.24 / 9.74 / 0.00**

P:\02329_SUM-76_77\Design\Traffic\Sheets\02329_TPO5.dgn 10/21/20 11:41:25 AM mlutes

NOTES:

1. PAVEMENT MARKINGS ARE WHOLLY THE RESPONSIBILITY OF THE DESIGN BUILD TEAM AND ARE SHOWN HERE FOR REFERENCE ONLY.
2. FOR GEOMETRIC INFORMATION, SEE SHEETS 3 TO 7.
3. PLACE BARRIER REFLECTORS ALONG THE MEDIAN BARRIER ALONG I.R. 76/I.R. 77 IN THE EB/WB & SB/NB DIRECTION FROM THE VERNON ODOM BLVD. INTERCHANGE TO THE PRINCETON ST. OVERPASS.
4. PLACE RPMS ALONG EDGE LINES AND LANE LINES ALONG I.R. 76/I.R. 77 IN THE EB/WB & SB/NB DIRECTION FROM THE VERNON ODOM BLVD. INTERCHANGE TO THE PRINCETON ST. OVERPASS, INCLUDING ALL RAMPS.

LEGEND:

- | | |
|-------------------------------------|-----------------------------------|
| (ELW) PROPOSED EDGE LINE, WHITE | (XW) PROPOSED CROSSWALK LINE |
| (ELY) PROPOSED EDGE LINE, YELLOW | (A) PROPOSED LANE ARROW |
| (LL) PROPOSED LANE LINE | (W) PROPOSED WORD ON PAVEMENT |
| (CH) PROPOSED CHANNELIZING LINE | (DL) PROPOSED DOTTED LINE |
| (SL) PROPOSED STOP LINE | (TR) PROPOSED TRAVERSE MARKINGS |
| (ELY) PROPOSED EDGE LINE, 8" YELLOW | (LL) PROPOSED LANE LINE, 8" WHITE |
| (ELW) PROPOSED EDGE LINE, 8" WHITE | |

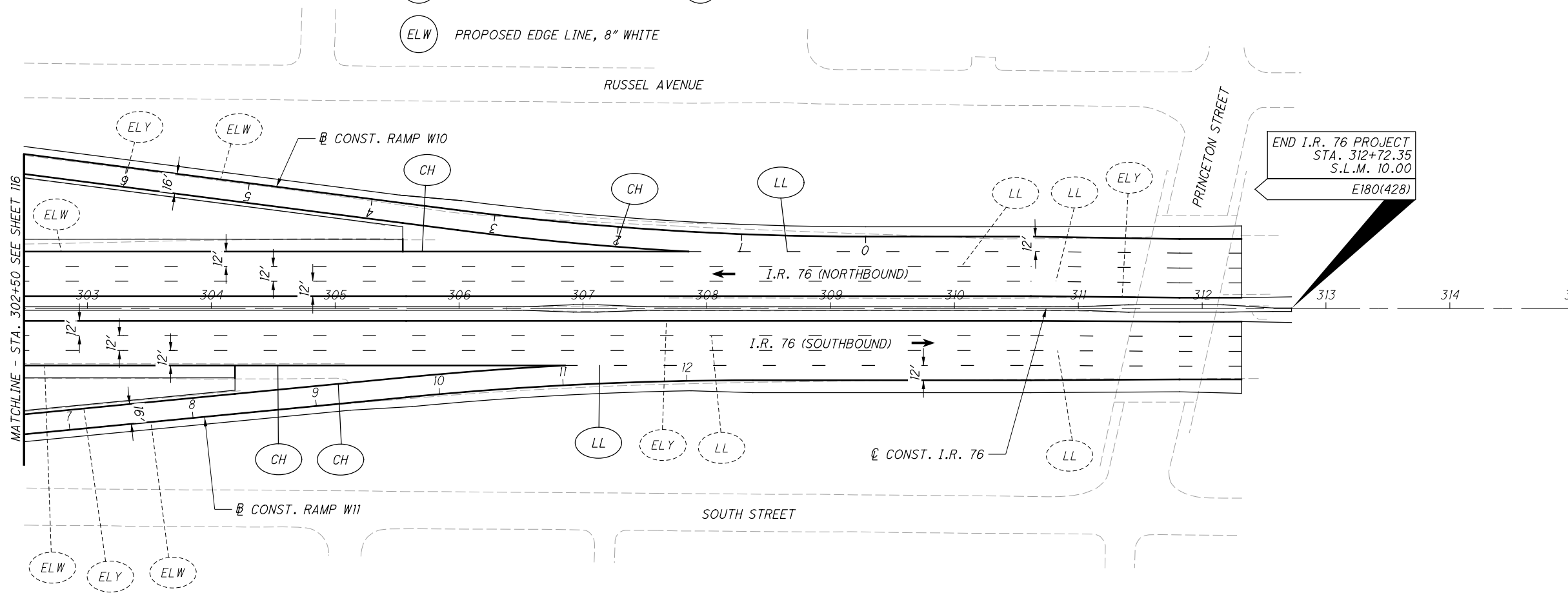

CALCULATED
M.L.L.
CHECKED
J.T.W.

0 50 100
25
HORIZONTAL
SCALE IN FEET

TRAFFIC CONTROL PLAN - I.R. 76
STA. 302+50 TO END I.R. 76 PROJECT

SUM-76/77/8-
8.24/9.74/0.00

NOTES:

1. PAVEMENT MARKINGS ARE WHOLLY THE RESPONSIBILITY OF THE DESIGN BUILD TEAM AND ARE SHOWN HERE FOR REFERENCE ONLY.
2. FOR GEOMETRIC INFORMATION, SEE SHEETS 3 TO 7.
3. PLACE BARRIER REFLECTORS ALONG THE MEDIAN BARRIER ALONG I.R. 76/I.R. 77 IN THE EB/WB & SB/NB DIRECTION FROM THE VERNON ODOM BLVD. INTERCHANGE TO THE PRINCETON ST. OVERPASS.
4. PLACE RPMS ALONG EDGE LINES AND LANE LINES ALONG I.R. 76/I.R. 77 IN THE EB/WB & SB/NB DIRECTION FROM THE VERNON ODOM BLVD. INTERCHANGE TO THE PRINCETON ST. OVERPASS, INCLUDING ALL RAMP.

LEGEND:

- | | |
|-------------------------------------|-----------------------------------|
| (ELW) PROPOSED EDGE LINE, WHITE | (XW) PROPOSED CROSSWALK LINE |
| (ELY) PROPOSED EDGE LINE, YELLOW | (A) PROPOSED LANE ARROW |
| (LL) PROPOSED LANE LINE | (W) PROPOSED WORD ON PAVEMENT |
| (CH) PROPOSED CHANNELIZING LINE | (DL) PROPOSED DOTTED LINE |
| (SL) PROPOSED STOP LINE | (TR) PROPOSED TRAVERSE MARKINGS |
| (ELY) PROPOSED EDGE LINE, 8" YELLOW | (LL) PROPOSED LANE LINE, 8" WHITE |
| (ELW) PROPOSED EDGE LINE, 8" WHITE | |

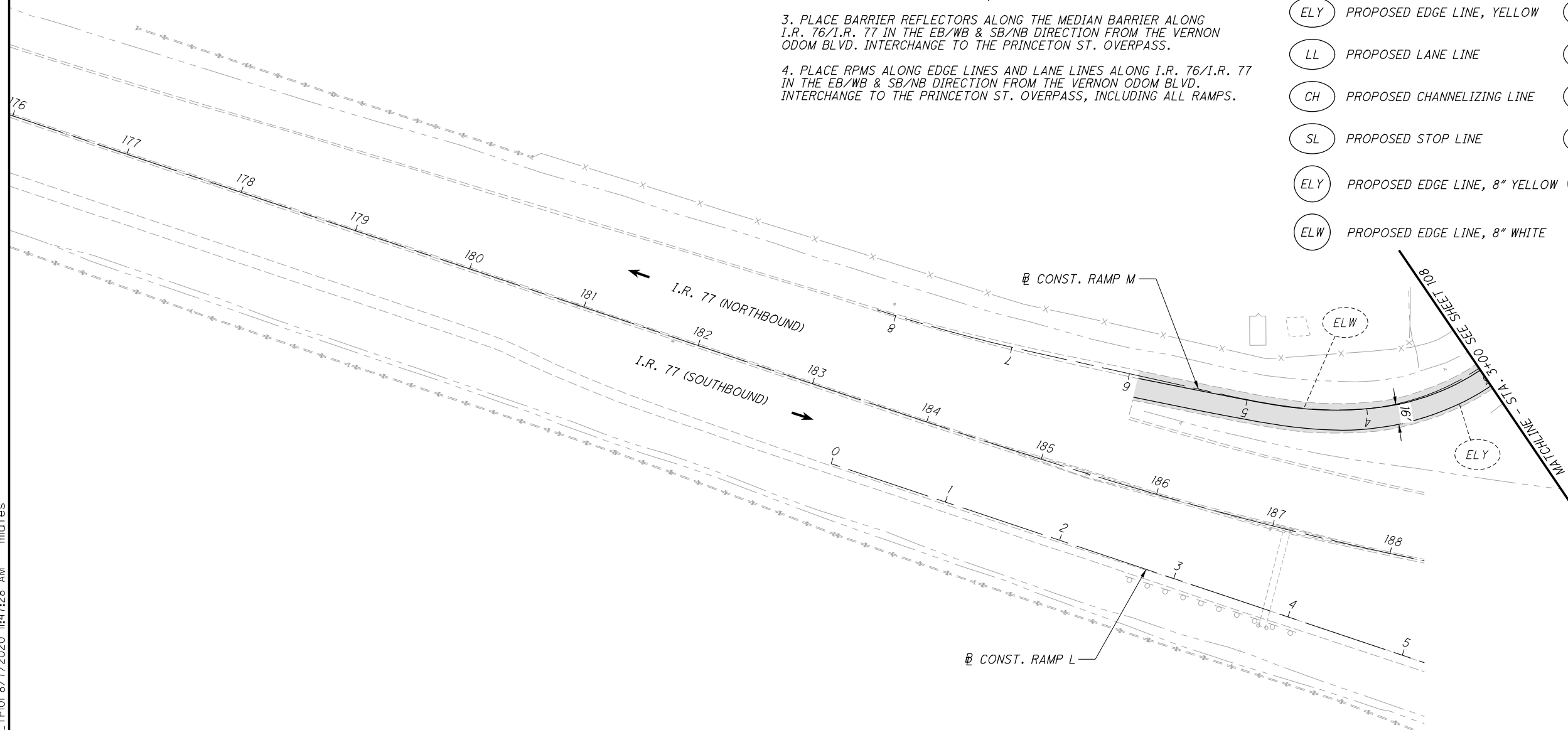

P:\02329_SUM-76_77\Design\Traffic\Sheets\02329_TP001A.dgn 10/21/2020 11:47:28 AM mlutes

**TRAFFIC CONTROL PLAN - RAMP M
BEGIN WORK TO STA. 3+00**

**SUM-76 / 77 / 8-
8.24 / 9.74 / 0.00**

LEGEND:

- | | |
|-------------------------------------|---------------------------------|
| (ELW) PROPOSED EDGE LINE, WHITE | (XW) PROPOSED CROSSWALK LINE |
| (ELY) PROPOSED EDGE LINE, YELLOW | (A) PROPOSED LANE ARROW |
| (LL) PROPOSED LANE LINE | (W) PROPOSED WORD ON PAVEMENT |
| (CH) PROPOSED CHANNELIZING LINE | (DL) PROPOSED DOTTED LINE |
| (SL) PROPOSED STOP LINE | (TR) PROPOSED TRAVERSE MARKINGS |
| (ELY) PROPOSED EDGE LINE, 8" YELLOW | |
| (ELW) PROPOSED EDGE LINE, 8" WHITE | |
| (LL) PROPOSED LANE LINE, 8" WHITE | |

NOTES:

- PAVEMENT MARKINGS ARE WHOLLY THE RESPONSIBILITY OF THE DESIGN BUILD TEAM AND ARE SHOWN HERE FOR REFERENCE ONLY.
- FOR GEOMETRIC INFORMATION, SEE SHEETS 3 TO 7.
- PLACE BARRIER REFLECTORS ALONG THE MEDIAN BARRIER ALONG I.R. 76/I.R. 77 IN THE EB/WB & SB/NB DIRECTION FROM THE VERNON ODOM BLVD. INTERCHANGE TO THE PRINCETON ST. OVERPASS.
- PLACE RPMS ALONG EDGE LINES AND LANE LINES ALONG I.R. 76/I.R. 77 IN THE EB/WB & SB/NB DIRECTION FROM THE VERNON ODOM BLVD. INTERCHANGE TO THE PRINCETON ST. OVERPASS, INCLUDING ALL RAMP.

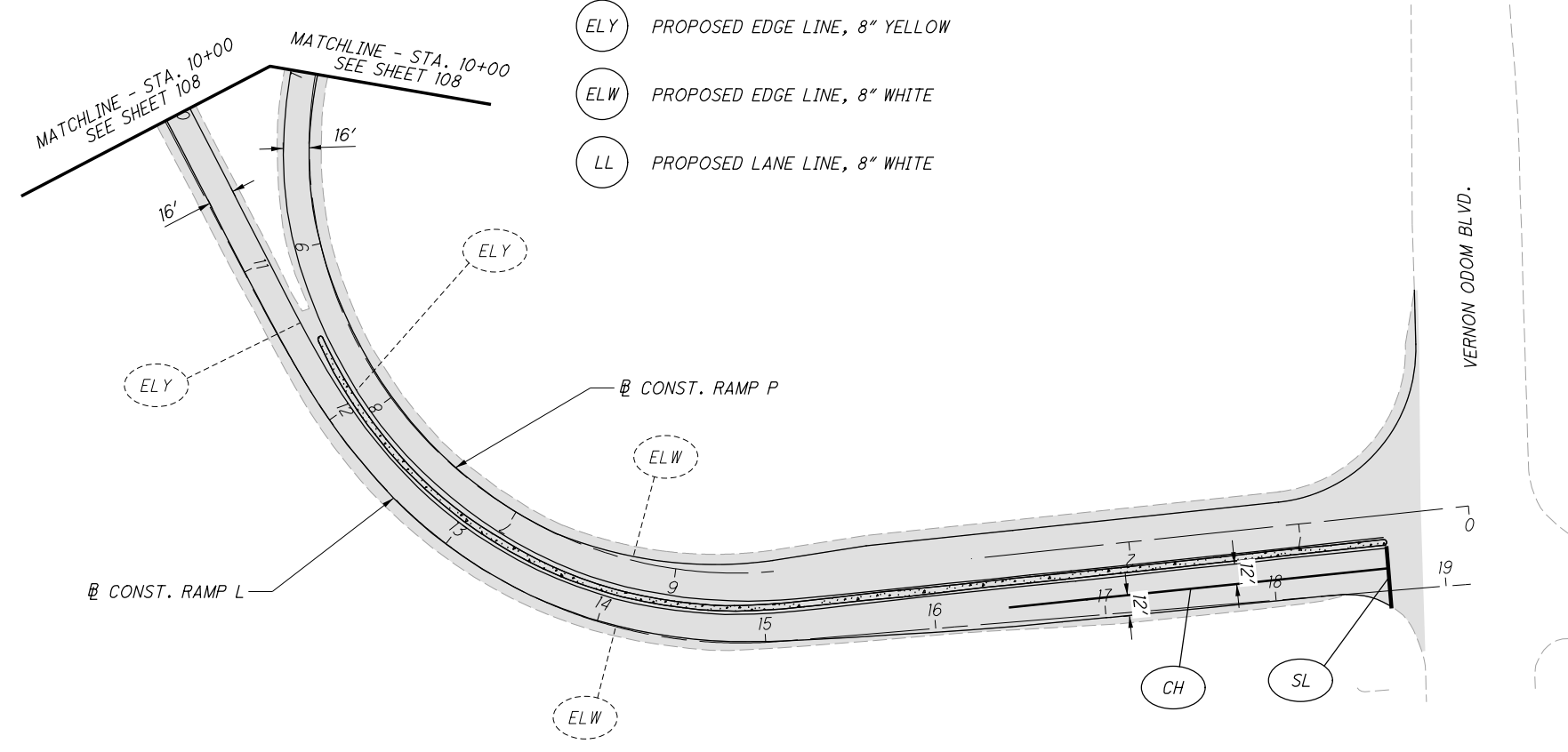

CALCULATED
MILL
CHECKED
JTJW

0 50 100
HORIZONTAL
SCALE IN FEET

**TRAFFIC CONTROL PLAN - RAMP L & RAMP P
STA. 10+00 TO END WORK**

**SUM-76 / 77 / 8-
8.24 / 9.74 / 0.00**

P:\02329_SUM-76_77\Design\Traffic\Sheets\02329_TP00B.dgn 10/21/2020 10:47:29 AM mlutes

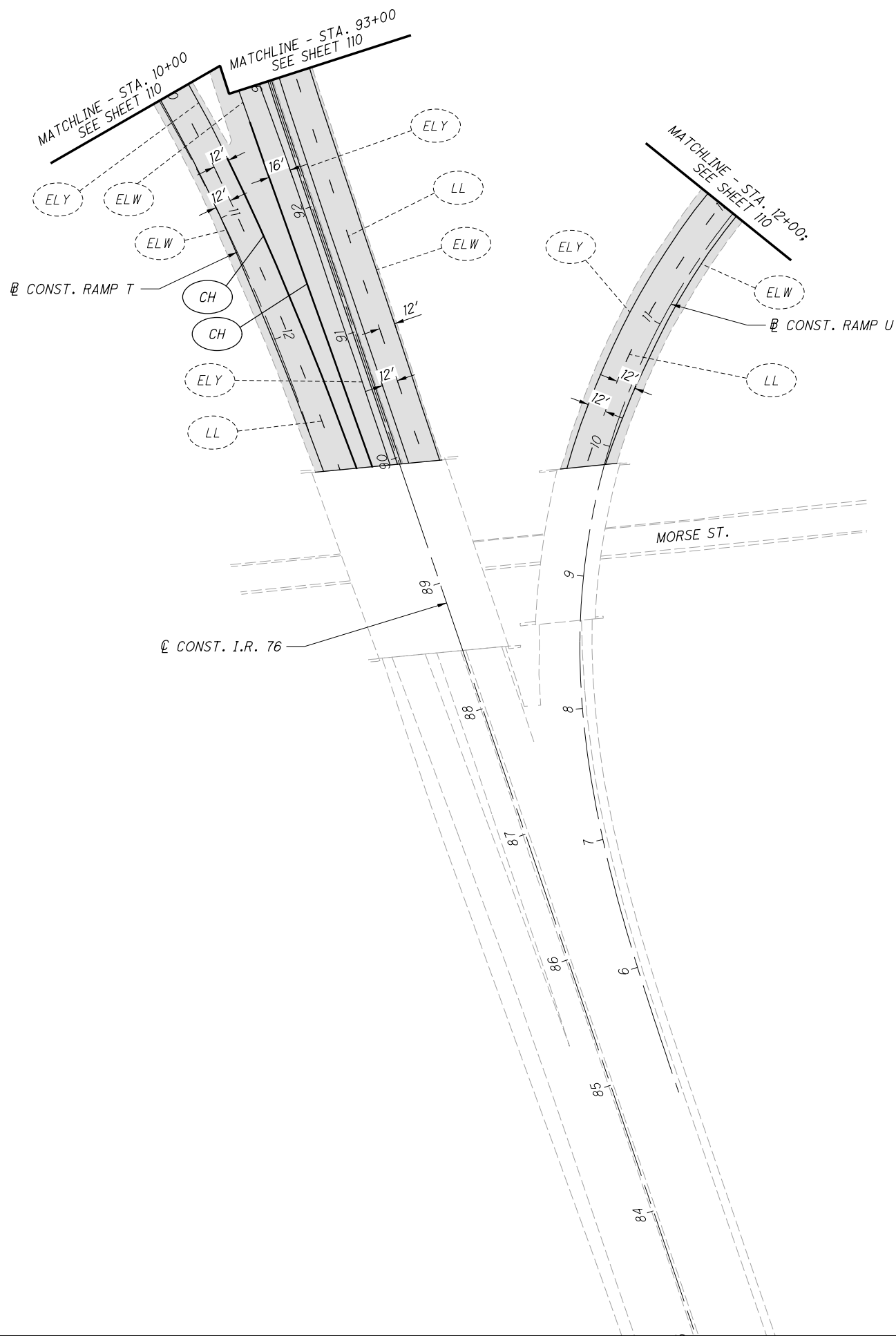

NOTES:

1. PAVEMENT MARKINGS ARE WHOLLY THE RESPONSIBILITY OF THE DESIGN BUILD TEAM AND ARE SHOWN HERE FOR REFERENCE ONLY.
2. FOR GEOMETRIC INFORMATION, SEE SHEETS 3 TO 7.
3. PLACE BARRIER REFLECTORS ALONG THE MEDIAN BARRIER ALONG I.R. 76/I.R. 77 IN THE EB/WB & SB/NB DIRECTION FROM THE VERNON ODOM BLVD. INTERCHANGE TO THE PRINCETON ST. OVERPASS.
4. PLACE RPMS ALONG EDGE LINES AND LANE LINES ALONG I.R. 76/I.R. 77 IN THE EB/WB & SB/NB DIRECTION FROM THE VERNON ODOM BLVD. INTERCHANGE TO THE PRINCETON ST. OVERPASS, INCLUDING ALL RAMPS.

LEGEND:

- | | |
|-------------------------------------|---------------------------------|
| (ELW) PROPOSED EDGE LINE, WHITE | (XW) PROPOSED CROSSWALK LINE |
| (ELY) PROPOSED EDGE LINE, YELLOW | (A) PROPOSED LANE ARROW |
| (LL) PROPOSED LANE LINE | (W) PROPOSED WORD ON PAVEMENT |
| (CH) PROPOSED CHANNELIZING LINE | (DL) PROPOSED DOTTED LINE |
| (SL) PROPOSED STOP LINE | (TR) PROPOSED TRAVERSE MARKINGS |
| (ELY) PROPOSED EDGE LINE, 8" YELLOW | |
| (ELW) PROPOSED EDGE LINE, 8" WHITE | |
| (LL) PROPOSED LANE LINE, 8" WHITE | |

CALCULATED
M.L.L.
CHECKED
J.T.W.

0 25 50 100
HORIZONTAL
SCALE IN FEET

**TRAFFIC CONTROL PLAN - RAMP T & RAMP U
STA. 10+00 TO END WORK**

**SUM-76 / 77 / 8-
8.24 / 9.74 / 0.00**

P:\102329_SUM-76_77\Design\Traffic\Sheets\102329_TP200.dgn 10/21/2020 11:34:09 AM mlutes

NOTES:

1. PAVEMENT MARKINGS ARE WHOLLY THE RESPONSIBILITY OF THE DESIGN BUILD TEAM AND ARE SHOWN HERE FOR REFERENCE ONLY.
2. FOR GEOMETRIC INFORMATION, SEE SHEETS 8 TO 15.
3. PLACE BARRIER REFLECTORS ALONG THE MEDIAN BARRIER ALONG I.R. 77/S.R. 8 IN THE SB/NB DIRECTION FROM THE CARROLL/BUCHTEL INTERCHANGE TO THE I.R. 277/U.S. 224 INTERCHANGE.
4. PLACE RPMS ALONG EDGE LINES AND LANE LINES ALONG I.R. 77/S.R. 8 IN THE SB/NB DIRECTION FROM THE CARROLL/BUCHTEL INTERCHANGE TO THE I.R. 277/U.S. 224 INTERCHANGE, INCLUDING ALL RAMP.

LEGEND:

- | | |
|-------------------------------------|-----------------------------------|
| (ELW) PROPOSED EDGE LINE, WHITE | (XW) PROPOSED CROSSWALK LINE |
| (ELY) PROPOSED EDGE LINE, YELLOW | (A) PROPOSED LANE ARROW |
| (LL) PROPOSED LANE LINE | (W) PROPOSED WORD ON PAVEMENT |
| (CH) PROPOSED CHANNELIZING LINE | (DL) PROPOSED DOTTED LINE |
| (SL) PROPOSED STOP LINE | (TR) PROPOSED TRAVERSE MARKINGS |
| (ELY) PROPOSED EDGE LINE, 8" YELLOW | (LL) PROPOSED LANE LINE, 8" WHITE |
| (ELW) PROPOSED EDGE LINE, 8" WHITE | |

CALCULATED
MLL
CHECKED
JTW

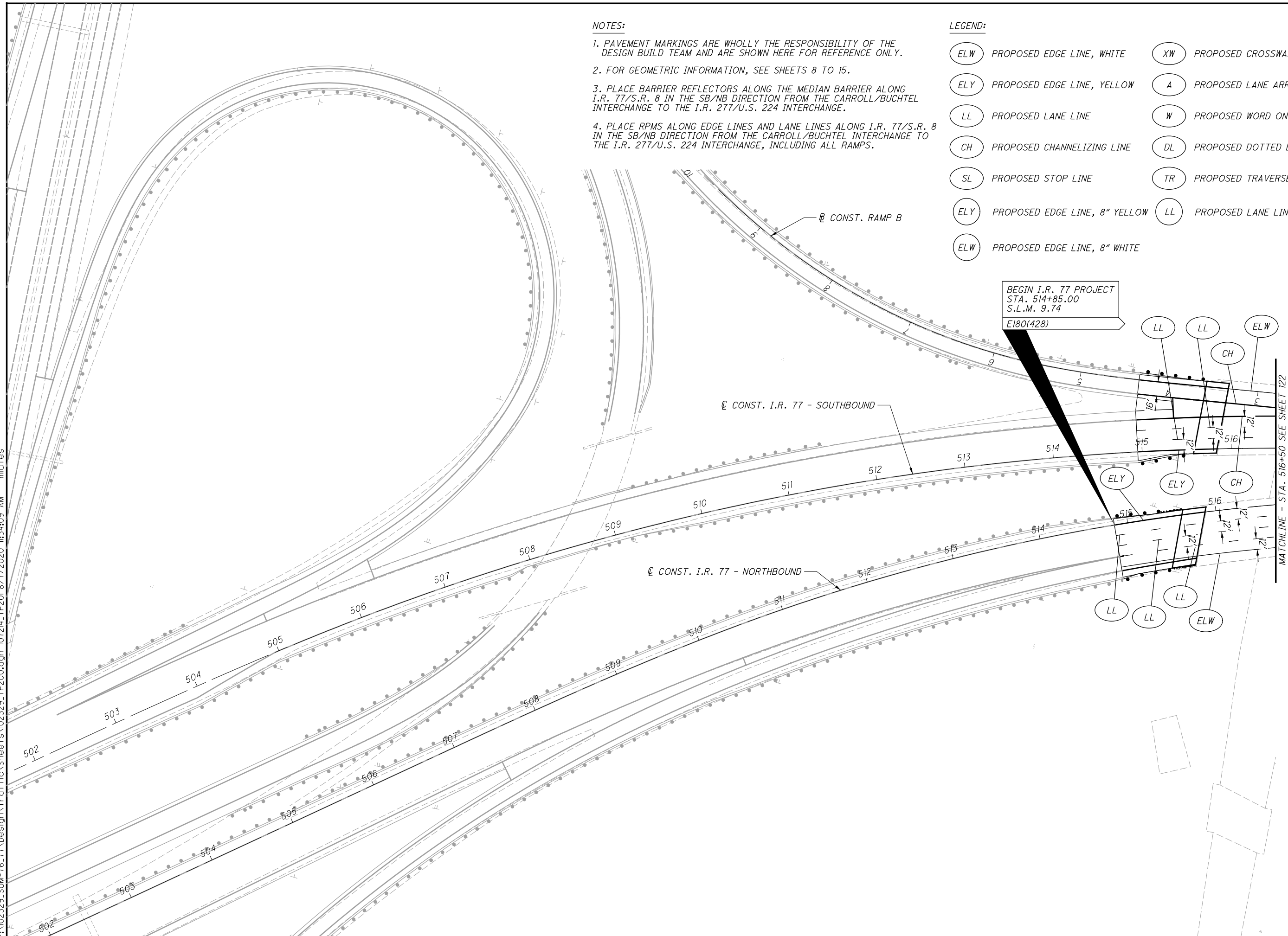

**TRAFFIC CONTROL PLAN - I.R. 77
BEGIN I.R. 77 PROJECT TO STA. 516+50**

**SUM-76 / 77 / 8-
8.24 / 9.74 / 0.00**

NOTES:

1. PAVEMENT MARKINGS ARE WHOLLY THE RESPONSIBILITY OF THE DESIGN BUILD TEAM AND ARE SHOWN HERE FOR REFERENCE ONLY.
2. FOR GEOMETRIC INFORMATION, SEE SHEETS 8 TO 15.
3. PLACE BARRIER REFLECTORS ALONG THE MEDIAN BARRIER ALONG I.R. 77/S.R. 8 IN THE SB/NB DIRECTION FROM THE CARROLL/BUCHTEL INTERCHANGE TO THE I.R. 277/U.S. 224 INTERCHANGE.
4. PLACE RPMS ALONG EDGE LINES AND LANE LINES ALONG I.R. 77/S.R. 8 IN THE SB/NB DIRECTION FROM THE CARROLL/BUCHTEL INTERCHANGE TO THE I.R. 277/U.S. 224 INTERCHANGE, INCLUDING ALL RAMPS.

LEGEND:

- | | |
|-------------------------------------|---------------------------------|
| (ELW) PROPOSED EDGE LINE, WHITE | (XW) PROPOSED CROSSWALK LINE |
| (ELY) PROPOSED EDGE LINE, YELLOW | (A) PROPOSED LANE ARROW |
| (LL) PROPOSED LANE LINE | (W) PROPOSED WORD ON PAVEMENT |
| (CH) PROPOSED CHANNELIZING LINE | (DL) PROPOSED DOTTED LINE |
| (SL) PROPOSED STOP LINE | (TR) PROPOSED TRAVERSE MARKINGS |
| (ELY) PROPOSED EDGE LINE, 8" YELLOW | |
| (ELW) PROPOSED EDGE LINE, 8" WHITE | |
| (LL) PROPOSED LANE LINE, 8" WHITE | |

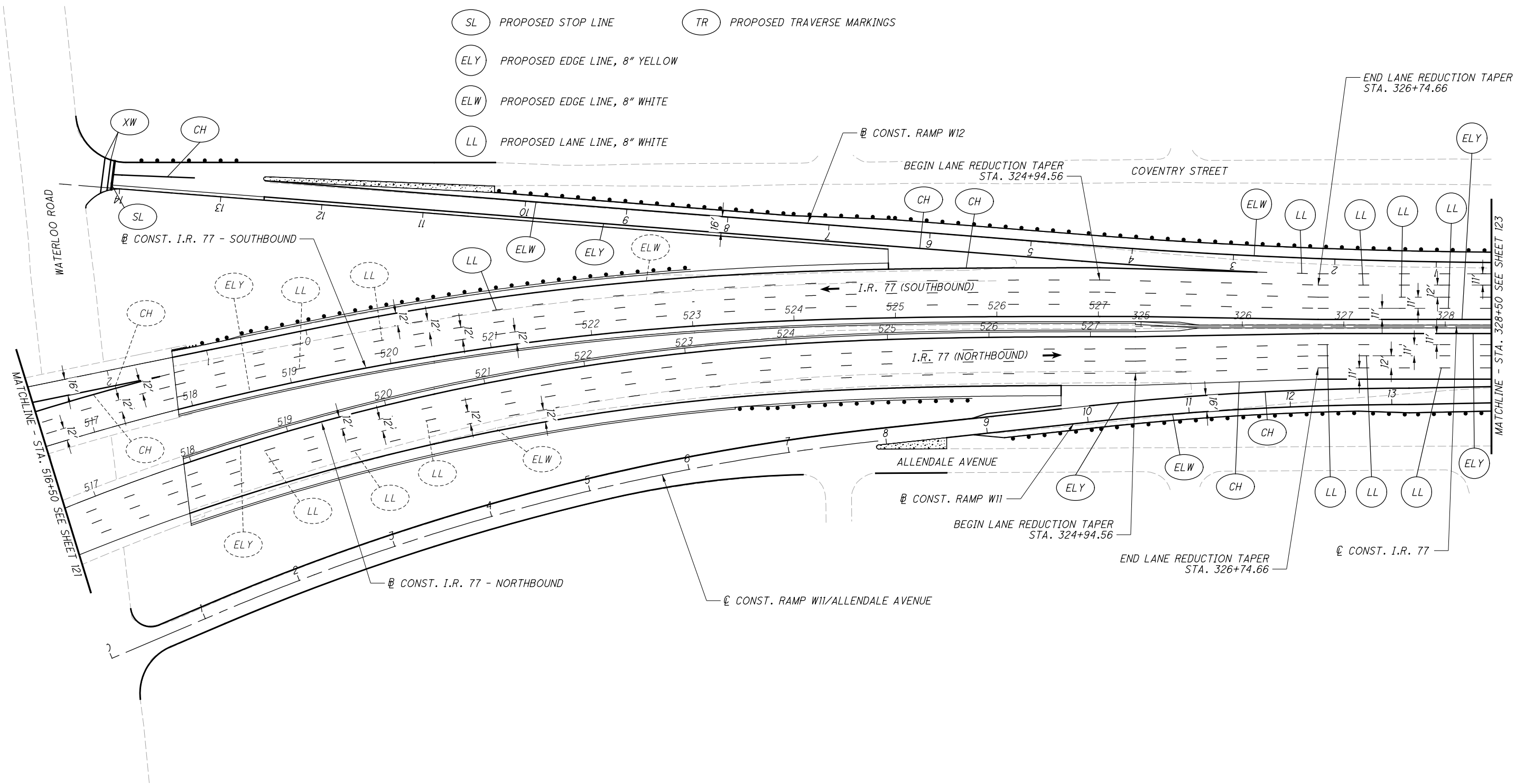





 HORIZONTAL SCALE IN FEET

CALCULATED MLL
 CHECKED JTJ

TRAFFIC CONTROL PLAN - I.R. 77
STA. 516+50 TO STA. 328+50

SUM-76/77/8-
8.24/9.74/0.00

P:\02329_SUM-76_77\Design\Traffic\Sheets\02329_TP201.dgn 10/21/2020 10:34:10 AM miles

NOTES:

1. PAVEMENT MARKINGS ARE WHOLLY THE RESPONSIBILITY OF THE DESIGN BUILD TEAM AND ARE SHOWN HERE FOR REFERENCE ONLY.
2. FOR GEOMETRIC INFORMATION, SEE SHEETS 8 TO 15.
3. PLACE BARRIER REFLECTORS ALONG THE MEDIAN BARRIER ALONG I.R. 77/S.R. 8 IN THE SB/NB DIRECTION FROM THE CARROLL/BUCHTEL INTERCHANGE TO THE I.R. 277/U.S. 224 INTERCHANGE.
4. PLACE RPMS ALONG EDGE LINES AND LANE LINES ALONG I.R. 77/S.R. 8 IN THE SB/NB DIRECTION FROM THE CARROLL/BUCHTEL INTERCHANGE TO THE I.R. 277/U.S. 224 INTERCHANGE, INCLUDING ALL RAMPS.

LEGEND:

- | | |
|-------------------------------------|-----------------------------------|
| (ELW) PROPOSED EDGE LINE, WHITE | (XW) PROPOSED CROSSWALK LINE |
| (ELY) PROPOSED EDGE LINE, YELLOW | (A) PROPOSED LANE ARROW |
| (LL) PROPOSED LANE LINE | (W) PROPOSED WORD ON PAVEMENT |
| (CH) PROPOSED CHANNELIZING LINE | (DL) PROPOSED DOTTED LINE |
| (SL) PROPOSED STOP LINE | (TR) PROPOSED TRAVERSE MARKINGS |
| (ELY) PROPOSED EDGE LINE, 8" YELLOW | (LL) PROPOSED LANE LINE, 8" WHITE |
| (ELW) PROPOSED EDGE LINE, 8" WHITE | |

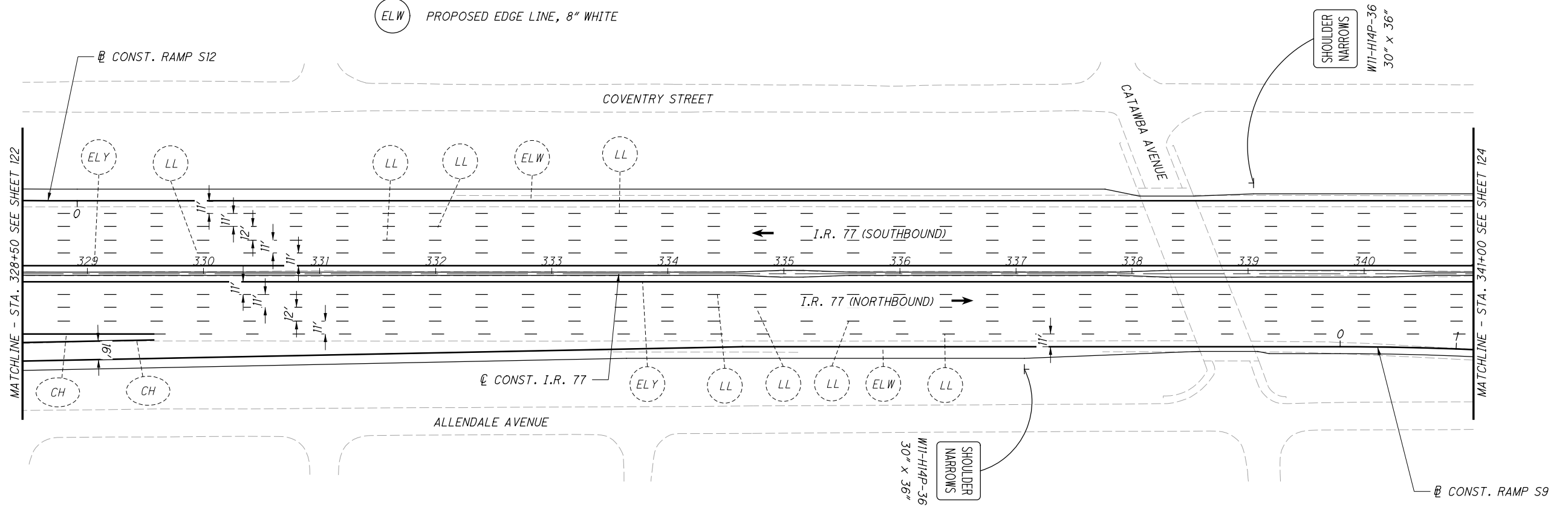

CALCULATED MLL CHECKED JTJ

0 50 100
25
HORIZONTAL SCALE IN FEET

TRAFFIC CONTROL PLAN - I.R. 77
STA. 328+50 TO STA. 341+00

SUM-76 / 77 / 8-
8.24 / 9.74 / 0.00

NOTES:

1. PAVEMENT MARKINGS ARE WHOLLY THE RESPONSIBILITY OF THE DESIGN BUILD TEAM AND ARE SHOWN HERE FOR REFERENCE ONLY.
2. FOR GEOMETRIC INFORMATION, SEE SHEETS 8 TO 15.
3. PLACE BARRIER REFLECTORS ALONG THE MEDIAN BARRIER ALONG I.R. 77/S.R. 8 IN THE SB/NB DIRECTION FROM THE CARROLL/BUCHTEL INTERCHANGE TO THE I.R. 277/U.S. 224 INTERCHANGE.
4. PLACE RPMS ALONG EDGE LINES AND LANE LINES ALONG I.R. 77/S.R. 8 IN THE SB/NB DIRECTION FROM THE CARROLL/BUCHTEL INTERCHANGE TO THE I.R. 277/U.S. 224 INTERCHANGE, INCLUDING ALL RAMP.

LEGEND:

- | | |
|-------------------------------------|-----------------------------------|
| (ELW) PROPOSED EDGE LINE, WHITE | (XW) PROPOSED CROSSWALK LINE |
| (ELY) PROPOSED EDGE LINE, YELLOW | (A) PROPOSED LANE ARROW |
| (LL) PROPOSED LANE LINE | (W) PROPOSED WORD ON PAVEMENT |
| (CH) PROPOSED CHANNELIZING LINE | (DL) PROPOSED DOTTED LINE |
| (SL) PROPOSED STOP LINE | (TR) PROPOSED TRAVERSE MARKINGS |
| (ELY) PROPOSED EDGE LINE, 8" YELLOW | (LL) PROPOSED LANE LINE, 8" WHITE |
| (ELW) PROPOSED EDGE LINE, 8" WHITE | |

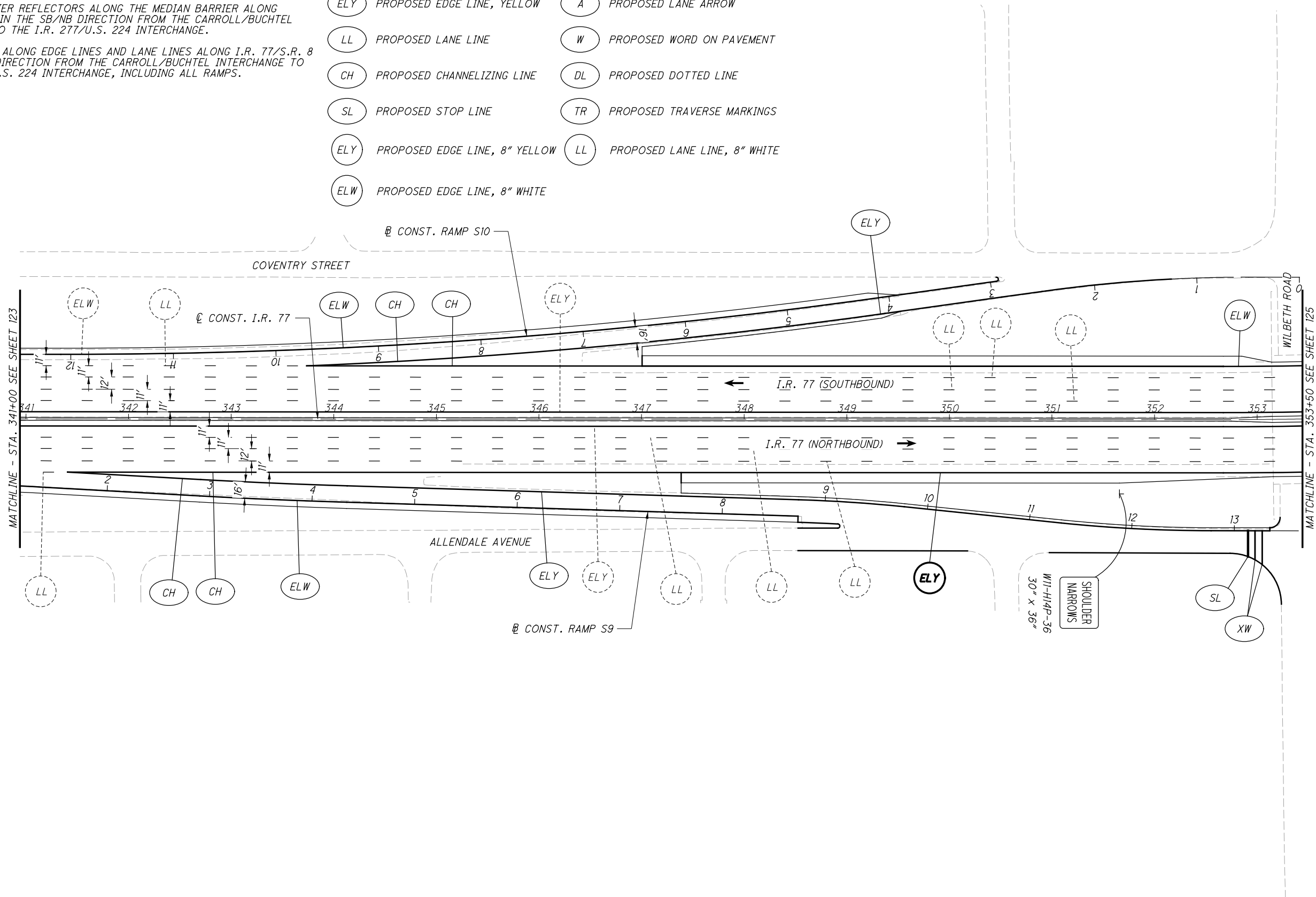





 CALCULATED MLL
 CHECKED JTJ

TRAFFIC CONTROL PLAN - I.R. 77
STA. 341+00 TO STA. 353+50

SUM-76/77/8-
 8.24/9.74/0.00

P:\02329_SUM-76_77\Design\Traffic\Sheets\02329_TP203.dgn 10/21/2020 11:34:13 AM mlutes

NOTES:

1. PAVEMENT MARKINGS ARE WHOLLY THE RESPONSIBILITY OF THE DESIGN BUILD TEAM AND ARE SHOWN HERE FOR REFERENCE ONLY.
2. FOR GEOMETRIC INFORMATION, SEE SHEETS 8 TO 15.
3. PLACE BARRIER REFLECTORS ALONG THE MEDIAN BARRIER ALONG I.R. 77/S.R. 8 IN THE SB/NB DIRECTION FROM THE CARROLL/BUCHTEL INTERCHANGE TO THE I.R. 277/U.S. 224 INTERCHANGE.
4. PLACE RPMS ALONG EDGE LINES AND LANE LINES ALONG I.R. 77/S.R. 8 IN THE SB/NB DIRECTION FROM THE CARROLL/BUCHTEL INTERCHANGE TO THE I.R. 277/U.S. 224 INTERCHANGE, INCLUDING ALL RAMP.

LEGEND:

- | | |
|-------------------------------------|-----------------------------------|
| (ELW) PROPOSED EDGE LINE, WHITE | (XW) PROPOSED CROSSWALK LINE |
| (ELY) PROPOSED EDGE LINE, YELLOW | (A) PROPOSED LANE ARROW |
| (LL) PROPOSED LANE LINE | (W) PROPOSED WORD ON PAVEMENT |
| (CH) PROPOSED CHANNELIZING LINE | (DL) PROPOSED DOTTED LINE |
| (SL) PROPOSED STOP LINE | (TR) PROPOSED TRAVERSE MARKINGS |
| (ELY) PROPOSED EDGE LINE, 8" YELLOW | (LL) PROPOSED LANE LINE, 8" WHITE |
| (ELW) PROPOSED EDGE LINE, 8" WHITE | |

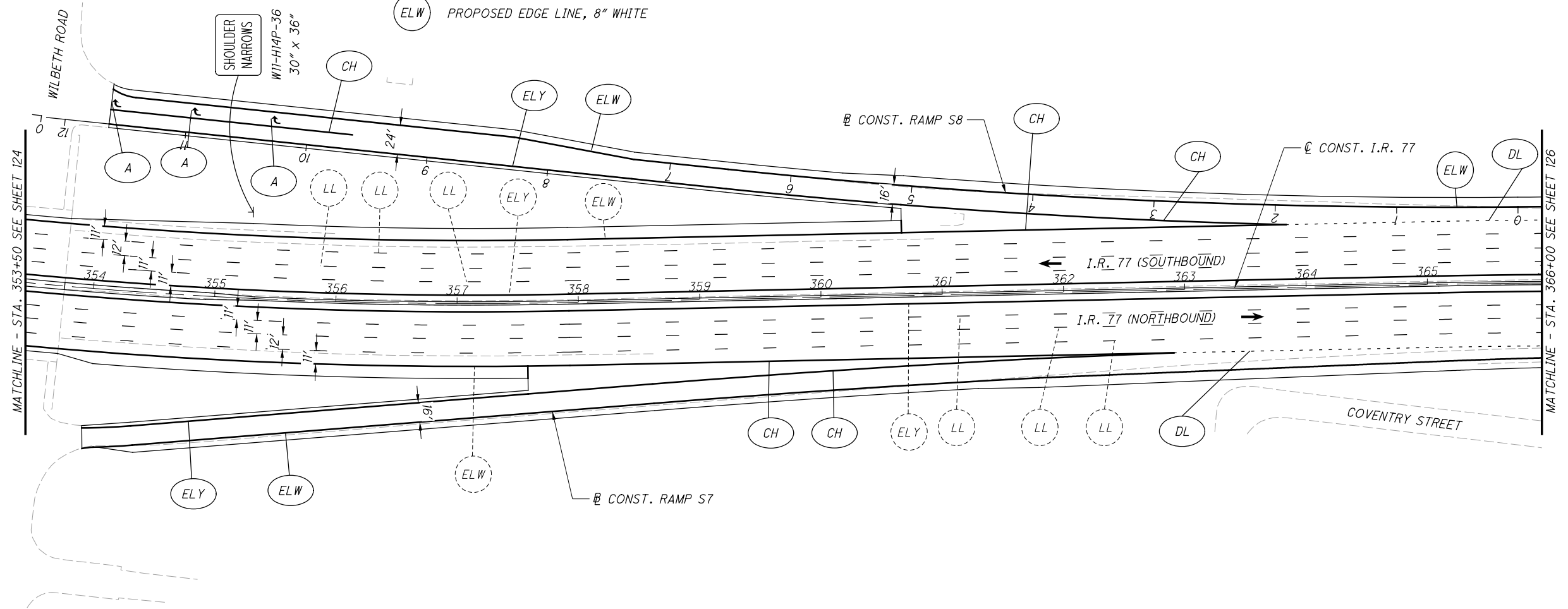





 HORIZONTAL SCALE IN FEET

CALCULATED: MLL
 CHECKED: JTJ

TRAFFIC CONTROL PLAN - I.R. 77
STA. 353+50 TO STA. 366+00

SUM-76/77/8-
 8.24/9.74/0.00

NOTES:

- PAVEMENT MARKINGS ARE WHOLLY THE RESPONSIBILITY OF THE DESIGN BUILD TEAM AND ARE SHOWN HERE FOR REFERENCE ONLY.
- FOR GEOMETRIC INFORMATION, SEE SHEETS 8 TO 15.
- PLACE BARRIER REFLECTORS ALONG THE MEDIAN BARRIER ALONG I.R. 77/S.R. 8 IN THE SB/NB DIRECTION FROM THE CARROLL/BUCHTEL INTERCHANGE TO THE I.R. 277/U.S. 224 INTERCHANGE.
- PLACE RPMS ALONG EDGE LINES AND LANE LINES ALONG I.R. 77/S.R. 8 IN THE SB/NB DIRECTION FROM THE CARROLL/BUCHTEL INTERCHANGE TO THE I.R. 277/U.S. 224 INTERCHANGE, INCLUDING ALL RAMP.

LEGEND:

- | | |
|-------------------------------------|-----------------------------------|
| (ELW) PROPOSED EDGE LINE, WHITE | (XW) PROPOSED CROSSWALK LINE |
| (ELY) PROPOSED EDGE LINE, YELLOW | (A) PROPOSED LANE ARROW |
| (LL) PROPOSED LANE LINE | (W) PROPOSED WORD ON PAVEMENT |
| (CH) PROPOSED CHANNELIZING LINE | (DL) PROPOSED DOTTED LINE |
| (SL) PROPOSED STOP LINE | (TR) PROPOSED TRAVERSE MARKINGS |
| (ELY) PROPOSED EDGE LINE, 8" YELLOW | (LL) PROPOSED LANE LINE, 8" WHITE |
| (ELW) PROPOSED EDGE LINE, 8" WHITE | |

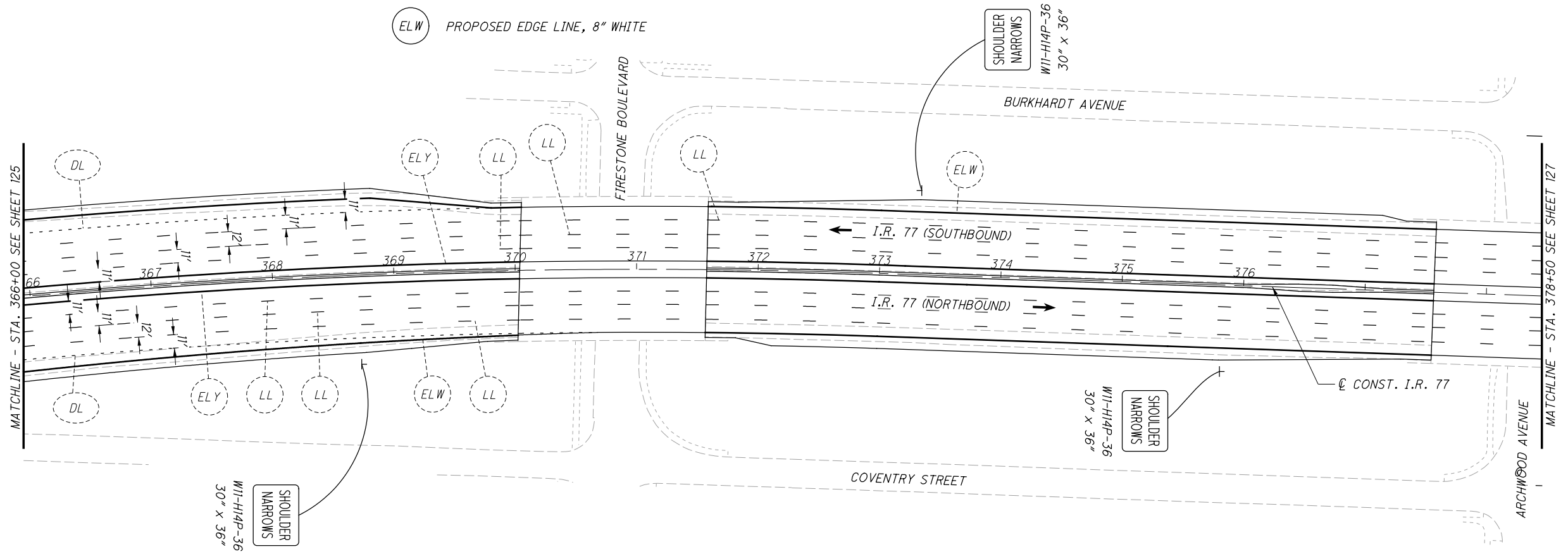





 25 HORIZONTAL SCALE IN FEET

CALCULATED	MLL	CHECKED	JTW
------------	-----	---------	-----

TRAFFIC CONTROL PLAN - I.R. 77
STA. 366+00 TO STA. 378+50

SUM-76 / 77 / 8-
8.24 / 9.74 / 0.00

NOTES:

1. PAVEMENT MARKINGS ARE WHOLLY THE RESPONSIBILITY OF THE DESIGN BUILD TEAM AND ARE SHOWN HERE FOR REFERENCE ONLY.
2. FOR GEOMETRIC INFORMATION, SEE SHEETS 8 TO 15.
3. PLACE BARRIER REFLECTORS ALONG THE MEDIAN BARRIER ALONG I.R. 77/S.R. 8 IN THE SB/NB DIRECTION FROM THE CARROLL/BUCHTEL INTERCHANGE TO THE I.R. 277/U.S. 224 INTERCHANGE.
4. PLACE RPMS ALONG EDGE LINES AND LANE LINES ALONG I.R. 77/S.R. 8 IN THE SB/NB DIRECTION FROM THE CARROLL/BUCHTEL INTERCHANGE TO THE I.R. 277/U.S. 224 INTERCHANGE, INCLUDING ALL RAMP.

LEGEND:

- | | |
|-------------------------------------|-----------------------------------|
| (ELW) PROPOSED EDGE LINE, WHITE | (XW) PROPOSED CROSSWALK LINE |
| (ELY) PROPOSED EDGE LINE, YELLOW | (A) PROPOSED LANE ARROW |
| (LL) PROPOSED LANE LINE | (W) PROPOSED WORD ON PAVEMENT |
| (CH) PROPOSED CHANNELIZING LINE | (DL) PROPOSED DOTTED LINE |
| (SL) PROPOSED STOP LINE | (TR) PROPOSED TRAVERSE MARKINGS |
| (ELY) PROPOSED EDGE LINE, 8" YELLOW | (LL) PROPOSED LANE LINE, 8" WHITE |
| (ELW) PROPOSED EDGE LINE, 8" WHITE | |

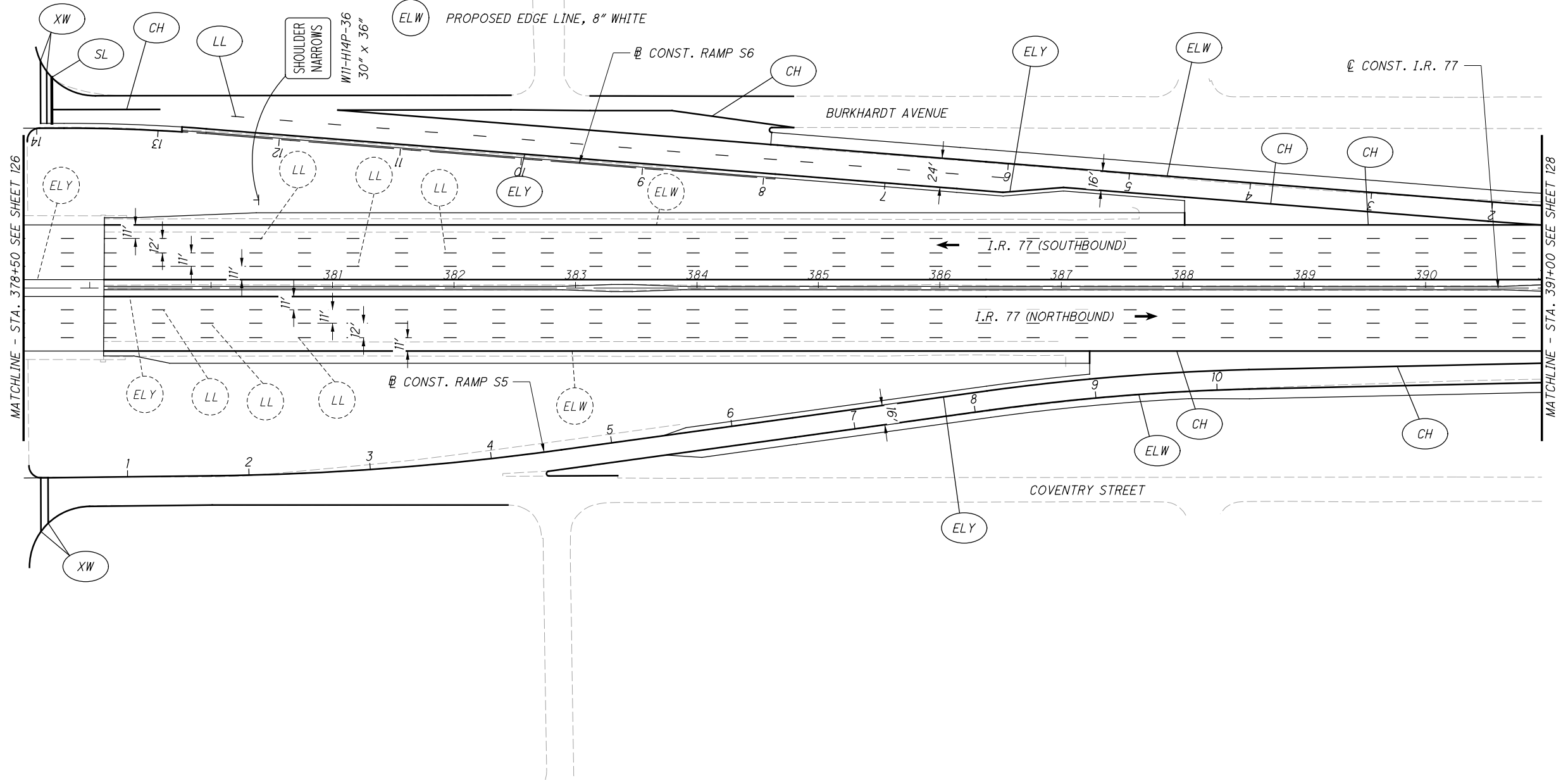





 HORIZONTAL SCALE IN FEET

CALCULATED: MLL
 CHECKED: JTJ

TRAFFIC CONTROL PLAN - I.R. 77
STA. 378+50 TO STA. 391+00

SUM-76 / 77 / 8-
 8.24 / 9.74 / 0.00

P:\02329_SUM-76_77\Design\Traffic\Sheets\02329_IP206.dgn 07/24/20 11:34:16 AM mlufes

NOTES:

1. PAVEMENT MARKINGS ARE WHOLLY THE RESPONSIBILITY OF THE DESIGN BUILD TEAM AND ARE SHOWN HERE FOR REFERENCE ONLY.
2. FOR GEOMETRIC INFORMATION, SEE SHEETS 8 TO 15.
3. PLACE BARRIER REFLECTORS ALONG THE MEDIAN BARRIER ALONG I.R. 77/S.R. 8 IN THE SB/NB DIRECTION FROM THE CARROLL/BUCHTEL INTERCHANGE TO THE I.R. 277/U.S. 224 INTERCHANGE.
4. PLACE RPMS ALONG EDGE LINES AND LANE LINES ALONG I.R. 77/S.R. 8 IN THE SB/NB DIRECTION FROM THE CARROLL/BUCHTEL INTERCHANGE TO THE I.R. 277/U.S. 224 INTERCHANGE, INCLUDING ALL RAMP.

LEGEND:

- | | |
|-------------------------------------|---------------------------------|
| (ELW) PROPOSED EDGE LINE, WHITE | (XW) PROPOSED CROSSWALK LINE |
| (ELY) PROPOSED EDGE LINE, YELLOW | (A) PROPOSED LANE ARROW |
| (LL) PROPOSED LANE LINE | (W) PROPOSED WORD ON PAVEMENT |
| (CH) PROPOSED CHANNELIZING LINE | (DL) PROPOSED DOTTED LINE |
| (SL) PROPOSED STOP LINE | (TR) PROPOSED TRAVERSE MARKINGS |
| (ELY) PROPOSED EDGE LINE, 8" YELLOW | |
| (ELW) PROPOSED EDGE LINE, 8" WHITE | |
| (LL) PROPOSED LANE LINE, 8" WHITE | |

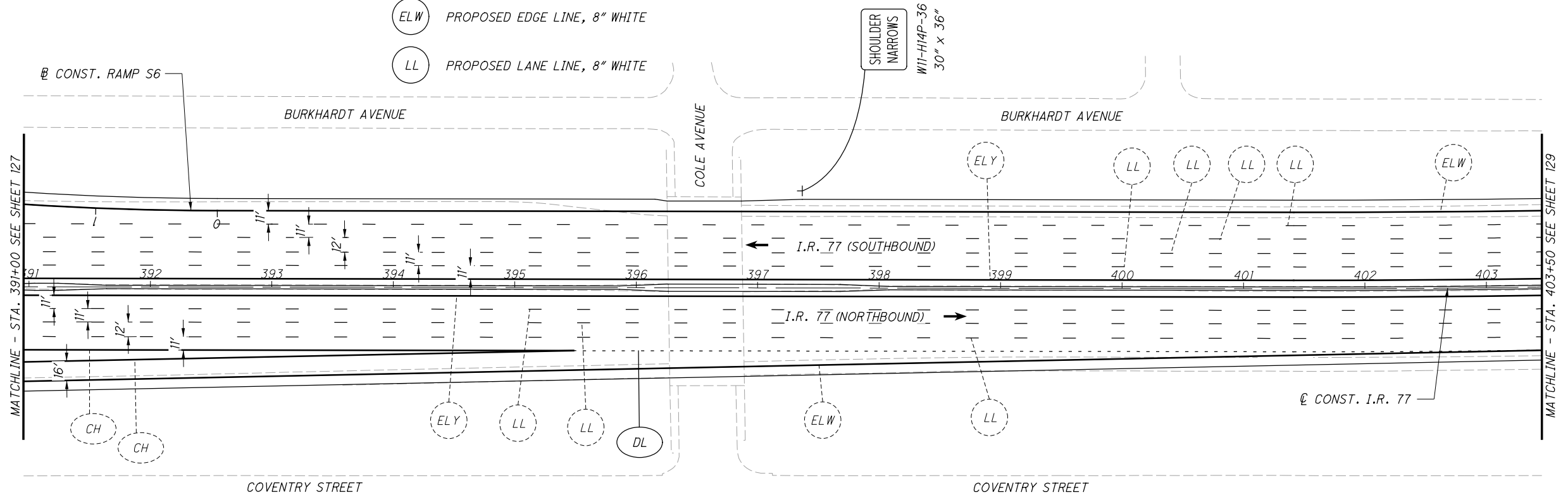

CALCULATED
M.L.L.
CHECKED
J.T.W.

0 50 100
25
HORIZONTAL
SCALE IN FEET

TRAFFIC CONTROL PLAN - I.R. 77
STA. 391+00 TO STA. 403+50

SUM-76 / 77 / 8-
8.24 / 9.74 / 0.00

NOTES:

1. PAVEMENT MARKINGS ARE WHOLLY THE RESPONSIBILITY OF THE DESIGN BUILD TEAM AND ARE SHOWN HERE FOR REFERENCE ONLY.
2. FOR GEOMETRIC INFORMATION, SEE SHEETS 8 TO 15.
3. PLACE BARRIER REFLECTORS ALONG THE MEDIAN BARRIER ALONG I.R. 77/S.R. 8 IN THE SB/NB DIRECTION FROM THE CARROLL/BUCHTEL INTERCHANGE TO THE I.R. 277/U.S. 224 INTERCHANGE.
4. PLACE RPMS ALONG EDGE LINES AND LANE LINES ALONG I.R. 77/S.R. 8 IN THE SB/NB DIRECTION FROM THE CARROLL/BUCHTEL INTERCHANGE TO THE I.R. 277/U.S. 224 INTERCHANGE, INCLUDING ALL RAMP.
5. FOR DETAILS REGARDING THE SUM-76/77/8-10.99/11.54/0.00 PROJECT SEE ATTACHMENT C.

LEGEND:

- (ELW) PROPOSED EDGE LINE, WHITE
- (ELY) PROPOSED EDGE LINE, YELLOW
- (LL) PROPOSED LANE LINE
- (CH) PROPOSED CHANNELIZING LINE
- (SL) PROPOSED STOP LINE
- (ELY) PROPOSED EDGE LINE, 8" YELLOW
- (ELW) PROPOSED EDGE LINE, 8" WHITE
- (LL) PROPOSED LANE LINE, 8" WHITE
- (XW) PROPOSED CROSSWALK LINE
- (A) PROPOSED LANE ARROW
- (W) PROPOSED WORD ON PAVEMENT
- (DL) PROPOSED DOTTED LINE
- (TR) PROPOSED TRAVERSE MARKINGS

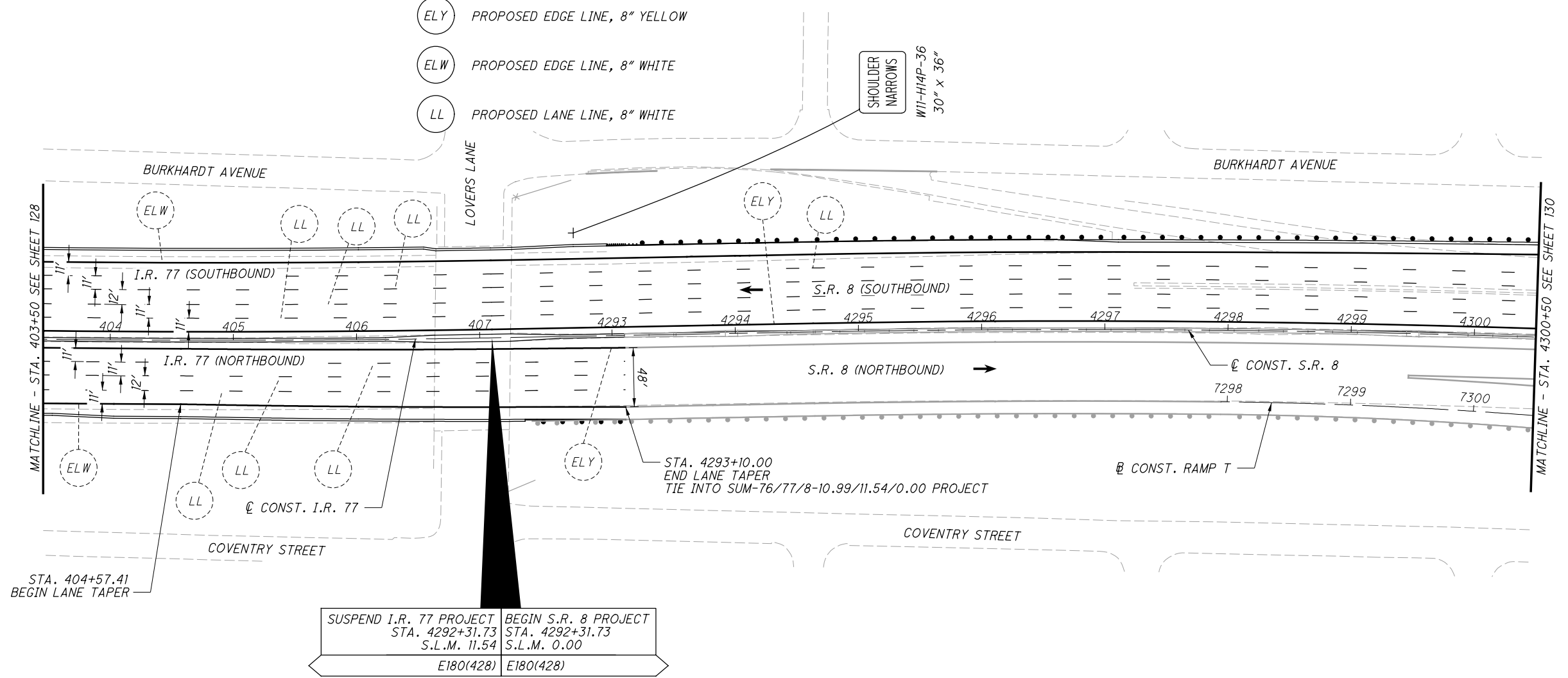

CALCULATED
MILL
CHECKED
JTW

0 50 100
25
HORIZONTAL
SCALE IN FEET

TRAFFIC CONTROL PLAN - I.R. 77 / S.R. 8
STA. 403+50 TO STA. 4300+50

SUM-76 / 77 / 8-
8.24 / 9.74 / 0.00

P:\102329_SUM-76_77\Design\Traffic\Sheets\102329_TP208.dgn 10/21/2020 11:34:30 AM mlutes

NOTES:

1. PAVEMENT MARKINGS ARE WHOLLY THE RESPONSIBILITY OF THE DESIGN BUILD TEAM AND ARE SHOWN HERE FOR REFERENCE ONLY.
2. FOR GEOMETRIC INFORMATION, SEE SHEETS 8 TO 15.
3. PLACE BARRIER REFLECTORS ALONG THE MEDIAN BARRIER ALONG I.R. 77/S.R. 8 IN THE SB/NB DIRECTION FROM THE CARROLL/BUCHTEL INTERCHANGE TO THE I.R. 277/U.S. 224 INTERCHANGE.
4. PLACE RPMS ALONG EDGE LINES AND LANE LINES ALONG I.R. 77/S.R. 8 IN THE SB/NB DIRECTION FROM THE CARROLL/BUCHTEL INTERCHANGE TO THE I.R. 277/U.S. 224 INTERCHANGE, INCLUDING ALL RAMPS.
5. FOR DETAILS REGARDING THE SUM-76/77/8-10.99/11.54/0.00 PROJECT SEE ATTACHMENT C.

LEGEND:

- | | |
|-------------------------------------|-----------------------------------|
| (ELW) PROPOSED EDGE LINE, WHITE | (XW) PROPOSED CROSSWALK LINE |
| (ELY) PROPOSED EDGE LINE, YELLOW | (A) PROPOSED LANE ARROW |
| (LL) PROPOSED LANE LINE | (W) PROPOSED WORD ON PAVEMENT |
| (CH) PROPOSED CHANNELIZING LINE | (DL) PROPOSED DOTTED LINE |
| (SL) PROPOSED STOP LINE | (TR) PROPOSED TRAVERSE MARKINGS |
| (ELY) PROPOSED EDGE LINE, 8" YELLOW | (LL) PROPOSED LANE LINE, 8" WHITE |
| (ELW) PROPOSED EDGE LINE, 8" WHITE | |

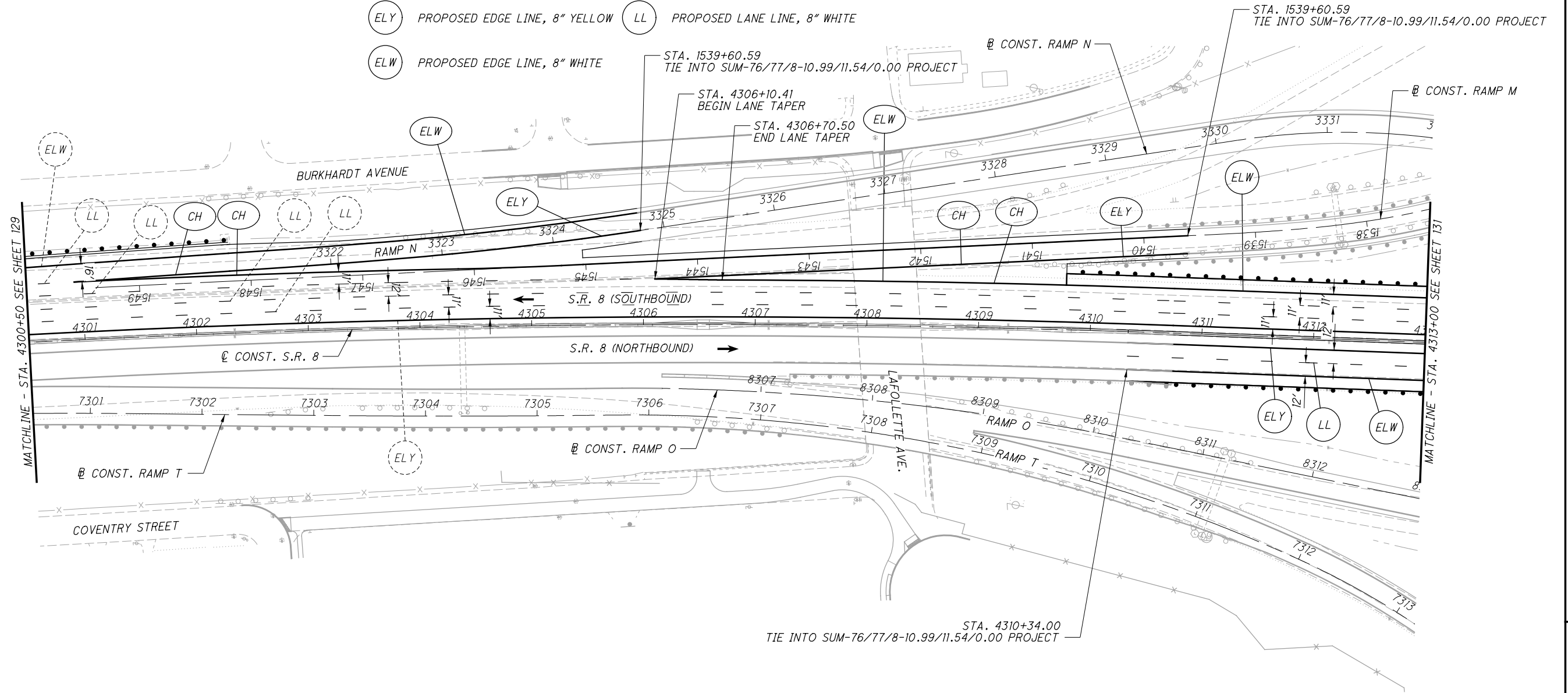

CALCULATED
M.L.L.
CHECKED
J.T.W.

0 50 100
HORIZONTAL
SCALE IN FEET

TRAFFIC CONTROL PLAN - S.R. 8
STA. 4300+50 TO STA. 1313+00

SUM-76/77/8-
8.24/9.74/0.00

NOTES:

1. PAVEMENT MARKINGS ARE WHOLLY THE RESPONSIBILITY OF THE DESIGN BUILD TEAM AND ARE SHOWN HERE FOR REFERENCE ONLY.
2. FOR GEOMETRIC INFORMATION, SEE SHEETS 8 TO 15.
3. PLACE BARRIER REFLECTORS ALONG THE MEDIAN BARRIER ALONG I.R. 77/S.R. 8 IN THE SB/NB DIRECTION FROM THE CARROLL/BUCHTEL INTERCHANGE TO THE I.R. 277/U.S. 224 INTERCHANGE.
4. PLACE RPMS ALONG EDGE LINES AND LANE LINES ALONG I.R. 77/S.R. 8 IN THE SB/NB DIRECTION FROM THE CARROLL/BUCHTEL INTERCHANGE TO THE I.R. 277/U.S. 224 INTERCHANGE, INCLUDING ALL RAMP.
5. FOR DETAILS REGARDING THE SUM-76/77/8-10.99/11.54/0.00 PROJECT SEE ATTACHMENT C.

LEGEND:

- | | |
|-------------------------------------|---------------------------------|
| (ELW) PROPOSED EDGE LINE, WHITE | (XW) PROPOSED CROSSWALK LINE |
| (ELY) PROPOSED EDGE LINE, YELLOW | (A) PROPOSED LANE ARROW |
| (LL) PROPOSED LANE LINE | (W) PROPOSED WORD ON PAVEMENT |
| (CH) PROPOSED CHANNELIZING LINE | (DL) PROPOSED DOTTED LINE |
| (SL) PROPOSED STOP LINE | (TR) PROPOSED TRAVERSE MARKINGS |
| (ELY) PROPOSED EDGE LINE, 8" YELLOW | |
| (ELW) PROPOSED EDGE LINE, 8" WHITE | |
| (LL) PROPOSED LANE LINE, 8" WHITE | |

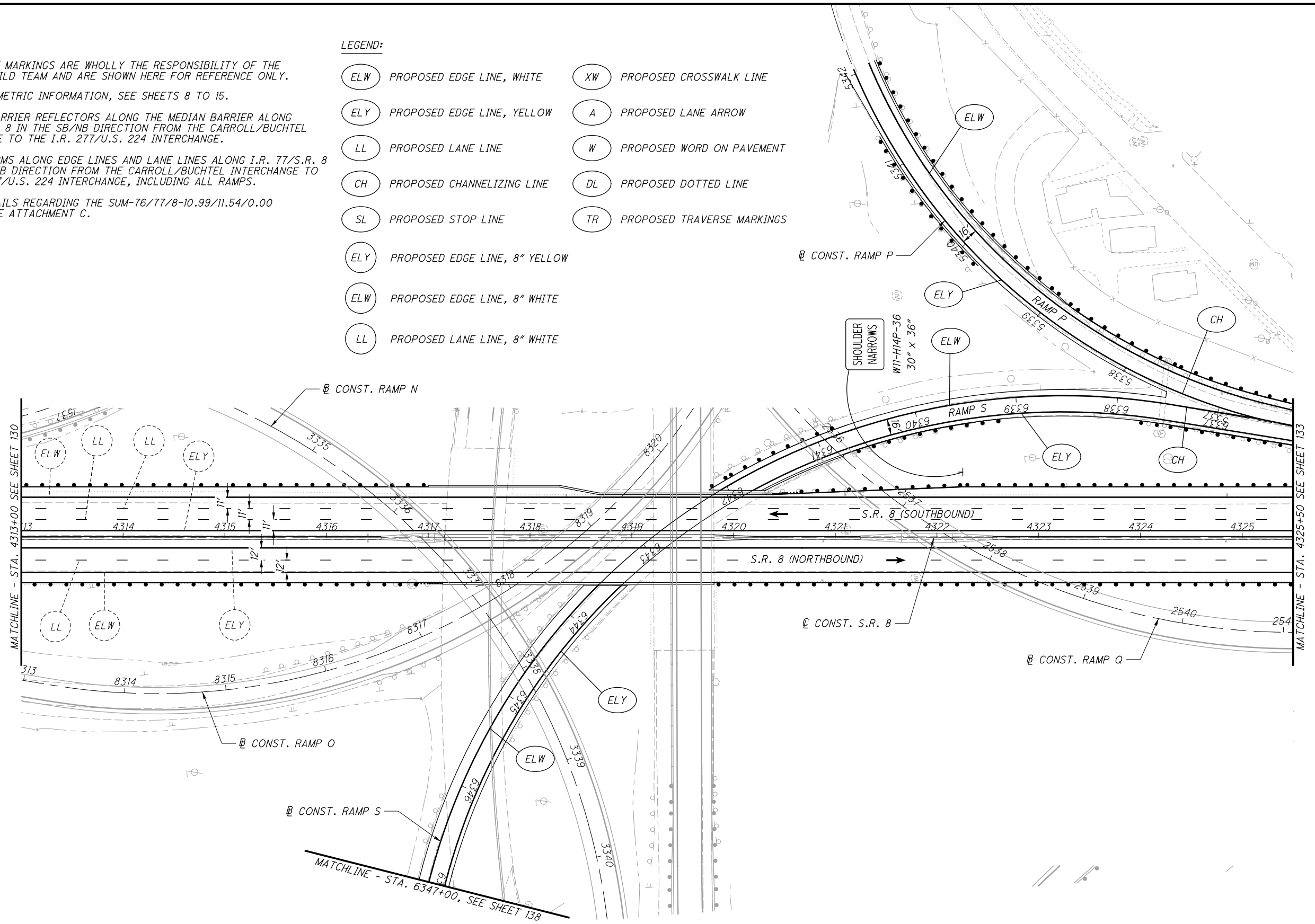

CALCULATED
MILL
CHECKED
JTW

0 50 100
25
HORIZONTAL
SCALE IN FEET

TRAFFIC CONTROL PLAN - S.R. 8
STA. 4313+00 TO STA. 4325+50

SUM-76/77/8-
8.24/9.74/0.00

NOTES:

1. PAVEMENT MARKINGS ARE WHOLLY THE RESPONSIBILITY OF THE DESIGN BUILD TEAM AND ARE SHOWN HERE FOR REFERENCE ONLY.
2. FOR GEOMETRIC INFORMATION, SEE SHEETS 8 TO 15.
3. PLACE BARRIER REFLECTORS ALONG THE MEDIAN BARRIER ALONG I.R. 77/S.R. 8 IN THE SB/NB DIRECTION FROM THE CARROLL/BUCHTEL INTERCHANGE TO THE I.R. 277/U.S. 224 INTERCHANGE.
4. PLACE RPMS ALONG EDGE LINES AND LANE LINES ALONG I.R. 77/S.R. 8 IN THE SB/NB DIRECTION FROM THE CARROLL/BUCHTEL INTERCHANGE TO THE I.R. 277/U.S. 224 INTERCHANGE, INCLUDING ALL RAMP.
5. FOR DETAILS REGARDING THE SUM-76/77/8-10.99/11.54/0.00 PROJECT SEE ATTACHMENT C.

LEGEND:

- | | |
|-------------------------------------|---------------------------------|
| (ELW) PROPOSED EDGE LINE, WHITE | (XW) PROPOSED CROSSWALK LINE |
| (ELY) PROPOSED EDGE LINE, YELLOW | (A) PROPOSED LANE ARROW |
| (LL) PROPOSED LANE LINE | (W) PROPOSED WORD ON PAVEMENT |
| (CH) PROPOSED CHANNELIZING LINE | (DL) PROPOSED DOTTED LINE |
| (SL) PROPOSED STOP LINE | (TR) PROPOSED TRAVERSE MARKINGS |
| (ELY) PROPOSED EDGE LINE, 8" YELLOW | |
| (ELW) PROPOSED EDGE LINE, 8" WHITE | |
| (LL) PROPOSED LANE LINE, 8" WHITE | |

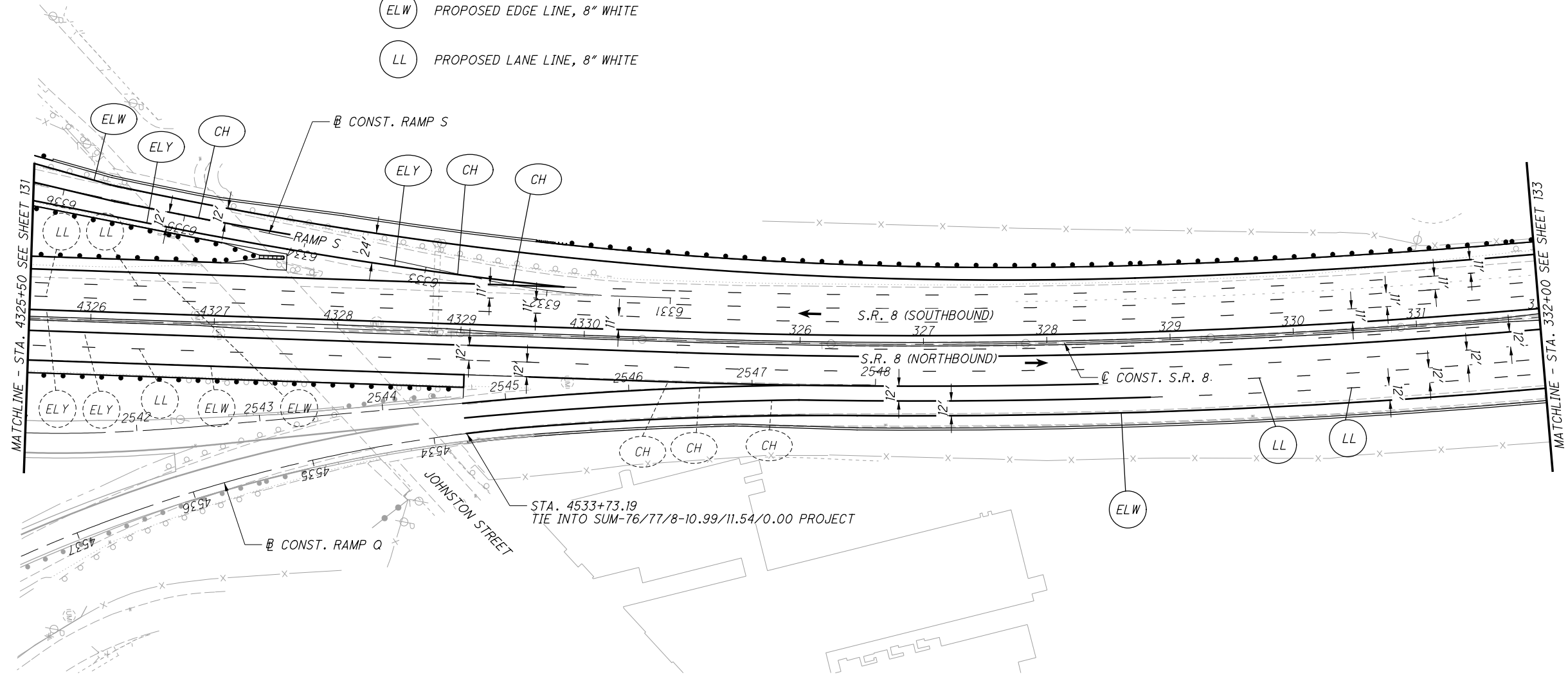

CALCULATED MLL
CHECKED JTJ

0 50 100
25
HORIZONTAL SCALE IN FEET

TRAFFIC CONTROL PLAN - S.R. 8
STA. 4325+50 TO STA. 332+00

SUM-76/77/8-
8.24/9.74/0.00

NOTES:

1. PAVEMENT MARKINGS ARE WHOLLY THE RESPONSIBILITY OF THE DESIGN BUILD TEAM AND ARE SHOWN HERE FOR REFERENCE ONLY.
2. FOR GEOMETRIC INFORMATION, SEE SHEETS 8 TO 15.
3. PLACE BARRIER REFLECTORS ALONG THE MEDIAN BARRIER ALONG I.R. 77/S.R. 8 IN THE SB/NB DIRECTION FROM THE CARROLL/BUCHTEL INTERCHANGE TO THE I.R. 277/U.S. 224 INTERCHANGE.
4. PLACE RPMS ALONG EDGE LINES AND LANE LINES ALONG I.R. 77/S.R. 8 IN THE SB/NB DIRECTION FROM THE CARROLL/BUCHTEL INTERCHANGE TO THE I.R. 277/U.S. 224 INTERCHANGE, INCLUDING ALL RAMP.

LEGEND:

- | | |
|-------------------------------------|-----------------------------------|
| (ELW) PROPOSED EDGE LINE, WHITE | (XW) PROPOSED CROSSWALK LINE |
| (ELY) PROPOSED EDGE LINE, YELLOW | (A) PROPOSED LANE ARROW |
| (LL) PROPOSED LANE LINE | (W) PROPOSED WORD ON PAVEMENT |
| (CH) PROPOSED CHANNELIZING LINE | (DL) PROPOSED DOTTED LINE |
| (SL) PROPOSED STOP LINE | (TR) PROPOSED TRAVERSE MARKINGS |
| (ELY) PROPOSED EDGE LINE, 8" YELLOW | (LL) PROPOSED LANE LINE, 8" WHITE |
| (ELW) PROPOSED EDGE LINE, 8" WHITE | |

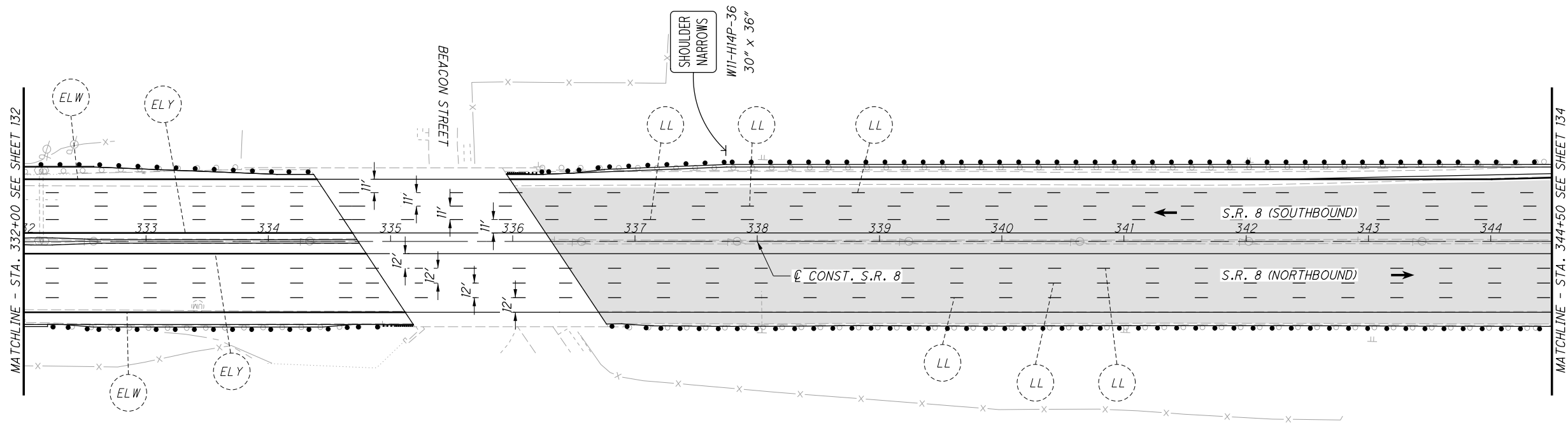

CALCULATED
M.L.L.
CHECKED
J.T.W.

0 50 100
25
HORIZONTAL
SCALE IN FEET

N

TRAFFIC CONTROL PLAN - S.R. 8
STA. 332+00 TO STA. 344+50

SUM-76 / 77 / 8-
8.24 / 9.74 / 0.00

NOTES:

1. PAVEMENT MARKINGS ARE WHOLLY THE RESPONSIBILITY OF THE DESIGN BUILD TEAM AND ARE SHOWN HERE FOR REFERENCE ONLY.

2. FOR GEOMETRIC INFORMATION, SEE SHEETS 8 TO 15.

3. PLACE BARRIER REFLECTORS ALONG THE MEDIAN BARRIER ALONG I.R. 77/S.R. 8 IN THE SB/NB DIRECTION FROM THE CARROLL/BUCHTEL INTERCHANGE TO THE I.R. 277/U.S. 224 INTERCHANGE.

4. PLACE RPMS ALONG EDGE LINES AND LANE LINES ALONG I.R. 77/S.R. 8 IN THE SB/NB DIRECTION FROM THE CARROLL/BUCHTEL INTERCHANGE TO THE I.R. 277/U.S. 224 INTERCHANGE, INCLUDING ALL RAMP.

LEGEND:

- | | |
|-------------------------------------|---------------------------------|
| (ELW) PROPOSED EDGE LINE, WHITE | (XW) PROPOSED CROSSWALK LINE |
| (ELY) PROPOSED EDGE LINE, YELLOW | (A) PROPOSED LANE ARROW |
| (LL) PROPOSED LANE LINE | (W) PROPOSED WORD ON PAVEMENT |
| (CH) PROPOSED CHANNELIZING LINE | (DL) PROPOSED DOTTED LINE |
| (SL) PROPOSED STOP LINE | (TR) PROPOSED TRAVERSE MARKINGS |
| (ELY) PROPOSED EDGE LINE, 8" YELLOW | |
| (ELW) PROPOSED EDGE LINE, 8" WHITE | |
| (LL) PROPOSED LANE LINE, 8" WHITE | |

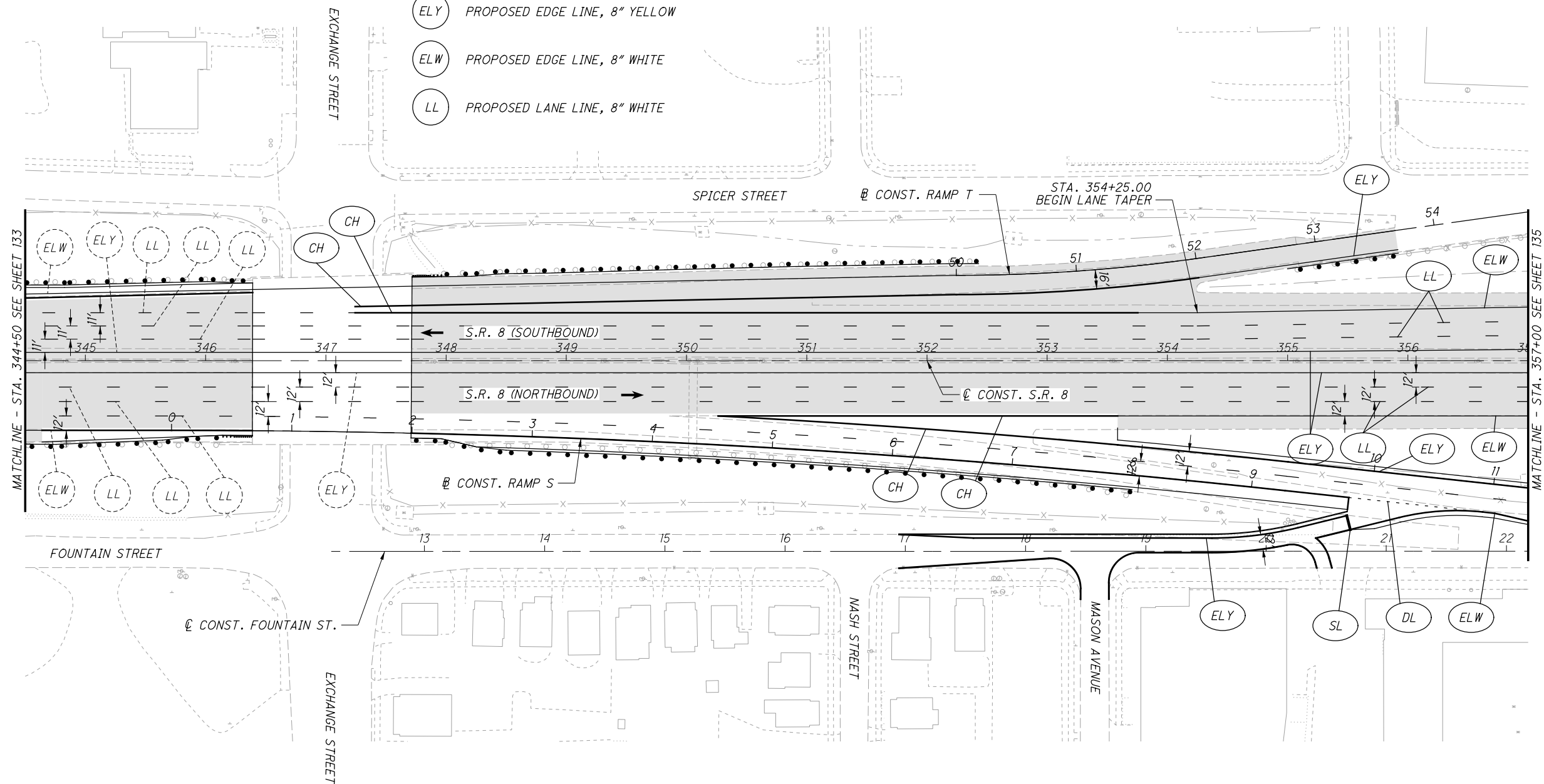





 HORIZONTAL SCALE IN FEET

TRAFFIC CONTROL PLAN - S.R. 8
STA. 344+50 TO STA. 357+00

SUM-76/77/8-
8.24/9.74/0.00

P:\02329_SUM-76_77\Design\Traffic\Sheets\02329_TP213.dgn Sheet 8/7/2020 11:34:51AM mlutes

NOTES:

1. PAVEMENT MARKINGS ARE WHOLLY THE RESPONSIBILITY OF THE DESIGN BUILD TEAM AND ARE SHOWN HERE FOR REFERENCE ONLY.
2. FOR GEOMETRIC INFORMATION, SEE SHEETS 8 TO 15.
3. PLACE BARRIER REFLECTORS ALONG THE MEDIAN BARRIER ALONG I.R. 77/S.R. 8 IN THE SB/NB DIRECTION FROM THE CARROLL/BUCHTEL INTERCHANGE TO THE I.R. 277/U.S. 224 INTERCHANGE.
4. PLACE RPMS ALONG EDGE LINES AND LANE LINES ALONG I.R. 77/S.R. 8 IN THE SB/NB DIRECTION FROM THE CARROLL/BUCHTEL INTERCHANGE TO THE I.R. 277/U.S. 224 INTERCHANGE, INCLUDING ALL RAMP.

LEGEND:

- | | |
|-------------------------------------|---------------------------------|
| (ELW) PROPOSED EDGE LINE, WHITE | (XW) PROPOSED CROSSWALK LINE |
| (ELY) PROPOSED EDGE LINE, YELLOW | (A) PROPOSED LANE ARROW |
| (LL) PROPOSED LANE LINE | (W) PROPOSED WORD ON PAVEMENT |
| (CH) PROPOSED CHANNELIZING LINE | (DL) PROPOSED DOTTED LINE |
| (SL) PROPOSED STOP LINE | (TR) PROPOSED TRAVERSE MARKINGS |
| (ELY) PROPOSED EDGE LINE, 8" YELLOW | |
| (ELW) PROPOSED EDGE LINE, 8" WHITE | |
| (LL) PROPOSED LANE LINE, 8" WHITE | |

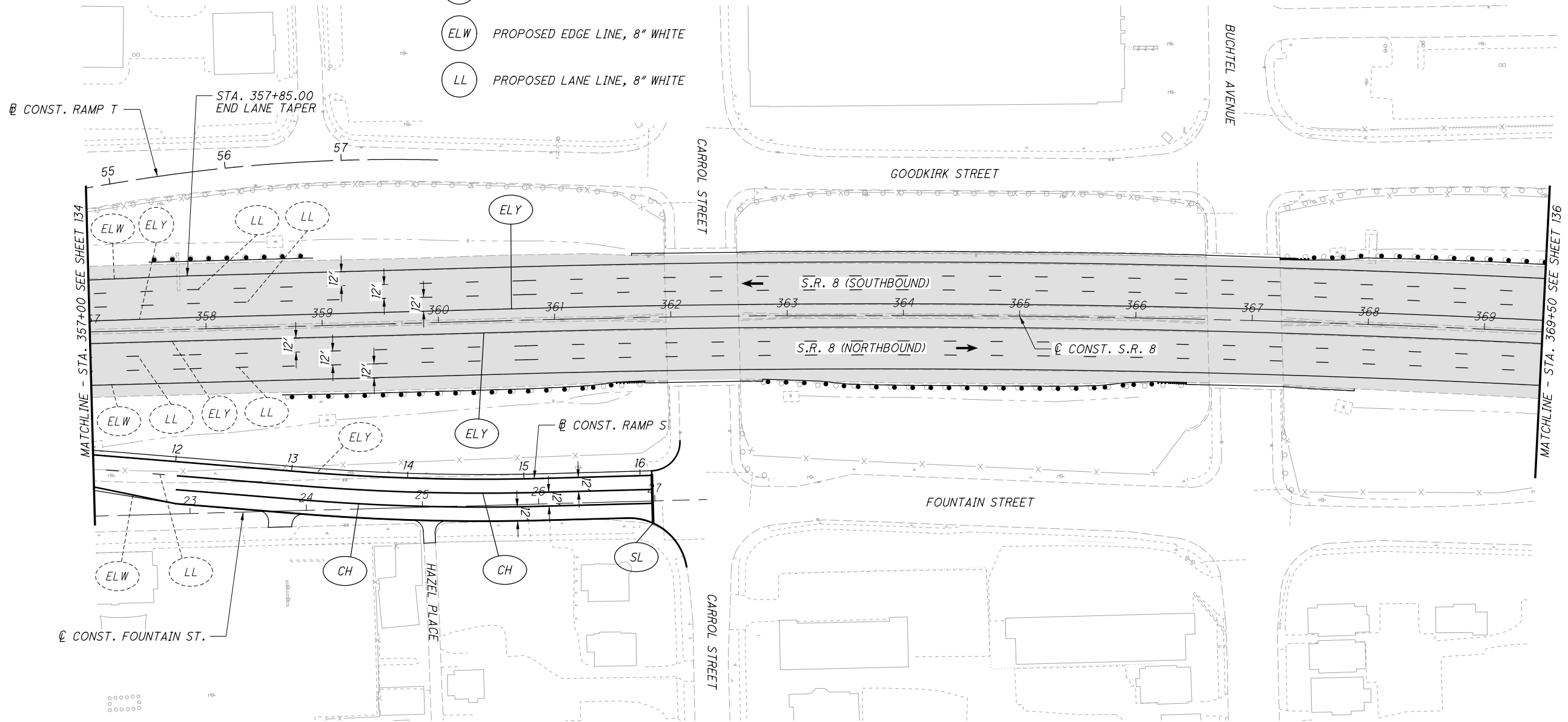

CALCULATED
M.L.L.
CHECKED
J.T.W.

0 50 100
HORIZONTAL
SCALE IN FEET

TRAFFIC CONTROL PLAN - S.R. 8
STA. 357+00 TO STA. 369+50

SUM-76/77/8-
8.24/9.74/0.00

NOTES:

1. PAVEMENT MARKINGS ARE WHOLLY THE RESPONSIBILITY OF THE DESIGN BUILD TEAM AND ARE SHOWN HERE FOR REFERENCE ONLY.
2. FOR GEOMETRIC INFORMATION, SEE SHEETS 8 TO 15.
3. PLACE BARRIER REFLECTORS ALONG THE MEDIAN BARRIER ALONG I.R. 77/S.R. 8 IN THE SB/NB DIRECTION FROM THE CARROLL/BUCHTEL INTERCHANGE TO THE I.R. 277/U.S. 224 INTERCHANGE.
4. PLACE RPMS ALONG EDGE LINES AND LANE LINES ALONG I.R. 77/S.R. 8 IN THE SB/NB DIRECTION FROM THE CARROLL/BUCHTEL INTERCHANGE TO THE I.R. 277/U.S. 224 INTERCHANGE, INCLUDING ALL RAMP.

LEGEND:

- | | |
|-------------------------------------|-----------------------------------|
| (ELW) PROPOSED EDGE LINE, WHITE | (XW) PROPOSED CROSSWALK LINE |
| (ELY) PROPOSED EDGE LINE, YELLOW | (A) PROPOSED LANE ARROW |
| (LL) PROPOSED LANE LINE | (W) PROPOSED WORD ON PAVEMENT |
| (CH) PROPOSED CHANNELIZING LINE | (DL) PROPOSED DOTTED LINE |
| (SL) PROPOSED STOP LINE | (TR) PROPOSED TRAVERSE MARKINGS |
| (ELY) PROPOSED EDGE LINE, 8" YELLOW | (LL) PROPOSED LANE LINE, 8" WHITE |
| (ELW) PROPOSED EDGE LINE, 8" WHITE | |

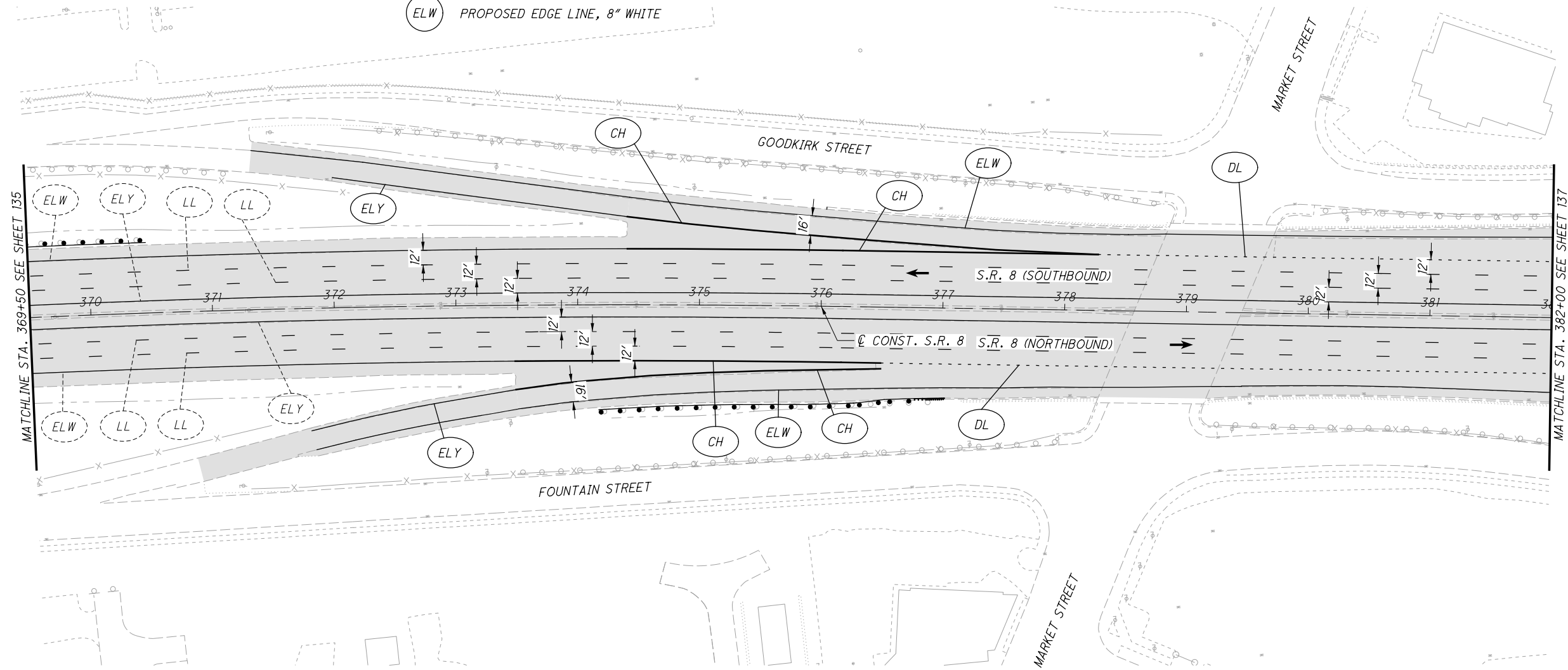

CALCULATED
MILL
CHECKED
JTJW

0 50 100
25
HORIZONTAL
SCALE IN FEET

TRAFFIC CONTROL PLAN - S.R. 8
STA. 369+50 TO STA. 382+00

SUM-76/77/8-
8.24/9.74/0.00

NOTES:

1. PAVEMENT MARKINGS ARE WHOLLY THE RESPONSIBILITY OF THE DESIGN BUILD TEAM AND ARE SHOWN HERE FOR REFERENCE ONLY.
2. FOR GEOMETRIC INFORMATION, SEE SHEETS 8 TO 15.
3. PLACE BARRIER REFLECTORS ALONG THE MEDIAN BARRIER ALONG I.R. 77/S.R. 8 IN THE SB/NB DIRECTION FROM THE CARROLL/BUCHTEL INTERCHANGE TO THE I.R. 277/U.S. 224 INTERCHANGE.
4. PLACE RPMS ALONG EDGE LINES AND LANE LINES ALONG I.R. 77/S.R. 8 IN THE SB/NB DIRECTION FROM THE CARROLL/BUCHTEL INTERCHANGE TO THE I.R. 277/U.S. 224 INTERCHANGE, INCLUDING ALL RAMPS.

LEGEND:

- | | |
|-------------------------------------|---------------------------------|
| (ELW) PROPOSED EDGE LINE, WHITE | (XW) PROPOSED CROSSWALK LINE |
| (ELY) PROPOSED EDGE LINE, YELLOW | (A) PROPOSED LANE ARROW |
| (LL) PROPOSED LANE LINE | (W) PROPOSED WORD ON PAVEMENT |
| (CH) PROPOSED CHANNELIZING LINE | (DL) PROPOSED DOTTED LINE |
| (SL) PROPOSED STOP LINE | (TR) PROPOSED TRAVERSE MARKINGS |
| (ELY) PROPOSED EDGE LINE, 8" YELLOW | |
| (ELW) PROPOSED EDGE LINE, 8" WHITE | |
| (LL) PROPOSED LANE LINE, 8" WHITE | |

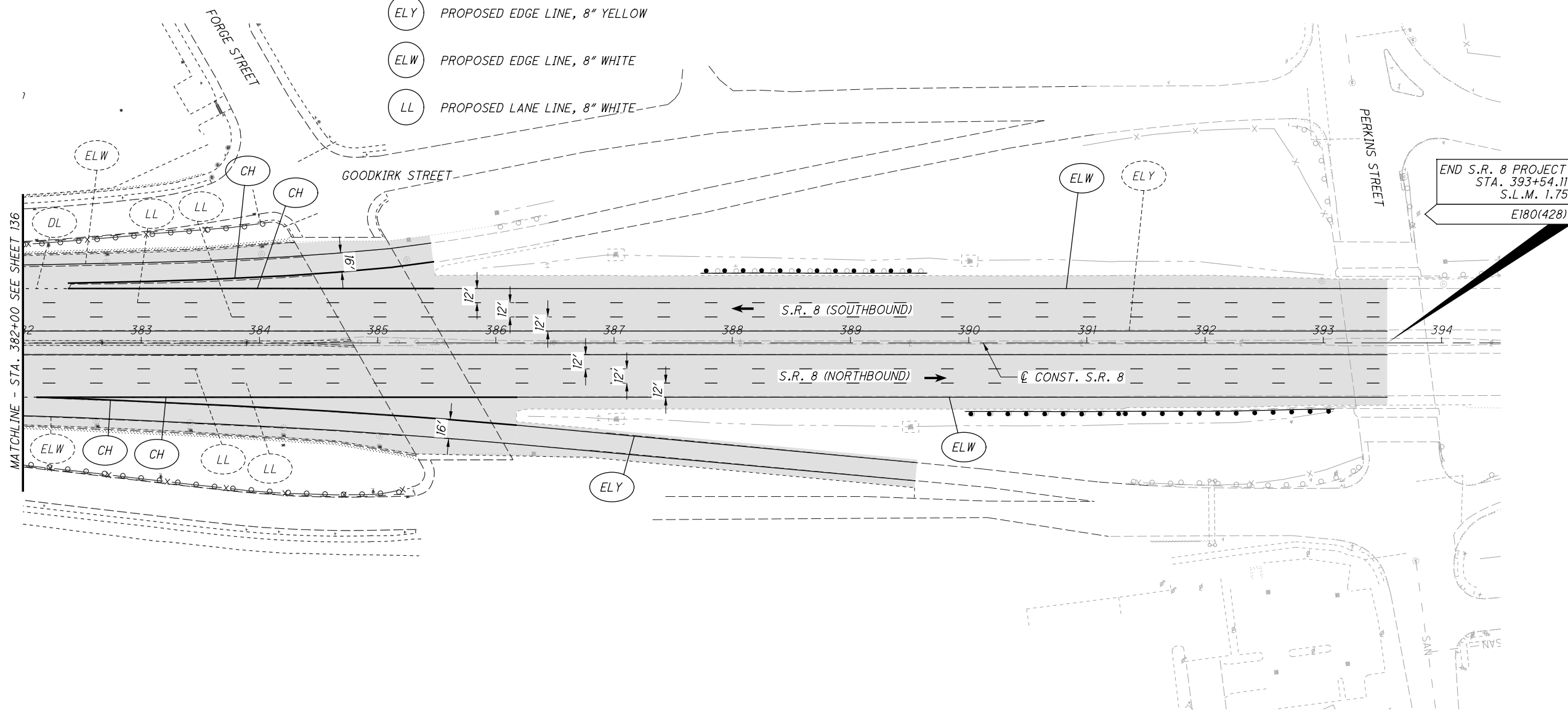

CALCULATED
M.L.L.
CHECKED
J.T.W.

0 50 100
25
HORIZONTAL
SCALE IN FEET

TRAFFIC CONTROL PLAN - S.R. 8
STA. 382+00 TO END S.R. 8 PROJECT

SUM-76/77/8-
8.24/9.74/0.00

NOTES:

1. PAVEMENT MARKINGS ARE WHOLLY THE RESPONSIBILITY OF THE DESIGN BUILD TEAM AND ARE SHOWN HERE FOR REFERENCE ONLY.
2. FOR GEOMETRIC INFORMATION, SEE SHEETS 8 TO 15.
3. PLACE BARRIER REFLECTORS ALONG THE MEDIAN BARRIER ALONG I.R. 77/S.R. 8 IN THE SB/NB DIRECTION FROM THE CARROLL/BUCHTEL INTERCHANGE TO THE I.R. 277/U.S. 224 INTERCHANGE.
4. PLACE RPMS ALONG EDGE LINES AND LANE LINES ALONG I.R. 77/S.R. 8 IN THE SB/NB DIRECTION FROM THE CARROLL/BUCHTEL INTERCHANGE TO THE I.R. 277/U.S. 224 INTERCHANGE, INCLUDING ALL RAMPS.

LEGEND:

- | | |
|-------------------------------------|-----------------------------------|
| (ELW) PROPOSED EDGE LINE, WHITE | (XW) PROPOSED CROSSWALK LINE |
| (ELY) PROPOSED EDGE LINE, YELLOW | (A) PROPOSED LANE ARROW |
| (LL) PROPOSED LANE LINE | (W) PROPOSED WORD ON PAVEMENT |
| (CH) PROPOSED CHANNELIZING LINE | (DL) PROPOSED DOTTED LINE |
| (SL) PROPOSED STOP LINE | (TR) PROPOSED TRAVERSE MARKINGS |
| (ELY) PROPOSED EDGE LINE, 8" YELLOW | (LL) PROPOSED LANE LINE, 8" WHITE |
| (ELW) PROPOSED EDGE LINE, 8" WHITE | |

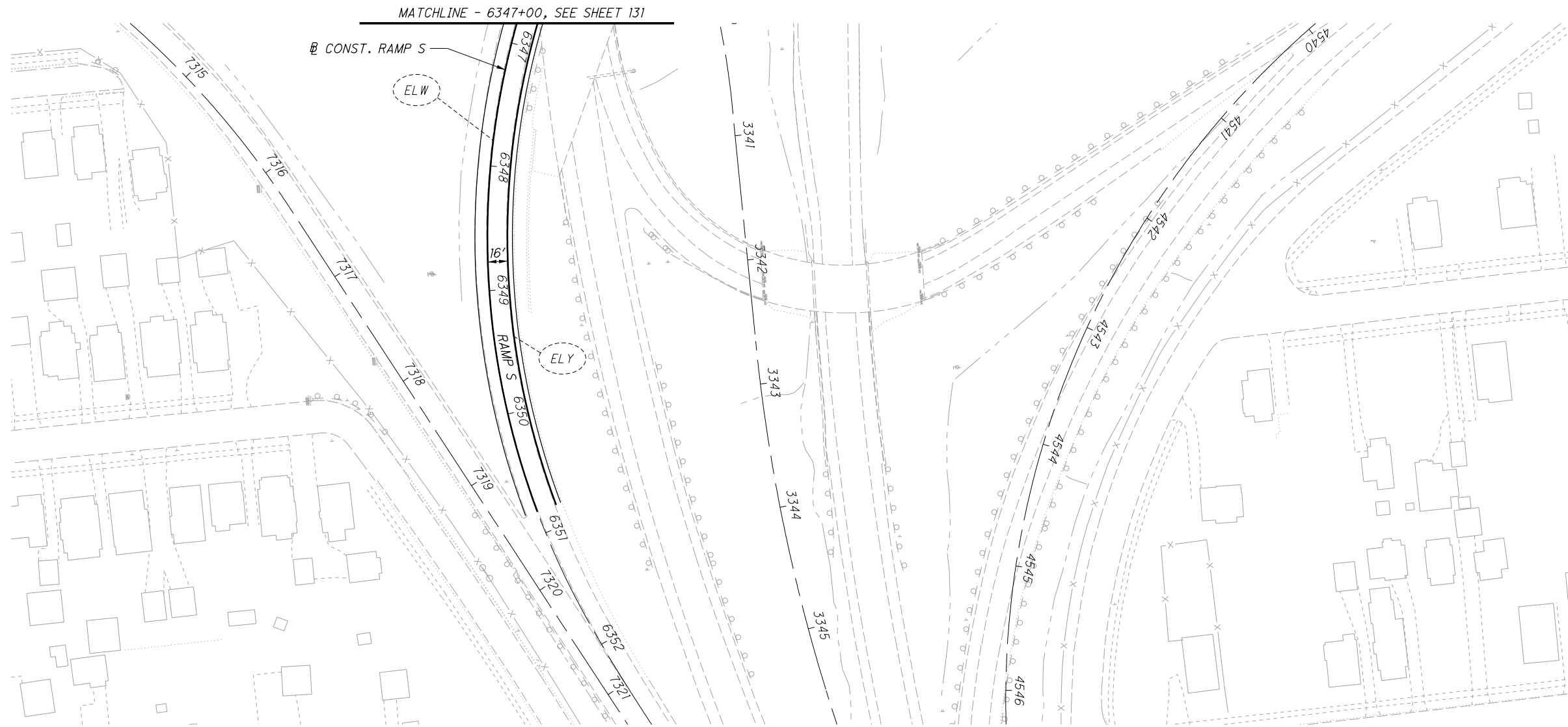

CALCULATED
MILL
CHECKED
JTW

0 50 100
HORIZONTAL
SCALE IN FEET

TRAFFIC CONTROL PLAN - RAMP S
STA. 6347+00 TO END WORK

SUM-76 77 8-
8.24 / 9.74 / 0.00