**DRAFT REPORT
STRUCTURE FOUNDATION EXPLORATION REPORT
GRE-68-12.65
GREENE COUNTY, OHIO
PID#: 115388**

Prepared For:

Carpenter Marty Transportation
6612 Singletree Drive
Columbus, OH 43229

Prepared by:

NATIONAL ENGINEERING AND ARCHITECTURAL SERVICES INC.

2800 Corporate Exchange Drive, Suite 240
Columbus, Ohio 43231

NEAS PROJECT 24-0063

February 17, 2025



REVIEW COMPLETE
PM _____
BRIDGES _____
CONSTRUCT _____
DRAINAGE _____
ENVIRON _____
GEOTECH Casey Carriere, P.E. 2/27/2025
ITS _____
MOT _____
PAVEMENT _____
ROADWAY _____
R/W _____
SURVEY _____
TRAFFIC _____
UTILITIES _____
OTHER _____
OTHER _____

SECTION 1: GEOTECHNICAL PROJECT INFORMATION

TABLE OF CONTENTS

1.1 INTRODUCTION.....	1
1.1.1. GENERAL.....	1
1.2 GEOLOGY AND OBSERVATIONS OF THE PROJECT	1
1.2.1. GEOLOGY AND PHYSIOGRAPHY	1
1.2.2. HYDROLOGY/HYDROGEOLOGY	2
1.2.3. MINING AND OIL/GAS PRODUCTION.....	2
1.2.4. HISTORICAL RECORDS AND PREVIOUS PHASES OF PROJECT EXPLORATION.....	2
1.2.5. FIELD RECONNAISSANCE	3
1.3 GEOTECHNICAL EXPLORATION.....	4
1.3.1. FIELD EXPLORATION PROGRAM.....	4
1.3.2. LABORATORY TESTING PROGRAM.....	5
1.3.2.1. <i>Classification Testing</i>	5
1.3.2.2. <i>Standard Penetration Test Results</i>	6
1.3.2.3. <i>Consolidation Testing</i>	6
1.3.2.4. <i>Streambed Grain Size Distribution</i>	6
1.4 FINDINGS, ANALYSES AND RECOMMENDATIONS	6
1.5 QUALIFICATIONS	7

LIST OF TABLES

TABLE 1:	STANTEC PROJECT BORING SUMMARY	3
TABLE 2:	PROJECT BORING SUMMARY	5
TABLE 3:	CONSOLIDATION TEST RESULTS.....	6
TABLE 4:	STREAMBED GRAIN SIZE ANALYSIS RESULTS	6

LIST OF APPENDICES

APPENDIX 1A: BORING LOCATION PLAN
APPENDIX 1B: STANTEC PREVIOUS PHASES OF PROJECT EXPLORATION LETTER
APPENDIX 1C: BORING LOGS AND LABORATORY TEST RESULTS

Structure Foundation Exploration Report

GRE-68-12.65

Greene County, Ohio

PID: 115388

1.1 INTRODUCTION

1.1.1. General

National Engineering & Architectural Services, Inc. (NEAS) presents our Structure Foundation Exploration Report for the proposed pedestrian bridge structure and associated retaining walls planned as part of the Ohio Department of Transportation (ODOT) GRE-68-12.65 (PID 115388) project located within Xenia Township, Greene County, Ohio.

It is our understanding that the proposed project is intended to provide a safe access path from the Little Miami Scenic Trail (LMST) to the newly constructed Great Council State Park and Shawnee Interpretive Center located at 1575 U.S. Route 68 (US-68), within Oldtown, Ohio. The proposed project will include the construction of a new pedestrian bridge structure to direct pedestrian and bike traffic from the LMST, west over Oldtown Creek and US-68, to the existing sidewalk located on the west side of US-68. In addition to the proposed pedestrian bridge, multiple retaining walls are planned on the west side of US-68, in the vicinity of the rear abutment of the proposed bridge. The referenced walls are required to provide grade separation between the proposed pedestrian path and the surrounding area as it descends from the bridge to the existing sidewalk grade. This report presents a summary of the encountered surficial and subsurface conditions as well as our recommendations for structure foundation design and construction. Foundation recommendations and analysis were performed in accordance with Load and Resistance Factors Design (LRFD) method as set forth in AASHTO's Publication LRFD Bridge Design Specifications, 9th Edition (AASHTO, 2020), ODOT's Bridge Design Manual 2020 Edition (BDM) (ODOT, 2024) and ODOT's July 2024 revision of their Geotechnical Design Manual (GDM) (ODOT, 2024).

The exploration was conducted in general accordance with Barr Engineering, Inc. DBA National Engineering & Architectural Services, Inc.'s (NEAS) proposal to Carpenter Marty Transportation, dated August 23, 2024, with the provisions of ODOT's *Specifications for Geotechnical Explorations* (SGE) (ODOT, 2024)

The scope of work performed by NEAS as part of the referenced project included: a review of published and previously developed geotechnical information; perform a total of 5 additional test borings; laboratory testing of soil samples in accordance with the SGE; performing geotechnical engineering analysis to assess proposed foundation design and construction considerations, and development of this summary report.

1.2 GEOLOGY AND OBSERVATIONS OF THE PROJECT

1.2.1. Geology and Physiography

The project site is located within the Southern Ohio Loamy till Plain, which is characterized as end and recessional moraines, commonly associated with boulder belts, between relatively flat-lying ground moraine, cut by steep-valleyed large streams with surface soils consisting of loamy till. Buried valleys are common and are generally filled with outwash and alternate between broad floodplains and narrows. Elevations of the region ranges from 530 to 1,150 ft above mean sea level (amsl), with moderate relief (200 ft). The geology within this region is described as loamy, high-lime Wisconsinan-age till, outwash and loess over Lower Paleozoic-age carbonate rocks (i.e., limestone or dolostone) and, in the east, shales. (ODGS, 1998).

The geology at the project site is mapped as an average of 30 ft of Wisconsinan-age sand and gravel, underlain by an average of 40 feet of Wisconsinan-age loam till, underlain by 250 ft of Wisconsinan-age

Structure Foundation Exploration Report

GRE-68-12.65

Greene County, Ohio

PID: 115388

sand and gravel, all resting atop limestone and shale. The sand and gravel is described as being intermixed and interbedded. The grains are moderately to well sorted, moderately to well rounded, finely stratified to massive, and may exhibit cross bedded. Organic materials may also be present locally. Sand and gravel found in deep buried valleys are noted as potentially being older than the Wisconsinan period. The loam till in this region contains silt, sand, and gravel lenses with high carbonate content and common joints and fractures. Thickness ranges from 20 to 30 feet, at depth comprising various till units, including clay and silt beds.

Based on the Bedrock Geologic Units Map of Ohio (USGS & ODGS, 2006), bedrock within the project area is primarily shale, dolomite, and limestone from the Cincinnati Group as used by Wickstrom (1990), an Ordovician-age formation. They are described as interbedded, various shades of gray, thin to medium bedded, and it occurs beneath glacial drift. Based on the ODNR bedrock topography map of Ohio, bedrock elevation at the project site can be expected to be between about 600 and 650 ft amsl, putting bedrock at depths ranging from 176 to 240 ft below ground surface (bgs) (ODGS, 2003).

The soils at the project site have been mapped (Web Soil Survey) by the Natural Resources Conservation Service (USDA, 2015) as Wea silt loam in the eastern portion and Eldean silt loam in the rest of the project area. Soils classified as Wea series are characterized as very deep, well drained soils, and deep or very deep to calcareous, stratified sandy and gravelly outwash. The Wea series is comprised of coarse-grained and fine-grained soils and classifies as A-1-a, A-1-b, A-2-6, A-4, A-6, and A-7-6 type soils according to the AASHTO method of soil classification. Soils in the Eldean series are characterized as very deep, well drained soils that are moderately deep to calcareous sandy and gravelly material. The Eldean series is comprised of primarily coarse-grained and fine-grained soils and classifies as A-1, A-1-a, A-2, A-2-6, A-4, A-6, and A-7-6 type soils according to the AASHTO method of soil classification.

1.2.2. Hydrology/Hydrogeology

Groundwater at the project site can be expected at an elevation consistent with that of the nearby Oldtown Creek as it is the most dominant hydraulic influence in the vicinity of the project's boundaries. The water level of the creek may be generally representative of the local groundwater table. However, it should be noted that perched groundwater systems may be existent in areas due to the presence of fine-grained soils making it difficult for groundwater to permeate to the phreatic surface.

The project site is located within a regulatory floodway as well as 1% annual chance flood hazard area based on available mapping by the Federal Emergency Management Agency's (FEMA) National Flood Hazard mapping program (FEMA, 2024).

1.2.3. Mining and Oil/Gas Production

No abandoned mines are noted on ODNR's Abandoned Underground Mine Locator within the immediate vicinity of the project's boundaries (ODNR [1], 2016).

No oil or gas wells are noted on ODNR's Ohio Oil & Gas Locator within the immediate vicinity of the project's boundaries (ODNR [2], 2016).

1.2.4. Historical Records and Previous Phases of Project Exploration

As part of the initial phases of the referenced project, ODOT contracted Stantec Consulting Services Inc. (Stantec) and subsequently UES (formerly Geotechnology) to conduct an initial exploration of the project area. The initial exploration for this project was conducted by UES between January 2 and January 4, 2024 and included 4 borings each drilled to a depth of 51.5 ft below ground surface (bgs). The pertinent

Structure Foundation Exploration Report
GRE-68-12.65
Greene County, Ohio
PID: 115388

information regarding the subsurface investigation can be found in the document titled "Geotechnical Exploration Logs, GRE-68-12.65, PID 115388, Green County, Ohio" provided by Stantec dated January 29, 2024. The information provided in the referenced Stantec, January 29, 2024 report serves as a basis for this SFE report and can be found in Appendix 1B. Each individual project boring log can be found within referenced Stantec document as well as within Appendix 1C of this report. A summary of the location and elevation information of the borings are shown on Table 1 below. The boring locations are depicted within the Boring Location Plan provided in Appendix 1A.

Table 1: Stantec Project Boring Summary

Boring Number	Latitude	Longitude	Elevation (NAVD 88) (ft)	Depth (ft)	Structure / Boring Type
B-001-0-23	39.729686	-83.936960	838.0	51.5	Retaining Wall / Rear Abutment
B-002-0-23	39.729607	-83.936608	835.0	51.5	Pier 1
B-003-0-23	39.729652	-83.935831	828.0	51.5	Pier 3
B-004-0-23	39.729494	-83.935199	831.0	51.5	Forward Abutment
Notes:					
1. As-drilled boring location and corresponding ground surface elevation was surveyed in the field by Stantec.					

With respect to historical boring logs within the project limits, a boring log search was performed utilizing the ODOT Transportation Information Mapping System (TIMS), however, no historical information was found within the area.

1.2.5. Field Reconnaissance

A field reconnaissance visit for the overall project area was conducted on November 15, 2024, within the project limits. Site conditions, including the existing land conditions and pavement conditions, were noted and photographed during the visit. Photographs of notable features and a summary of our observations are provided below. During our field reconnaissance, no geohazards were observed within the project limits. The land use of most of the project area consists of ODOT right-of-way (ROW), farmland/agricultural/vacant land, single-family homes, and commercial properties.

In general, the proposed bridge and safe access path alignment were previously occupied by houses which have since been removed. Currently, the area consists of a gravel parking lot located to the west of US-68 while pavement and agricultural/vacant land to the east. The existing agricultural/vacant land is vegetated with a mix of small to large trees, along with some bushes (Photograph 2).

At the time of our reconnaissance, the pavement conditions within the project area were observed to be in good condition with some signs of weathering and surface wear. Low severity raveling and occasional transverse cracks were observed. With respect to drainage, no evidence of standing water was noted in the project area. No signs of geotechnical instability were observed at the time of reconnaissance.

Photograph 1: US-68 Pavement



Photograph 2: Project Area



1.3 GEOTECHNICAL EXPLORATION

1.3.1. Field Exploration Program

The exploration for the project was conducted by NEAS between November 25, 2024 and December 6, 2024, including 5 borings drilled to depths between 10 and 61.5 ft bgs. The boring locations were selected by NEAS in general accordance with the guidelines contained in the SGE and to supplement the previously performed Stantec borings with the intent to evaluate subsurface soil and groundwater conditions at the site. Borings were located within the footprint of the planned structures in areas that were not restricted by underground utilities or dictated terrain (i.e., steep embankment slopes). Each as-drilled project boring location and corresponding ground surface elevation was surveyed in the field by NEAS prior to drilling operations utilizing a hand-held GPS unit. Each individual project boring log (included within Appendix 1C) includes the recorded boring latitude and longitude location (based on the surveyed Ohio State Plane South, NAD83, location) and the corresponding ground surface elevation. Coordinates, elevations and depths of the borings are shown in Table 2 below and boring locations are depicted on the Boring Location Plan provided in Appendix 1A.

Structure Foundation Exploration Report
GRE-68-12.65
Greene County, Ohio
PID: 115388

Table 2: Project Boring Summary

Boring Number	Latitude	Longitude	Elevation (NAVD 88) (ft)	Depth (ft)	Structure / Boring Type
B-001-1-24	39.729492	-83.936971	836.4	36.5	Retaining Wall
B-001-2-24	39.729506	-83.937338	840.7	36.5	Retaining Wall
B-001-3-24	39.729713	-83.937305	840.8	36.5	Retaining Wall
B-002-1-24	39.729635	-83.936183	828.3	61.5	Pier 2
B-003-1-24	39.729586	-83.935762	826.7	10.0	Pier 3 (Scour)
<i>Notes:</i> 1. As-drilled boring location and corresponding ground surface elevation was surveyed in the field by NEAS.					

Borings were drilled using a CME 55TB track-mounted drilling rig utilizing 3.25-inch diameter hollow stem augers. Soil samples were generally recovered using a split spoon sampler (AASHTO T-206 “Standard Method for Penetration Test and Split Barrel Sampling of Soils.”) at intervals of 2.5-ft to a depth of 35 ft bgs and at 5-ft intervals thereafter until boring termination. The soil samples obtained from the exploration program were visually observed in the field by the NEAS field representative and preserved for review by a Geologist and possible laboratory testing. Standard penetration tests (SPT) were conducted using CME auto hammers that have been calibrated to be 89% efficient as indicated on the boring logs.

Field boring logs were prepared by drilling personnel, and included lithological description, SPT results recorded as blows per 6-inch increment of penetration and estimated unconfined shear strength values on specimens exhibiting cohesion (using a hand penetrometer). Groundwater level observations were recorded both during and after the completion of drilling. These groundwater level observations are included on the individual boring logs. After completing the borings, the boreholes were backfilled with either auger cuttings, bentonite chips, or a combination of these materials.

1.3.2. Laboratory Testing Program

The laboratory testing program consisted of classification testing, moisture content determinations, and sulfate content testing. Data from the laboratory testing program were incorporated onto the boring logs (Appendix 1B). Soil samples are retained at the laboratory for 60 days following report submittal, after which time they will be discarded.

1.3.2.1. Classification Testing

Representative soil samples were selected for index property (Atterberg Limits) and gradation testing for classification purposes on approximately thirty-five percent (35%) of the samples. At each boring location, samples were selected for testing with the intent of identification and classification of all significant soil units. Soils not selected for testing were compared to laboratory tested samples and classified visually. Moisture content testing was conducted on all samples. The laboratory testing was performed in general accordance with applicable AASHTO specifications and ODOT Supplements.

Final classification of soil strata in accordance with AASHTO M-145 “Classification of Soils and Soil-Aggregate Mixtures for Highway Construction Purposes,” as modified by ODOT “Classification of Soils” was made once laboratory test results became available. The results of the soil classification are presented on the boring logs in Appendix 1C.

Structure Foundation Exploration Report

GRE-68-12.65

Greene County, Ohio

PID: 115388

1.3.2.2. Standard Penetration Test Results

Standard Penetration Tests (SPT) and split-barrel (commonly known as split-spoon) sampling of soils were performed at varying intervals (i.e., continuous, 2.5-ft intervals, and 5-ft intervals) in the project borings performed. To account for the high efficiency (automatic) hammers used during SPT sampling, field SPT N-values were converted based on the calibrated efficiency (energy ratio) of the specific drill rig's hammer. Field N-values were converted to an equivalent rod energy of 60% (N_{60}) for use in analysis or for correlation purposes. The resulting N_{60} values are shown on the boring logs provided in Appendix 1C.

1.3.2.3. Consolidation Testing

One (1) consolidation test was performed in accordance with ASTM D 2435-04 "Standard Test Methods for One-Dimensional Consolidation Properties of Soils Using Incremental Loading" on a relatively undisturbed cohesive soil sample (classified on the log as Clay) collected from boring B-001-3-24. The results of the consolidation tests are presented in Table 3 below, while the laboratory testing reports are included with the associated boring log within Appendix 1C.

Table 3: Consolidation Test Results

Boring Number	Sample ID	Depth (ft)	Elevation (ft)	Compression Index (Cc)	Recompression Index (Cr)	Preconsolidation Pressure (psf)	Void Ratio
B-001-3-24	ST-2	2.6 - 2.7	838.2 - 838.1	0.166	0.013	2,000	0.707

1.3.2.4. Streambed Grain Size Distribution

Streambed sampling was performed within the boring samples obtained at streambed elevation to obtain representative samples of potential streambed soils. Grain size distribution testing was performed on the obtained streambed samples to develop D_{50} values (i.e., the diameter in the particle-size distribution curve corresponding to 50% finer) for use in scour analysis. The calculated D_{50} values are shown in Table 4 below and gradation charts are included with the boring logs within Appendix 1C.

Table 4: Streambed Grain Size Analysis Results

Boring Number	Specimen Depth (ft)	Specimen Elevation (ft)	ODOT (Modified AASHTO) / USCS Classification	D50
B-002-1-24	2.5 - 4.0	825.7 - 824.3	A-6b / CLAYEY SAND with GRAVEL(SC)	0.148
	5.0 - 6.5	823.3 - 821.8	A-6b / CLAYEY SAND with GRAVEL(SC)	0.081
	7.5 - 9.0	820.8 - 819.3	A-2-4 / SILTY SAND with GRAVEL(SM)	0.931
	12.5 - 14.0	815.8 - 814.3	A-4b / SANDY SILT(ML)	0.050
	17.5 - 19.0	810.8 - 809.3	A-4a / SANDY LEAN CLAY(CL)	0.064
B-003-1-24	1.0 - 2.5	825.7 - 824.2	A-6a / LEAN CLAY with SAND(CL)	0.021
	2.5 - 4.0	824.2 - 822.7	A-6a / SANDY LEAN CLAY(CL)	0.073
	4.0 - 5.5	822.7 - 821.2	A-6a / SANDY LEAN CLAY(CL)	0.024
	7.0 - 8.5	819.7 - 818.2	A-2-4 / SILTY SAND with GRAVEL(SM)	0.435

1.4 FINDINGS, ANALYSES AND RECOMMENDATIONS

The subsurface conditions encountered during the project subsurface explorations are described in the following sections of this report and/or on each boring log presented in Appendix 1C. The boring logs represent an interpretation of the subsurface conditions encountered at each boring location based on our

Structure Foundation Exploration Report

GRE-68-12.65

Greene County, Ohio

PID: 115388

site observations, field logs, visual review of the soil samples by NEAS's geologist, and laboratory test results. The lines designating the interfaces between various soil strata on the boring logs represent the approximate interface location; the actual transition between strata may be gradual and indistinct. The subsurface soil and groundwater characterizations included herein, including summary test data, are based on the subsurface findings from the geotechnical explorations performed as part of the referenced project.

A summary of the subsurface conditions as well as analyses and recommendations for specific structures (i.e. bridge and retaining walls) are provided within their dedicated section of this report. The specific design elements included within this report for the GRE-68-12.65 project include:

- Section 2: Pedestrian Bridge over Oldtown Creek and US-68; and,
- Section 3: Retaining Walls.

1.5 QUALIFICATIONS

This investigation was performed in accordance with accepted geotechnical engineering practice for the purpose of characterizing the subsurface conditions at locations of the proposed project structures. This report has been prepared for Carpenter Marty Transportation, ODOT and their design consultants to be used solely in evaluating the subsurface conditions within the project limits and presenting geotechnical engineering recommendations specific to this project. The assessment of general site environmental conditions or the presence of pollutants in the soil, rock and groundwater of the site was beyond the scope of this geotechnical exploration. Our recommendations are based on the results of our field explorations, laboratory test results from representative soil samples, and geotechnical engineering analyses. The results of the field explorations and laboratory tests, which form the basis of our recommendations, are presented in the appendices as noted. This report does not reflect any variations that may occur between the borings or elsewhere on the site, or variations whose nature and extent may not become evident until a later stage of construction. In the event that any changes occur in the nature, design or location of the proposed project structures, the conclusions and recommendations contained in this report should not be considered valid until they are reviewed and have been modified or verified in writing by a geotechnical engineer.

It has been a pleasure to be of service to Carpenter Marty Transportation in performing this geotechnical exploration for the GRE-68-12.65 project. Please call if there are any questions, or if we can be of further service.

Respectfully Submitted,

Brendan P. Andrews, P.E.
Project Geotechnical Engineer

Momen Alassi E.I.T.
Geotechnical Staff Engineer

REFERENCES

- AASHTO. (2020). *LRFD Bridge Design Specifications; 9th Edition*. Washington, D.C.: American Association of State Highway and Transportation Officials.
- FEMA. (2024). *National Flood Hazard Layer kmz v3.0*. Federal Emergency Management Agency.
- ODGS. (1998). Physiographic regions of Ohio: Ohio Department of Natural Resources, Division of Geological Survey. page-size map with text, 2p., scale 1:2,100,00.
- ODNR [1]. (2016). Ohio Abandoned Mine Locator Interactive Map. *Mines of Ohio*. Ohio Department of Natural Resources, Division of Geological Survey & Division of Mineral Resources. Retrieved from <https://gis.ohiodnr.gov/MapView/?config=OhioMines>
- ODNR [2]. (2016). Ohio Oil & Gas Locator Interactive Map. *Ohio Oil & Gas Wells*. Ohio Department of Natural Resources, Division of Oil and Gas. Retrieved from <https://gis.ohiodnr.gov/MapView/?config=oilgaswells>
- ODOT. (2024). *2020 Bridge Design Manual*. Columbus, OH: Ohio Department of Transportation: Office of Structural Engineering. Retrieved from <https://www.dot.state.oh.us/divisions/engineering/structures/standard/bridges/bdm/forms/bdm.aspx>
- ODOT. (2024). *Geotechnical Design Manual* (July 2024 ed.). Columbus, Ohio: Ohio Department of Transportation: Office of Geotechnical Engineering.
- ODOT. (2024). *Specifications for Geotechnical Explorations*. Ohio Department of Transportation: Office of Geotechnical Engineering.

APPENDIX 1A

BORING LOCATION PLAN

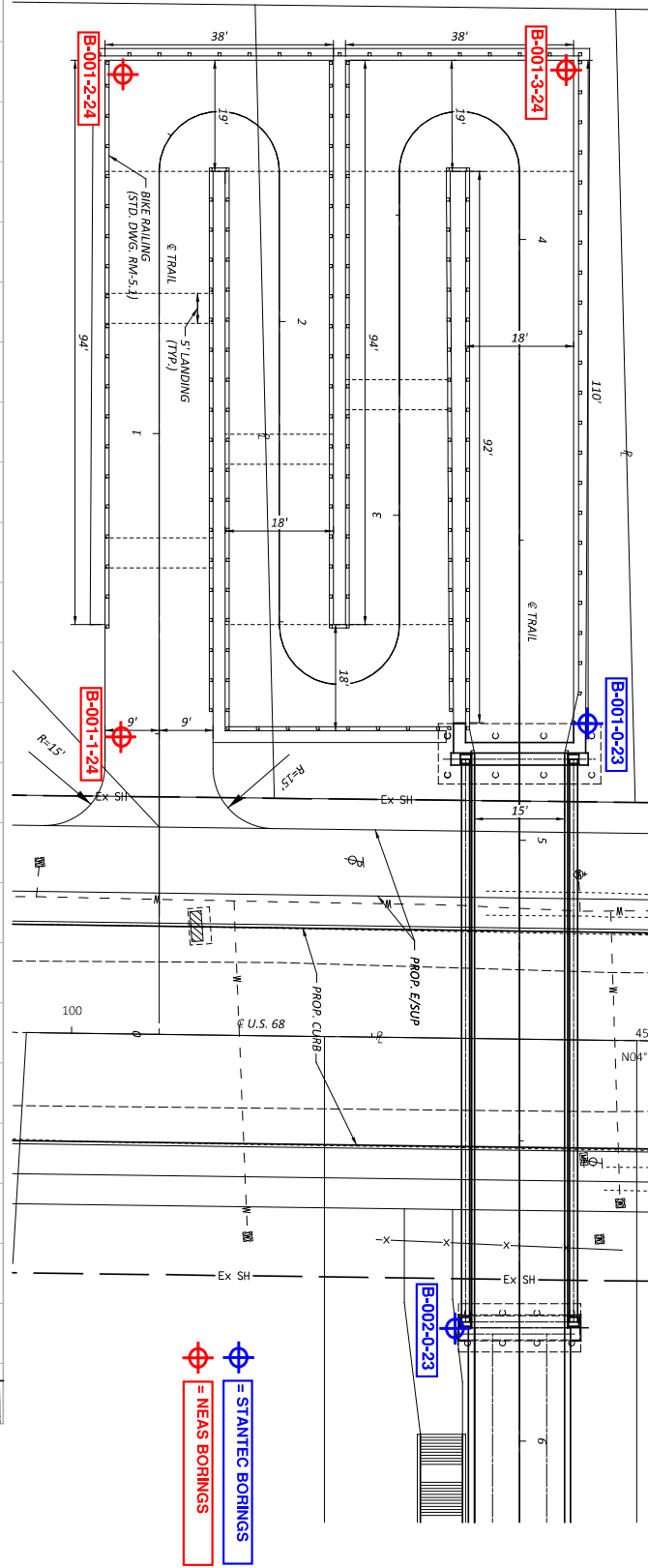
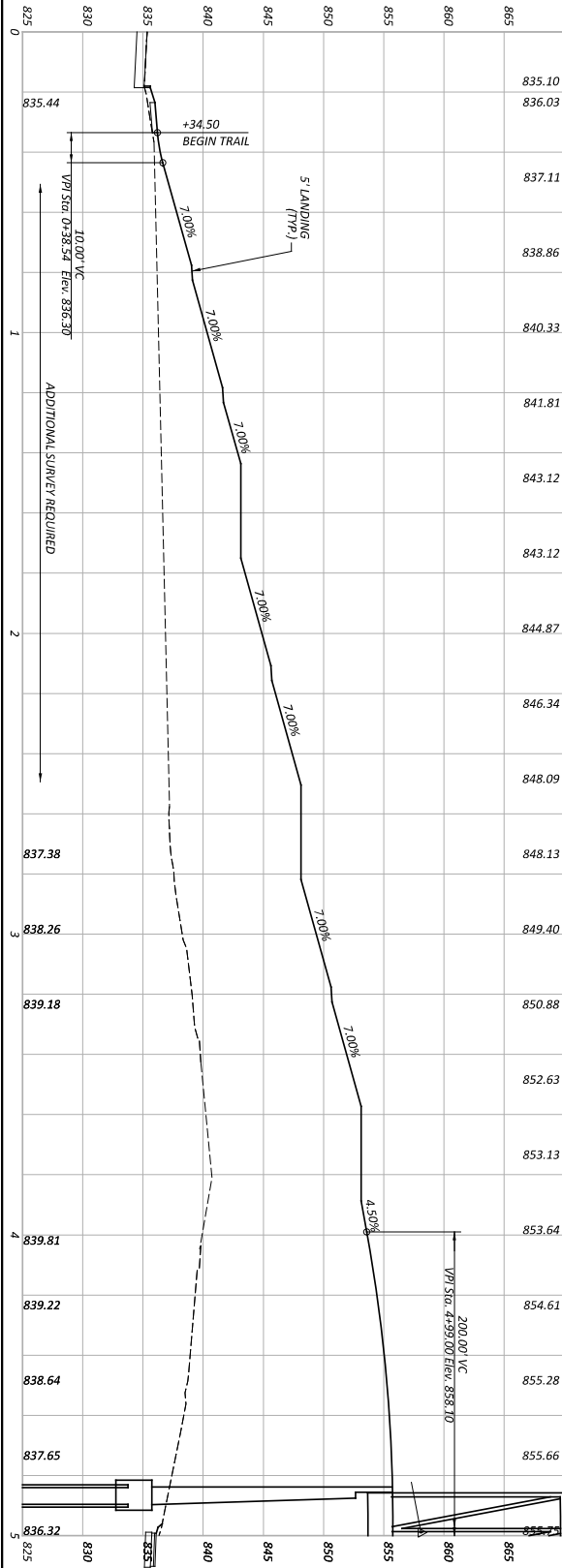

= NEAS BORINGS
 = STANTEC BORINGS

DESIGN AGENCY	CARPENTER MARTY
DESIGNER	DMG
REVIEWER	BAA 07/09/24
PROJECT NO.	115388
SHEET TOTAL	0

PLAN AND PROFILE
 SUP SWITCHBACK GEOMETRY

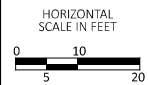

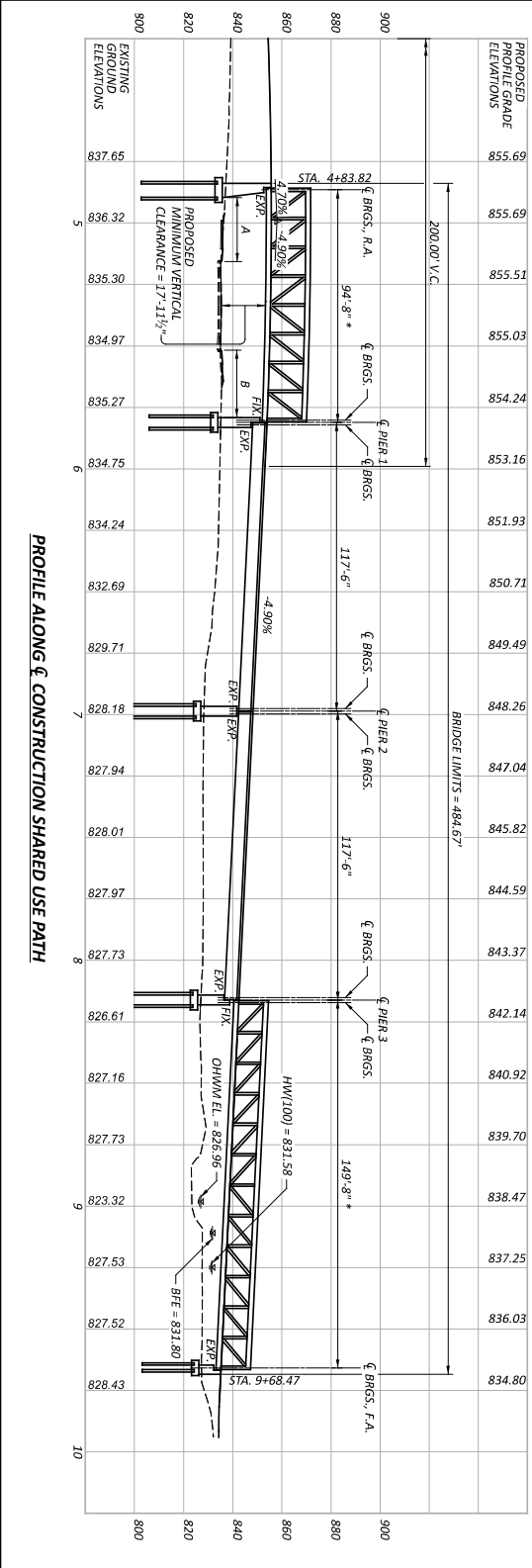

PROFILE ALONG & CONSTRUCTION SHARED USE PATH

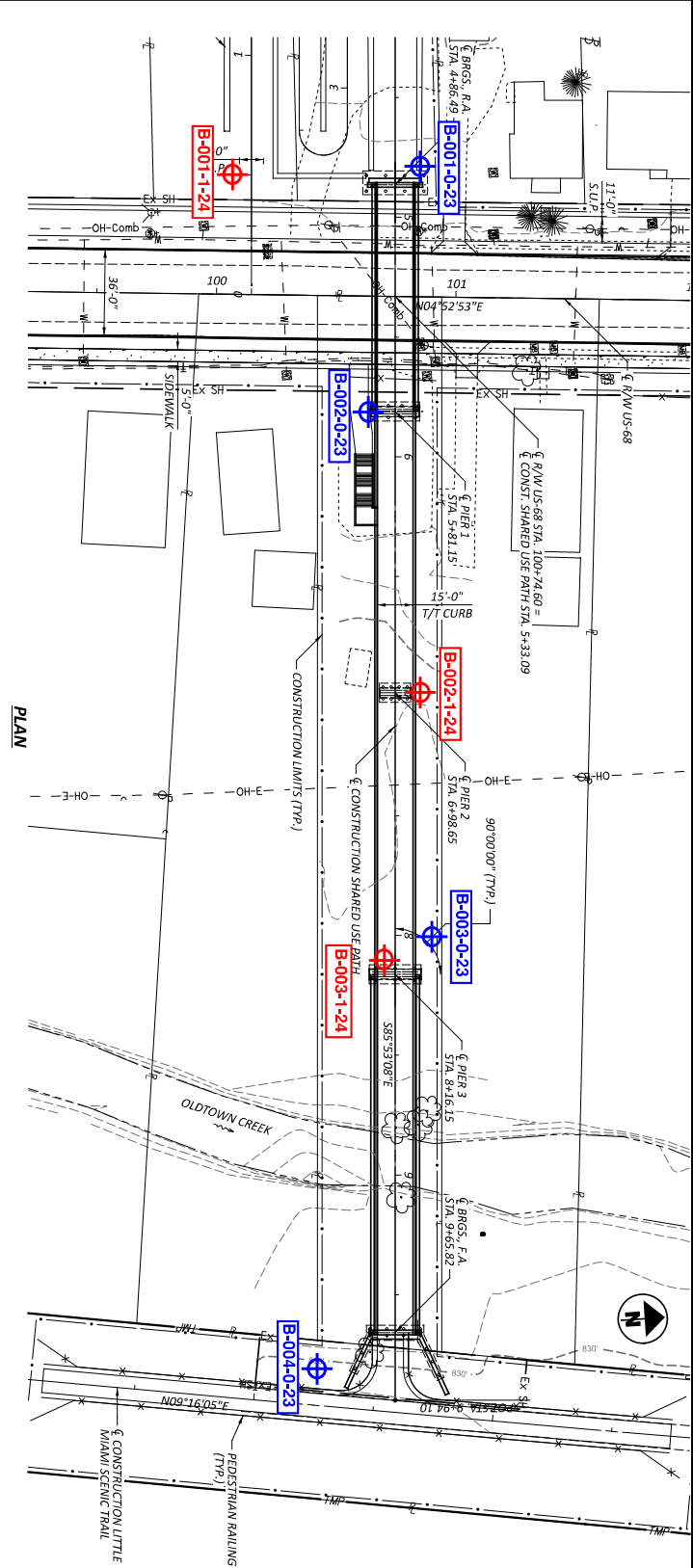

PLAN

PROPOSED STRUCTURE	
TYPE:	EQUIS SPAN PRECAST/PREFABRICATED PAINTED STEEL TRUSS AND WIDE FLANGE BEAM SUPERSTRUCTURE WITH REINFORCED CONCRETE DECK ON REINFORCED CONCRETE ABUTMENTS AND PIERS SUPPORTED ON CAST-IN-PLACE REINFORCED CONCRETE PILES
SPANS:	94'-8", 117'-6", 117'-6", 149'-8"
ROADWAY:	15'-0" T/OE/TOE CURB
LOADING:	0.090 KSF PEDESTRIAN LOAD
SKEV:	NONE
WEARING SURFACE:	1" MONOLITHIC CONCRETE
APPROACH SLABS:	NONE
ALIGNMENT:	NONE
CROWN:	0.01 F/T/T
DECK AREA:	8,180 SF
COORDINATES:	LATITUDE N39°43'46.65" LONGITUDE W83°56'12.36"

LEGEND

- A - MINIMUM HORIZONTAL CLEARANCE = 25'-4 1/2"
- B - MINIMUM HORIZONTAL CLEARANCE = 28'-2 3/4"
- * - DIMENSION MAY VARY BASED ON SELECTED TRUSS FABRICATION

= STANTEC BORINGS
 = NEAS BORINGS

DESIGN AGENCY	CARPENTER MARTY
DATE	2/29/2017
PROJECT NO.	115388
DESIGNER	SMH
CHECKER	AMR
DATE	07-08-24
SHEET NO.	1
TOTAL SHEETS	7
PLOTTED	0

SITE PLAN
 BRIDGE NO. GRE-BK80020-00.492
 PEDESTRIAN BRIDGE OVER US 68 AND OLDTOWN CREEK

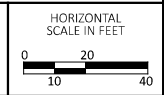

APPENDIX 1B

STANTEC PREVIOUS PHASES OF PROJECT EXPLORATION LETTER



Stantec Consulting Services Inc.
10200 Alliance Road Suite 300, Cincinnati OH 45242

January 29, 2024
File: 175578516

Attention: Alec Sadowski, PE
Ohio Department of Transportation, District 8
505 South SR 741
Lebanon, Ohio 45036

Reference: Geotechnical Exploration Logs
GRE-68-12.65, PID 115388
Greene County, Ohio

Dear Mr. Sadowski,

Stantec Consulting Services Inc. (Stantec) has completed the geotechnical exploration and boring logs for the proposed pedestrian bridge connecting the Little Miami Scenic Trail and the new Shawnee Interpretive Education Center located at GRE-68-12.65 in Greene County, Ohio. The bridge will cross US 68 and Oldtown Creek. Enclosed are the completed boring logs and laboratory results completed by UES (formerly Geotechnology) to assist in design of the proposed bridge.

Regards,

Stantec Consulting Services Inc.

James Samples EI
Project Engineer in Training

Phone: (513) 842-8204
James.Samples@stantec.com

Eric Kistner PE
Geotechnical Project Manager

Phone: (513) 842-8213
Eric.Kistner@stantec.com

Attachment: GRE-68-12.65 Boring Logs, UES Lab Report

PID:	115388	SFN:	N/A	PROJECT:	GRE-68-12.65	STATION / OFFSET:	TBD	START:	1/2/24	END:	1/3/23	PG 2 OF 2	B-001-0-23						
MATERIAL DESCRIPTION AND NOTES		ELEV.	DEPTHS	SPT/ ROD	N ₆₀	REC (%)	SAMPLE ID	HP (tsf)	GR	CS	FS	SI	CL	LL	PL	PI	WC	ODOT CLASS (G)	HOLE SEALED
MEDIUM DENSE TO DENSE, BROWN TO LIGHT GRAY, GRAVEL AND STONE FRAGMENTS WITH SAND, LITTLE SILT, TRACE CLAY, MOIST TO WET (continued)		808.0	27																
			28																
MEDIUM DENSE TO DENSE, BROWNISH GRAY, GRAVEL AND STONE FRAGMENTS, SOME SAND, TRACE SILT, TRACE CLAY, WET		788.0	29																
			30	8	15	42	83	SS-11	-	53	27	8	8	4	18	17	1	12	A-1-a (0)
COBBLES ENCOUNTERED FROM 46.0 to 47.0 FEET		786.5	31	9	11	30	78	SS-12	-	53	27	8	8	4	18	17	1	15	A-1-a (0)
			32																
HARD, GRAY, SANDY SILT, TRACE TO LITTLE GRAVEL, SOME CLAY, GLACIAL TILL, DAMP		786.5	33																
			34																
HARD, GRAY, SANDY SILT, TRACE TO LITTLE GRAVEL, SOME CLAY, GLACIAL TILL, DAMP		786.5	35																
			36	9	13	42	83	SS-11	-	53	27	8	8	4	18	17	1	12	A-1-a (0)
HARD, GRAY, SANDY SILT, TRACE TO LITTLE GRAVEL, SOME CLAY, GLACIAL TILL, DAMP		786.5	37																
			38																
HARD, GRAY, SANDY SILT, TRACE TO LITTLE GRAVEL, SOME CLAY, GLACIAL TILL, DAMP		786.5	39																
			40	7	15	36	72	SS-13	-	53	27	8	8	4	18	17	1	11	A-1-a (V)
HARD, GRAY, SANDY SILT, TRACE TO LITTLE GRAVEL, SOME CLAY, GLACIAL TILL, DAMP		786.5	41																
			42																
HARD, GRAY, SANDY SILT, TRACE TO LITTLE GRAVEL, SOME CLAY, GLACIAL TILL, DAMP		786.5	43																
			44																
HARD, GRAY, SANDY SILT, TRACE TO LITTLE GRAVEL, SOME CLAY, GLACIAL TILL, DAMP		786.5	45																
			46	7	50/5"	-	100	SS-14	-	53	27	8	8	4	18	17	1	12	A-1-a (V)
HARD, GRAY, SANDY SILT, TRACE TO LITTLE GRAVEL, SOME CLAY, GLACIAL TILL, DAMP		786.5	47																
			48																
HARD, GRAY, SANDY SILT, TRACE TO LITTLE GRAVEL, SOME CLAY, GLACIAL TILL, DAMP		786.5	49																
			50	13	21	74	100	SS-15	4.50	-	-	-	-	-	-	-	-	11	A-4a (V)
HARD, GRAY, SANDY SILT, TRACE TO LITTLE GRAVEL, SOME CLAY, GLACIAL TILL, DAMP		786.5	51																
			52																

NOTES: GPS COORDINATES DETERMINED BY CELL PHONE. ELEVATION ESTIMATED USING GPS COORDINATES AND GOOGLE EARTH TOPOGRAPHIC DATA.
 ABANDONMENT METHODS, MATERIALS, QUANTITIES: BENTONITE, AUGER CUTTINGS MIXED WITH BENTONITE POWDER

PROJECT: GRE-68-12.65		DRILLING FIRM / OPERATOR: _____		UES / TG		DRILL RIG: _____		UES CME 55		STATION / OFFSET: _____		TBD		EXPLORATION ID							
TYPE: STRUCTURE FOUNDATION		SAMPLING FIRM / LOGGER: _____		STANTEC / JS		HAMMER: _____		CME AUTOMATIC		ALIGNMENT: _____		US 68		B-002-0-23							
PID: 115388 SFN: N/A		DRILLING METHOD: _____		3.25" HSA		CALIBRATION DATE: 7/17/23		ELEVATION: 835.0 (MSL)		EOB: 51.5 ft.		PAGE		1 OF 2							
START: 1/3/23 END: 1/3/23		SAMPLING METHOD: _____		SPT / ST		ENERGY RATIO (%): 90*		LAT / LONG: 39.729607, -83.936608													
MATERIAL DESCRIPTION AND NOTES																					
GRAY GRAVEL, 2 INCHES		ELEV. 835.0		DEPTHS		SPT/ RQD		REC SAMPLE ID		HP (tsf)		GR CS FS SI CL		ATTERBERG		WC		ODOT CLASS (g)		SOLE SEALED	
STIFF, LIGHT BROWN TO BROWN, SILT AND CLAY, TRACE GRAVEL, SOME SAND, DAMP TO MOIST		834.8		1		3		SS-1		1.25		1 8 24 41 26		35 20 15		25		A-6a (8)		✓	
		831.0		2																✓	
				3		3		SS-2		2.75		1 8 24 41 26		35 20 15		20		A-6a (8)		✓	
				4		4		SS-1		-		42 20 10 18 10		23 22 1		13		A-24 (0)		✓	
				5		12		SS-3		-		-		-		3		A-24 (V)		✓	
				6		20		SS-4		-		-		-		7		A-24 (V)		✓	
				7		9		SS-4		-		-		-		4		A-24 (V)		✓	
				8		7		SS-5		-		-		-		5		A-24 (V)		✓	
				9		13		SS-6		-		-		-		8		A-24 (V)		✓	
				10		14		SS-7		-		-		-		5		A-24 (V)		✓	
				11		6		SS-8		-		-		-		5		A-1-a (V)		✓	
				12		10		SS-9		-		-		-		12		A-1-a (0)		✓	
				13		11		SS-10		-		-		-		16		A-1-a (0)		✓	
				14		10		SS-11		-		-		-		13		A-1-a (V)		✓	
				15		11				-		-		-						✓	
				16		10				-		-		-						✓	
				17		12				-		-		-						✓	
				18		15				-		-		-						✓	
				19		28				-		-		-						✓	
				20		18				-		-		-						✓	
				21		16				-		-		-						✓	
				22		15				-		-		-						✓	
				23		9				-		-		-						✓	
				24		11				-		-		-						✓	
				25		16				-		-		-						✓	
				26		4				-		-		-						✓	
				26		5				-		-		-						✓	
				26		11				-		-		-						✓	
MEDIUM DENSE TO DENSE, GRAY, GRAVEL AND STONE FRAGMENTS, SOME SAND, TRACE SILT, TRACE CLAY, MOIST TO WET VERY DENSE AT SS-8		818.0		17						-		-		-						✓	
				18						-		-		-						✓	
				19						-		-		-						✓	
				20						-		-		-						✓	
				21						-		-		-						✓	
				22						-		-		-						✓	
				23						-		-		-						✓	
				24						-		-		-						✓	
				25						-		-		-						✓	
				26						-		-		-						✓	

PID: 115388		SFN: N/A		PROJECT: GRE-68-12.65		STATION / OFFSET: TBD		START: 1/3/23		END: 1/3/23		PG 2 OF 2		B-002-0-23									
MATERIAL DESCRIPTION AND NOTES				ELEV.	DEPTHS	SPT/ RQD	N ₆₀	REC (%)	SAMPLE ID	HP (tsf)	GRADATION (%)			ATTEMBERG	WC	ODOT CLASS (G)	SOLE SEALED						
MEDIUM DENSE TO DENSE, GRAY, GRAVEL AND STONE FRAGMENTS, SOME SAND, TRACE SILT, TRACE CLAY, MOIST TO WET (continued)				808.5	27						GR	CS	FS	SI	CL	LL	PL	PI					
HARD, GRAY, SANDY SILT, LITTLE GRAVEL, SOME CLAY, GLACIAL TILL, DAMP				805.0	28																		
					29																		
HARD, GRAY, SILT, SOME SAND, TRACE CLAY, GLACIAL TILL, MOIST TO WET				795.0	30	19	99	100	SS-12	4.50	11	21	22	20	26	21	13	8	9	A-4a (2)			
					31	27	39																
					32																		
					33																		
					34																		
					35																		
					36	15	30	99	100	SS-13	4.50	11	21	22	20	26	21	13	8	9	A-4a (2)		
					37		36																
					38																		
					39																		
					40	8																	
					41	18	20	57	100	SS-14	-	0	1	32	60	7	20	20	NP	25	A-4b (6)		
					42																		
					43																		
					44																		
					45																		
					46	10	19	74	100	SS-15	-	0	1	32	60	7	20	20	NP	17	A-4b (6)		
					47		30																
					48																		
					49																		
					50																		
					51	9	26	81	100	SS-16	4.50	-	-	-	-	-	-	-	-	-	-	13	A-4b (V)

NOTES: GPS COORDINATES DETERMINED BY CELL PHONE. ELEVATION ESTIMATED USING GPS COORDINATES AND GOOGLE EARTH TOPOGRAPHIC DATA.
 ABANDONMENT METHODS, MATERIALS, QUANTITIES: BENTONITE, AUGER CUTTINGS MIXED WITH BENTONITE POWDER

PROJECT: GRE-68-12.65		DRILLING FIRM / OPERATOR: _____		UES / TG		DRILL RIG: _____		UES CME 55		STATION / OFFSET: _____		TBD		EXPLORATION ID																					
TYPE: STRUCTURE FOUNDATION		SAMPLING FIRM / LOGGER: _____		STANTEC / JS		HAMMER: _____		CME AUTOMATIC		ALIGNMENT: _____		US 68		B-003-0-23																					
PID: 115388 SFN: N/A		DRILLING METHOD: _____		3.25" HSA		CALIBRATION DATE: 7/17/23		ELEVATION: 828.0 (MSL)		EOB: 51.5 ft.		PAGE		1 OF 2																					
START: 1/3/23		END: 1/3/23		SPT		ENERGY RATIO (%): 90*		LAT / LONG: 39.729652, -83.935831																											
MATERIAL DESCRIPTION AND NOTES				ELEV.		DEPTHS		SPT/ RQD		REC SAMPLE ID		HP (lbf)		GRADATION (%)		ATTERBERG		WC		ODOT CLASS (g)		SOLE SEALED													
DARK BROWN, TOPSOIL, 3 INCHES				828.0		1		3		SS-1		1.00		-		-		-		21		A-6b (V)		✓											
STIFF, DARK BROWN TO BROWN, SILTY CLAY, LITTLE GRAVEL, TRACE SAND, DAMP				827.7		2		3		SS-1		1.00		-		-		-		21		A-6b (V)		✓											
						3		9		SS-1		1.00		-		-		-		21		A-6b (V)		✓											
						4		12		SS-2		4.50		-		-		-		23		A-6b (V)		✓											
						5		14		SS-3		-		-		-		-		14		A-1-b (V)		✓											
MEDIUM DENSE, BROWN TO GRAY, GRAVEL AND STONE FRAGMENTS WITH SAND, LITTLE SILT, TRACE CLAY, MOIST				823.0		6		5		SS-3		-		-		-		-		12		A-1-b (O)		✓											
						7		6		SS-4		-		52		17		9		18		4		21		21		NP		✓					
						8		6		SS-4		-		52		17		9		18		4		21		21		NP		✓					
						9		5		SS-4		-		52		17		9		18		4		21		21		NP		✓					
						10		6		SS-5		-		52		17		9		18		4		21		21		NP		✓					
						11		10		SS-5		-		52		17		9		18		4		21		21		NP		✓					
						12		16		SS-6		-		47		17		13		16		7		18		17		1		8		A-1-b (O)		✓	
						13		14		SS-6		-		47		17		13		16		7		18		17		1		8		A-1-b (O)		✓	
						14		9		SS-7		-		47		17		13		16		7		18		17		1		10		A-1-b (O)		✓	
						15		23		SS-7		-		47		17		13		16		7		18		17		1		10		A-1-b (O)		✓	
						16		9		SS-7		-		47		17		13		16		7		18		17		1		10		A-1-b (O)		✓	
						17		39		SS-7		-		47		17		13		16		7		18		17		1		10		A-1-b (O)		✓	
						18		16		SS-8		-		47		17		13		16		7		18		17		1		10		A-1-b (O)		✓	
						19		13		SS-8		-		47		17		13		16		7		18		17		1		10		A-1-b (O)		✓	
						20		28		SS-8		-		47		17		13		16		7		18		17		1		10		A-1-b (O)		✓	
						21		34		SS-8		-		47		17		13		16		7		18		17		1		10		A-1-b (O)		✓	
						22		11		SS-9		-		47		17		13		16		7		18		17		1		10		A-1-b (O)		✓	
						23		14		SS-9		-		47		17		13		16		7		18		17		1		10		A-1-b (O)		✓	
						24		42		SS-9		-		47		17		13		16		7		18		17		1		10		A-1-b (O)		✓	
						25		16		SS-10		4.50		10		11		21		32		26		22		15		7		12		A-4a (5)		✓	
						26		16		SS-10		4.50		10		11		21		32		26		22		15		7		12		A-4a (5)		✓	
						27		21		SS-10		4.50		10		11		21		32		26		22		15		7		12		A-4a (5)		✓	
						28		16		SS-11		4.50		10		11		21		32		26		22		15		7		12		A-4a (5)		✓	
						29		16		SS-11		4.50		10		11		21		32		26		22		15		7		12		A-4a (5)		✓	
						30		20		SS-11		4.50		10		11		21		32		26		22		15		7		12		A-4a (5)		✓	
						31		12		SS-12		4.50		10		11		21		32		26		22		15		7		12		A-4a (5)		✓	
						32		16		SS-12		4.50		10		11		21		32		26		22		15		7		12		A-4a (5)		✓	
						33		25		SS-12		4.50		10		11		21		32		26		22		15		7		12		A-4a (5)		✓	
						34		8		SS-12		4.50		10		11		21		32		26		22		15		7		12		A-4a (5)		✓	
						35		35		SS-12		4.50		10		11		21		32		26		22		15		7		12		A-4a (5)		✓	
HARD, GRAY, SANDY SILT, TRACE TO LITTLE GRAVEL, SOME CLAY, GLACIAL TILL, DAMP				808.0		36		25		SS-12		4.50		10		11		21		32		26		22		15		7		12		A-4a (5)		✓	
						37		8		SS-12		4.50		10		11		21		32		26		22		15		7		12		A-4a (5)		✓	
						38		35		SS-12		4.50		10		11		21		32		26		22		15		7		12		A-4a (5)		✓	

PID: 115388		SFN: N/A		PROJECT: GRE-68-12.65		STATION / OFFSET: TBD		START: 1/3/23		END: 1/3/23		PG 2 OF 2		B-003-0-23							
MATERIAL DESCRIPTION AND NOTES				ELEV.	DEPTHS	SPT/ ROD	N ₆₀	REC (%)	SAMPLE ID	HP (tsf)	GRADATION (%)				ATERBERG	WC	ODOT CLASS (g)	HOLE SEALED			
HARD, GRAY, SANDY SILT, TRACE TO LITTLE GRAVEL, SOME CLAY; GLACIAL TILL, DAMP (continued)				801.5							GR	CS	FS	SI	CL	LL	PL	PI			
					27																
					28																
					29																
					30																
					31	10	18	59	SS-13	4.50	-	-	-	-	-	-	-	-	-	12	A-4a (V)
					32	21															
					33																
					34																
					35	12															
					36	20	29	74	SS-14	4.50	-	-	-	-	-	-	-	-	-	11	A-4a (V)
					37																
					38																
					39																
					40																
					41	19	44	122	SS-15	4.50	-	-	-	-	-	-	-	-	-	11	A-4a (V)
					42		37														
					43																
					44																
					45																
					46	8	14	51	SS-16	4.50	5	11	23	33	28	23	22	1	12	A-4a (5)	
					47		20														
					48																
					49																
					50																
					51	9	16	51	SS-17	4.50	5	11	23	33	28	23	22	1	13	A-4a (5)	
						18															

NOTES: GPS COORDINATES DETERMINED BY CELL PHONE. ELEVATION ESTIMATED USING GPS COORDINATES AND GOOGLE EARTH TOPOGRAPHIC DATA.
 ABANDONMENT METHODS, MATERIALS, QUANTITIES: BENTONITE; AUGER CUTTINGS MIXED WITH BENTONITE POWDER

PROJECT: GRE-68-12.65		DRILLING FIRM / OPERATOR: UES / TG		DRILL RIG: UES CME 55		STATION / OFFSET: TBD		EXPLORATION ID: B-004-0-23																															
TYPE: STRUCTURE FOUNDATION		SAMPLING FIRM / LOGGER: STANTEC / JS		HAMMER: CME AUTOMATIC		ALIGNMENT: US 68		PAGE: 1 OF 2																															
PID: 115388 SFN: N/A		DRILLING METHOD: 3.25" HSA		CALIBRATION DATE: 7/17/23		ELEVATION: 831.0 (MSL)		EOB: 51.5 ft.																															
START: 1/2/24 END: 1/2/24		SAMPLING METHOD: SPT		ENERGY RATIO (%): 90*		LAT / LONG: 39.729494, -83.935199																																	
MATERIAL DESCRIPTION AND NOTES				ELEV.		DEPTHS		SPT/ RQD		REC SAMPLE ID		HP (tsf)		GR		CS		FS		SI		CL		LL		PL		PI		WC		ODOT CLASS (g)		SOLE SEALED					
DARK BROWN, TOPSOIL, 4 INCHES				830.7		3		3		11		100		SS-1		3.00		-		-		-		-		-		-		-		19		A-7-6 (V)		✓			
STIFF TO VERY STIFF, DARK BROWN TO BROWN, CLAY, TRACE GRAVEL, LITTLE TO SOME SAND, "AND" SILT, DAMP TO MOIST				818.0		4		4		11		56		SS-2		1.50		2		4		12		39		43		52		28		24		27		A-7-6 (16)		✓	
DENSE, BROWN TO GRAY, GRAVEL AND STONE FRAGMENTS WITH SAND, TRACE SILT, TRACE CLAY, MOIST TO WET				815.0		5		5		15		56		SS-5		-		2		4		18		48		28		41		23		18		6		A-7-6 (11)		✓	
DENSE TO VERY DENSE, GRAY, GRAVEL AND STONE FRAGMENTS, TRACE SILT, TRACE CLAY, WET						6		6		24		78		SS-4		4.50		-		-		-		-		-		-		-		17		A-7-6 (V)		✓			
						7		8		72		SS-3		2.00		2		4		12		39		43		52		28		24		26		A-7-6 (16)		✓			
						8		8		21		72		SS-3		2.00		2		4		12		39		43		52		28		24		26		A-7-6 (16)		✓	
						9		8		24		78		SS-4		4.50		-		-		-		-		-		-		-		17		A-7-6 (V)		✓			
						10		5		15		56		SS-5		-		2		4		18		48		28		41		23		18		6		A-7-6 (11)		✓	
						11		6		4		56		SS-5		-		2		4		18		48		28		41		23		18		6		A-7-6 (11)		✓	
						12		2		30		72		SS-6		-		2		4		18		48		28		41		23		18		8		A-7-6 (11)		✓	
						13		9		12		72		SS-6		-		2		4		18		48		28		41		23		18		8		A-7-6 (11)		✓	
						14		9		13		72		SS-7		-		49		22		13		9		7		18		16		2		11		A-1-b (0)		✓	
						15		13		39		72		SS-7		-		49		22		13		9		7		18		16		2		11		A-1-b (0)		✓	
						16		9		13		61		SS-8		-		49		22		13		9		7		18		16		2		12		A-1-b (0)		✓	
						17		12		47		100		SS-9		-		50		23		13		8		6		17		16		1		14		A-1-a (0)		✓	
						18		10		45		100		SS-10		-		50		23		13		8		6		17		16		1		12		A-1-a (0)		✓	
						19		16		14		100		SS-10		-		50		23		13		8		6		17		16		1		12		A-1-a (0)		✓	
						20		16		20		53		SS-11		-		-		-		-		-		-		-		-		10		A-1-a (V)		✓			
						21		20		15		100		SS-11		-		-		-		-		-		-		-		-		10		A-1-a (V)		✓			
						22		5		9		67		SS-12		-		-		-		-		-		-		-		-		10		A-1-a (V)		✓			
						23		9		13		67		SS-12		-		-		-		-		-		-		-		-		10		A-1-a (V)		✓			
						24		14		33		67		SS-12		-		-		-		-		-		-		-		-		10		A-1-a (V)		✓			
						25		14		38		100		SS-13		-		69		14		7		8		2		18		17		1		8		A-1-a (0)		✓	
						26		11		38		100		SS-13		-		69		14		7		8		2		18		17		1		8		A-1-a (0)		✓	

PID: 115388		SFN: N/A		PROJECT: GRE-68-12.65		STATION / OFFSET: TBD		START: 1/2/24		END: 1/2/24		PG 2 OF 2		B-004-0-23							
MATERIAL DESCRIPTION AND NOTES				ELEV.	DEPTHS	SPT/ ROD	N ₆₀	REC (%)	SAMPLE ID	HP (tsf)	GRADATION (%)			ATTERBERG	WC	ODOT CLASS (G)	HOLE SEALED				
											GR	CS	FS	SI	CL	LL	PL	PI			
DENSE TO VERY DENSE, GRAY, GRAVEL AND STONE FRAGMENTS, TRACE SILT, TRACE CLAY; WET (continued)				804.5	27																
					28																
HARD, GRAY, SANDY SILT, TRACE TO LITTLE GRAVEL, SOME CLAY, GLACIAL TILL, DAMP				796.0	29																
					30	14															
VERY DENSE, GRAY, GRAVEL AND STONE FRAGMENTS, TRACE SILT, TRACE CLAY; GLACIAL TILL, WET				795.3	31	17	14	47	72	SS-14	-	69	14	7	8	2	18	17	1	15	A-1-a (0)
					32																
HARD, GRAY, SANDY SILT, TRACE TO LITTLE GRAVEL, SOME CLAY, GLACIAL TILL, DAMP				795.3	33																
					34																
HARD, GRAY, SANDY SILT, TRACE TO LITTLE GRAVEL, SOME CLAY, GLACIAL TILL, DAMP				795.3	35	15	25	101	100	SS-15	4.50	-	-	-	-	-	-	-	-	14	A-4a (V)
					36																
HARD, GRAY, SANDY SILT, TRACE TO LITTLE GRAVEL, SOME CLAY, GLACIAL TILL, DAMP				795.3	37																
					38																
HARD, GRAY, SANDY SILT, TRACE TO LITTLE GRAVEL, SOME CLAY, GLACIAL TILL, DAMP				795.3	39																
					40	18															
HARD, GRAY, SANDY SILT, TRACE TO LITTLE GRAVEL, SOME CLAY, GLACIAL TILL, DAMP				795.3	41	29	50	119	100	SS-16	-	-	-	-	-	-	-	-	-	12	A-1-a (V)
					42																
HARD, GRAY, SANDY SILT, TRACE TO LITTLE GRAVEL, SOME CLAY, GLACIAL TILL, DAMP				795.3	43																
					44																
HARD, GRAY, SANDY SILT, TRACE TO LITTLE GRAVEL, SOME CLAY, GLACIAL TILL, DAMP				795.3	45	15															
					46	21	22	65	100	SS-17	-	-	-	-	-	-	-	-	-	-	-
HARD, GRAY, SANDY SILT, TRACE TO LITTLE GRAVEL, SOME CLAY, GLACIAL TILL, DAMP				795.3	47																
					48																
HARD, GRAY, SANDY SILT, TRACE TO LITTLE GRAVEL, SOME CLAY, GLACIAL TILL, DAMP				795.3	49																
					50	11															
HARD, GRAY, SANDY SILT, TRACE TO LITTLE GRAVEL, SOME CLAY, GLACIAL TILL, DAMP				795.3	51	16	26	63	100	SS-18	2.25	-	-	-	-	-	-	-	-	18	A-4a (V)

NOTES: GPS COORDINATES DETERMINED BY CELL PHONE. ELEVATION ESTIMATED USING GPS COORDINATES AND GOOGLE EARTH TOPOGRAPHIC DATA.
 ABANDONMENT METHODS, MATERIALS, QUANTITIES: BENTONITE, AUGER CUTTINGS MIXED WITH BENTONITE POWDER

TABLATION OF LABORATORY TESTS

Boring No.	Sample No.	Depth (ft.)		Moisture Content (%)	Dry Unit Weight (pcf)	Atterberg Limits (%)			Gradation Analysis (%)					AASHTO Classification	Unconfined Compressive Strength (psf)	
		From	To			LL	PL	PI	Gravel	Coarse Sand	Fine Sand	Silt	Clay			
B-001	S-1	0.0	1.5	18.1												
B-001	ST-2	2.0	4.0	19.1	110.6	33	17	16	0.2		4.8	16.5	40.6	37.9	A-6b	4,280
B-001	S-3	5.0	6.5	14.6												
B-001	S-4	7.5	9.0	21.4												
B-001	S-5	10.0	11.5	6.2		18	17	1	49.2	22.1	10.0	13.8	4.9	A-1-b		
B-001	S-6	12.5	14.0	5.0												
B-001	S-7	15.0	16.5	4.3												
B-001	S-8	17.5	19.0	5.8												
B-001	S-9	20.0	21.5	7.7												
B-001	S-10	22.5	24.0	10.7												
B-001	S-11	25.0	26.5	9.1												
B-001	S-12	30.0	31.5	12.0		18	17	1	52.8	27.3	7.6	8.1	4.2	A-1-a		
B-001	S-13	35.0	36.5	14.6												
B-001	S-14	40.0	41.5	11.3												
B-001	S-15	45.0	46.5	11.5												
B-001	S-16	50.0	51.5	10.9												
B-002	S-1	0.0	1.5	25.2												
B-002	S-2	2.5	4.0	20.3		35	20	15	1.8	7.6	23.5	41.2	25.9	A-6a		
B-002	ST-3	4.0	4.4	12.8		23	22	1	42.4	19.8	9.9	17.7	10.2	A-2-4		
B-002	S-4	5.0	6.5	3.3												
B-002	S-5	7.5	9.0	6.7												
B-002	S-6	10.0	11.5	4.0												
B-002	S-7	12.5	14.0	4.6												
B-002	S-8	15.0	16.5	7.6												
B-002	S-9	17.5	19.0	5.2												
B-002	S-10	20.0	21.5	11.8												
B-002	S-11	22.5	24.0	16.0		18	18	0	60.9	21.9	6.3	8.2	2.7	A-1-a		
B-002	S-12	25.0	26.5	13.4												
B-002	S-13	30.0	31.5	8.7												
B-002	S-14	35.0	36.5	8.8		21	13	8	10.2	21.4	22.0	20.4	26.0	A-4a		
B-002	S-15	40.0	41.5	24.6												
B-002	S-16	45.0	46.5	17.0		20	20	0	0.9	1.1	31.5	59.8	6.7	A-4b		
B-002	S-17	50.0	51.5	12.6												
B-003	S-1	0.0	1.5	21.0												
B-003	S-2	2.5	4.0	23.2												

TABLATION OF LABORATORY TESTS

Boring No.	Sample No.	Depth (ft.)		Moisture Content (%)	Dry Unit Weight (pcf)	Atterberg Limits (%)			Gradation Analysis (%)					AASHTO Classification	Unconfined Compressive Strength (psf)	
		From	To			LL	PL	PI	Gravel	Coarse Sand	Fine Sand	Silt	Clay			
B-003	S-3	5.0	6.5	13.7												
B-003	S-4	7.5	9.0	11.8												
B-003	S-5	9.0	10.5	7.7		21	21	0	51.9	17.5	8.8	18.0	3.8	A-1-b		
B-003	S-6	10.5	12.0	8.0		18	17	1	47.2	16.7	12.7	16.0	7.4	A-1-b		
B-003	S-7	12.0	13.5	9.5												
B-003	S-8	15.0	16.5	13.4												
B-003	S-9	17.5	19.0	7.1												
B-003	S-10	20.0	21.5	11.5												
B-003	S-11	22.5	24.0	11.3		22	15	7	9.4	11.4	20.9	32.3	26.0	A-4a		
B-003	S-12	25.0	26.5	13.4												
B-003	S-13	30.0	31.5	11.9												
B-003	S-14	35.0	36.5	10.6												
B-003	S-15	40.0	41.5	10.6												
B-003	S-16	45.0	46.5	12.1		23	22	1	5.5	10.9	22.8	32.7	28.1	A-4a		
B-003	S-17	50.0	51.5	12.7												
B-004	S-1	0.0	1.5	18.8												
B-004	S-2	2.5	4.0	26.6												
B-004	S-3	5.0	6.5	25.6		52	28	24	1.9	3.9	11.9	39.2	43.1	A-7-6		
B-004	S-4	7.5	9.0	17.1												
B-004	S-5	10.0	11.5	6.0												
B-004	S-6	11.5	13.0	8.3		41	23	18	1.5	3.8	18.4	48.6	27.7	A-7-6		
B-004	S-7	13.0	14.5	11.1												
B-004	S-8	14.5	16.0	12.3		18	16	2	49.9	21.9	13.3	8.8	7.0	A-1-b		
B-004	S-9	16.0	17.5	13.5												
B-004	S-10	17.5	19.0	12.0		17	16	1	50.0	23.2	12.9	7.5	6.4	A-1-a		
B-004	S-11	20.0	21.5	9.7												
B-004	S-12	22.5	24.0	9.9												
B-004	S-13	25.0	26.5	8.1												
B-004	S-14	30.0	31.5	15.3		18	17	1	68.7	14.3	6.6	8.0	2.4	A-1-a		
B-004	S-15	35.0	36.5	13.5												
B-004	S-16	40.0	41.5	11.7												
B-004	S-17	45.0	46.5	10.8												
B-004	S-18	50.0	51.5	17.6												



GEOTECHNOLOGY

A Universal Engineering Sciences Company

PARTICLE-SIZE ANALYSIS OF SOILS AASHTO T88

Client:	Stantec Consulting Services, Inc.				Project No.:	J039684.02													
Project:	Laboratory Testing Services, GRE-68-12.65 PID115388, ODOT Dist 7/8 Task Order, Oldtown, OH				Date:	01/17/2024													
Boring No.:	B-001	Sample No.:	S-5 & 6	Depth (ft.):	10.0	Gravel (%)	49.2	Coarse Sand (%)	22.1	Fine Sand (%)	10.0	Silt (%)	13.8	Clay (%)	4.9	ODOT	A-1-b		
Sample Description:	Gravel and Stone Fragments with Sand														LL	PL	PI	Group Index	WC (%)
															18	17	1	0	

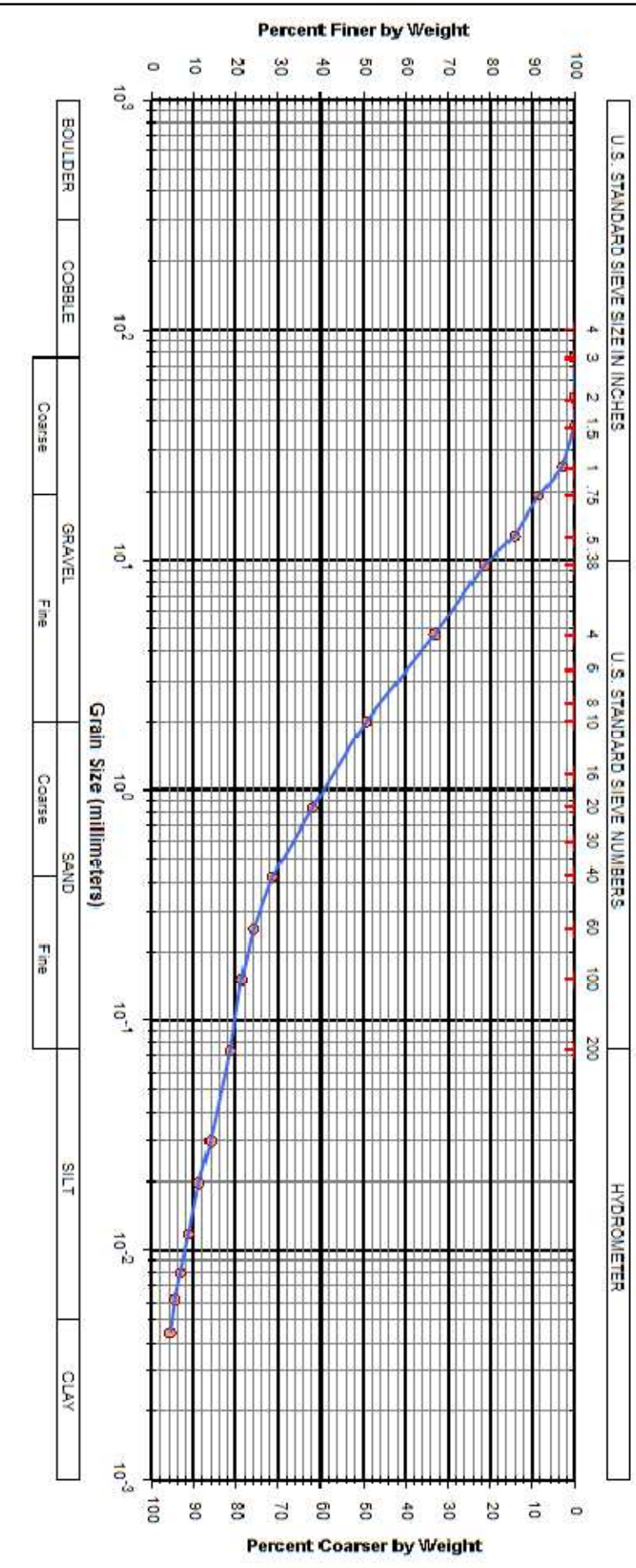



GEOTECHNOLOGY

A Universal Engineering Sciences Company

PARTICLE-SIZE ANALYSIS OF SOILS AASHTO T88

Client:	Stantec Consulting Services, Inc.				Project No.:	J039684.02	
Project:	Laboratory Testing Services, GRE-68-12.65 PID115388, ODOT Dist 7/8 Task Order, Oldtown, OH				Date:	01/17/2024	
Boring No.:	B-001	Sample No.:	S-12 & 13	Depth (ft.):	30.0	ODOT	
Sample Description:	Gravel and Stone Fragments					Gravel (%)	52.8
						Coarse Sand (%)	27.3
						Fine Sand (%)	7.6
		LL	PL	PI	Group Index	WC (%)	
		18	17	1	0		

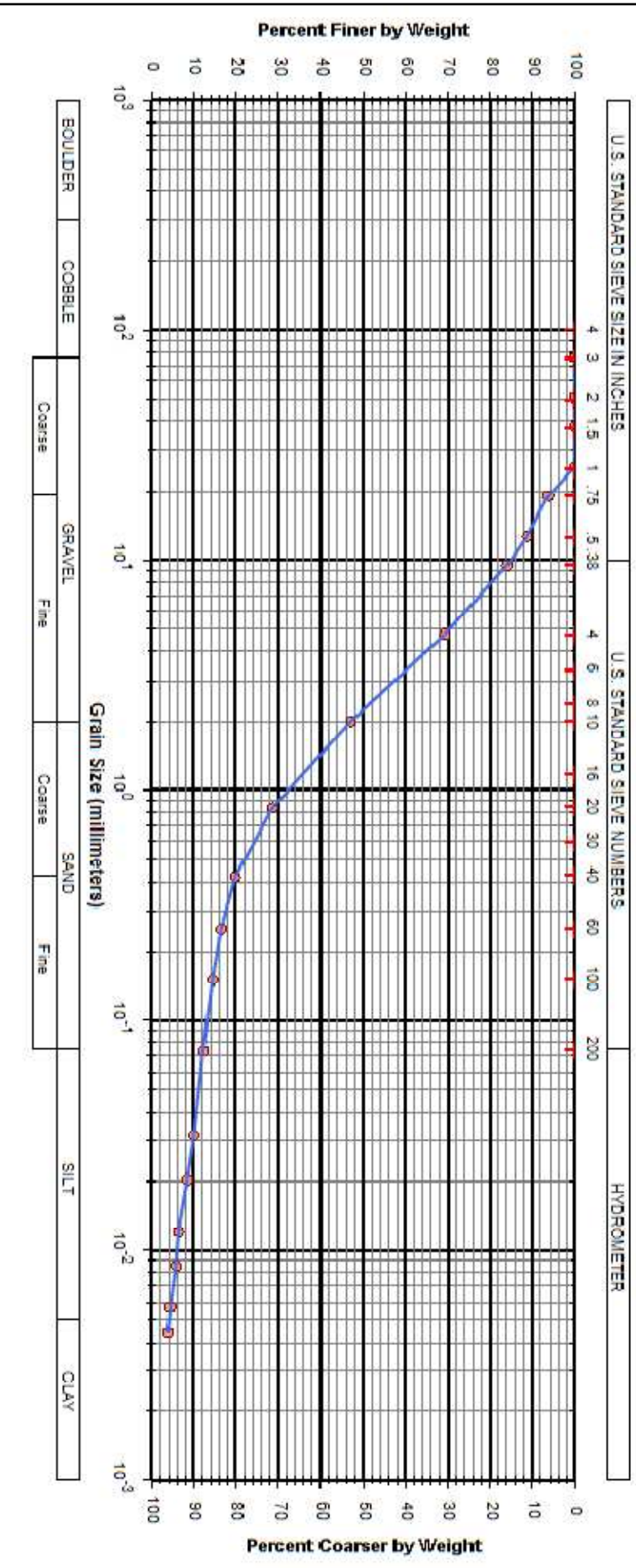



GEOTECHNOLOGY

A Universal Engineering Sciences Company

PARTICLE-SIZE ANALYSIS OF SOILS AASHTO T88

Client:	Stantec Consulting Services, Inc.				Project No.:	J039684.02					
Project:	Laboratory Testing Services, GRE-68-12.65 PID115388, ODOT Dist 7/8 Task Order, Oldtown, OH				Date:	01/17/2024					
Boring No.:	B-002	Sample No.:	S-1 & 2	Depth (ft.):	0.0	Gravel (%)	1.8				
Sample Description:	Silt and Clay				Coarse Sand (%)	7.6	Fine Sand (%)	23.5			
					LL	PL		Silt (%)	41.2	Clay (%)	25.9
							PI	15	Group Index	8	
						WC (%)	A-6a				

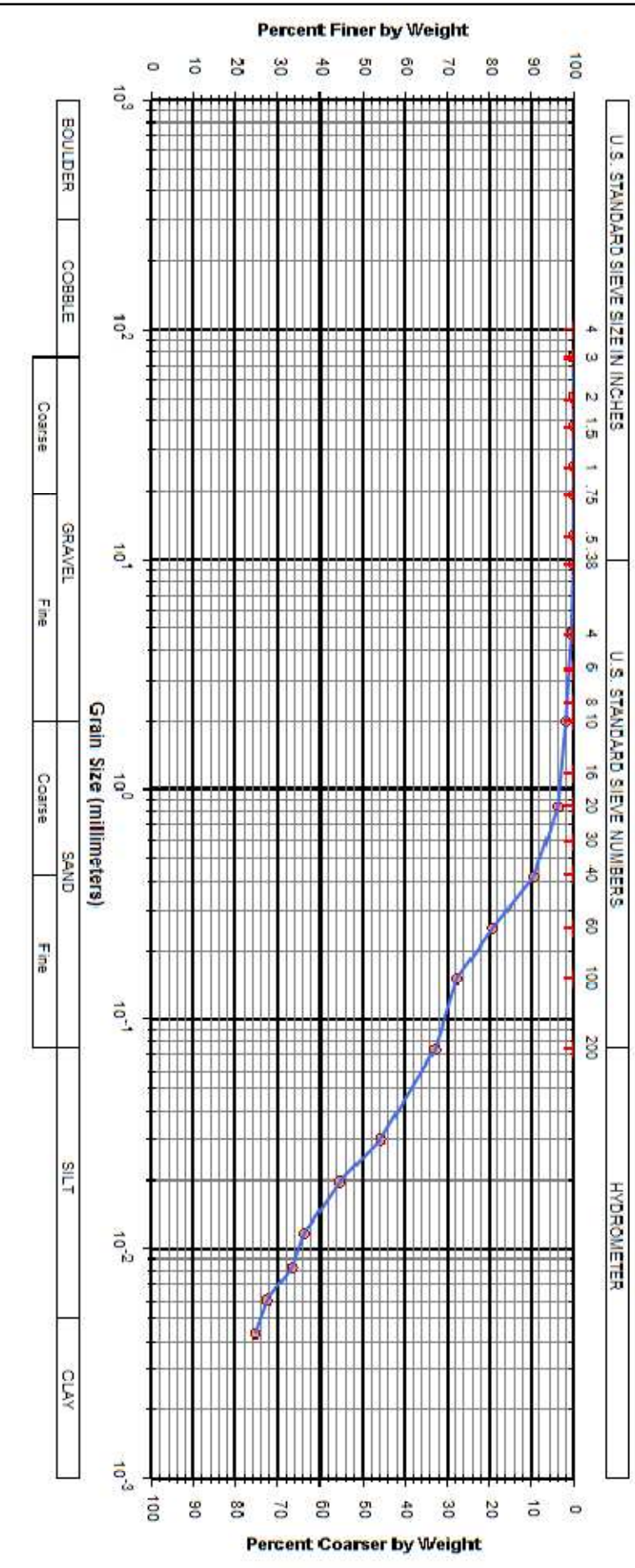



GEO TECHNOLOGY

A Universal Engineering Sciences Company

PARTICLE-SIZE ANALYSIS OF SOILS AASHTO T88

Client:	Stantec Consulting Services, Inc.				Project No.:	J039684.02	
Project:	Laboratory Testing Services, GRE-68-12.65 PID115388, ODOT Dist 7/8 Task Order, Oldtown, OH				Date:	01/17/2024	
Boring No.:	B-002	Sample No.:	ST-3	Depth (ft.):	4.0	ODOT	A-2-4
Sample Description:	Gravel & Stone Frags. with Sand & Silt					Gravel (%)	42.4
						Coarse Sand (%)	19.8
						Fine Sand (%)	9.9
					Silt (%)	17.7	
					Clay (%)	10.2	
					LL	23	
					PL	22	
					PI	1	
					Group Index	0	
					WC (%)	12.8	

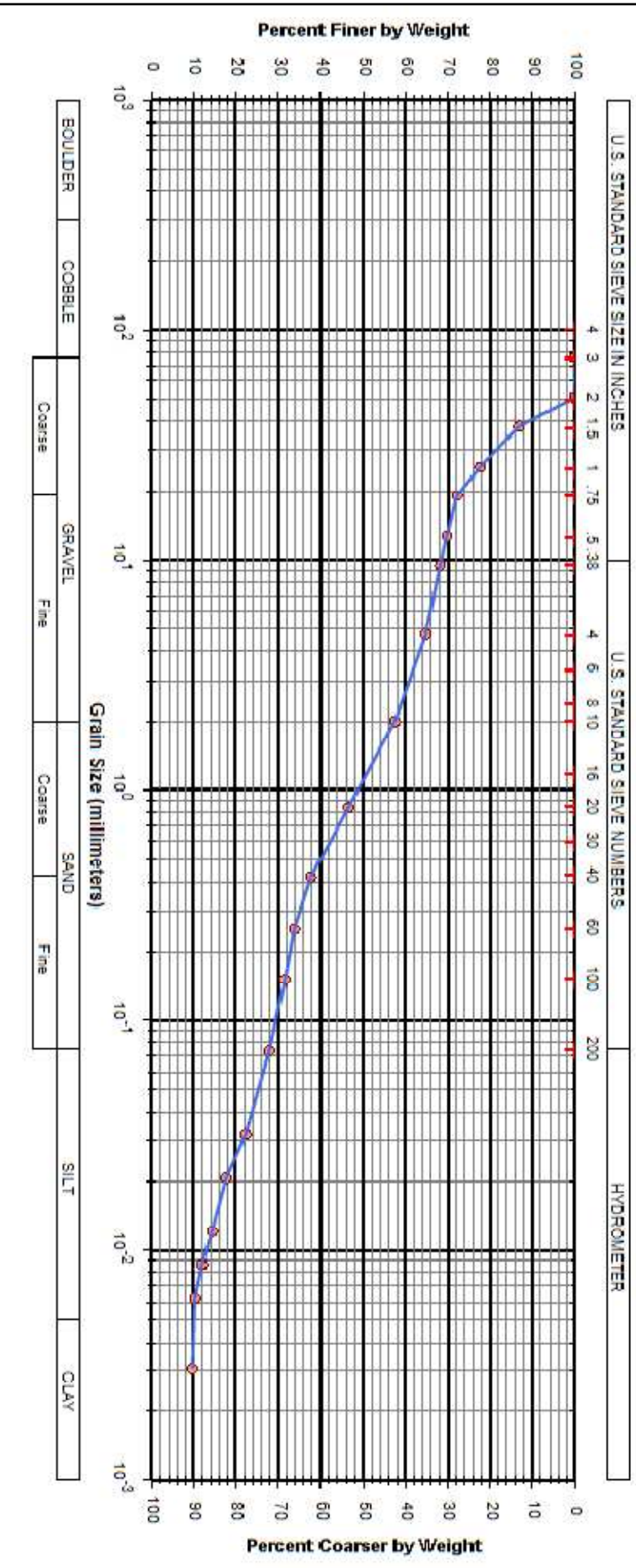



GEOTECHNOLOGY

A Universal Engineering Sciences Company

PARTICLE-SIZE ANALYSIS OF SOILS AASHTO T88

Client:	Stantec Consulting Services, Inc.				Project No.:	J039684.02								
Project:	Laboratory Testing Services, GRE-68-12.65 PID115388, ODOT Dist 7/8 Task Order, Oldtown, OH				Date:	01/17/2024								
Boring No.:	B-002	Sample No.:	S-10 & 11	Depth (ft.):	20.0	ODOT	A-1-a							
Sample Description:	Gravel and Stone Fragments				Gravel (%)	60.9	Coarse Sand (%)	21.9	Fine Sand (%)	6.3	Silt (%)	8.2	Clay (%)	2.7
					LL	18	PL	18	PI		Group Index	0	WC (%)	

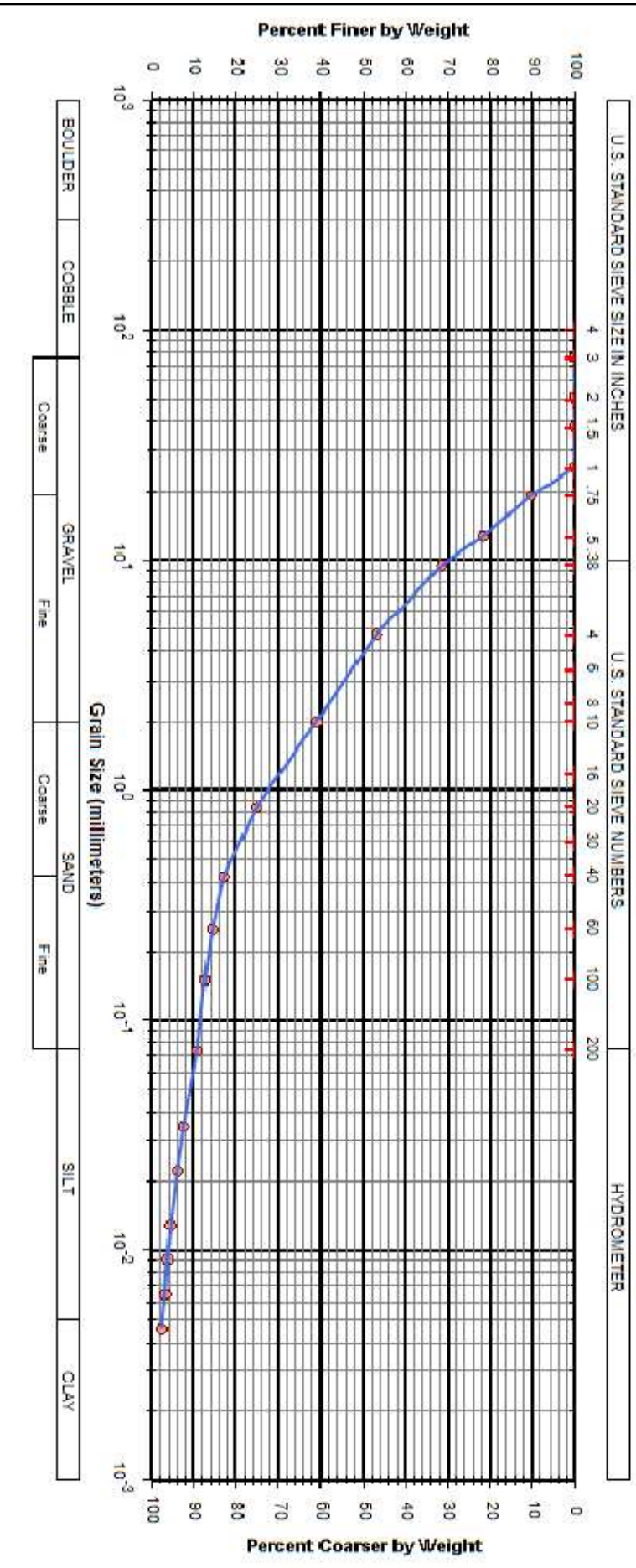



GEO TECHNOLOGY

A Universal Engineering Sciences Company

PARTICLE-SIZE ANALYSIS OF SOILS AASHTO T88

Client:		Stantec Consulting Services, Inc.					Project No.:	J039684.02	
Project:		Laboratory Testing Services, GRE-68-12.65 PID115388, ODOT Dist 7/8 Task Order, Oldtown, OH					Date:	01/17/2024	
Boring No.:	B-002	Sample No.:	S-13 & 14	Depth (ft.):	30.0	Gravel (%)	10.2		
						Coarse Sand (%)	21.4		
						Fine Sand (%)	22.0		
						Silt (%)	20.4		
						Clay (%)	26.0		
Sample Description:				Sandy Silt				LL	21
								PL	13
								PI	8
						Group Index	2		
						WC (%)			

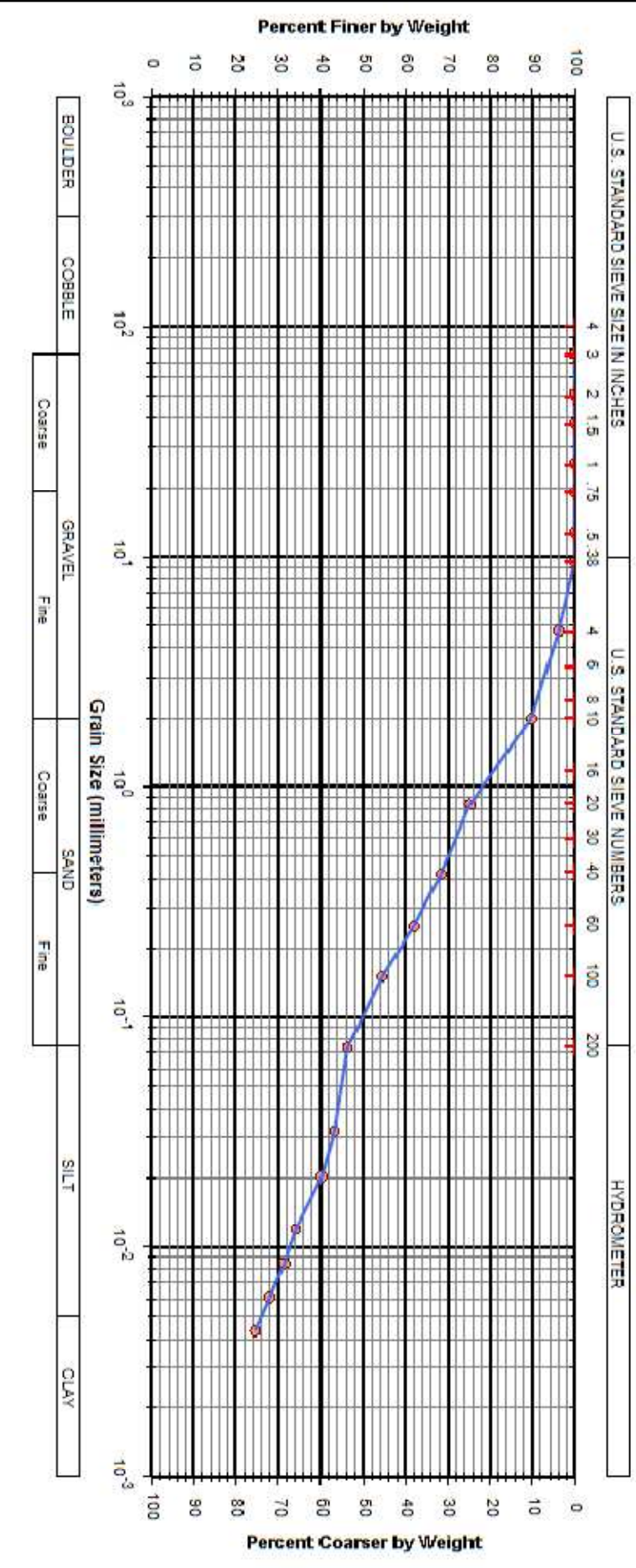



GEOTECHNOLOGY

A Universal Engineering Sciences Company

PARTICLE-SIZE ANALYSIS OF SOILS AASHTO T88

Client:	Stantec Consulting Services, Inc.					Project No.:	J039684.02										
Project:	Laboratory Testing Services, GRE-68-12.65 PID115388, ODOT Dist 7/8 Task Order, Oldtown, OH					Date:	01/17/2024										
Boring No.:	B-002	Sample No.:	S-15 & 16	Depth (ft.):	40.0	Gravel (%)	0.9	Coarse Sand (%)	1.1	Fine Sand (%)	31.5	Silt (%)	59.8	Clay (%)	6.7	ODOT	A-4b
Sample Description:	Silt																
																	LL

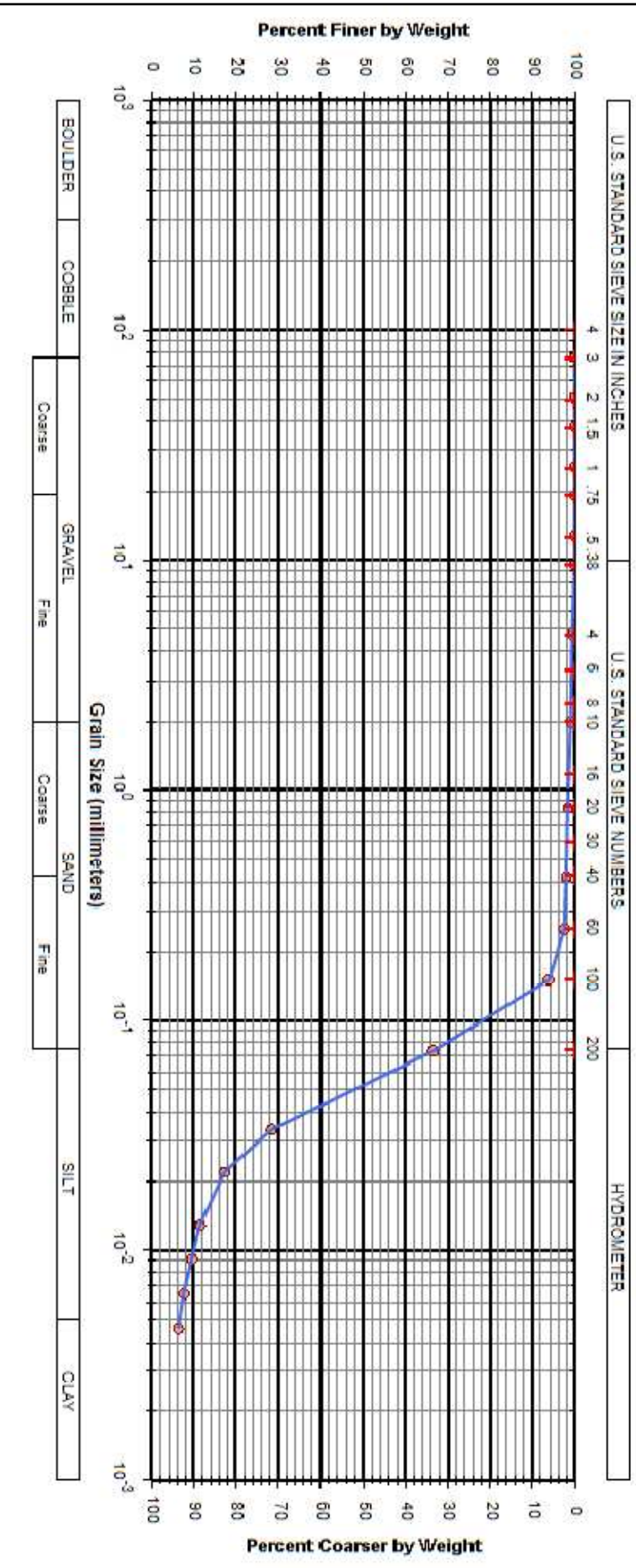



GEOTECHNOLOGY

A Universal Engineering Sciences Company

PARTICLE-SIZE ANALYSIS OF SOILS AASHTO T88

Client:	Stantec Consulting Services, Inc.				Project No.:	J039684.02				
Project:	Laboratory Testing Services, GRE-68-12.65 PID115388, ODOT Dist 7/8 Task Order, Oldtown, OH				Date:	01/17/2024				
Boring No.:	B-001	Sample No.:	ST-2	Depth (ft.):	2.0	Gravel (%)	0.2			
Sample Description:	Silty Clay				Coarse Sand (%)	4.8	Fine Sand (%)	16.5		
					LL	33		PL	17	
					PI	16		Group Index	10	
						Silt (%)	40.6			
						Clay (%)	37.9			
						WC (%)	A-6b			
							19.1			

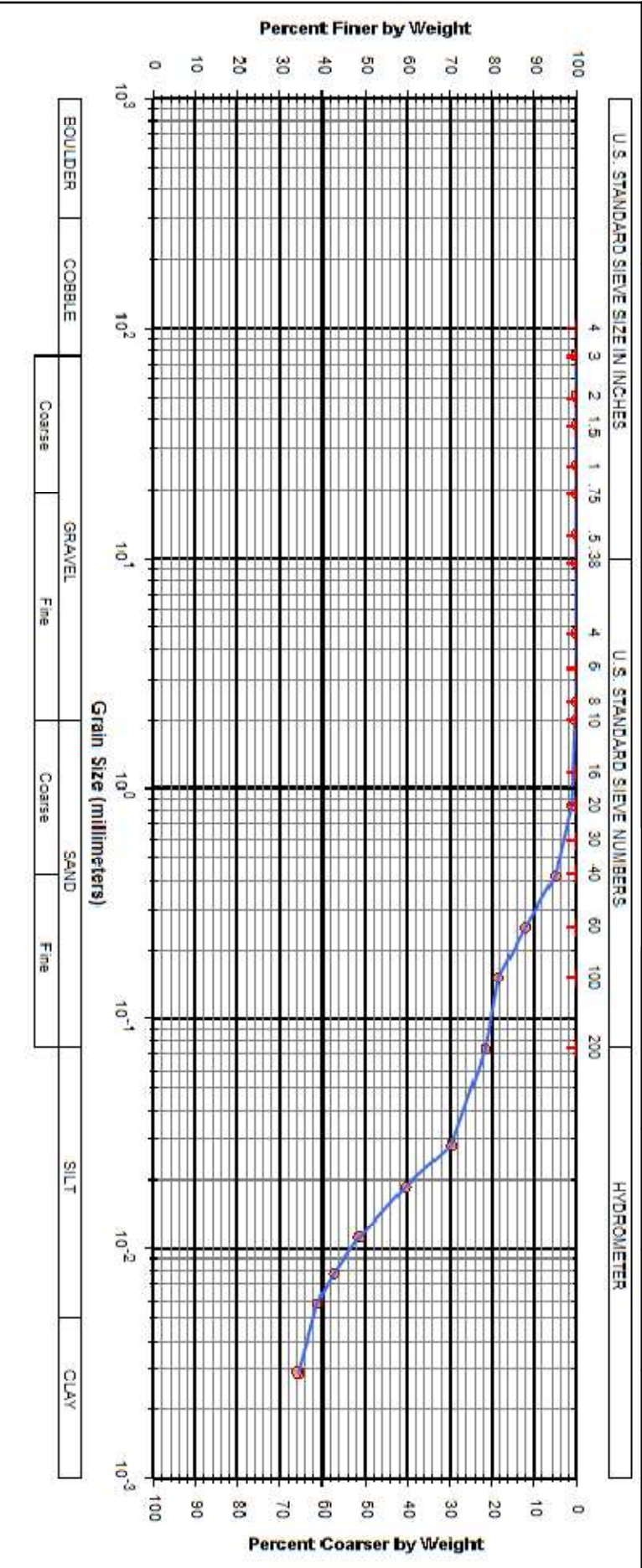



GEOTECHNOLOGY

A Universal Engineering Sciences Company

PARTICLE-SIZE ANALYSIS OF SOILS AASHTO T88

Client:	Stantec Consulting Services, Inc.				Project No.:	J039684.02		
Project:	Laboratory Testing Services, GRE-68-12.65 PID115388, ODOT Dist 7/8 Task Order, Oldtown, OH				Date:	01/17/2024		
Boring No.:	B-004	Sample No.:	S-2 & 3	Depth (ft.):	2.5	Gravel (%)	1.9	
Sample Description:				Clay	Coarse Sand (%)	3.9	LL	52
					Fine Sand (%)	11.9	PL	28
					Silt (%)	39.2	PI	24
					Clay (%)	43.1	Group Index	16
					WC (%)			

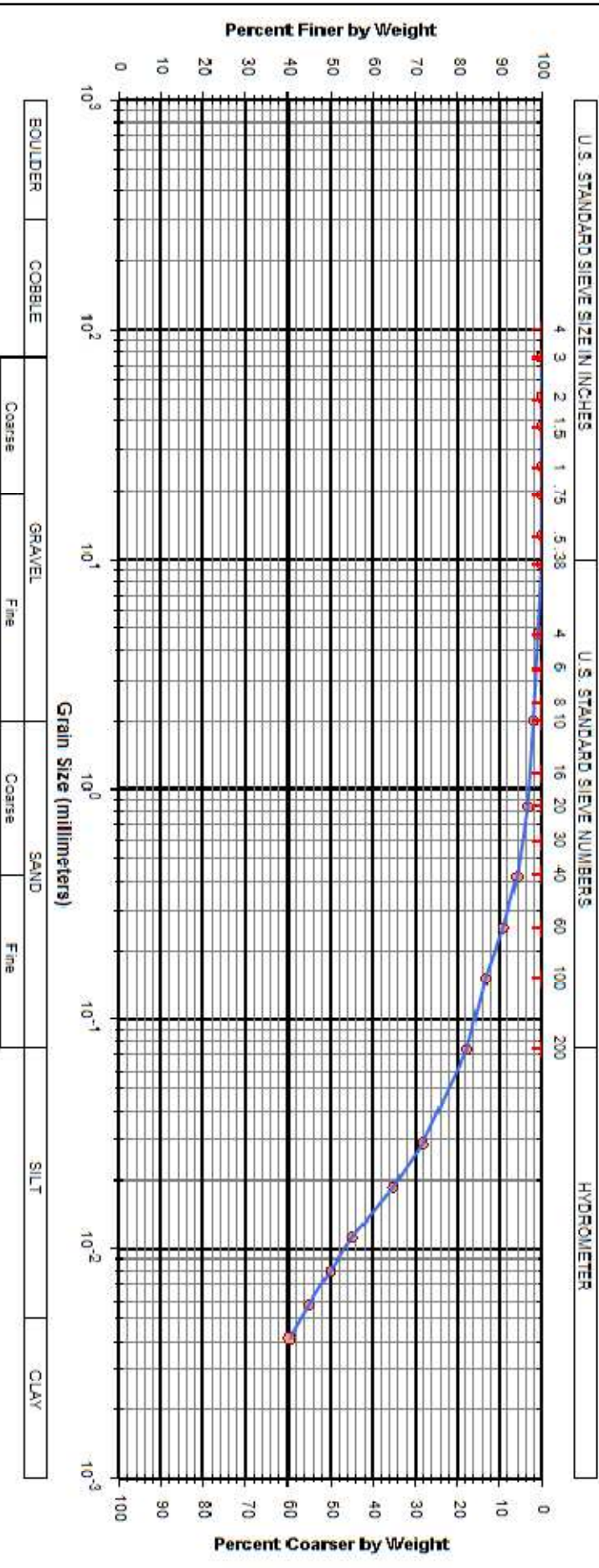



GEOTECHNOLOGY

A Universal Engineering Sciences Company

PARTICLE-SIZE ANALYSIS OF SOILS AASHTO T88

Client:	Stantec Consulting Services, Inc.				Project No.:	J039684.02	
Project:	Laboratory Testing Services, GRE-68-12.65 PID115388, ODOT Dist 7/8 Task Order, Oldtown, OH				Date:	01/17/2024	
Boring No.:	B-004	Sample No.:	S-7 & 8	Depth (ft.):	13.0	ODOT	A-1-b
Sample Description:	Gravel and Stone Fragments with Sand					Gravel (%)	49.9
						Coarse Sand (%)	21.0
						Fine Sand (%)	13.3
					Silt (%)	8.8	
					Clay (%)	7.0	
					PI	16	
					LL	18	
					Group Index	0	
					WC (%)		

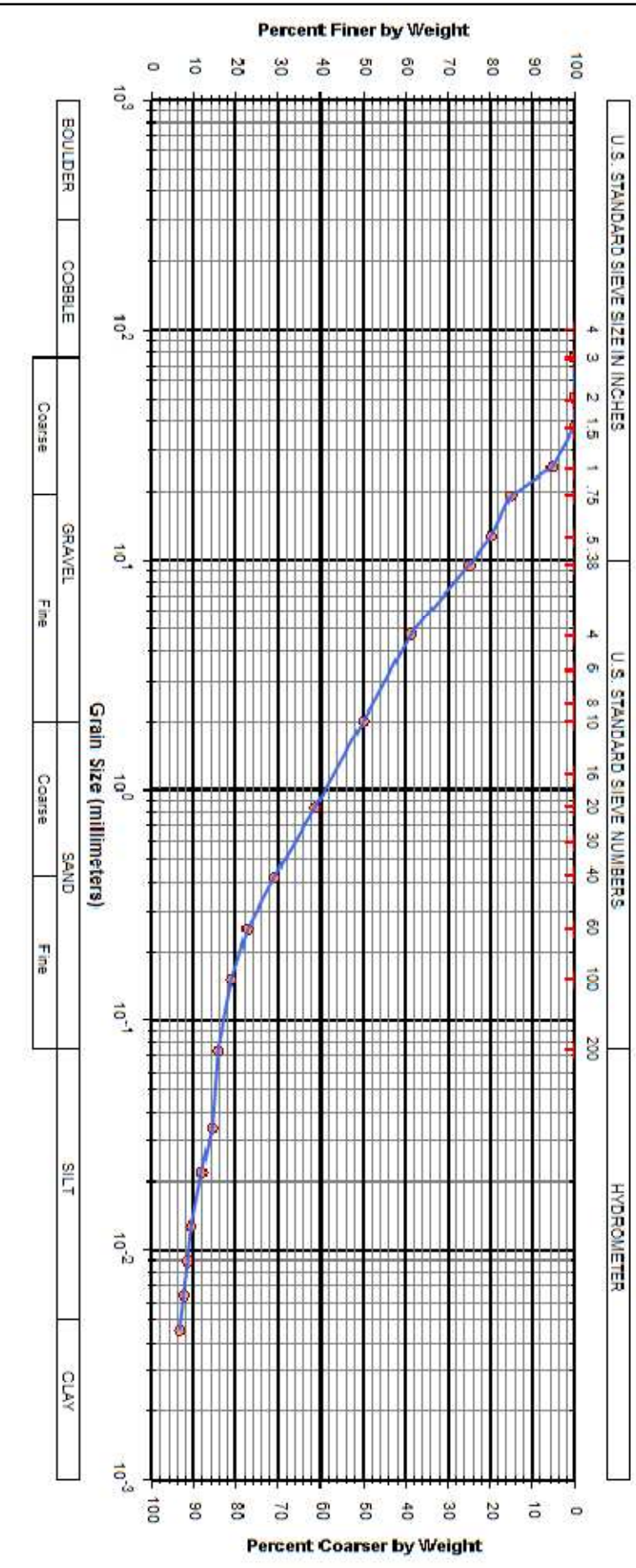



GEOTECHNOLOGY

A Universal Engineering Sciences Company

PARTICLE-SIZE ANALYSIS OF SOILS AASHTO T88

Client:	Stantec Consulting Services, Inc.				Project No.:	J039684.02					
Project:	Laboratory Testing Services, GRE-68-12.65 PID115388, ODOT Dist 7/8 Task Order, Oldtown, OH				Date:	01/17/2024					
Boring No.:	B-004	Sample No.:	S-9 & 10	Depth (ft.):	16.0	ODOT					
Sample Description:	Gravel and Stone Fragments					Gravel (%)	50.0				
						Coarse Sand (%)	23.2				
						Fine Sand (%)	12.9				
						LL	PL	Silt (%)	7.5	Clay (%)	6.4
						17	16	PI	1	Group Index	0
						WC (%)					

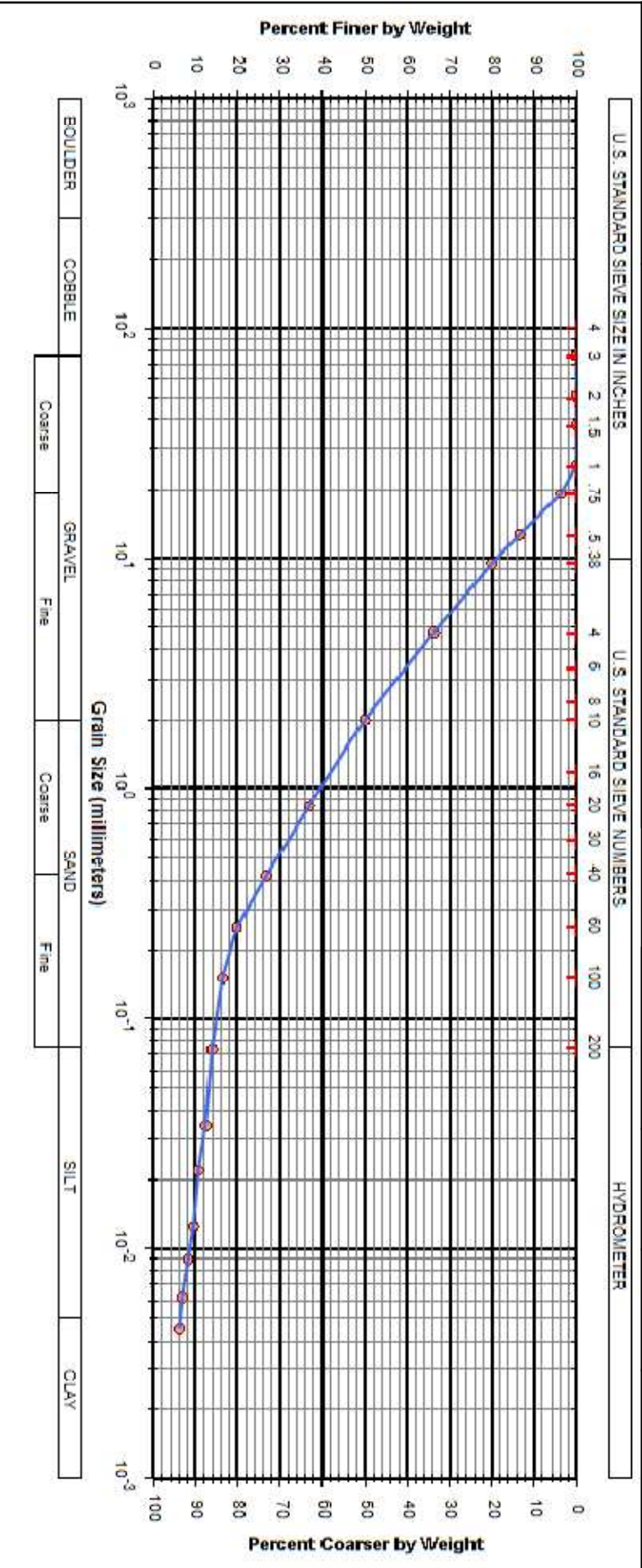



GEOTECHNOLOGY

A Universal Engineering Sciences Company

PARTICLE-SIZE ANALYSIS OF SOILS AASHTO T88

Client:	Stantec Consulting Services, Inc.				Project No.:	J039684.02								
Project:	Laboratory Testing Services, GRE-68-12.65 PID115388, ODOT Dist 7/8 Task Order, Oldtown, OH				Date:	01/17/2024								
Boring No.:	B-004	Sample No.:	S-13 & 14	Depth (ft.):	25.0	ODOT	A-1-a							
Sample Description:	Gravel and Stone Fragments				Gravel (%)	68.7	Coarse Sand (%)	14.3	Fine Sand (%)	6.6	Silt (%)	8.0	Clay (%)	2.4
					LL	18	PL	17	PI	1	Group Index	0	WC (%)	

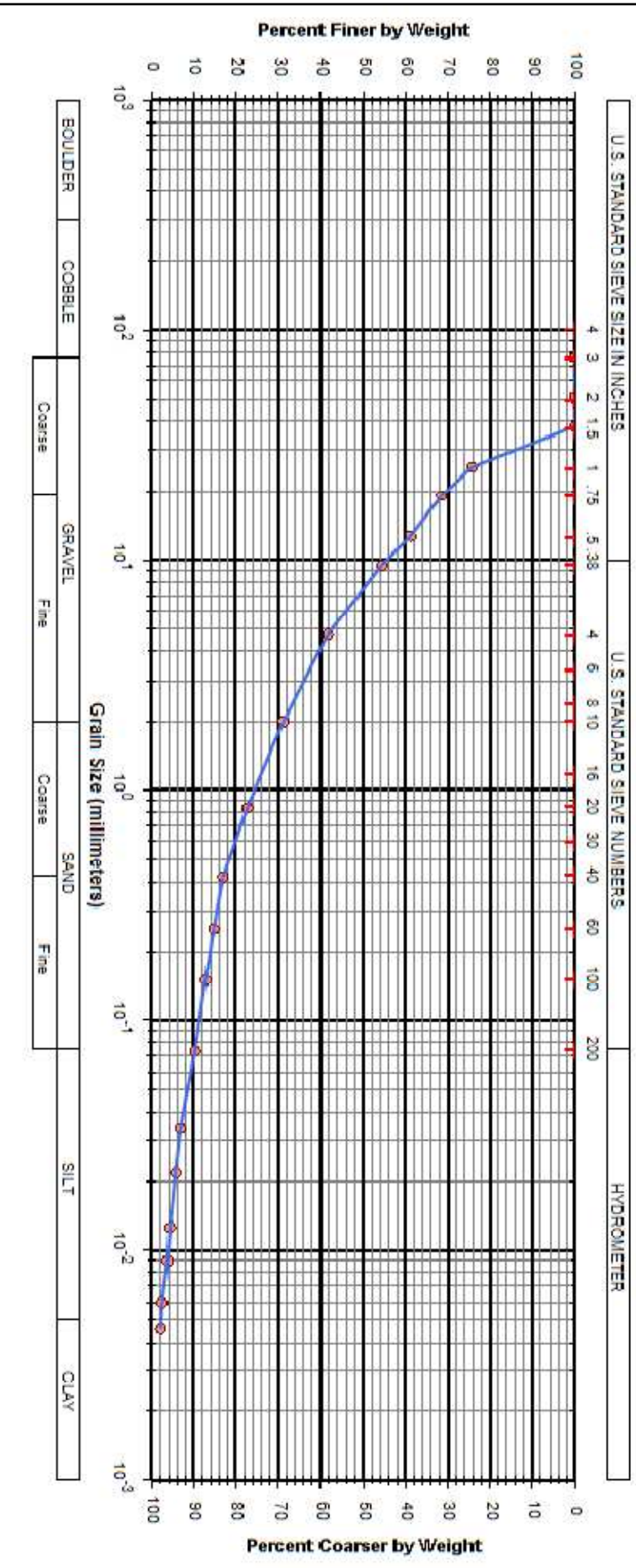



GEO TECHNOLOGY

A Universal Engineering Sciences Company

PARTICLE-SIZE ANALYSIS OF SOILS AASHTO T88

Client:	Stantec Consulting Services, Inc.				Project No.:	J039684.02				
Project:	Laboratory Testing Services, GRE-68-12.65 PID115388, ODOT Dist 7/8 Task Order, Oldtown, OH				Date:	01/17/2024				
Boring No.:	B-003	Sample No.:	S-4 & 5	Depth (ft.):	7.5	Gravel (%)	51.9			
Sample Description:	Gravel and Stone Fragments with Sand				Sand (%)	26.3	Silt (%)	21.8		
					LL	21	PL	21	PI	0
					Group Index		0		AASHTO	A-1-b

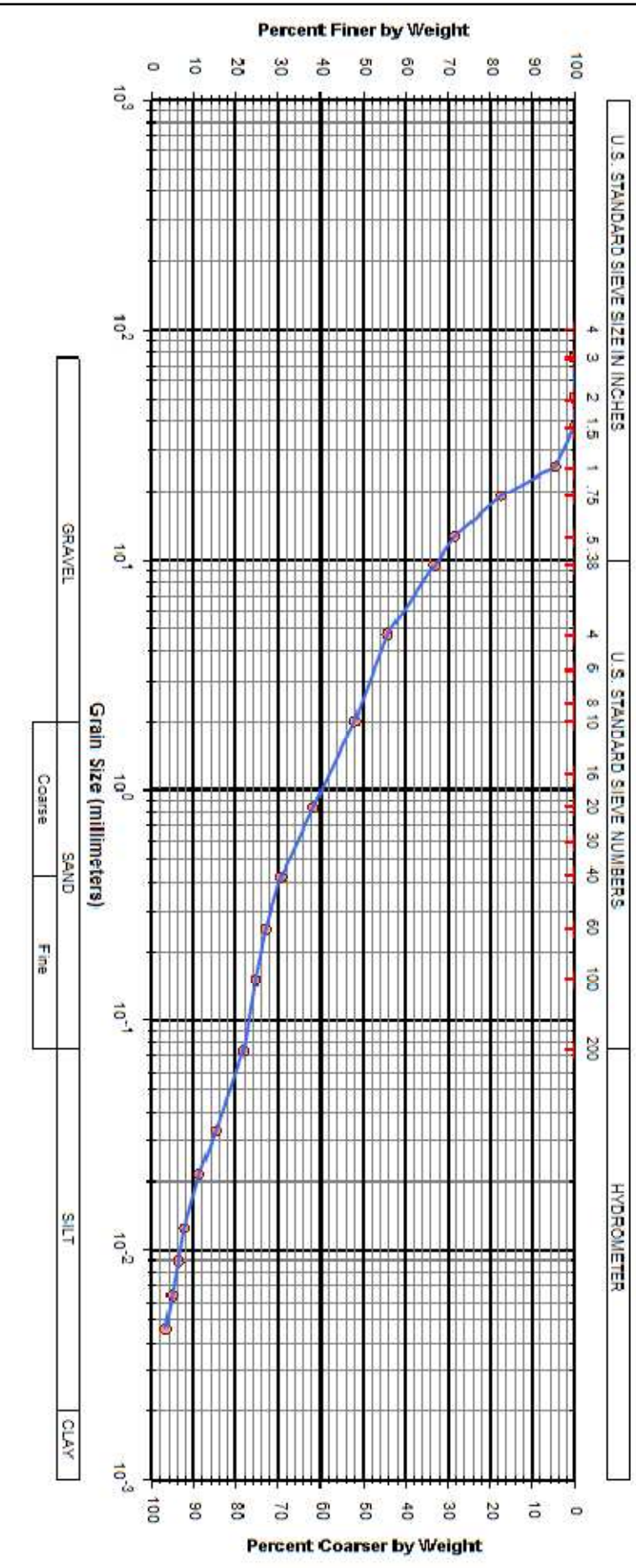



GEO TECHNOLOGY

A Universal Engineering Sciences Company

PARTICLE-SIZE ANALYSIS OF SOILS AASHTO T88

Client: Stantec Consulting Services, Inc.				Project No.: J039684.02			
Project: Laboratory Testing Services, GRE-68-12.65 PID115388, ODOT Dist 7/8 Task Order, Oldtown, OH				Date: 01/17/2024			
Boring No.:	Sample No.:	Depth (ft.):	Gravel (%)	Coarse Sand (%)	Fine Sand (%)	Silt (%)	Clay (%)
B-003	S-6 & 7	10.5	47.2	16.7	12.7	16.0	7.4
Sample Description: Gravel and Stone Fragments with Sand			LL	PL		PI	Group Index
			18	17		1	
			WC (%)		A-1-b		

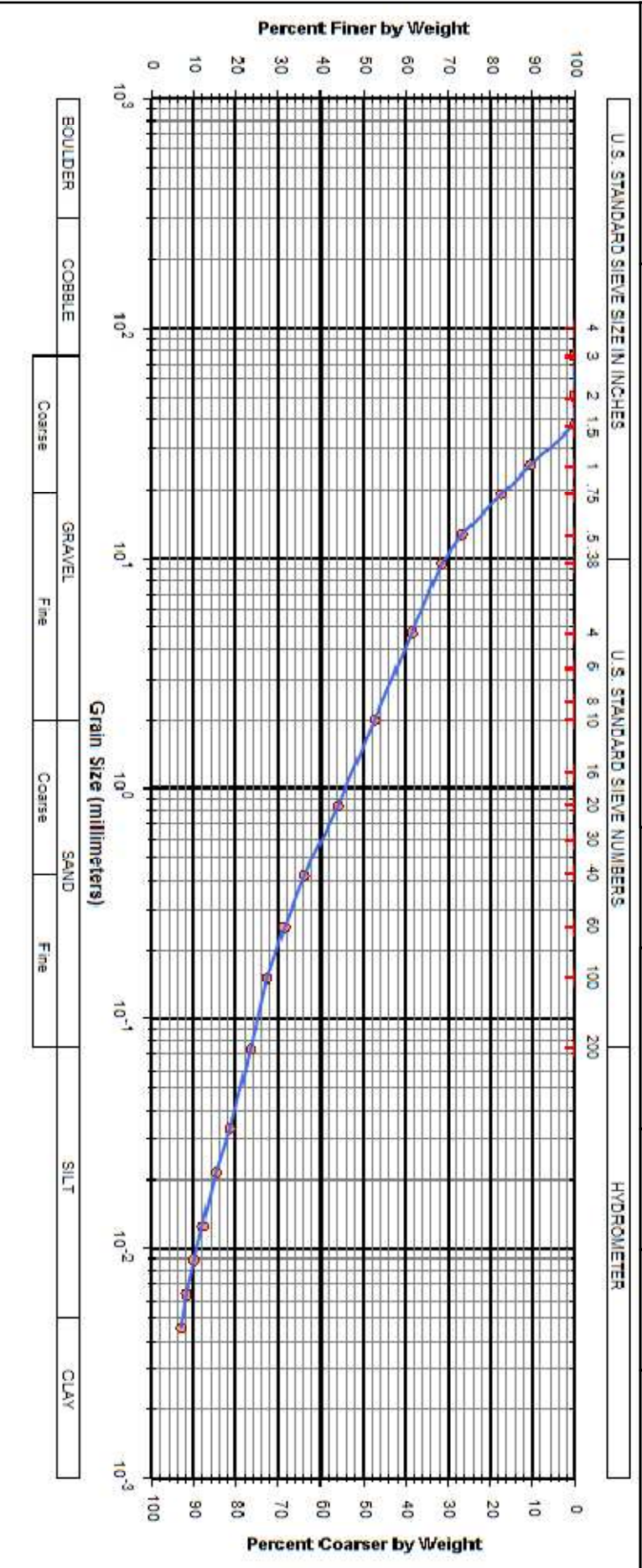



GEOTECHNOLOGY

A Universal Engineering Sciences Company

PARTICLE-SIZE ANALYSIS OF SOILS AASHTO T88

Client:	Stantec Consulting Services, Inc.					Project No.:	J039684.02					
Project:	Laboratory Testing Services, GRE-68-12.65 PID115388, ODOT Dist 7/8 Task Order, Oldtown, OH					Date:	01/17/2024					
Boring No.:	B-003	Sample No.:	S-10 & 11	Depth (ft.):	20.0	Gravel (%)	9.4					
Sample Description:	Sandy Silt						Coarse Sand (%)	11.4				
							LL	20.9	PL	32.3	Silt (%)	26.0
							22	15	7	5	Clay (%)	A-4a
						PI	7					
						Group Index	5					
						WC (%)						

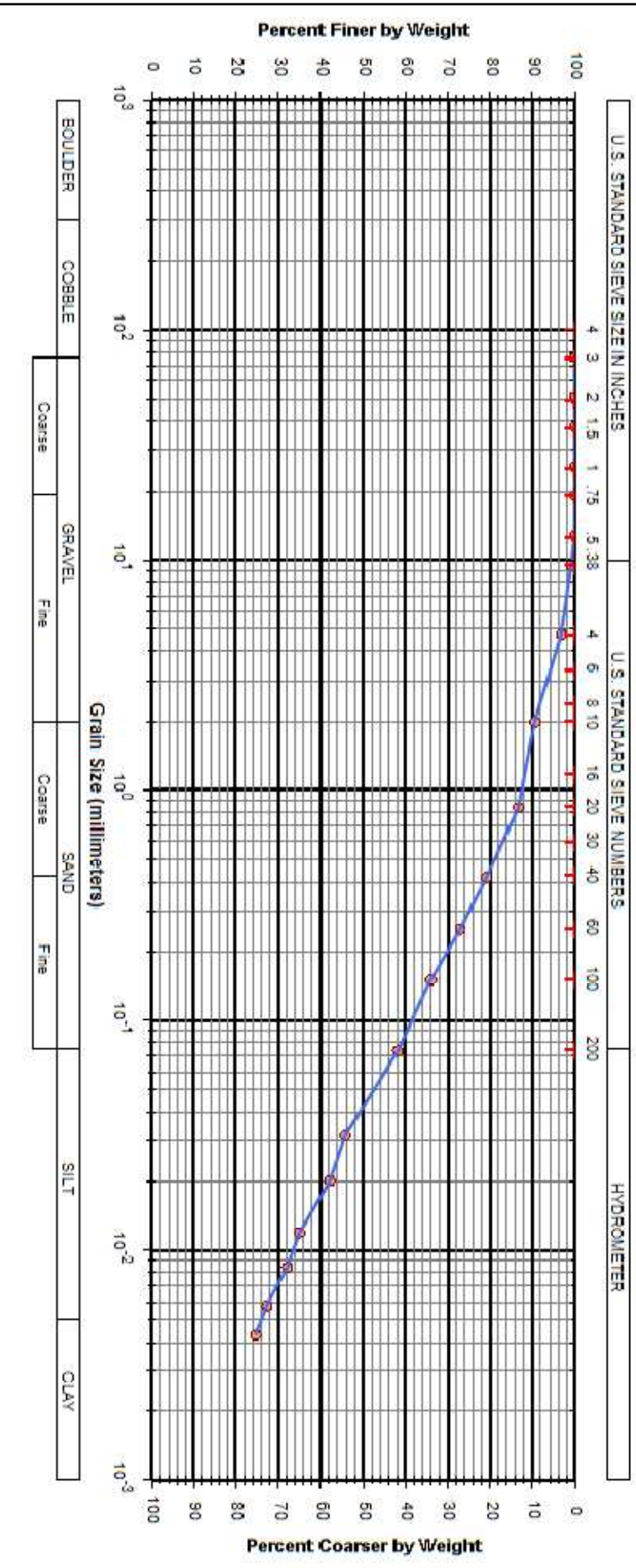



GEOTECHNOLOGY

A Universal Engineering Sciences Company

PARTICLE-SIZE ANALYSIS OF SOILS AASHTO T88

Client: Stantec Consulting Services, Inc.				Project No.: J039684.02			
Project: Laboratory Testing Services, GRE-68-12.65 PID115388, ODOT Dist 7/8 Task Order, Oldtown, OH				Date: 01/17/2024			
Boring No.:	Sample No.:	Depth (ft.):	Gravel (%)	Coarse Sand (%)	Fine Sand (%)	Silt (%)	Clay (%)
B-003	S-16 & 17	45.0	5.5	10.9	22.8	32.7	28.1
Sample Description:				LL	PL	PI	Group Index
Sandy Silt				23	22	1	5
				WC (%)			
				A-4a			

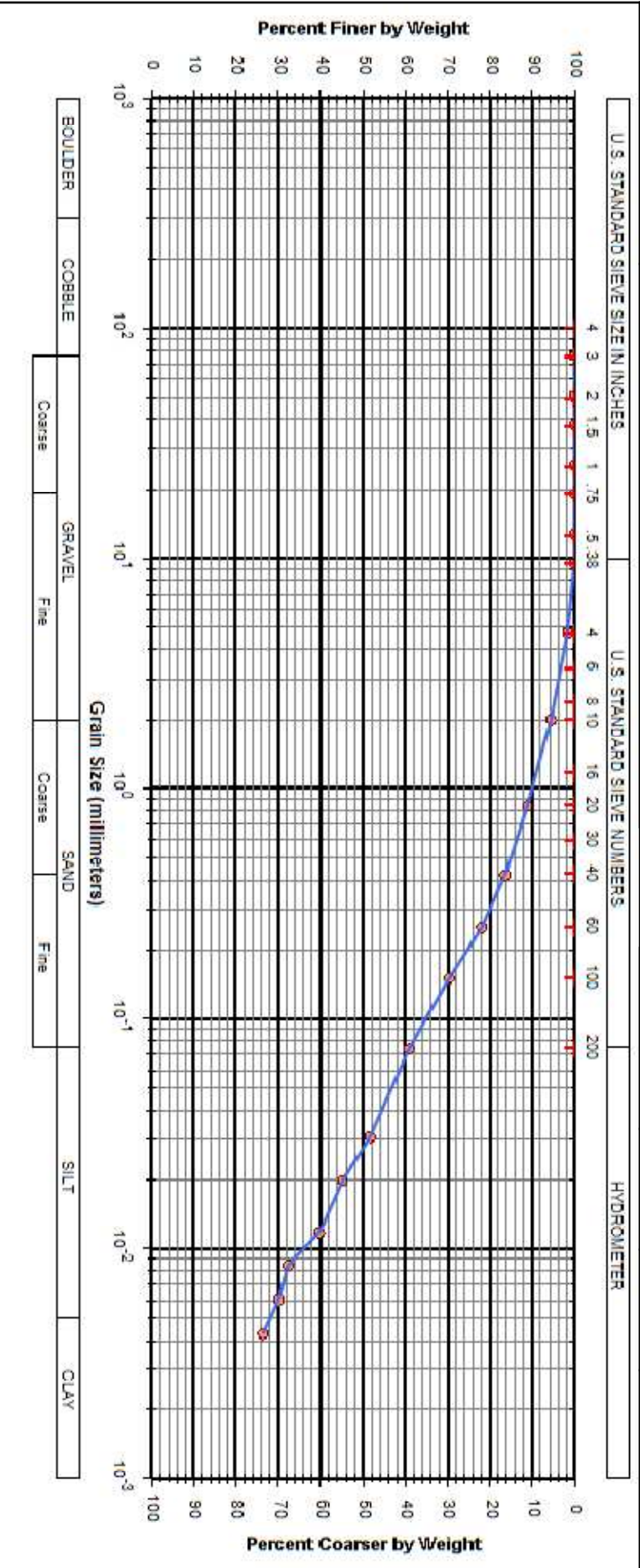

UNCONFINED COMPRESSIVE STRENGTH OF COHESIVE SOILS AASHTO T 208

CLIENT : Stantec Consulting Services, Inc.
 PROJECT NO.: J039684.02
 PROJECT: GRE-68-12.65 PID115388, ODOT Dist 7/8 Task Order
 LOCATION: Oldtown, Ohio

DATE: 1/16/2024

BORING NO.: B-001
 SAMPLE OBTAINED BY: Shelby Tube
 SAMPLE DESCRIPTION: Silty Clay

SAMPLE NO.: ST-2
 CONDITION: Undisturbed

DEPTH (ft.): 2.0-4.0

LIQUID LIMIT (%): 33	PLASTIC LIMIT (%): 17	PLASTICITY INDEX (%): 16	ODOT: A-6b
GRAVEL (%): 0.2	SAND (%): 21.3	SILT (%): 40.6	CLAY (%): 37.9
SPECIFIC GRAVITY OF SOLIDS: 2.75 (Assumed)			LOAD CELL NO.: 1059

SAMPLE DATA	FAILURE DATA
DIAMETER (in.): 2.84	AVERAGE RATE OF AXIAL STRAIN TO FAILURE (%/min.): 1.1
HEIGHT (in.): 5.75	AXIAL STRAIN AT FAILURE (%): 7.8
HEIGHT TO DIAMETER RATIO: 2.02	TIME TO FAILURE (min.): 8.2
WET UNIT WEIGHT (pcf): 131.7	UNCONFINED COMPRESSIVE STRENGTH, q_u (psf): 4,280
DRY UNIT WEIGHT (pcf): 110.6	UNDRAINED SHEAR STRENGTH, s_u (psf): 2,140
VOID RATIO: 0.55	SENSITIVITY, S_r : -
MOISTURE CONTENT (%)*: 19.1	
DEGREE OF SATURATION (%): 95	

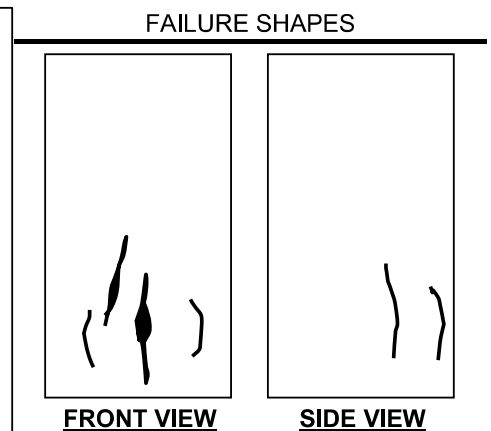
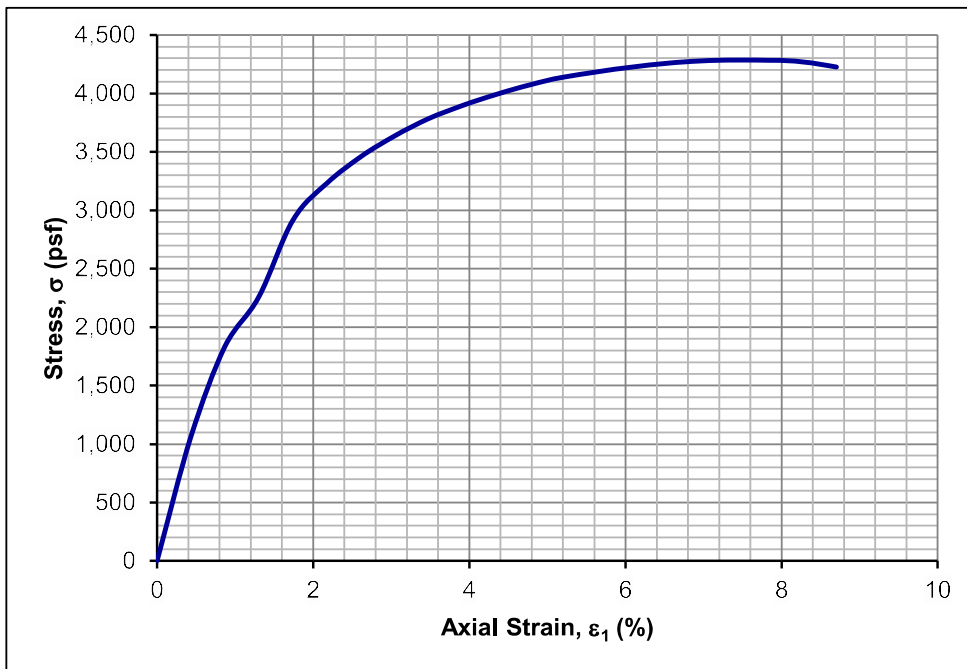

REMARKS :

*Moisture content determined after shear from entire sample.

APPENDIX 1C

SOIL BORING LOGS & LABORATORY TEST RESULTS

PROJECT: GRE-68-12.65 DRILLING FIRM / OPERATOR: UES / TG
 TYPE: STRUCTURE FOUNDATION SAMPLING FIRM / LOGGER: STANTEC / JS
 PID: 115388 SFN: N/A DRILLING METHOD: 3.25" HSA
 START: 1/2/24 END: 1/3/23 SAMPLING METHOD: SPT / ST

DRILL RIG: UES CME 55
 HAMMER: CME AUTOMATIC
 CALIBRATION DATE: 7/17/23
 ENERGY RATIO (%): 90*

STATION / OFFSET: TBD
 ALIGNMENT: US 68
 ELEVATION: 838.0 (MSL) EOB: 51.5 ft.
 LAT / LONG: 39.729686, -83.936960

EXPLORATION ID: B-001-0-23
 PAGE: 1 OF 2

DEPTH (ft)	SPT/ RQD	N ₆₀	REC (%)	SAMPLE ID	HP (tsf)	GRADATION (%)			ATTERBERG			WC	ODOT CLASS (g)	SOLE SEALED	
						GR	CS	FS	SI	CL	LL				PL
837.7	1	2	67	SS-1	1.25	-	-	-	-	-	-	-	18	A-6b (V)	
838.0	2	6	67	SS-1	1.25	-	-	-	-	-	-	-	18	A-6b (V)	
838.0	3	11	83	SS-2	2.00	-	-	-	-	-	-	-	15	A-6b (V)	
838.0	4	4	100	ST-1	4.50	0	4	17	41	38	33	17	16	A-6b (10)	
838.0	5	4	11	SS-2	2.00	-	-	-	-	-	-	-	15	A-6b (V)	
838.0	6	3	4	SS-2	2.00	-	-	-	-	-	-	-	15	A-6b (V)	
838.0	7	4	20	SS-3	-	-	-	-	-	-	-	-	21	A-1-b (V)	
838.0	8	6	7	SS-3	-	-	-	-	-	-	-	-	21	A-1-b (V)	
838.0	9	16	65	SS-4	-	49	22	10	14	5	18	17	1	A-1-b (O)	
838.0	10	18	25	SS-4	-	49	22	10	14	5	18	17	1	A-1-b (O)	
838.0	11	9	11	SS-5	-	49	22	10	14	5	18	17	1	A-1-b (O)	
838.0	12	15	39	SS-5	-	49	22	10	14	5	18	17	1	A-1-b (O)	
838.0	13	11	15	SS-5	-	49	22	10	14	5	18	17	1	A-1-b (O)	
838.0	14	9	39	SS-5	-	49	22	10	14	5	18	17	1	A-1-b (O)	
838.0	15	7	27	SS-6	-	-	-	-	-	-	-	-	4	A-1-b (V)	
838.0	16	8	10	SS-6	-	-	-	-	-	-	-	-	4	A-1-b (V)	
838.0	17	7	27	SS-6	-	-	-	-	-	-	-	-	4	A-1-b (V)	
838.0	18	6	7	SS-7	-	-	-	-	-	-	-	-	6	A-1-b (V)	
838.0	19	6	20	SS-7	-	-	-	-	-	-	-	-	6	A-1-b (V)	
838.0	20	8	11	SS-8	-	-	-	-	-	-	-	-	8	A-1-b (V)	
838.0	21	11	15	SS-8	-	-	-	-	-	-	-	-	8	A-1-b (V)	
838.0	22	8	39	SS-8	-	-	-	-	-	-	-	-	8	A-1-b (V)	
838.0	23	8	11	SS-9	-	-	-	-	-	-	-	-	11	A-1-b (V)	
838.0	24	11	12	SS-9	-	-	-	-	-	-	-	-	11	A-1-b (V)	
838.0	25	8	29	SS-10	-	-	-	-	-	-	-	-	9	A-1-b (V)	
838.0	26	9	10	SS-10	-	-	-	-	-	-	-	-	9	A-1-b (V)	



MEDIUM DENSE TO DENSE, BROWN TO LIGHT GRAY, GRAVEL AND STONE FRAGMENTS WITH SAND, LITTLE SILT, TRACE CLAY, MOIST TO WET

VERY DENSE AT SS-4

DARK BROWN, TOPSOIL, 4 INCHES

MEDIUM STIFF TO STIFF, LIGHT BROWN TO BROWN, SILTY CLAY, SOME SAND, DAMP TO MOIST

QU = 4,280 PSF FROM 2.0 TO 4.0 FT.

ELEV. 838.0

DEPTHS

SPT/ RQD

N₆₀

REC (%)

SAMPLE ID

HP (tsf)

GRADATION (%)

ATTERBERG

WC

ODOT CLASS (g)

SOLE SEALED

PID:	115388	SFN:	N/A	PROJECT:	GRE-68-12.65	STATION / OFFSET:	TBD	START:	1/2/24	END:	1/3/23	PG 2 OF 2	B-001-0-23						
MATERIAL DESCRIPTION AND NOTES		ELEV.	DEPTHS	SPT/ RQD	N ₆₀	REC (%)	SAMPLE ID	HP (tsf)	GR	CS	FS	SI	CL	LL	PL	PI	WC	ODOT CLASS (G)	SEAL
MEDIUM DENSE TO DENSE, BROWN TO LIGHT GRAY, GRAVEL AND STONE FRAGMENTS WITH SAND, LITTLE SILT, TRACE CLAY, MOIST TO WET (continued)		811.5	27																
MEDIUM DENSE TO DENSE, BROWNISH GRAY, GRAVEL AND STONE FRAGMENTS, SOME SAND, TRACE SILT, TRACE CLAY, WET		808.0	28																
			29																
			30	8	42	83	SS-11	-	53	27	8	8	4	18	17	1	12	A-1-a (0)	
			31	15	30	78	SS-12	-	53	27	8	8	4	18	17	1	15	A-1-a (0)	
			32	13															
			33																
			34																
			35	9															
			36	11															
			37																
			38																
			39																
			40	7	36	72	SS-13	-	-	-	-	-	-	-	-	-	11	A-1-a (V)	
			41	15															
			42																
			43																
			44																
			45	7															
			46	50/5"		100	SS-14	-	-	-	-	-	-	-	-	-	12	A-1-a (V)	
			47																
			48																
			49																
			50	13	74	100	SS-15	4.50	-	-	-	-	-	-	-	-			
			51	21															
			51	28															

FOB

HARD, GRAY, SANDY SILT, TRACE TO LITTLE GRAVEL, SOME CLAY, GLACIAL TILL, DAMP

COBBLES ENCOUNTERED FROM 46.0 TO 47.0 FEET

NOTES: GPS COORDINATES DETERMINED BY CELL PHONE. ELEVATION ESTIMATED USING GPS COORDINATES AND GOOGLE EARTH TOPOGRAPHIC DATA.

ABANDONMENT METHODS, MATERIALS, QUANTITIES: BENTONITE, AUGER CUTTINGS MIXED WITH BENTONITE POWDER

**UNCONFINED COMPRESSIVE STRENGTH OF COHESIVE SOILS
AASHTO T 208**

CLIENT : Stantec Consulting Services, Inc.
PROJECT NO.: J039684.02
PROJECT: GRE-68-12.65 PID115388, ODOT Dist 7/8 Task Order
LOCATION: Oldtown, Ohio

DATE: 1/16/2024

BORING NO.: B-001
SAMPLE OBTAINED BY: Shelby Tube
SAMPLE DESCRIPTION: Silty Clay

SAMPLE NO.: ST-2
CONDITION: Undisturbed

DEPTH (ft.): 2.0-4.0

LIQUID LIMIT (%): 33	PLASTIC LIMIT (%): 17	PLASTICITY INDEX (%): 16	ODOT: A-6b
GRAVEL (%): 0.2	SAND (%): 21.3	SILT (%): 40.6	CLAY (%): 37.9
SPECIFIC GRAVITY OF SOLIDS: 2.75 (Assumed)			LOAD CELL NO.: 1059

SAMPLE DATA		FAILURE DATA	
DIAMETER (in.):	2.84	AVERAGE RATE OF AXIAL STRAIN TO FAILURE (%/min.):	1.1
HEIGHT (in.):	5.75	AXIAL STRAIN AT FAILURE (%):	7.8
HEIGHT TO DIAMETER RATIO:	2.02	TIME TO FAILURE (min.):	8.2
WET UNIT WEIGHT (pcf):	131.7	UNCONFINED COMPRESSIVE STRENGTH, q_u (psf):	4,280
DRY UNIT WEIGHT (pcf):	110.6	UNDRAINED SHEAR STRENGTH, s_u (psf):	2,140
VOID RATIO:	0.55	SENSITIVITY, S_r :	-
MOISTURE CONTENT (%)*:	19.1		
DEGREE OF SATURATION (%):	95		

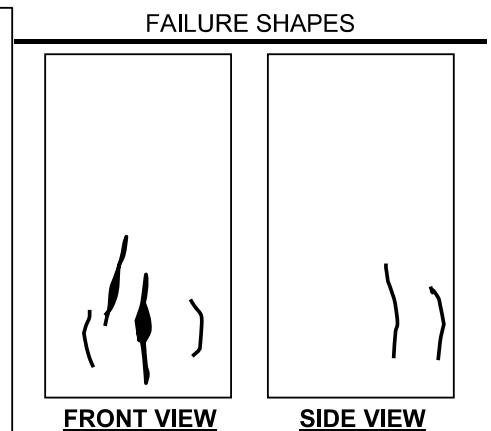
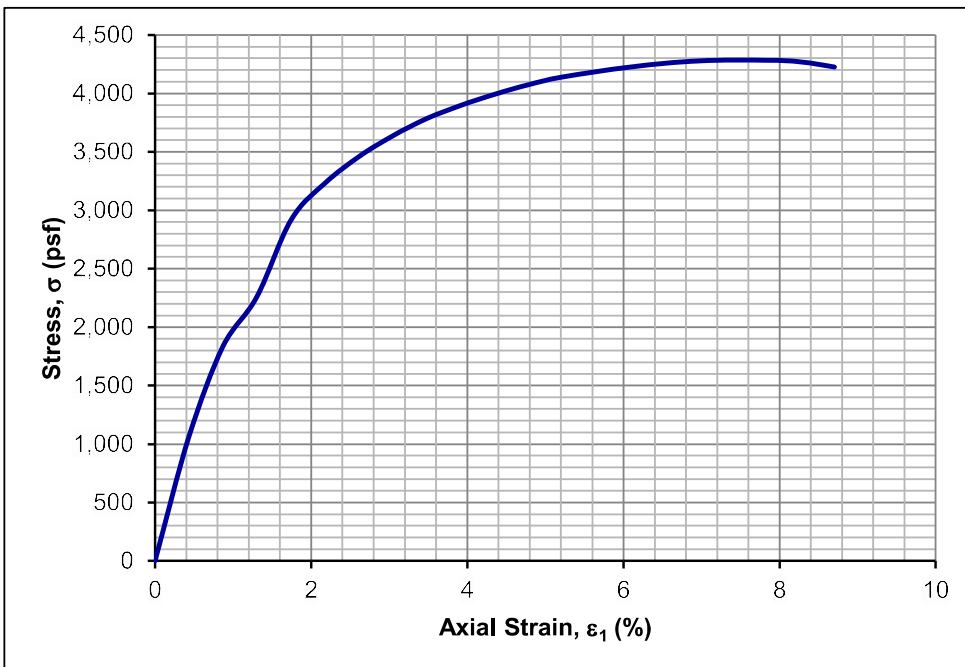

REMARKS :

*Moisture content determined after shear from entire sample.

PROJECT: GRE-68-12.65	DRILLING FIRM / OPERATOR: NEAS INC. / JL	DRILL RIG: CME 55TB	STATION / OFFSET:	EXPLORATION ID: B-001-1-24
TYPE: RETAINING WALL	SAMPLING FIRM / LOGGER: NEAS INC. / JL	HAMMER: CME AUTOMATIC	ALIGNMENT:	
PID: 115388 SFN:	DRILLING METHOD: 3.25" HSA	CALIBRATION DATE: 7/30/24	ELEVATION: 0.0 (MSL)	EOB: 36.5 ft.
START: 11/29/24 END: 11/29/24	SAMPLING METHOD: SPT / ST	ENERGY RATIO (%): 89	COORD: Not Recorded	PAGE 1 OF 2

MATERIAL DESCRIPTION AND NOTES	ELEV.	DEPTHS	SPT/ ROD	N ₆₀	REC (%)	SAMPLE ID	HP (tsf)	GRADUATION (%)						WC	ODOT CLASS (g)	BACK FILL		
								GR	CS	FS	SI	CL	LL				PL	PI
5.0" TOPSOIL (DRILLERS DESCRIPTION)	0.0																	
MEDIUM DENSE, BROWN, GRAVEL WITH SAND AND SILT, TRACE CLAY, MOIST (FILL)	-0.4	1	12	6	22	39	SS-1	-	-	-	-	-	-	-	15	A-2-4 (V)		
BROWN, SILT, LITTLE CLAY, TRACE SAND, TRACE GRAVEL, DAMP (FILL)	-2.3	2		9														
BROWN, SILT, LITTLE CLAY, TRACE SAND, TRACE GRAVEL, DAMP (FILL)	-2.5	3				83	ST-2	4.50	-	-	-	-	-	-	17	A-6a (V)		
HARD, ORANGISH BROWN, SILT AND CLAY, "AND" SAND, TRACE GRAVEL, IRON STAINING, DAMP (FILL)	-4.5	4																
LOOSE, ORANGISH BROWN, COARSE AND FINE SAND, SOME SILT, LITTLE CLAY, TRACE GRAVEL, IRON STAINING, DAMP (FILL)	-7.0	5	3	3	7	61	SS-3	-	-	-	-	-	-	-	11	A-3a (V)		
STIFF TO VERY STIFF, BROWN, SANDY SILT, SOME CLAY, TRACE GRAVEL, MOIST (FILL)	-7.0	6		2														
DENSE, BROWN, GRAVEL WITH SAND, LITTLE SILT, TRACE CLAY, DAMP	-12.0	7	3	4	18	72	SS-4	2.00	3	3	20	44	30	25	16	9	19	A-4a (8)
		8		8														
		9	9	11	37	39	SS-7	-	44	28	11	13	4	NP	NP	NP	6	A-1-b (0)
		10		14														
		11	17	18	58	11	SS-5	1.50	-	-	-	-	-	-	-	-	17	A-4a (V)
		12		21														
		13	7	13	34	56	SS-6	-	-	-	-	-	-	-	-	-	6	A-1-b (V)
		14		10														
		15		9	11	37	SS-7	-	44	28	11	13	4	NP	NP	NP	6	A-1-b (0)
		16		14														
		17		10	12	37	SS-8	-	-	-	-	-	-	-	-	-	8	A-1-b (V)
		18		13														
		19		8	12	45	SS-9	-	-	-	-	-	-	-	-	-	5	A-1-b (V)
		20		18														
		21		9	11	45	SS-10	-	-	-	-	-	-	-	-	-	8	A-1-b (V)
		22		19														
		23		14	30	68	SS-11	-	-	-	-	-	-	-	-	-	11	A-1-b (V)
		24		16														
		25																
		26																
		27																
		28																
		29																

DENSE TO VERY DENSE, BROWN, GRAVEL WITH SAND, TRACE SILT, TRACE CLAY, MOIST TO WET

-22.0

W -22.0

PID: 115388 SFN: PROJECT: GRE-68-12.65 STATION / OFFSET: START: 11/29/24 END: 11/29/24 PG 2 OF 2 B-001-1-24

MATERIAL DESCRIPTION AND NOTES	ELEV.	DEPTHS	SPT/ RQD	N ₆₀	REC (%)	SAMPLE ID	HP (tsf)	GRADATION (%)					ATTERBERG			WC	ODOT CLASS (G)	BACK FILL					
								GR	CS	FS	SI	CL	LL	PL	PI								
DENSE TO VERY DENSE, BROWN, GRAVEL WITH SAND, TRACE SILT, TRACE CLAY, MOIST TO WET (continued)	-30.0	31	4	14	50	83	SS-12	-	23	48	22	5	2	NP	NP	NP	17	A-1-b (0)					
		32		20																			
		33																					
		34																					
		35																					
		36																					
	-36.5	EOB		8	16	49	SS-13	-	17														

NOTES: GROUNDWATER ENCOUNTERED AT 22.0' DURING DRILLING. HOLE DID NOT CAVE. DRILLED AS STAKED.
 ABANDONMENT METHODS, MATERIALS, QUANTITIES: POURED 1.0 BAG HOLE PLUG; SHOVELED SOIL CUTTINGS

PROJECT: GRE-68-12.65		DRILLING FIRM / OPERATOR: NEAS INC. / JL		EXPLORATION ID: B-001-2-24	
TYPE: RETAINING WALL		SAMPLING FIRM / LOGGER: NEAS INC. / JL		ALIGNMENT: _____	
PID: 115388 SFN: _____		DRILLING METHOD: 3.25" HSA		ELEVATION: 0.0 (MSL) EOB: 36.5 ft.	
START: 11/28/24 END: 11/29/24		SAMPLING METHOD: SPT		COORD: _____ Not Recorded	
HARD, BROWN, CLAY, SOME SAND, SOME GRAVEL, LITTLE SILT, CONTAINS ROOTS, MODERATELY ORGANIC, DAMP (FILL)		MATERIAL DESCRIPTION AND NOTES		DRILL RIG: CME 55TB	
DENSE, BROWN, GRAVEL WITH SAND AND SILT, TRACE CLAY, DAMP		ELEV. 0.0		HAMMER: CME AUTOMATIC	
DENSE, BROWN, GRAVEL WITH SAND AND SILT, TRACE CLAY, DAMP		DEPTHS		CALIBRATION DATE: 7/30/24	
DENSE, BROWN, GRAVEL WITH SAND, LITTLE SILT, TRACE CLAY, DAMP		SPT/ RQD		ENERGY RATIO (%): 89	
DENSE, BROWN, GRAVEL WITH SAND, LITTLE SILT, TRACE CLAY, DAMP		N ₆₀		REC SAMPLE ID	
DENSE, BROWN, GRAVEL WITH SAND, LITTLE SILT, TRACE CLAY, DAMP		HP (tsf)		GR (%)	
DENSE, BROWN, GRAVEL WITH SAND, LITTLE SILT, TRACE CLAY, DAMP		GR		CS	
DENSE, BROWN, GRAVEL WITH SAND, LITTLE SILT, TRACE CLAY, DAMP		FS		SI	
DENSE, BROWN, GRAVEL WITH SAND, LITTLE SILT, TRACE CLAY, DAMP		CL		QL	
DENSE, BROWN, GRAVEL WITH SAND, LITTLE SILT, TRACE CLAY, DAMP		LL		PL	
DENSE, BROWN, GRAVEL WITH SAND, LITTLE SILT, TRACE CLAY, DAMP		PI		PI	
DENSE, BROWN, GRAVEL WITH SAND, LITTLE SILT, TRACE CLAY, DAMP		WC		WC	
DENSE, BROWN, GRAVEL WITH SAND, LITTLE SILT, TRACE CLAY, DAMP		ODOT CLASS (g)		ODOT CLASS (g)	
DENSE, BROWN, GRAVEL WITH SAND, LITTLE SILT, TRACE CLAY, DAMP		BACK FILL		BACK FILL	
DENSE, BROWN, GRAVEL WITH SAND, LITTLE SILT, TRACE CLAY, DAMP		-12.0		A-1-b (V)	
DENSE, BROWN, GRAVEL WITH SAND, LITTLE SILT, TRACE CLAY, DAMP		-14.5		A-1-b (V)	
DENSE, BROWN, GRAVEL WITH SAND, LITTLE SILT, TRACE CLAY, DAMP		-22.0		A-1-b (V)	
DENSE, BROWN, GRAVEL WITH SAND, LITTLE SILT, TRACE CLAY, DAMP		-25.0		A-1-a (V)	
DENSE, BROWN, GRAVEL WITH SAND, LITTLE SILT, TRACE CLAY, DAMP		-26.0		A-1-a (V)	
DENSE, BROWN, GRAVEL WITH SAND, LITTLE SILT, TRACE CLAY, DAMP		-27.0		A-1-a (V)	
DENSE, BROWN, GRAVEL WITH SAND, LITTLE SILT, TRACE CLAY, DAMP		-28.0		A-1-a (V)	
DENSE, BROWN, GRAVEL WITH SAND, LITTLE SILT, TRACE CLAY, DAMP		-29.0		A-1-a (V)	

PID: 115388 SFN: PROJECT: GRE-68-12.65 STATION / OFFSET: START: 11/28/24 END: 11/29/24 PG 2 OF 2 B-001-2-24

MATERIAL DESCRIPTION AND NOTES	ELEV.	DEPTHS	SPT/ RQD	N ₆₀	REC (%)	SAMPLE ID	HP (tsf)	GRADATION (%)				ATTERBERG			WC	ODOT CLASS (G)	BACK FILL		
								GR	CS	FS	SI	CL	LL	PL				PI	
DENSE, BROWN, GRAVEL, SOME SAND, TRACE SILT, TRACE CLAY, MOIST TO WET (continued)	-30.0	31	7	16	37	72	SS-11	-	-	-	-	-	-	-	-	13	A-1-a (V)		
		32																	
		33																	
		34																	
		35			10														
		36			14	33	67	SS-12	-	-	-	-	-	-	-	-	11	A-1-a (V)	
		EOB			8														

NOTES: GROUNDWATER ENCOUNTERED AT 25.0' DURING DRILLING. HOLE DID NOT CAVE. DRILLED AS STAKED. ABANDONMENT METHODS, MATERIALS, QUANTITIES: POURED 1.0 BAG HOLE PLUG; SHOVELED SOIL CUTTINGS

PROJECT: GRE-68-12.65 DRILLING FIRM / OPERATOR: NEAS INC. / JL EXPLORATION ID: B-001-3-24
 TYPE: RETAINING WALL SAMPLING FIRM / LOGGER: NEAS INC. / JL
 PID: 115388 SFN: DRILLING METHOD: 3.25" HSA CALIBRATION DATE: 7/30/24 ALIGNMENT: 0.0 (MSL) EOB: 36.5 ft.
 START: 11/27/24 END: 11/27/24 SAMPLING METHOD: SPT / ST ENERGY RATIO (%): 89 COORD: Not Recorded

MATERIAL DESCRIPTION AND NOTES

ELEV. 0.0

DEPTH S

SPT/ROD

N₆₀ REC (%) SAMPLE ID HP (tsf) GR CS FS SI QL LL PL PI WC ODOT CLASS (g)

GRADATION (%) ATTERBERG

BACK FILL

5.0" TOPSOIL (DRILLERS DESCRIPTION)	STIFF TO VERY STIFF, BROWN AND DARK BROWN, CLAY, SOME SILT, LITTLE SAND, TRACE GRAVEL, CONTAINS ROOTS, SLIGHTLY ORGANIC, DAMP (FILL)	-2.8	2	6	44	SS-1	1.50	-	-	-	-	-	-	-	-	-	-	22	A-7.6 (V)	BACK FILL
	MEDIUM DENSE TO DENSE, BROWN, GRAVEL AND STONE FRAGMENTS, SOME SAND, TRACE SILT, TRACE CLAY, DAMP	-14.5	8	18	28	SS-3	-	66	18	5	9	2	NP	NP	NP			4	A-1-a (O)	
		MEDIUM DENSE, BROWN, GRAVEL WITH SAND, TRACE SILT, TRACE CLAY, DAMP	-19.5	11	31	44	SS-4	-	-	-	-	-	-	-	-	-	-	-	4	A-1-a (V)
MEDIUM DENSE, BROWN, COARSE AND FINE SAND, LITTLE GRAVEL, TRACE SILT, TRACE CLAY, DAMP	-28.3	6	21	72	SS-10	-	11	32	44	10	3	NP	NP	NP			6	A-3a (O)		
SS-11 BECOMES WET	-25.0	6	19	67	SS-11	-	-	-	-	-	-	-	-	-	-	-	-	16	A-3a (V)	
DENSE, BROWN, GRAVEL WITH SAND, TRACE SILT, TRACE CLAY, WET	-28.3	7	6																	

PID: 115388 SFN: PROJECT: GRE-68-12.65 STATION / OFFSET: START: 11/27/24 END: 11/27/24 PG 2 OF 2 B-001-3-24

MATERIAL DESCRIPTION AND NOTES	ELEV.	DEPTHS	SPT/ RQD	N ₆₀	REC (%)	SAMPLE ID	HP (tsf)	GRADATION (%)				ATTERBERG			WC	ODOT CLASS (G)	BACK FILL	
								GR	CS	FS	SI	CL	LL	PL				PI
DENSE, BROWN, GRAVEL WITH SAND, TRACE SILT, TRACE CLAY, WET (continued)	-30.0	31	16	42	67	SS-12	-	-	-	-	-	-	-	-	14	A-1-b (V)		
		32	12															
		33																
		34																
		35	9	33	78	SS-13	-	-	-	-	-	-	-	-	10	A-1-b (V)		
		36	13															
	-36.5	EOB																

NOTES: GROUNDWATER ENCOUNTERED AT 25.0' DURING DRILLING. HOLE DID NOT CAVE. DRILLED AS STAKED. ABANDONMENT METHODS, MATERIALS, QUANTITIES: POURED 1.0 BAG HOLE PLUG; SHOVELED SOIL CUTTINGS

Consolidation Test

Project Name: <u>GRE-68-12.65</u>	Prepared by: <u>LR</u>
Source: <u>B-001-3-24 ST-2 (2.6'-2.7'). Offset resampled ST-2</u>	Checked by: <u>ZM</u>
Description: <u>Stiff to very stiff, brown, CLAY, some silt, some sand, little gravel, damp.</u>	Date: <u>12/27/2024</u>

Test Specification: <u>ASTM D 2435</u>	Initial Bulk Unit Weight (lb/ft ³): <u>124</u>
Initial Void Ratio: <u>0.707</u>	Dry Unit Weight (lb/ft ³): <u>99</u>
In-situ Vertical Effective Stress (psf): <u>322</u>	

Compression and Swelling Index

Compression Index (C_c): <u>0.166</u>	Preconsolidation Pressure (σ'_c)(psf): <u>2000</u>
Recompression Index (C_r): <u>0.013</u>	Over-Consolidation Ratio (OCR): <u>6.22</u>

Consolidation Curve

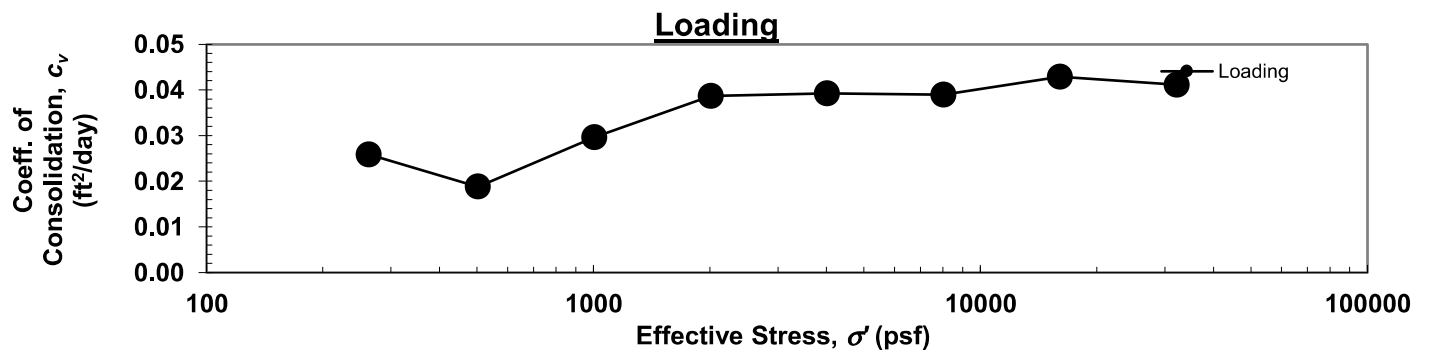
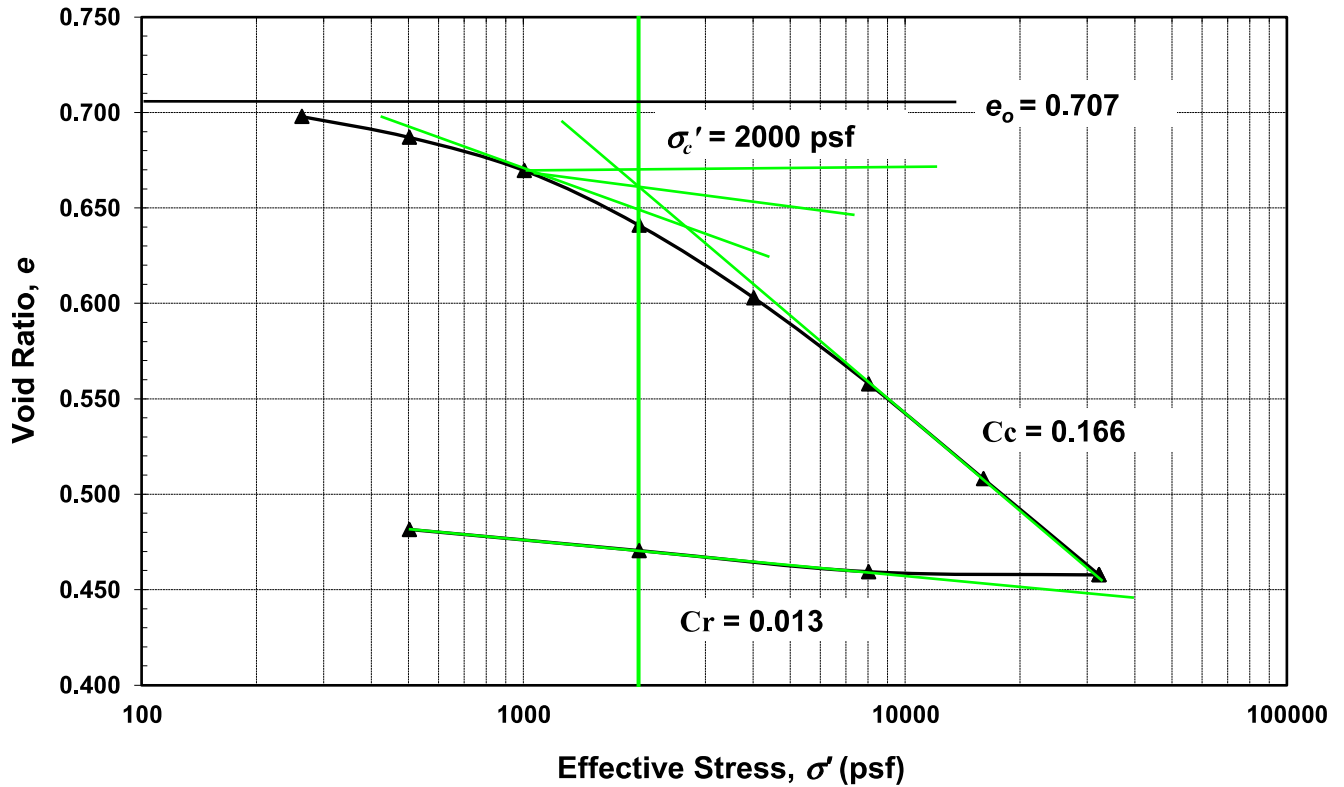

PROJECT: GRE-68-12.65		DRILLING FIRM / OPERATOR: _____		UES / TG		DRILL RIG: _____		UES CME 55		STATION / OFFSET: _____		TBD		EXPLORATION ID							
TYPE: STRUCTURE FOUNDATION		SAMPLING FIRM / LOGGER: _____		STANTEC / JS		HAMMER: _____		CME AUTOMATIC		ALIGNMENT: _____		US 68		B-002-0-23							
PID: 115388 SFN: N/A		DRILLING METHOD: _____		3.25" HSA		CALIBRATION DATE: 7/17/23		ELEVATION: 835.0 (MSL)		EOB: 51.5 ft.		PAGE		1 OF 2							
START: 1/3/23		END: 1/3/23		SPT / ST		ENERGY RATIO (%): 90*		LAT / LONG: 39.729607, -83.936608													
MATERIAL DESCRIPTION AND NOTES		ELEV.		DEPTHS		SPT/ RQD		REC SAMPLE ID		HP (tsf)		GRADATION (%)		ATTERBERG		WC		ODOT CLASS (g)		SOLE SEALED	
GRAY GRAVEL, 2 INCHES		835.0		3		3		SS-1		1.25		1 8 24 41 26		35 20 15		25		A-6a (8)		✓	
STIFF, LIGHT BROWN TO BROWN, SILT AND CLAY, TRACE GRAVEL, SOME SAND, DAMP TO MOIST		834.8		3		3		SS-1		1.25		1 8 24 41 26		35 20 15		25		A-6a (8)		✓	
MEDIUM DENSE TO DENSE, LIGHT BROWN TO GRAY, GRAVEL AND STONE FRAGMENTS WITH SAND AND SILT, TRACE TO LITTLE CLAY, MOIST		831.0		3		3		SS-1		1.25		1 8 24 41 26		35 20 15		25		A-6a (8)		✓	
MEDIUM DENSE TO DENSE, GRAY, GRAVEL AND STONE FRAGMENTS, SOME SAND, TRACE SILT, TRACE CLAY, MOIST TO WET		818.0		3		3		SS-1		1.25		1 8 24 41 26		35 20 15		25		A-6a (8)		✓	
VERY DENSE AT SS-8				4		4		SS-2		2.75		1 8 24 41 26		35 20 15		20		A-6a (8)		✓	
				5		5		SS-3		-		-		-		3		A-24 (V)		✓	
				6		6		SS-4		-		-		-		7		A-24 (V)		✓	
				7		7		SS-5		-		-		-		4		A-24 (V)		✓	
				8		8		SS-6		-		-		-		5		A-24 (V)		✓	
				9		9		SS-7		-		-		-		8		A-24 (V)		✓	
				10		10		SS-8		-		-		-		5		A-1-a (V)		✓	
				11		11		SS-9		-		-		-		12		A-1-a (0)		✓	
				12		12		SS-10		-		-		-		16		A-1-a (0)		✓	
				13		13		SS-11		-		-		-		13		A-1-a (V)		✓	
				14		14		SS-11		-		-		-		13		A-1-a (V)		✓	
				15		15		SS-11		-		-		-		13		A-1-a (V)		✓	
				16		16		SS-11		-		-		-		13		A-1-a (V)		✓	
				17		17		SS-11		-		-		-		13		A-1-a (V)		✓	
				18		18		SS-11		-		-		-		13		A-1-a (V)		✓	
				19		19		SS-11		-		-		-		13		A-1-a (V)		✓	
				20		20		SS-11		-		-		-		13		A-1-a (V)		✓	
				21		21		SS-11		-		-		-		13		A-1-a (V)		✓	
				22		22		SS-11		-		-		-		13		A-1-a (V)		✓	
				23		23		SS-11		-		-		-		13		A-1-a (V)		✓	
				24		24		SS-11		-		-		-		13		A-1-a (V)		✓	
				25		25		SS-11		-		-		-		13		A-1-a (V)		✓	
				26		26		SS-11		-		-		-		13		A-1-a (V)		✓	

PID: 115388		SFN: N/A		PROJECT: GRE-68-12.65		STATION / OFFSET: TBD		START: 1/3/23		END: 1/3/23		PG 2 OF 2		B-002-0-23										
MATERIAL DESCRIPTION AND NOTES				ELEV.	DEPTHS	SPT/ RQD	N ₆₀	REC (%)	SAMPLE ID	HP (tsf)	GRADATION (%)			ATTERBERG	WC	ODOT CLASS (G)	SOLE SEALED							
MEDIUM DENSE TO DENSE, GRAY, GRAVEL AND STONE FRAGMENTS, SOME SAND, TRACE SILT, TRACE CLAY, MOIST TO WET (continued)				808.5	27						GR	CS	FS	SI	CL	LL	PL	PI						
HARD, GRAY, SANDY SILT, LITTLE GRAVEL, SOME CLAY, GLACIAL TILL, DAMP				805.0	28																			
					29																			
HARD, GRAY, SILT, SOME SAND, TRACE CLAY, GLACIAL TILL, MOIST TO WET				795.0	30	19	99	100	SS-12	4.50	11	21	22	20	26	21	13	8	9	A-4a (2)				
					31	27	39																	
					32																			
					33																			
					34																			
					35																			
					36	15	30	99	100	SS-13	4.50	11	21	22	20	26	21	13	8	9	A-4a (2)			
					37																			
					38																			
					39																			
					40	8	18	57	100	SS-14	-	0	1	32	60	7	20	20	NP	25	A-4b (6)			
					41		20																	
					42																			
					43																			
					44																			
					45																			
					46	10	19	74	100	SS-15	-	0	1	32	60	7	20	20	NP	17	A-4b (6)			
					47		30																	
					48																			
					49																			
					50																			
					51	9	26	81	100	SS-16	4.50	-	-	-	-	-	-	-	-	-	-	13	A-4b (V)	

NOTES: GPS COORDINATES DETERMINED BY CELL PHONE. ELEVATION ESTIMATED USING GPS COORDINATES AND GOOGLE EARTH TOPOGRAPHIC DATA.
 ABANDONMENT METHODS, MATERIALS, QUANTITIES: BENTONITE, AUGER CUTTINGS MIXED WITH BENTONITE POWDER

PID: 115388		SFN: N/A		PROJECT: GRE-68-12.65		STATION / OFFSET: TBD		START: 1/3/23		END: 1/3/23		PG 2 OF 2		B-003-0-23							
MATERIAL DESCRIPTION AND NOTES				ELEV.	DEPTHS	SPT/ RQD	N ₆₀	REC (%)	SAMPLE ID	HP (tsf)	GRADATION (%)			ATTERBERG	WC	ODOT CLASS (g)	HOLE SEALED				
HARD, GRAY, SANDY SILT, TRACE TO LITTLE GRAVEL, SOME CLAY; GLACIAL TILL, DAMP (continued)				801.5							GR	CS	FS	SI	CL	LL	PL	PI			
					27																
					28																
					29																
					30																
					31	10	18	59	SS-13	4.50	-	-	-	-	-	-	-	-	-	12	A-4a (V)
					32	21	21														
					33																
					34																
					35																
					36	12	20	74	SS-14	4.50	-	-	-	-	-	-	-	-	-	11	A-4a (V)
					37	29	29														
					38																
					39																
					40																
					41	19	44	122	SS-15	4.50	-	-	-	-	-	-	-	-	-	11	A-4a (V)
					42	37	37														
					43																
					44																
					45																
					46	8	14	51	SS-16	4.50	5	11	23	33	28	23	22	1	12	A-4a (5)	
					47	20	20														
					48																
					49																
					50																
					51	9	16	51	SS-17	4.50	5	11	23	33	28	23	22	1	13	A-4a (5)	
						18	18	100													

776.5
-
FOB

NOTES: GPS COORDINATES DETERMINED BY CELL PHONE. ELEVATION ESTIMATED USING GPS COORDINATES AND GOOGLE EARTH TOPOGRAPHIC DATA.
ABANDONMENT METHODS, MATERIALS, QUANTITIES: BENTONITE; AUGER CUTTINGS MIXED WITH BENTONITE POWDER

PROJECT: GRE-68-12.65
 TYPE: SCOUR
 PID: 115388 SFN: DRILLING FIRM / OPERATOR: NEAS INC. / JL
 START: 11/25/24 END: 11/25/24 DRILLING METHOD: 3.25" HSA
 SAMPLING METHOD: SPT

DRILL RIG: CME 55TB
 HAMMER: CME AUTOMATIC
 CALIBRATION DATE: 7/30/24
 ENERGY RATIO (%): 89

STATION / OFFSET: _____
 ALIGNMENT: _____
 ELEVATION: 0.0 (MSL) EOB: 10.0 ft.
 COORD: _____ Not Recorded

EXPLORATION ID: B-003-1-24
 PAGE: 1 OF 1

MATERIAL DESCRIPTION AND NOTES	ELEV.	DEPTH	SPT/ RQD	N ₆₀	REC (%)	SAMPLE ID	HP (tsf)	GRADATION (%)				ATTERBERG			WC	ODOT CLASS (g)	BACK FILL	
								GR	CS	FS	SI	CL	LL	PL				PI
5.0" TOPSOIL (DRILLERS DESCRIPTION)	0.0																	
STIFF, DARK BROWN, SILT AND CLAY, SOME SAND, TRACE GRAVEL, MOIST (FILL)	-0.4	1	3	9	22	SS-1	1.50	2	3	18	53	24	36	22	14	25	A-6a (10)	<LV <L
HARD, BROWN, SILT AND CLAY, "AND" SAND, LITTLE GRAVEL, DAMP (FILL)	-2.5	2	3	3	22	SS-1	1.50	2	3	18	53	24	36	22	14	25	A-6a (10)	<LV <L
STIFF, DARK BROWN, SILT AND CLAY, SOME SAND, TRACE GRAVEL, CONTAINS TRACE COAL FRAGMENTS, DAMP (FILL)	-4.0	3	4	16	33	SS-2	4.50	12	13	25	29	21	35	20	15	14	A-6a (5)	<LV <L
VERY STIFF, BROWN, SANDY SILT, SOME CLAY, TRACE GRAVEL, DAMP	-5.5	4	4	6	44	SS-3	1.50	4	8	20	44	24	36	21	15	21	A-6a (9)	<LV <L
DENSE, BROWN, GRAVEL WITH SAND AND SILT, TRACE CLAY, DAMP	-7.0	5	10	30	44	SS-3	1.50	4	8	20	44	24	36	21	15	21	A-6a (9)	<LV <L
VERY STIFF, BROWN, SANDY SILT, SOME CLAY, TRACE GRAVEL, DAMP	-10.0	6	4	15	22	SS-4	3.00	-	-	-	-	-	-	-	-	18	A-4a (V)	<LV <L
		7	5	18	22	SS-4	3.00	-	-	-	-	-	-	-	-	18	A-4a (V)	<LV <L
		8	14	42	39	SS-5	-	31	19	16	25	9	NP	NP	NP	11	A-2-4 (0)	<LV <L
		9	14	42	39	SS-5	-	31	19	16	25	9	NP	NP	NP	11	A-2-4 (0)	<LV <L
		10	18	40	61	SS-6	-	-	-	-	-	-	-	-	-	9	A-2-4 (V)	<LV <L
		10	14	40	61	SS-6	-	-	-	-	-	-	-	-	-	9	A-2-4 (V)	<LV <L

NOTES: GROUNDWATER NOT ENCOUNTERED DURING DRILLING. HOLE DID NOT CAVE. DRILLED AS STAKED.
 ABANDONMENT METHODS, MATERIALS, QUANTITIES: SHOVELED SOIL CUTTINGS

PROJECT: GRE-68-12.65		DRILLING FIRM / OPERATOR: UES / TG		DRILL RIG: UES CME 55		STATION / OFFSET: TBD		EXPLORATION ID: B-004-0-23																															
TYPE: STRUCTURE FOUNDATION		SAMPLING FIRM / LOGGER: STANTEC / JS		HAMMER: CME AUTOMATIC		ALIGNMENT: US 68		PAGE: 1 OF 2																															
PID: 115388 SFN: N/A		DRILLING METHOD: 3.25" HSA		CALIBRATION DATE: 7/17/23		ELEVATION: 831.0 (MSL)		EOB: 51.5 ft.																															
START: 1/2/24 END: 1/2/24		SAMPLING METHOD: SPT		ENERGY RATIO (%): 90*		LAT / LONG: 39.729494, -83.935199																																	
MATERIAL DESCRIPTION AND NOTES				ELEV.		DEPTHS		SPT/ RQD		REC SAMPLE ID		HP (tsf)		GR		FS		SI		CL		LL		PL		PI		WC		ODOT CLASS (g)		SOLE SEALED							
DARK BROWN, TOPSOIL, 4 INCHES				830.7		3		3		11		100		SS-1		3.00		-		-		-		-		-		-		19		A-7-6 (V)		✓					
STIFF TO VERY STIFF, DARK BROWN TO BROWN, CLAY, TRACE GRAVEL, LITTLE TO SOME SAND, "AND" SILT, DAMP TO MOIST				818.0		4		4		11		56		SS-2		1.50		2		4		12		39		43		52		28		24		27		✓			
DENSE, BROWN TO GRAY, GRAVEL AND STONE FRAGMENTS WITH SAND, TRACE SILT, TRACE CLAY, MOIST TO WET				815.0		5		5		15		56		SS-5		-		2		4		18		48		28		41		23		18		6		A-7-6 (11)		✓	
DENSE TO VERY DENSE, GRAY, GRAVEL AND STONE FRAGMENTS, TRACE SILT, TRACE CLAY, WET						6		6		24		78		SS-4		4.50		-		-		-		-		-		-		-		17		A-7-6 (V)		✓			
						7		8		21		72		SS-3		2.00		2		4		12		39		43		52		28		24		26		A-7-6 (16)		✓	
						8		8		24		78		SS-4		4.50		-		-		-		-		-		-		-		-		-		-		-	
						9		8		24		78		SS-4		4.50		-		-		-		-		-		-		-		-		-		-		-	
						10		5		15		56		SS-5		-		2		4		18		48		28		41		23		18		6		A-7-6 (11)		✓	
						11		6		15		56		SS-5		-		2		4		18		48		28		41		23		18		6		A-7-6 (11)		✓	
						12		2		30		72		SS-6		-		2		4		18		48		28		41		23		18		8		A-7-6 (11)		✓	
						13		9		39		72		SS-7		-		49		22		13		9		7		18		16		2		11		A-1-b (0)		✓	
						14		13		39		72		SS-7		-		49		22		13		9		7		18		16		2		11		A-1-b (0)		✓	
						15		9		38		61		SS-8		-		49		22		13		9		7		18		16		2		12		A-1-b (0)		✓	
						16		13		38		61		SS-8		-		49		22		13		9		7		18		16		2		12		A-1-b (0)		✓	
						17		12		47		100		SS-9		-		50		23		13		8		6		17		16		1		14		A-1-a (0)		✓	
						18		10		45		100		SS-10		-		50		23		13		8		6		17		16		1		12		A-1-a (0)		✓	
						19		16		45		100		SS-10		-		50		23		13		8		6		17		16		1		12		A-1-a (0)		✓	
						20		16		53		100		SS-11		-		-		-		-		-		-		-		-		-		-		-		-	
						21		20		53		100		SS-11		-		-		-		-		-		-		-		-		-		-		-		-	
						22		15		53		100		SS-11		-		-		-		-		-		-		-		-		-		-		-		-	
						23		9		33		67		SS-12		-		-		-		-		-		-		-		-		-		-		-		-	
						24		13		33		67		SS-12		-		-		-		-		-		-		-		-		-		-		-		-	
						25		14		38		100		SS-13		-		69		14		7		8		2		18		17		1		8		A-1-a (0)		✓	
						26		11		38		100		SS-13		-		69		14		7		8		2		18		17		1		8		A-1-a (0)		✓	

PID:	SFN:	N/A	PROJECT:	STATION / OFFSET:	TBD	START:	END:	PG 2 OF 2	B-004-0-23											
MATERIAL DESCRIPTION AND NOTES			ELEV.	DEPTHS	SPT/ ROD	N ₆₀	REC (%)	SAMPLE ID	HP (tsf)	GR	CS	FS	SI	CL	LL	PL	PI	WC	ODOT CLASS (G)	HOLE SEALED
DENSE TO VERY DENSE, GRAY, GRAVEL AND STONE FRAGMENTS, TRACE SILT, TRACE CLAY; WET (continued)			804.5	27																
				28																
HARD, GRAY, SANDY SILT, TRACE TO LITTLE GRAVEL, SOME CLAY, GLACIAL TILL, DAMP			796.0	29																
				30	14	47	72	SS-14	-	69	14	7	8	2	18	17	1		15	A-1-a (0)
VERY DENSE, GRAY, GRAVEL AND STONE FRAGMENTS, TRACE SILT, TRACE CLAY; GLACIAL TILL, WET			795.3	31	17	14														
				32																
HARD, GRAY, SANDY SILT, TRACE TO LITTLE GRAVEL, SOME CLAY, GLACIAL TILL, DAMP			796.0	33																
				34																
HARD, GRAY, SANDY SILT, TRACE TO LITTLE GRAVEL, SOME CLAY, GLACIAL TILL, DAMP			795.3	35	15	25	42	101	100	SS-15	4.50	-	-	-	-	-	-	-	14	A-4a (V)
				36																
HARD, GRAY, SANDY SILT, TRACE TO LITTLE GRAVEL, SOME CLAY, GLACIAL TILL, DAMP			795.3	37																
				38																
HARD, GRAY, SANDY SILT, TRACE TO LITTLE GRAVEL, SOME CLAY, GLACIAL TILL, DAMP			795.3	39																
				40	18	29	50	119	100	SS-16	-	-	-	-	-	-	-	-	-	12
HARD, GRAY, SANDY SILT, TRACE TO LITTLE GRAVEL, SOME CLAY, GLACIAL TILL, DAMP			795.3	41																
				42																
HARD, GRAY, SANDY SILT, TRACE TO LITTLE GRAVEL, SOME CLAY, GLACIAL TILL, DAMP			795.3	43																
				44																
HARD, GRAY, SANDY SILT, TRACE TO LITTLE GRAVEL, SOME CLAY, GLACIAL TILL, DAMP			795.3	45	15	21	22	65	100	SS-17	-	-	-	-	-	-	-	-	11	A-1-a (V)
				46																
HARD, GRAY, SANDY SILT, TRACE TO LITTLE GRAVEL, SOME CLAY, GLACIAL TILL, DAMP			795.3	47																
				48																
HARD, GRAY, SANDY SILT, TRACE TO LITTLE GRAVEL, SOME CLAY, GLACIAL TILL, DAMP			795.3	49																
				50	11	16	26	63	100	SS-18	2.25	-	-	-	-	-	-	-	-	18
HARD, GRAY, SANDY SILT, TRACE TO LITTLE GRAVEL, SOME CLAY, GLACIAL TILL, DAMP			795.3	51																
				52																

NOTES: GPS COORDINATES DETERMINED BY CELL PHONE. ELEVATION ESTIMATED USING GPS COORDINATES AND GOOGLE EARTH TOPOGRAPHIC DATA.
 ABANDONMENT METHODS, MATERIALS, QUANTITIES: BENTONITE, AUGER CUTTINGS MIXED WITH BENTONITE POWDER

SECTION 2

PEDESTRIAN BRIDGE OVER OLDTOWN CREEK AND US-68

SECTION 2: PEDESTRIAN BRIDGE OVER OLDTOWN CREEK AND US-68

TABLE OF CONTENTS

2.1. INTRODUCTION	2
2.1.1. PROPOSED CONSTRUCTION	2
2.2. GEOTECHNICAL FINDINGS	2
2.2.1. SUBSURFACE CONDITIONS	2
2.2.1.1. <i>Overburden Soil</i>	2
2.2.1.2. <i>Groundwater</i>	3
2.2.1.3. <i>Bedrock</i>	3
2.3. ANALYSIS AND RECOMMENDATIONS	3
2.3.1. SOIL PROFILE FOR ANALYSIS	3
2.3.2. PILE FOUNDATION ANALYSIS	5
2.3.3. PILE DRIVABILITY	6
2.3.4. PILE FOUNDATION RECOMMENDATIONS	7
2.3.5. SETTLEMENT AND DOWNDRAG	8

LIST OF TABLES

TABLE 1:	SOIL PROFILE AND ESTIMATED ENGINEERING PROPERTIES - AT BORING B-001-0-23	4
TABLE 2:	SOIL PROFILE AND ESTIMATED ENGINEERING PROPERTIES - AT BORING B-002-0-23	4
TABLE 3:	SOIL PROFILE AND ESTIMATED ENGINEERING PROPERTIES - AT BORING B-002-1-24	4
TABLE 4:	SOIL PROFILE AND ESTIMATED ENGINEERING PROPERTIES - AT BORING B-003-0-23	5
TABLE 5:	SOIL PROFILE AND ESTIMATED ENGINEERING PROPERTIES - AT BORING B-004-0-23	5
TABLE 6:	DEEP FOUNDATION ANALYSIS SUMMARY	6
TABLE 7:	ESTIMATED PILE LENGTHS	8

LIST OF APPENDICES

APPENDIX 2A: GRLWEAP ANALYSIS

2.1. INTRODUCTION

2.1.1. Proposed Construction

It is our understanding that ODOT is planning the addition of a safe access path from the Little Miami Scenic Trail (LMST) to the newly constructed facilities at the Great Council State Park and Shawnee Interpretive Center, located within Oldtown, Ohio. As part of the planned access path, a new pedestrian bridge (Bridge GRE-68-BK80020-00.492) is proposed to direct pedestrian and bike traffic from the LMST, west over Oldtown Creek and US-68, to the existing sidewalk located on the west side of US-68. Based on the preliminary bridge site plan developed by Carpenter Marty Transportation (Carpenter Marty) dated July 8, 2024, the proposed structure will likely consist of a four-span, steel truss bridge with a concrete deck. The proposed structure is planned to be approximately 485 ft in length (abutment to abutment) with a roadway width of 15-ft width (curb to curb) supported on reinforced concrete substructures consisting of a full-height rear abutment, cap-and-column type piers and a stub type forward abutment. The proposed substructures will likely be supported by a driven pile foundation consisting of 12-inch or 14-inch diameter cast-in-place reinforced concrete pipe piles (CIP piles).

2.2. GEOTECHNICAL FINDINGS

The subsurface conditions encountered during NEAS's explorations for the proposed pedestrian bridge site are described in the following subsections and on each boring log presented in Appendix 1B. The boring logs represent NEAS's interpretation of the subsurface conditions encountered at each boring location based on our site observations, field logs, visual review of the soil samples by NEAS's geologist, and laboratory test results. The lines designating the interfaces between various soil strata on the boring logs represent the approximate interface location; the actual transition between strata may be gradual and indistinct. The subsurface soil and groundwater characterizations included herein, including summary test data, are based on the subsurface findings from the geotechnical explorations performed by Stantec as part of the initial phases of the referenced project, the supplementary exploration performed by NEAS, and consideration of the geological history of the site.

2.2.1. Subsurface Conditions

2.2.1.1. Overburden Soil

At the proposed bridge site, two different materials were generally encountered below the existing topsoil or ground surface. In general, the two different overburden materials consisted of either "man-made" fill / potential fill soils or natural glacial till soils. These materials and the general profile are further described below.

Fill / potential fill soils were encountered in each of the borings performed at the bridge site extending to depths ranging from 4.0 ft to 9.5 ft bgs (elevations 821.3 to 831.5 ft amsl). Based on laboratory testing results and a visual review of the samples obtained, the fill at the bridge site is generally comprised of cohesive, fine-grained materials that are classified on the boring logs as either cohesive Silt and Clay (A-6a), Silty Clay (A-6b), or Clay (A-7-6). With respect to the soil strength of the fill soils encountered, these soils can be described as having a consistency of medium stiff to hard correlating to converted SPT-N (N_{60}) values between 6 and 33 blows per foot (bpf) and unconfined compressive strengths (estimated by means of hand penetrometer) between 1.0 and 4.5 tons per square foot (tsf). The natural moisture content of these

Structure Foundation Exploration Report
Bridge GRE-68-BK80020-00.492
GRE-68-12.65
Greene County, Ohio
PID: 115388

soils ranged from 15 to 27 percent. Based on Atterberg Limits tests performed on representative samples of the natural cohesive material, the liquid and plastic limits ranged from 33 to 52 percent and from 17 to 28 percent, respectively.

Naturally deposited glacial till soils were encountered underlying the fill/potential fill soils in each of the borings performed at the bridge site. In general, the till can be divided into an upper and lower stratum based on the characteristics. The upper till stratum generally consisted of coarse- and fine-grained, non-cohesive soils, though relatively thin layers (0.75-ft to 3.5-ft thick) of fine-grained cohesive material were encountered in the upper stratum. The lower till stratum generally consisted of fine-grained, cohesive soils. The natural till material extended to borehole termination depth in each boring with termination depths encountered ranging from 51.5 to 61.5 ft bgs (elevations 766.8 to 786.5 ft amsl). The non-cohesive till encountered at the site classified on the boring logs as Gravel and Stone Fragments (A-1-a), Gravel and Stone Fragments with Sand (A-1-b), Gravel and/or Stone Fragments with Sand and Silt (A-2-4), and non-cohesive Silt (A-4b). This material can be described as having a relative compactness of medium dense to very dense correlating to N_{60} values between 13 bpf and SPT-N refusal (i.e., less than 6 inches of penetration over 50 blows). Natural moisture contents of the non-cohesive till ranged from 3 to 22 percent. The cohesive till encountered at the site is classified on the boring logs as cohesive Sandy Silt (A-4a), cohesive Silt (A-4b), and Clay (A-7-6) which can be described as having a consistency of stiff to hard correlating to N_{60} values between 15 and 131 bpf and unconfined compressive strengths (estimated by means of hand penetrometer) between 2.25 and 4.5 tsf. Natural moisture contents of the cohesive till ranged from 6 to 25 percent. Based on Atterberg Limits tests performed on representative samples of the natural cohesive material, the liquid and plastic limits ranged from 20 to 41 percent and from 12 to 23 percent, respectively

2.2.1.2. Groundwater

Groundwater measurements were taken during the boring drilling procedures and immediately following the completion of each borehole. Groundwater was observed during and/or upon completion of drilling in each of the borings performed as part of the referenced structure foundation exploration with the exception of B-002-1-24. Based on measurements at boring location, groundwater was encountered at depths ranging from 10.5 to 21.0 ft bgs (elevations 814.1 to 817.5 ft amsl).

It should be noted that groundwater is affected by many hydrologic characteristics in the area and may vary from those measured at the time of the exploration. The specific groundwater readings are included on the boring logs located within Appendix 1B.

2.2.1.3. Bedrock

Bedrock was not encountered within the borings performed at the site.

2.3. ANALYSIS AND RECOMMENDATIONS

2.3.1. Soil Profile for Analysis

For deep foundation analyses purposes, each boring drilled for the proposed bridge was reviewed, and a generalized material profile was developed. Utilizing the generalized soil profile, engineering properties for each soil stratum were estimated based on their field (i.e., SPT N Values, etc.) and laboratory test (i.e., Atterberg Limits, grain size, etc.) results using correlations provided in published engineering manuals, research reports and guidance documents. Engineering soil properties were estimated for each individual classified layer per boring location. The developed soil profiles and estimated engineering soil properties

Structure Foundation Exploration Report
Bridge GRE-68-BK80020-00.492
GRE-68-12.65
Greene County, Ohio
PID: 115388

for use in analysis (with cited correlation/reference material) are summarized within Tables 1 through 5 below.

Table 1: Soil Profile and Estimated Engineering Properties - At Boring B-001-0-23

Rear Abutment: Profile for Analysis, B-001-0-23					
Soil Description	Unit Weight (pcf)	Undrained Shear Strength (psf)	Effective Cohesion (psf)	Effective Friction Angle (degrees)	Setup Factor (f_{su})
Silty Clay Depth (832.3 ft - 831.5 ft)	130	2100	205	22	1.75
Gravel with Sand Depth (831.5 ft - 808 ft)	130	-	-	40	1.0
Gravel Depth (808 ft - 788 ft)	130	-	-	39	1.0
Sandy Silt Depth (788 ft - 786.5 ft)	140	8750	525	31	1.5
Notes: 1. Values calculated per Ohio Department of Transportation (ODOT) GDM Section 404/1304 and/or ODOT BDM Table 305-2.					

Table 2: Soil Profile and Estimated Engineering Properties - At Boring B-002-0-23

Pier 1: Profile for Analysis, B-002-0-23					
Soil Description	Unit Weight (pcf)	Undrained Shear Strength (psf)	Effective Cohesion (psf)	Effective Friction Angle (degrees)	Setup Factor (f_{su})
Silt and Clay Depth (835 ft - 831 ft)	130	1500	150	23	1.5
Gravel with Sand and Silt Depth (831 ft - 818 ft)	130	-	-	40	1.2
Gravel Depth (818 ft - 805 ft)	132	-	-	42	1.0
Sandy Silt Depth (805 ft - 795 ft)	140	-	-	45	1.2
Silt Depth (795 ft - 783.5 ft)	140	-	-	38	1.5
Notes: 1. Values calculated per Ohio Department of Transportation (ODOT) GDM Section 404/1304 and/or ODOT BDM Table 305-2.					

Table 3: Soil Profile and Estimated Engineering Properties - At Boring B-002-1-24

Pier 2: Pedestrian Bridge, B-002-1-24					
Soil Description	Unit Weight (pcf)	Undrained Shear Strength (psf)	Effective Cohesion (psf)	Effective Friction Angle (degrees)	Setup Factor (f_{su})
Silty Clay ⁽²⁾ Depth (828.3 ft - 821.3 ft)	125	2500	225	25	1.75
Gravel with Sand and Silt Depth (821.3 ft - 816.3 ft)	125	-	-	35	1.2
Silt Depth (816.3 ft - 813.8 ft)	125	-	-	33	1.5
Gravel with Sand Depth (813.8 ft - 811.3 ft)	135	-	-	43	1.0
Sandy Silt Depth (811.3 ft - 790 ft)	140	9000	535	31	1.5
Sandy Silt Depth (790 ft - 766.8 ft)	135	5900	400	29	1.5
Values calculated per Ohio Department of Transportation (ODOT) GDM Section 404/1304 and/or ODOT BDM Table 305-2.					

Structure Foundation Exploration Report
Bridge GRE-68-BK80020-00.492
GRE-68-12.65
Greene County, Ohio
PID: 115388

Table 4: Soil Profile and Estimated Engineering Properties - At Boring B-003-0-23

Pier 3: Profile for Analysis, B-003-0-23					
Soil Description	Unit Weight (pcf)	Undrained Shear Strength (psf)	Effective Cohesion (psf)	Effective Friction Angle (degrees)	Setup Factor (f_{su})
Silty Clay Depth (828.2 ft - 823 ft)	120	1300	130	23	1.75
Gravel with Sand Depth (823 ft - 819 ft)	125	-	-	36	1.0
Gravel with Sand Depth (819 ft - 808 ft)	135	-	-	45	1.0
Sandy Silt Depth (808 ft - 793.5 ft)	140	7650	480	30	1.5
Sandy Silt Depth (793.5 ft - 776.5 ft)	140	-	-	42	1.2
<i>Values calculated per Ohio Department of Transportation (ODOT) GDM Section 404/1304 and/or ODOT BDM Table 305-2.</i>					

Table 5: Soil Profile and Estimated Engineering Properties - At Boring B-004-0-23

Forward Abutment: Profile for Analysis, B-004-0-23					
Soil Description	Unit Weight (pcf)	Undrained Shear Strength (psf)	Effective Cohesion (psf)	Effective Friction Angle (degrees)	Setup Factor (f_{su})
Clay Depth (831 ft - 818 ft)	122	2300	215	24	2.0
Gravel with Sand Depth (818 ft - 815 ft)	130	-	-	41	1.0
Gravel Depth (815 ft - 796 ft)	130	-	-	42	1.0
Gravel Depth (796 ft - 781 ft)	140	-	-	47	1.0
Sandy Silt Depth (781 ft - 779.5 ft)	140	7450	470	30	1.5
<i>Notes:</i>					
<i>1. Values calculated per Ohio Department of Transportation (ODOT) GDM Section 404/1304 and/or ODOT BDM Table 305-2.</i>					

2.3.2. Pile Foundation Analysis

Based on the determined soil profile and our estimated engineering soil properties, a pile analysis was performed using the computer program GRLWEAP to determine the estimated geotechnical pile length needed to achieve the UBV required to support the design load for a single pile at each substructure (GRLWEAP results included within Appendix 2A). For the purposes of this report and our analysis, the term 'geotechnical pile length' has been assumed to represent the length of pile from bottom of pile cap (assumed pile cap bearing elevation) to the depth at which the required ultimate bearing value (UBV) is obtained. Based on the soil profile encountered at the site, it is our opinion that pile resistances obtained during dynamic testing (driving) may be reduced due to the potential for soil disturbance (development of high pore water pressure) near the pile perimeter. This disturbance could cause piles to potentially drive easily or “run” for extended depths and initial driving resistances may not reach the indicated target UBV utilizing the estimated pile lengths. This reduced-resistance value obtained at the end of driving the estimated pile length is designated as the End of Initial Driving resistance or EOID. If the EOID is significantly different than the required UBV, it may be necessary to let the piles “set up” (reduction of pore water pressure in the soils adjacent to the pile) for an established period of time. To estimate the potential effects of this disturbance during driving, the setup factors presented in Tables 1 through 5 of Section 2.3.1. of this report are used to estimate driving strength losses as well as the side resistance expected to gain following the setup period.

The UBV and EOID values are determined in accordance with Sections 305.3.2.4 and 305.3.5.9 of the ODOT BDM. The UBV is determined by dividing the total factored load for the highest loaded pile at each substructure by the appropriate driven pile resistance factor, while the EOID is determined by subtracting the amount of side resistance expected to gain from soil setup from the UBV value. The amount of side

Structure Foundation Exploration Report
Bridge GRE-68-BK80020-00.492
GRE-68-12.65
Greene County, Ohio
PID: 115388

resistance expected to gain from soil setup is taken as the difference between the side resistance obtained in ultimate (post setup) conditions and the side resistance obtained during driving (dynamic) conditions at the determined geotechnical pile length. It is recommended that the piles for the referenced project be installed according to ODOT's Construction and Material Specifications (CMS) 507 and CMS 523, and therefore, a driven pile resistance factor of 0.7 should be used. For our analysis it is assumed that the proposed pile cap elevations will match those shown in the preliminary GRE-68-12.65, Bridge No. GRE-BK80020-00.492 site plan developed by Carpenter Marty dated July 8, 2024. Bridge design loads are assumed to be consistent with those provided by Carpenter Marty via email on February 4, 2025. While pile sizes are assumed to be consistent with those provided by the design team (Carpenter Marty / Eagle Bridge) via email on February 13, 2025.

The results for our analysis for ultimate and during driving conditions are summarized for the proposed structure in Table 6 below (GRLWEAP results included within Appendix 2A). The referenced table also includes: 1) the required geotechnical pile length in ultimate conditions for a CIP pile driven to the respective UBV per substructure location; 2) the length of driven pile required in driving conditions for a CIP piles driven to the respective UBV per substructure location; and, 3) the estimated difference in pile length between a pile in ultimate and driving conditions.

Table 6: Deep Foundation Analysis Summary

Pile Type	Ultimate Conditions		Driving Conditions		Pile Length Difference Ultimate vs. Driving Conditions (ft)	End of Initial Driving Value ⁽³⁾ (kips)	Setup Factor (f_{su})
	Geotechnical Pile Length ⁽¹⁾ (ft)	Ultimate Bearing Value ⁽²⁾ (kips)	Driven Pile Length ⁽¹⁾ (ft)	Bearing Value During Driving ⁽²⁾⁽⁴⁾ (kips)			
Bridge GRE-68-BK80020-00.492 - Rear Abutment, B-001-0-23							
14-inch CIP	12.5	293	12.5	293	0.0	293	1.0
Bridge GRE-68-BK80020-00.492 - Pier 1, B-002-0-23							
12-inch CIP	13.0	227	13.0	227	0.0	227	1.0
Bridge GRE-68-BK80020-00.492 - Pier 2, B-002-1-24							
14-inch CIP	20.6	303	23.8	303	3.2	231	1.3
Bridge GRE-68-BK80020-00.492 - Pier 3, B-003-0-23							
14-inch CIP	10.0	260	10.0	260	0.0	260	1.0
Bridge GRE-68-BK80020-00.492 - Forward Abutment, B-004-0-23							
12-inch CIP	12.7	165	13.3	165	0.6	156	1.1
Notes: 1. The length of pile from bottom of pile cap (pile cap bearing elevation) to the depth at which the required UBV is obtained. 2. Resistance factor for driven piles, dynamic analysis and static load test methods (BDM Table 305-1) for piles installed according to C&MS 507 using 3. EOID is based on driving resistance obtained at the indicated geotechnical pile length.							

It should be noted that the proposed Pier 2, Pier 3 and Forward Abutment locations are located within a floodplain of the nearby Oldtown Creek, and therefore, are susceptible to loss of foundation soil due to scour. For this purpose, Carpenter Marty performed a scour analysis at each of the referenced substructures to determine the magnitude of scour that could potentially occur and provided NEAS with these values via email on February 4, 2025. Based on the scour analysis, it was determined that the potential depth of scour at each of the referenced substructures would not extend below pile cap elevation. Therefore, no loss of skin friction due to the loss of material associated with scour was accounted for in our pile analysis.

2.3.3. Pile Drivability

NEAS's pile drivability evaluation estimated a Delmag D19-42 diesel hammer to determine if the pile type or size being considered would be either overstressed (i.e., compressive stresses experienced by pile during driving are greater than 90% of the yield strength of the steel) or encounter driving refusal (i.e., hammer blow counts higher than 100 blows per foot) at any time during pile installation. The results of the evaluation

Structure Foundation Exploration Report
Bridge GRE-68-BK80020-00.492
GRE-68-12.65
Greene County, Ohio
PID: 115388

indicated that the planned CIP pile sizes would be overstressed during the pile installation process at the each substructure location based on: 1) a minimum wall thickness of 0.25-inches; 2) the use of ASTM A 252 Grade 2 steel piles; 3) a pile hammer with a minimum rated energy of 42,000 ft-lbs; and, 4) our developed model used in the computer program *GRLWEAP* by GRL Engineers, Inc. Based on the results of our drivability analysis, to prevent potential overstressing of proposed pile foundations during pile installation we recommend that ASTM A 252 Grade 3 steel piles be utilized for the pile foundations at each substructure. Furthermore, our drivability analysis determined that additional measures are necessary to ensure piles do not overstress during pile installation including: 1) pre-boring to a specified elevation prior to driving; and/or, 2) increasing the minimum pile wall thickness greater than 0.25-inches. Specific recommendations regarding minimum required pile wall thickness and recommended pre-bore elevation, per substructure location, are provided in Table 7 of this report. *GRLWEAP* results for each substructure location are included within Appendix 2A.

It should be noted that the driving resistance of CIP piles through soils encountered at the bridge site is expected to be high. Drivability is difficult to assess quantitatively as the field test results (i.e., SPT N_{60} values, pocket penetrometer values, etc.) tend to be very high. Therefore, it is recommended that drivability be closely monitored during pile installation to prevent overstressing of the piles.

2.3.4. Pile Foundation Recommendations

Based on our evaluation of the subsurface conditions and our geotechnical engineering analysis for the proposed GRE-68-BK80020-00.492 bridge, it is our opinion that the bridge foundations can be supported on driven friction CIP piles seated within the stiff to hard/ dense to very dense natural subsurface material encountered at the site.

We recommend that a driven pile foundation be used for support for the proposed bridge foundations. New 12-inch diameter (Pier 1 and Forward Abutment) and 14-inch diameter (Rear Abutment, Pier 2 and Pier 3) CIP piles consisting of ASTM A 252, Grade 3 steel are recommended to be installed in accordance with Sections 507 and 523 of ODOT's CMS. During driving conditions and if driven to the UBV's indicated in Table 6 of this report, it is anticipated that the newly driven CIP piles would not "run" for extended depths any of the proposed substructures (i.e., run lengths greater than 10 ft). Therefore, pile/soil setup will not be utilized during the installation process at this structure, and it is recommended that the proposed piles be driven to the required UBV. It is recommended that all applicable plan notes provided in Section 606.2 be included in the plans.

When new piles are installed in accordance with referenced construction specifications utilizing the referenced method as specified in the ODOT BDM at the proposed substructure locations, the proposed CIP pile sizes (indicated in Table 7 below) driven to the required UBV's (indicated in Table 6) may be used to support a total factored load (single pile) of: 1) 205.0 kips at the rear abutment; 2) 158.6 kips at Pier 1; 3) 212.1 kips at Pier 2; 4) 181.8 kips at the Pier 3; and, 5) 115.4 kips at the Forward Abutment. For piles driven to the indicated UBV's, pile tip elevations are estimated to range from about 800 to 820 ft amsl across the bridge site.

Prior to pile driving at the proposed Rear Abutment and Pier 1 location, to minimize potential impact of pile driving operations on the nearby residential homes, pile locations are planned to be pre-bored to an elevation extending below the basements of the nearby homes. At other substructures, pre-boring prior to pile driving is planned to either avoid over-stressing of the piles by bypassing a shallow dense layer (Pier 2) or to achieve the minimum pile penetration requirements per the ODOT BDM Section 305.3.5.7 (Pier 3).

Structure Foundation Exploration Report
Bridge GRE-68-BK80020-00.492
GRE-68-12.65
Greene County, Ohio
PID: 115388

Pile lengths based on: 1) our Deep Foundation Analysis (presented in Section 2.3.2); and, 2) the "Estimated Length" and "Order Length" definitions and formulas presented in Section 305.3.5.2 of the ODOT BDM, are presented in Tables 7 below.

Table 7: Estimated Pile Lengths

Pile Type (ASTM A252)	Bottom of Pile Cap Elevation (ft amsl)	Geotechnical Pile Length (ft)	Geotechnical Pile Tip Elevation (ft amsl)	Estimated Pile Length ⁽¹⁾ (ft)	Order Length ⁽¹⁾ (ft)	Prebore Elevation (ft amsl)	Minimum Pile Wall Thickness (inches)
Bridge GRE-68-BK80020-00.492 - Rear Abutment, B-001-0-23							
14-inch CIP (Grade 3)	832.7	12.5	820.2	20	25	825.00 ⁽²⁾	0.438
Bridge GRE-68-BK80020-00.492 - Pier 1, B-002-0-23							
12-inch CIP (Grade 3)	831.0	13.0	818.0	20	25	825.00 ⁽²⁾	0.250
Bridge GRE-68-BK80020-00.492 - Pier 2, B-002-1-24							
14-inch CIP (Grade 3)	824.0	23.8 ⁽²⁾	800.2	30	35	810.00 ⁽³⁾	0.312
Bridge GRE-68-BK80020-00.492 - Pier 3, B-003-0-23							
14-inch CIP (Grade 3)	822.8	10.0 ⁽²⁾	812.8	15	20	812.75 ⁽³⁾	0.312
Bridge GRE-68-BK80020-00.492 - Forward Abutment, B-004-0-23							
12-inch CIP (Grade 3)	823.3	13.3	810.0	20	25	N/A	0.250
Notes: 1. Based on definitions and formulas presented in Section 303.3.5.2 of the 2020 BDM. 2. Prebore planned to minimize impact of pile driving on nearby basement structures. 3. Prebore required to either avoid overstressing of piles during driving or to achieve minimum pile soil embedment requirements per BDM Section 305.3.5.7.							

2.3.5. Settlement and Downdrag

At the rear abutment location, long-term settlement resulting from the retaining wall and embankment induced loading was reviewed at the referenced pile foundation location to evaluate whether the long-term settlement may have an impact (i.e., downdrag) on the planned pile foundations. Based on our settlement analysis, the maximum long-term settlement at the proposed rear abutment pile locations was estimated to be about 0.1 inches. This estimated magnitude is not anticipated to be an issue as it is less than 0.4 inches of long-term (consolidation) settlement (i.e., the threshold at which downdrag loading should be considered per ODOT BDM Sections 305.3.2.2 and 305.4.1.2 "Downdrag and Drag Load"). Additional information regarding the settlement analysis performed (including settlement program outputs) can be found within Section 3: Retaining Walls of this report.

APPENDIX 2A
GRLWEAP ANALYSIS

REAR ABUTMENT

Driveability Analysis Summary
 Gain/Loss Factor at Shaft/Toe = 0.571/1.000

Depth ft	Rut kips	Rshaft kips	Rtoe kips	Blow Ct bl/ft	Mx C-Str ksi	Mx T-Str. ksi	Stroke ft	ENTHRU kip-ft	Hammer -
5.0	1.2	0.0	1.2	0.3	0.000	0.000	10.81	0.0	D 19-42
10.0	2.5	0.0	2.5	0.3	0.000	0.000	10.81	0.0	D 19-42
15.0	257.0	19.6	237.4	32.0	34.399	1.634	7.94	19.7	D 19-42
16.8	292.9	33.0	259.9	37.4	36.292	2.324	8.29	20.3	D 19-42
20.0	359.2	59.6	299.6	51.0	38.577	4.409	8.91	21.2	D 19-42
25.0	470.7	108.9	361.8	88.5	41.619	7.907	9.98	23.6	D 19-42
30.0	501.6	166.3	335.3	109.4	37.350	8.390	10.11	24.0	D 19-42
35.0	561.5	226.2	335.3	159.2	34.553	8.634	10.28	24.4	D 19-42
40.0	627.3	292.0	335.3	279.3	34.331	7.969	10.37	24.6	D 19-42
45.0	699.0	363.6	335.3	696.6	34.490	7.559	10.33	24.1	D 19-42
50.0	530.7	446.5	84.2	104.7	32.199	4.097	9.35	21.1	D 19-42
51.0	552.1	467.9	84.2	133.3	32.536	4.073	9.49	20.9	D 19-42

Total driving time: 199 minutes; Total Number of Blows: 7459 (starting at penetration 5.0 ft)

0 ft @ Ele. 837.0 ft amsl (832.7 ft amsl pile cap + 4.3 ft of overburden)
 Analysis Assuming 7.7 ft of Pre-bore to ele. 825.0 ft amsl
 Zero-friction length = 837.0-825.0 ft amsl = 12.0 ft

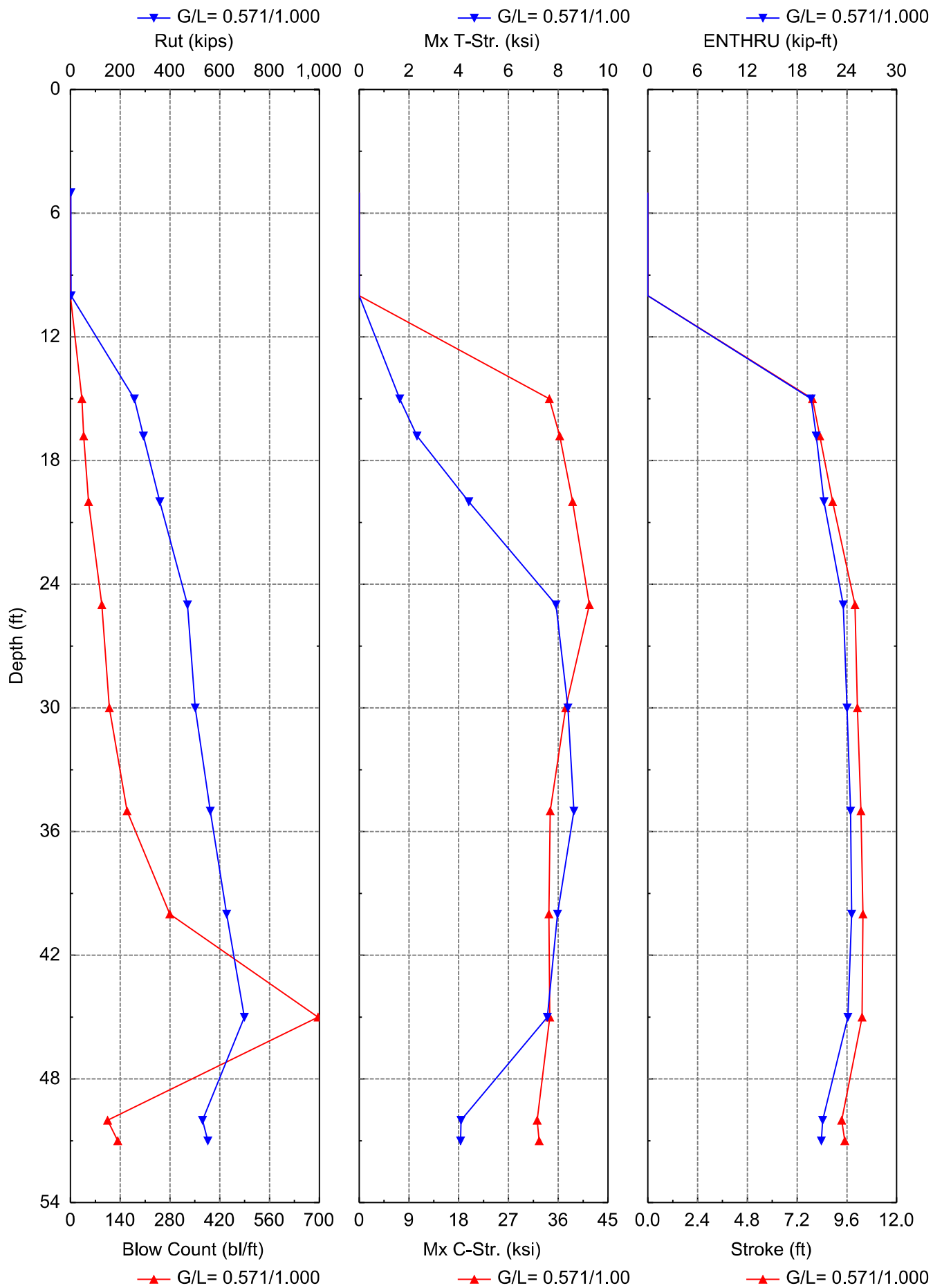

Driveability Analysis Summary
 Gain/Loss Factor at Shaft/Toe = 1.000/1.000

Depth ft	Rut kips	Rshaft kips	Rtoe kips	Blow Ct bl/ft	Mx C-Str ksi	Mx T-Str. ksi	Stroke ft	ENTHRU kip-ft	Hammer -
5.0	1.2	0.0	1.2	0.3	0.000	0.000	10.81	0.0	D 19-42
10.0	2.5	0.0	2.5	0.3	0.000	0.000	10.81	0.0	D 19-42
15.0	257.0	19.6	237.4	32.0	34.399	1.634	7.94	19.7	D 19-42
16.8	292.9	33.0	259.9	37.4	36.292	2.324	8.29	20.3	D 19-42
20.0	359.2	59.6	299.6	51.0	38.577	4.409	8.91	21.2	D 19-42
25.0	470.7	108.9	361.8	88.5	41.619	7.907	9.98	23.6	D 19-42
30.0	501.6	166.3	335.3	109.4	37.350	8.390	10.11	24.0	D 19-42
35.0	561.5	226.2	335.3	159.2	34.553	8.634	10.28	24.4	D 19-42
40.0	627.3	292.0	335.3	279.3	34.331	7.969	10.37	24.6	D 19-42
45.0	699.0	363.6	335.3	696.6	34.490	7.559	10.33	24.1	D 19-42
50.0	541.4	457.2	84.2	115.4	32.376	4.129	9.44	21.2	D 19-42
51.0	573.5	489.3	84.2	155.8	32.987	4.218	9.63	21.5	D 19-42

Total driving time: 200 minutes; Total Number of Blows: 7502 (starting at penetration 5.0 ft)

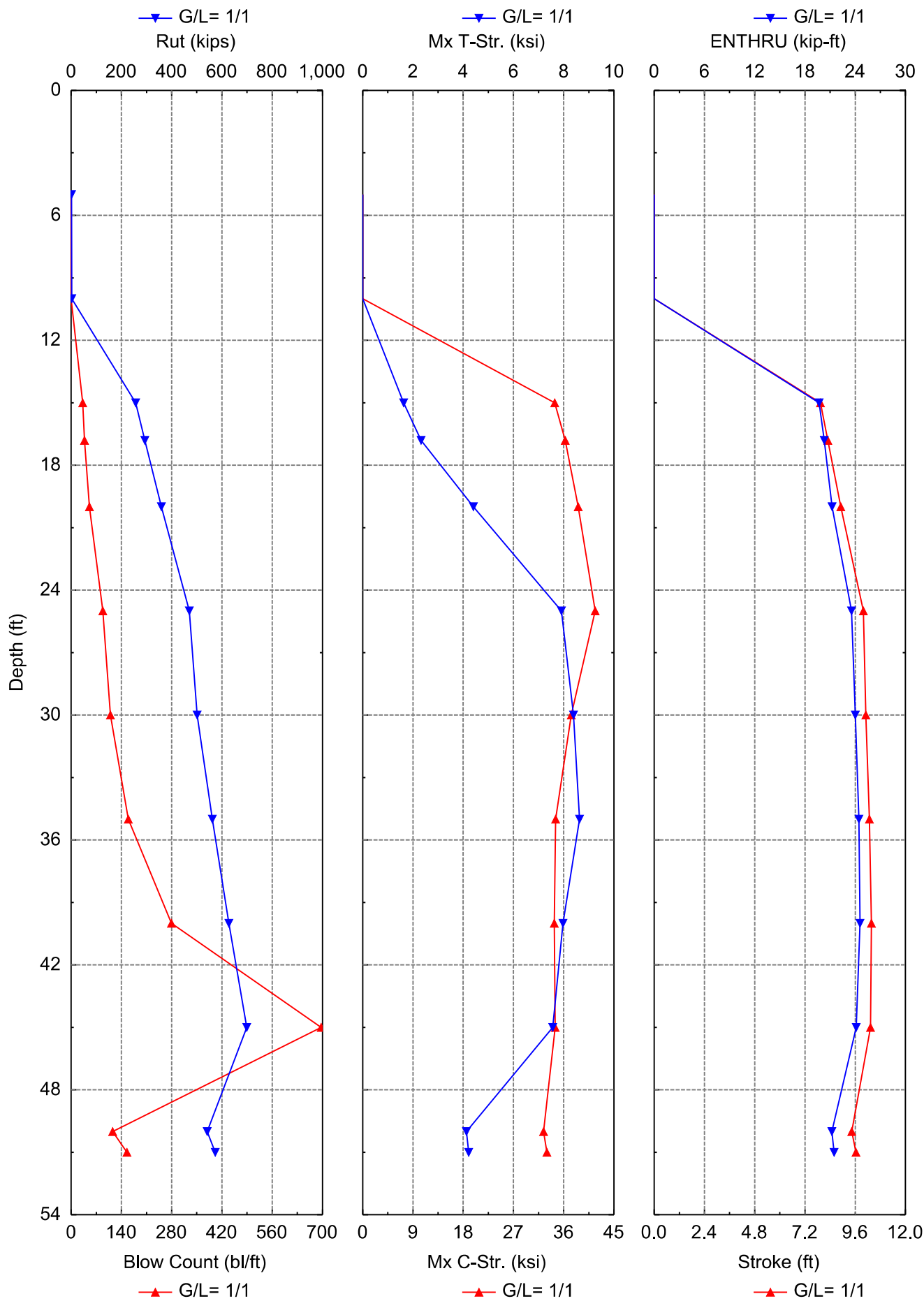

SOIL PROFILE

Depth ft	Soil Type -	Spec. Wt lb/ft ³	Su ksf	Phi °	Unit Rs ksf	Unit Rt ksf
0.0	Sand	130.0	0.0	0.0	0.00	0.00
12.0	Sand	130.0	0.0	0.0	0.00	2.77
12.0	Sand	130.0	0.0	40.0	1.23	187.20
29.0	Sand	130.0	0.0	40.0	2.52	375.94
29.0	Sand	130.0	0.0	39.0	2.31	313.69
49.0	Sand	130.0	0.0	39.0	3.28	313.69
49.0	Clay	140.0	8.7	0.0	8.75	78.75
50.5	Clay	140.0	8.7	0.0	8.75	78.75

0 ft @ Ele. 837.0 ft amsl (832.7 ft amsl pile cap + 4.3 ft of overburden)

Analysis Assuming 7.7 ft of Pre-bore to ele. 825.0 ft amsl

Zero-friction length = 837.0-825.0 ft amsl = 12.0 ft

GRLWEAP: Wave Equation Analysis of Pile Foundations

Proposed Pedestrian Bridge + Rear Abutment
NATIONAL ENGINEERING AND ARCHITECTURAL

2/11/2025
GRLWEAP 14.1.20.1

ABOUT THE WAVE EQUATION ANALYSIS RESULTS

The GRLWEAP program simulates the behavior of a preformed pile driven by either an impact hammer or a vibratory hammer. The program is based on mathematical models, which describe motion and forces of hammer, driving system, pile and soil under the hammer action. Under certain conditions, the models only crudely approximate, often complex, dynamic situations.

A wave equation analysis generally relies on input data, which represents normal situations. In particular, the hammer data file supplied with the program assumes that the hammer is in good working order. All of the input data selected by the user may be the best available information at the time when the analysis is performed. However, input data and therefore results may significantly differ from actual field conditions.

Therefore, the program authors recommend prudent use of the GRLWEAP results. Soil response and hammer performance should be verified by static and/or dynamic testing and measurements. Estimates of bending or other local stresses (e.g., helmet or clamp contact, uneven rock surfaces etc.), prestress effects and others must also be accounted for by the user.

The calculated capacity-blow count relationship, i.e. the bearing graph, should be used in conjunction with observed blow counts for the capacity assessment of a driven pile. Soil setup occurring after pile installation may produce bearing capacity values that differ substantially from those expected from a wave equation analysis due to soil setup or relaxation. This is particularly true for pile driven with vibratory hammers. The GRLWEAP user must estimate such effects and should also use proper care when applying blow counts from restrrike because of the variability of hammer energy, soil resistance and blow count during early restriking.

Finally, the GRLWEAP capacities are ultimate values. They MUST be reduced by means of an appropriate factor of safety to yield a design or working load. The selection of a factor of safety should consider the quality of the construction control, the variability of the site conditions, uncertainties in the loads, the importance of structure and other factors.

HAMMER DATA

Hammer Model:	D 19-42	Made By:	DELMAG
Hammer ID:	41	Hammer Type:	OED
Hammer Database Type:	PDI		
Hammer Database Name:			PDIHammer.gwh

Hammer and Drive System Segment Data

Segment	Weight kips	Stiffness kips/in	COR	C-Slack in	Damping kips/ft/s
-			-		
1	0.800	140,084.4	1.000	0.000	
2	0.800	140,084.4	1.000	0.000	
3	0.800	140,084.4	1.000	0.000	
4	0.800	140,084.4	1.000	0.000	
5	0.800	70,754.7	0.900	0.120	
Imp Block	0.753	109,976.0	0.800	0.120	
Helmet	2.500				5.3

Ram Weight: (kips)	4.00	Ram Length: (ft)	10.76
Ram Area: (in ²)	124.69		
Maximum (Eq) Stroke: (ft)	10.81	Actual (Eq) Stroke: (ft)	10.81
Efficiency:	0.800	Rated Energy: (kip-ft)	43.24
Maximum Pressure: (psi)	1,600.00	Actual Pressure: (psi)	1,600.00
Combustion Delay: (ms)	2.00	Ignition Duration: (ms)	2.00
Expansion Exponent:	1.25		

Hammer Cushion		Pile Cushion	
Cross Sect. Area: (in ²)	415.00	Cross Sect. Area: (in ²)	0.00
Elastic Modulus: (ksi)	530.0	Elastic Modulus: (ksi)	0.0
Thickness: (in)	2.00	Thickness: (in)	0.00
Coeff. of Restitution:	0.800	Coeff. of Restitution:	0.500
RoundOut: (in)	0.120	RoundOut: (in)	0.120
Stiffness: (kips/in)	109,976.0	Stiffness: (kips/in)	0.0
Helmet Weight: (kips)	2.500		

PILE INPUT

Uniform Pile		Pile Type:	Closed-End Pipe
Pile Length: (ft)	55.000	Pile Penetration: (ft)	51.000
Pile Size: (ft)	1.17	Toe Area: (in ²)	153.94

Table of Depths Analyzed with Driving System Modifiers

Depth ft	Temp Length ft	Wait Time Hr	Hammer -
5.00	55.0	0.0	DELMAG D 19-42
10.00	55.0	0.0	DELMAG D 19-42
15.00	55.0	0.0	DELMAG D 19-42
16.81	55.0	0.0	DELMAG D 19-42
20.00	55.0	0.0	DELMAG D 19-42
25.00	55.0	0.0	DELMAG D 19-42
30.00	55.0	0.0	DELMAG D 19-42
35.00	55.0	0.0	DELMAG D 19-42
40.00	55.0	0.0	DELMAG D 19-42
45.00	55.0	0.0	DELMAG D 19-42
50.00	55.0	0.0	DELMAG D 19-42
51.00	55.0	0.0	DELMAG D 19-42

Other Information for DELMAG D 19-42

Depth ft	Stroke ft	Diesel Pressure %	Efficiency -	P.C. Stiff. Fact. -	P.C. COR -
5.00	10.8	100.0	0.80	1.0	0.50
10.00	10.8	100.0	0.80	1.0	0.50
15.00	10.8	100.0	0.80	1.0	0.50
16.81	10.8	100.0	0.80	1.0	0.50
20.00	10.8	100.0	0.80	1.0	0.50
25.00	10.8	100.0	0.80	1.0	0.50
30.00	10.8	100.0	0.80	1.0	0.50
35.00	10.8	100.0	0.80	1.0	0.50
40.00	10.8	100.0	0.80	1.0	0.50
45.00	10.8	100.0	0.80	1.0	0.50
50.00	10.8	100.0	0.80	1.0	0.50
51.00	10.8	100.0	0.80	1.0	0.50

PILE, SOIL, ANALYSIS OPTIONS

Analysis type:	Driveability Analysis	Soil Damping Option:	Smith
Max No Analysis Iterations:	0	Time Increment/Critical:	160
Residual Stress Analysis:	0	Analysis Time-Input(ms):	0
Output Level:	Normal	Gravitational Acceleration (ft/s ²):	32.169
Hammer Gravity (ft/s ²):	32.169	Pile Gravity (ft/s ²):	32.169

DRIVEABILITY ANALYSIS

Analysis Depth (ft)	51.00	Standard Soil Setup	
Hammer Name	DELMAG D 19-42	Hammer ID	41
Diesel Pressure: (psi)	230.40	Stroke (ft)	10.81
Efficiency	0.80		
Shaft Gain/Loss Factor	0.571	Toe Gain/Loss Factor	1.000
Shaft Gain/Loss Factor	1.000	Toe Gain/Loss Factor	1.000

SOIL RESISTANCE PARAMETERS

Depth ft	Unit Rs ksf	Unit Rt ksf	Qs in	Qt in	Js s/ft	Jt s/ft	Setup F. -	Limit D. ft	Setup TEB Hours	Area in ²
0.00	0.0	0.0	0.10	0.140	0.200	0.1	1.8	6.00	168.0	153.94
1.71	0.0	0.4	0.10	0.140	0.200	0.1	1.8	6.00	168.0	153.94
3.43	0.0	0.8	0.10	0.140	0.200	0.1	1.8	6.00	168.0	153.94
5.14	0.0	1.2	0.10	0.140	0.200	0.1	1.8	6.00	168.0	153.94
6.86	0.0	1.6	0.10	0.140	0.200	0.1	1.8	6.00	168.0	153.94
8.57	0.0	2.0	0.10	0.140	0.200	0.1	1.8	6.00	168.0	153.94
10.29	0.0	2.4	0.10	0.140	0.200	0.1	1.8	6.00	168.0	153.94
12.00	0.0	2.8	0.10	0.140	0.200	0.1	1.8	6.00	168.0	153.94
12.00	1.6	187.2	0.10	0.116	0.050	0.1	1.0	6.00	1.0	153.94
13.70	1.8	207.0	0.10	0.116	0.050	0.1	1.0	6.00	1.0	153.94
15.40	2.0	226.8	0.10	0.116	0.050	0.1	1.0	6.00	1.0	153.94
17.10	2.1	246.5	0.10	0.116	0.050	0.1	1.0	6.00	1.0	153.94
18.80	2.3	266.3	0.10	0.116	0.050	0.1	1.0	6.00	1.0	153.94
20.50	2.5	286.1	0.10	0.116	0.050	0.1	1.0	6.00	1.0	153.94
22.20	2.7	305.9	0.10	0.116	0.050	0.1	1.0	6.00	1.0	153.94
23.90	2.8	325.6	0.10	0.116	0.050	0.1	1.0	6.00	1.0	153.94
25.60	3.0	345.4	0.10	0.116	0.050	0.1	1.0	6.00	1.0	153.94
27.30	3.2	365.2	0.10	0.116	0.050	0.1	1.0	6.00	1.0	153.94
29.00	3.3	375.9	0.10	0.116	0.050	0.1	1.0	6.00	1.0	153.94
29.00	3.0	313.7	0.10	0.124	0.050	0.1	1.0	6.00	1.0	153.94
30.67	3.2	313.7	0.10	0.124	0.050	0.1	1.0	6.00	1.0	153.94
32.33	3.3	313.7	0.10	0.124	0.050	0.1	1.0	6.00	1.0	153.94
34.00	3.4	313.7	0.10	0.124	0.050	0.1	1.0	6.00	1.0	153.94
35.67	3.5	313.7	0.10	0.124	0.050	0.1	1.0	6.00	1.0	153.94
37.33	3.6	313.7	0.10	0.124	0.050	0.1	1.0	6.00	1.0	153.94
39.00	3.7	313.7	0.10	0.124	0.050	0.1	1.0	6.00	1.0	153.94
40.67	3.8	313.7	0.10	0.124	0.050	0.1	1.0	6.00	1.0	153.94
42.33	3.9	313.7	0.10	0.124	0.050	0.1	1.0	6.00	1.0	153.94
44.00	4.0	313.7	0.10	0.124	0.050	0.1	1.0	6.00	1.0	153.94
45.67	4.1	313.7	0.10	0.124	0.050	0.1	1.0	6.00	1.0	153.94
47.33	4.2	313.7	0.10	0.124	0.050	0.1	1.0	6.00	1.0	153.94

Proposed Pedestrian Bridge + Retention Wall NATIONAL ENGINEERING AND ARCHITECTURAL

49.00	4.3	313.7	0.10	0.124	0.050	0.1	1.0	6.00	1.0	153.94
49.00	8.7	78.7	0.10	0.100	0.150	0.1	1.5	6.00	168.0	153.94
51.00	8.7	78.7	0.10	0.100	0.150	0.1	1.5	6.00	168.0	153.94

PILE PROFILE

Lb Top ft	X-Area in ²	E-Mod ksi	Spec. Wt lb/ft ³	Perim. ft	C-Index -	Wave Sp ft/s	Impedance kips/ft/s
0.00	18.7	30,000	492.00	3.665	0	16,806.4	33.3
55.00	18.7	30,000	492.00	3.665	0	16,806.4	33.3

PILE AND SOIL MODEL Total Capacity Rut (kips): 552.115

Seg.	Weight kips	Stiffn. kips/in	C-Slk in	T-Slk in	COR -	Ru kips	Js/Jt s/ft	Qs/Qt in	LbTop ft	Perim. ft	X-Area in ²
1	0.21	14,420	0.12	0.00	0.85	0.0	0.000	0.10	3.24	3.67	18.7
2	0.21	14,420	0.00	0.00	1.00	0.0	0.000	0.10	6.47	3.67	18.7
4	0.21	14,420	0.00	0.00	1.00	0.0	0.000	0.10	12.94	3.67	18.7
5	0.21	14,420	0.00	0.00	1.00	1.1	0.050	0.10	16.18	3.67	18.7
6	0.21	14,420	0.00	0.00	1.00	21.5	0.050	0.10	19.41	3.67	18.7
7	0.21	14,420	0.00	0.00	1.00	25.3	0.050	0.10	22.65	3.67	18.7
8	0.21	14,420	0.00	0.00	1.00	29.2	0.050	0.10	25.88	3.67	18.7
9	0.21	14,420	0.00	0.00	1.00	33.1	0.050	0.10	29.12	3.67	18.7
10	0.21	14,420	0.00	0.00	1.00	37.0	0.050	0.10	32.35	3.67	18.7
11	0.21	14,420	0.00	0.00	1.00	37.5	0.050	0.10	35.59	3.67	18.7
12	0.21	14,420	0.00	0.00	1.00	39.3	0.050	0.10	38.82	3.67	18.7
13	0.21	14,420	0.00	0.00	1.00	41.8	0.050	0.10	42.06	3.67	18.7
14	0.21	14,420	0.00	0.00	1.00	44.2	0.050	0.10	45.29	3.67	18.7
15	0.21	14,420	0.00	0.00	1.00	46.7	0.050	0.10	48.53	3.67	18.7
16	0.21	14,420	0.00	0.00	1.00	49.1	0.050	0.10	51.76	3.67	18.7
17	0.21	14,420	0.00	0.00	1.00	62.2	0.127	0.10	55.00	3.67	18.7
Toe						84.2	0.149	0.10	55.00		

3.507 kips total unreduced pile weight (g = 32.169 ft/s²)

3.507 kips total reduced pile weight (g = 32.169 ft/s²)

OTHER OPTIONS

Pile Damping (%):	1	Pile Damping Fact. (kips/ft/s):	0.666
-------------------	---	---------------------------------	-------

EXTREMA TABLE at 51.0 FT; HAMMER: D 19-42

Shaft/Toe Gain/Loss Factor = 0.571/1.000

Rut = 552.1 kips Rtoe = 84.2 kips Time Inc. = 0.076 ms

Hammer DELMAG D 19-42 Efficiency 0.800

Lb Top ft	Mx.T-For. kips	Mx.C-For kips	Mx.T-Str. ksi	Mx.C-Str. ksi	Mx Vel. ft/s	Mx Dis. in	ENTHRU kip-ft
3.2	0.0	579.9	0.00	31.07	16.17	0.606	20.91
6.5	24.2	580.0	1.29	31.08	16.06	0.578	20.46
9.7	45.2	579.8	2.42	31.07	15.93	0.549	19.96
12.9	61.6	581.2	3.30	31.14	15.74	0.519	19.44
16.2	71.1	590.1	3.81	31.62	15.35	0.487	18.81
19.4	76.0	607.2	4.07	32.54	14.80	0.453	17.55
22.6	65.1	590.6	3.49	31.65	14.15	0.418	15.76
25.9	49.7	570.8	2.67	30.59	13.43	0.386	14.00
29.1	32.7	547.2	1.75	29.32	12.67	0.354	12.25
32.4	8.4	519.2	0.45	27.82	11.94	0.324	10.55
35.6	0.0	486.1	0.00	26.05	11.27	0.297	9.00
38.8	0.0	454.2	0.00	24.34	10.63	0.271	7.63
42.1	0.0	419.0	0.00	22.45	10.00	0.250	6.42
45.3	0.0	380.6	0.00	20.40	9.52	0.230	5.31
48.5	0.0	341.6	0.00	18.30	9.61	0.214	4.31
51.8	0.0	281.6	0.00	15.09	10.35	0.200	3.40
55.0	0.0	252.3	0.00	13.52	9.97	0.190	2.95

Converged Stroke (ft) 9.49 Fixed Combustion Pressure (psi) 1,600.0

(Eq) Strokes Analyzed and Last Return (ft)

10.81 9.41 9.49

Shaft/Toe Gain/Loss Factor = 1.000/1.000

Rut = 573.5 kips Rtoe = 84.2 kips Time Inc. = 0.076 ms

Hammer DELMAG D 19-42 Efficiency 0.800

Lb Top ft	Mx.T-For. kips	Mx.C-For kips	Mx.T-Str. ksi	Mx.C-Str. ksi	Mx Vel. ft/s	Mx Dis. in	ENTHRU kip-ft
3.2	0.0	588.1	0.00	31.51	16.44	0.613	21.47
6.5	23.2	588.2	1.24	31.52	16.32	0.584	20.99
9.7	43.3	588.1	2.32	31.51	16.20	0.555	20.48
12.9	60.4	589.3	3.23	31.58	16.00	0.525	19.93
16.2	72.1	598.3	3.86	32.06	15.61	0.492	19.26
19.4	78.7	615.6	4.22	32.99	15.05	0.456	17.94
22.6	67.5	599.1	3.62	32.10	14.40	0.419	16.04
25.9	54.2	579.1	2.90	31.03	13.67	0.385	14.18
29.1	38.5	555.5	2.06	29.77	12.90	0.352	12.37

Proposed Pedestrian Bridge + Reservoir NATIONAL ENGINEERING AND ARCHITECTURAL

32.4	16.0	527.4	0.86	28.26	12.15	0.320	10.62
35.6	0.0	494.2	0.00	26.48	11.48	0.291	9.04
38.8	0.0	462.2	0.00	24.77	10.81	0.266	7.66
42.1	0.0	427.0	0.00	22.88	10.16	0.242	6.41
45.3	0.0	387.7	0.00	20.77	9.68	0.221	5.30
48.5	0.0	348.2	0.00	18.66	9.73	0.202	4.30
51.8	0.0	305.0	0.00	16.35	10.31	0.188	3.44
55.0	0.0	281.1	0.00	15.06	9.70	0.177	3.01

Converged Stroke (ft) 9.63 Fixed Combustion Pressure (psi) 1,600.0
 (Eq) Strokes Analyzed and Last Return (ft)
 10.81 9.61 9.63

SUMMARY TABLE at 51.0 FT; HAMMER: D 19-42

Rut	BI Ct	Stk Dn	Stk Up	Mx T-Str	LTop	Mx C-Str	LTop	ENTHRU	BI Rt	ActRes
kips	b/ft	ft	ft	ksi	ft	ksi	ft	kip-ft	b/min	kips
552.1	133.3	9.49	0.00	4.07	19.4	32.54	19.4	20.9	38.5	552.1
573.5	155.8	9.63	0.00	4.22	19.4	32.99	19.4	21.5	38.2	573.5

SUMMARY OVER DEPTHS

G/L at Shaft and Toe: 0.571/1.000

Depth ft	Rut kips	Rshaft kips	Rtoe kips	BI Ct b/ft	Mx C-Str ksi	Mx T-Str ksi	Stroke ft	ENTHRU kip-ft	Hammer -
5.0	1.2	0.0	1.2	0.0	0.00	0.00	10.81	0.0	D 19-42
10.0	2.5	0.0	2.5	0.0	0.00	0.00	10.81	0.0	D 19-42
15.0	257.0	19.6	237.4	32.0	34.40	1.63	7.94	19.7	D 19-42
16.8	292.9	33.0	259.9	37.4	36.29	2.32	8.29	20.3	D 19-42
20.0	359.2	59.6	299.6	51.0	38.58	4.41	8.91	21.2	D 19-42
25.0	470.7	108.9	361.8	88.5	41.62	7.91	9.98	23.6	D 19-42
30.0	501.6	166.3	335.3	109.4	37.35	8.39	10.11	24.0	D 19-42
35.0	561.5	226.2	335.3	159.2	34.55	8.63	10.28	24.4	D 19-42
40.0	627.3	292.0	335.3	279.3	34.33	7.97	10.37	24.6	D 19-42
45.0	699.0	363.6	335.3	696.6	34.49	7.56	10.33	24.1	D 19-42
50.0	530.7	446.5	84.2	104.7	32.20	4.10	9.35	21.1	D 19-42
51.0	552.1	467.9	84.2	133.3	32.54	4.07	9.49	20.9	D 19-42

G/L at Shaft and Toe: 1.000/1.000

Depth ft	Rut kips	Rshaft kips	Rtoe kips	BI Ct b/ft	Mx C-Str ksi	Mx T-Str ksi	Stroke ft	ENTHRU kip-ft	Hammer -
5.0	1.2	0.0	1.2	0.0	0.00	0.00	10.81	0.0	D 19-42
10.0	2.5	0.0	2.5	0.0	0.00	0.00	10.81	0.0	D 19-42
15.0	257.0	19.6	237.4	32.0	34.40	1.63	7.94	19.7	D 19-42
16.8	292.9	33.0	259.9	37.4	36.29	2.32	8.29	20.3	D 19-42
20.0	359.2	59.6	299.6	51.0	38.58	4.41	8.91	21.2	D 19-42
25.0	470.7	108.9	361.8	88.5	41.62	7.91	9.98	23.6	D 19-42
30.0	501.6	166.3	335.3	109.4	37.35	8.39	10.11	24.0	D 19-42
35.0	561.5	226.2	335.3	159.2	34.55	8.63	10.28	24.4	D 19-42
40.0	627.3	292.0	335.3	279.3	34.33	7.97	10.37	24.6	D 19-42
45.0	699.0	363.6	335.3	696.6	34.49	7.56	10.33	24.1	D 19-42
50.0	541.4	457.2	84.2	115.4	32.38	4.13	9.44	21.2	D 19-42
51.0	573.5	489.3	84.2	155.8	32.99	4.22	9.63	21.5	D 19-42

PIER 1

Driveability Analysis Summary
Gain/Loss Factor at Shaft/Toe = 0.571/1.000

Depth ft	Rut kips	Rshaft kips	Rtoe kips	Blow bl/ft	CtMx ksi	C-StrMx ksi	T-Str. ksi	Stroke ft	ENTHRU kip-ft	Hammer -
5.0	0.6	0.0	0.6	0.3	0.000	0.000	0.000	10.81	0.0	D 19-42
10.0	1.2	0.0	1.2	0.3	0.000	0.000	0.000	10.81	0.0	D 19-42
12.5	98.4	4.7	93.7	8.9	24.566	0.988	5.78	20.5	20.5	D 19-42
15.0	119.8	10.2	109.6	11.2	27.669	1.411	6.08	20.2	20.2	D 19-42
17.0	137.6	15.3	122.3	13.0	29.861	1.762	6.30	20.0	20.0	D 19-42
17.0	243.5	15.3	228.2	28.5	51.369	4.116	8.31	23.9	23.9	D 19-42
20.0	290.4	25.7	264.7	37.6	55.904	6.170	9.02	25.5	25.5	D 19-42
22.5	330.8	35.5	295.3	48.4	58.664	8.249	9.62	27.0	27.0	D 19-42
25.0	372.2	46.4	325.8	65.6	60.796	10.028	10.19	28.4	28.4	D 19-42
30.0	458.3	71.4	386.9	159.0	63.918	12.735	11.25	30.7	30.7	D 19-42
35.0	675.4	96.1	579.3	9999.0	67.307	14.171	11.97	32.2	32.2	D 19-42
40.0	704.0	124.7	579.3	9999.0	63.760	12.650	11.51	30.9	30.9	D 19-42
45.0	344.2	146.4	197.8	61.7	50.687	5.378	9.10	24.5	24.5	D 19-42
46.0	348.8	151.0	197.8	65.5	50.563	5.191	9.11	24.4	24.4	D 19-42
51.6	376.9	179.1	197.8	98.6	50.212	3.671	9.20	24.2	24.2	D 19-42

Refusal occurred; no driving time output possible.

0 ft @ Ele. 835.0 ft amsl (831.0 ft amsl pile cap + 4.0 ft of overburden)
 Analysis Assuming 10 ft of Pre-bore to ele. 825.0 ft amsl
 Zero-friction length = 835.0-825.0 ft amsl = 10.0 ft

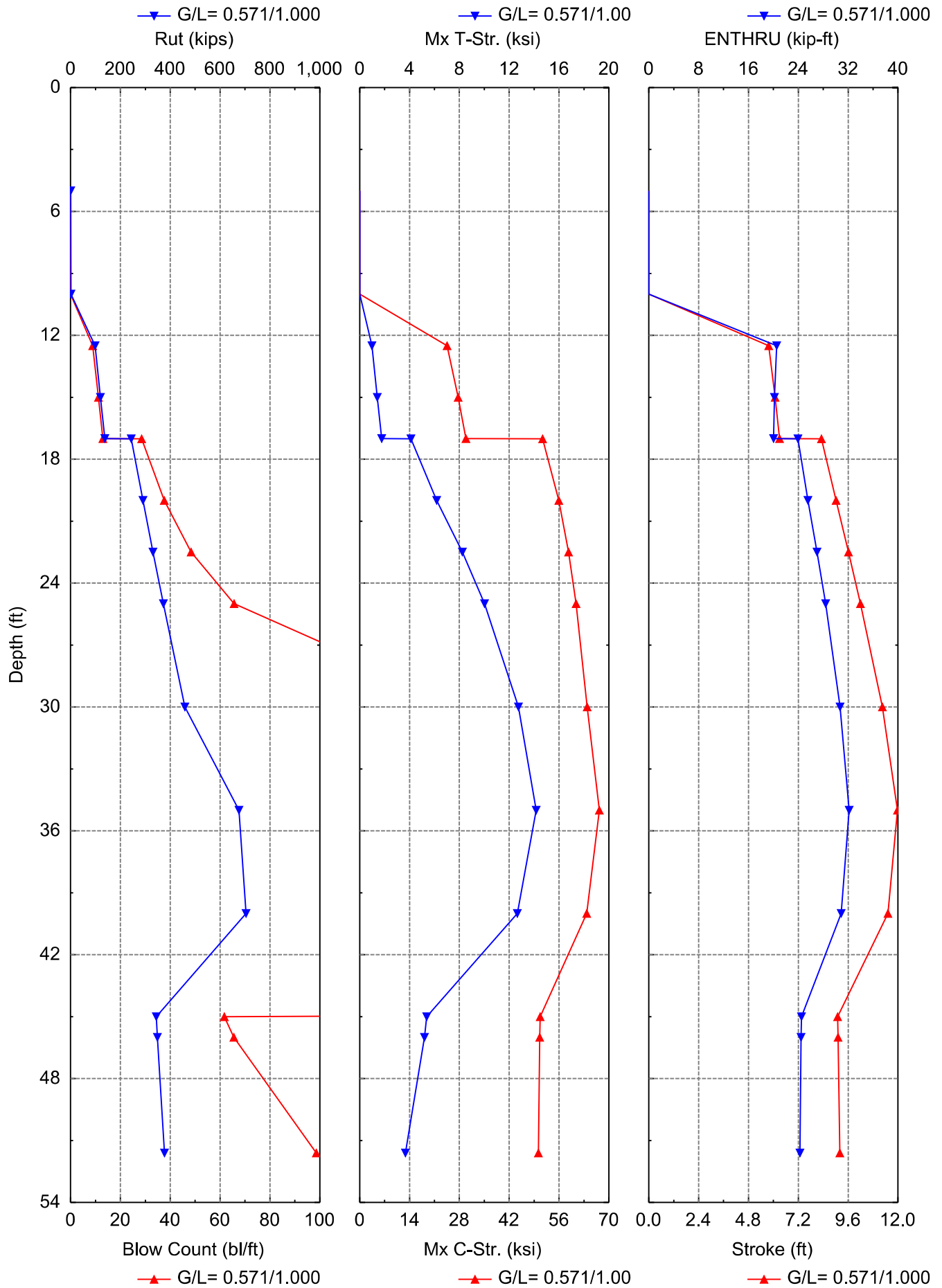

Driveability Analysis Summary
Gain/Loss Factor at Shaft/Toe = 1.000/1.000

Depth ft	Rut kips	Rshaft kips	Rtoe kips	Blow bl/ft	CtMx ksi	C-StrMx ksi	T-Str. ksi	Stroke ft	ENTHRU kip-ft	Hammer -
5.0	0.6	0.0	0.6	0.3	0.000	0.000	0.000	10.81	0.0	D 19-42
10.0	1.2	0.0	1.2	0.3	0.000	0.000	0.000	10.81	0.0	D 19-42
12.5	99.3	5.6	93.7	9.0	24.709	1.040	1.040	5.79	20.5	D 19-42
15.0	121.9	12.3	109.6	11.4	27.939	1.502	1.502	6.10	20.2	D 19-42
17.0	140.7	18.3	122.3	13.3	30.223	1.887	1.887	6.34	20.0	D 19-42
17.0	246.5	18.4	228.2	29.0	51.643	4.267	4.267	8.35	24.0	D 19-42
20.0	293.4	28.7	264.7	38.5	55.846	6.441	6.441	9.06	25.6	D 19-42
22.5	333.8	38.6	295.3	49.5	58.594	8.537	8.537	9.66	27.1	D 19-42
25.0	375.3	49.5	325.8	67.3	60.648	10.272	10.272	10.22	28.5	D 19-42
30.0	461.4	74.5	386.9	169.5	63.505	12.958	12.958	11.26	30.7	D 19-42
35.0	683.4	104.1	579.3	9999.0	66.667	14.218	14.218	11.91	32.0	D 19-42
40.0	717.7	138.4	579.3	9999.0	63.231	12.412	12.412	11.45	30.7	D 19-42
45.0	368.7	170.9	197.8	77.4	52.010	5.664	5.664	9.37	25.2	D 19-42
46.0	375.7	177.9	197.8	85.5	51.838	5.561	5.561	9.41	25.2	D 19-42
51.6	417.7	219.9	197.8	174.2	51.544	4.121	4.121	9.56	25.2	D 19-42

Refusal occurred; no driving time output possible.

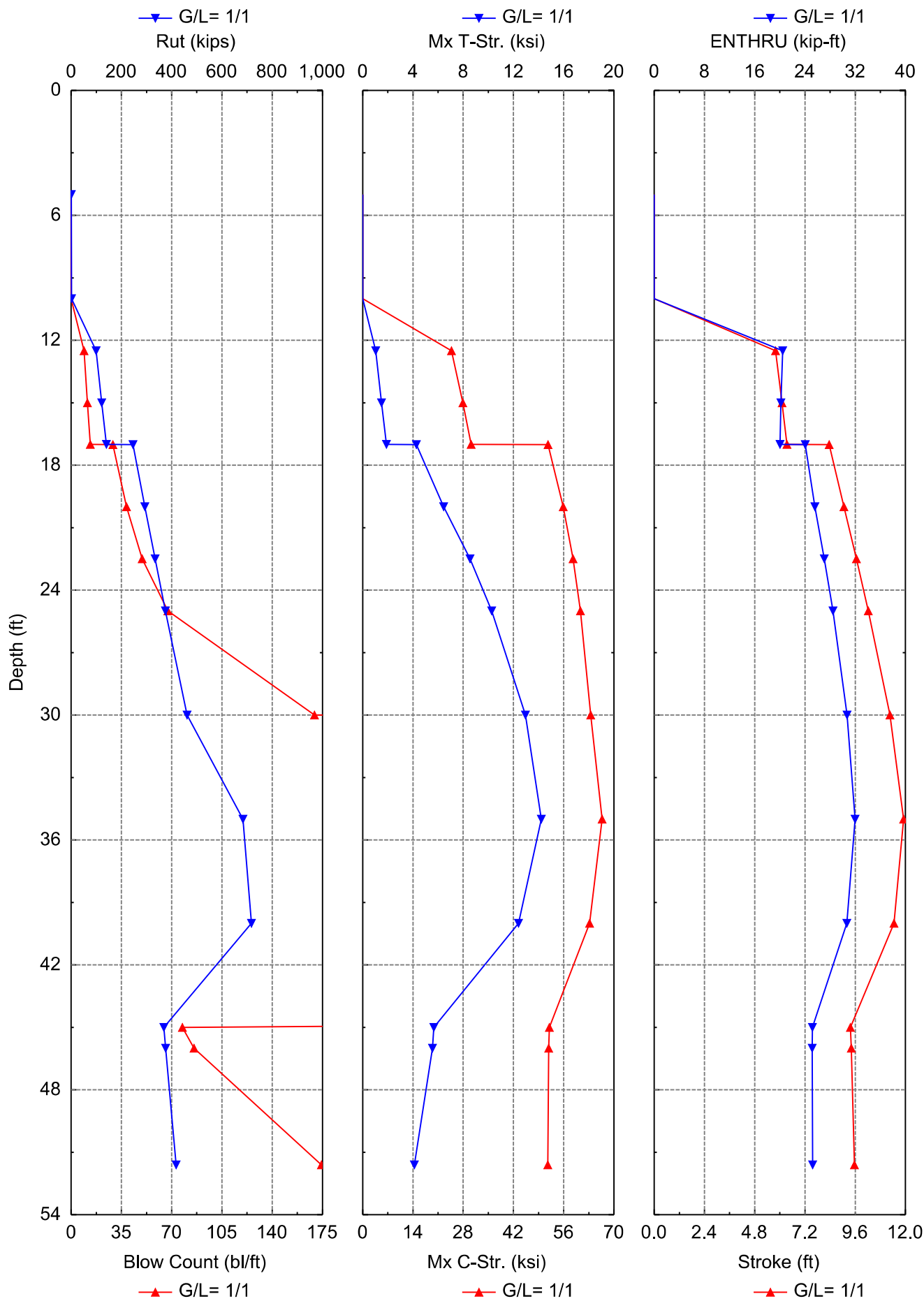

SOIL PROFILE

Depth ft	Soil Type -	Spec. Wt lb/ft ³	Su ksf	Phi °	Unit Rs ksf	Unit Rt ksf
0.0	Sand	120.0	0.0	0.0	0.00	0.00
10.0	Sand	120.0	0.0	0.0	0.00	1.47
10.0	Sand	130.0	0.0	40.0	0.65	99.04
17.0	Sand	130.0	0.0	40.0	1.02	155.78
17.0	Sand	132.0	0.0	42.0	1.02	290.36
30.0	Sand	132.0	0.0	42.0	1.73	492.60
30.0	Sand	140.0	0.0	45.0	1.73	737.59
40.0	Sand	140.0	0.0	45.0	2.34	737.59
40.0	Sand	140.0	0.0	38.0	1.94	239.37
51.5	Sand	140.0	0.0	38.0	2.53	251.83

0 ft @ Ele. 835.0 ft amsl (831.0 ft amsl pile cap + 4.0 ft of overburden)
 Analysis Assuming 10 ft of Pre-bore to ele. 825.0 ft amsl
 Zero-friction length = 835.0-825.0 ft amsl = 10.0 ft

GRLWEAP: Wave Equation Analysis of Pile Foundations

Proposed Pedestrian Bridge + Pier 1

2/11/2025

NATIONAL ENGINEERING AND ARCHITECTURAL

GRLWEAP 14.1.20.1

ABOUT THE WAVE EQUATION ANALYSIS RESULTS

The GRLWEAP program simulates the behavior of a preformed pile driven by either an impact hammer or a vibratory hammer. The program is based on mathematical models, which describe motion and forces of hammer, driving system, pile and soil under the hammer action. Under certain conditions, the models only crudely approximate, often complex, dynamic situations.

A wave equation analysis generally relies on input data, which represents normal situations. In particular, the hammer data file supplied with the program assumes that the hammer is in good working order. All of the input data selected by the user may be the best available information at the time when the analysis is performed. However, input data and therefore results may significantly differ from actual field conditions.

Therefore, the program authors recommend prudent use of the GRLWEAP results. Soil response and hammer performance should be verified by static and/or dynamic testing and measurements. Estimates of bending or other local stresses (e.g., helmet or clamp contact, uneven rock surfaces etc.), prestress effects and others must also be accounted for by the user.

The calculated capacity-blow count relationship, i.e. the bearing graph, should be used in conjunction with observed blow counts for the capacity assessment of a driven pile. Soil setup occurring after pile installation may produce bearing capacity values that differ substantially from those expected from a wave equation analysis due to soil setup or relaxation. This is particularly true for pile driven with vibratory hammers. The GRLWEAP user must estimate such effects and should also use proper care when applying blow counts from restrike because of the variability of hammer energy, soil resistance and blow count during early restriking.

Finally, the GRLWEAP capacities are ultimate values. They MUST be reduced by means of an appropriate factor of safety to yield a design or working load. The selection of a factor of safety should consider the quality of the construction control, the variability of the site conditions, uncertainties in the loads, the importance of structure and other factors.

Proposed Pedestrian Bridge + Pile **INTERNATIONAL ENGINEERING AND ARCHITECTURAL**

HAMMER DATA

Hammer Model:	D 19-42	Made By:	DELMAG
Hammer ID:	41	Hammer Type:	OED
Hammer Database Type:	PDI		
Hammer Database Name:			PDIHammer.gwh

Hammer and Drive System Segment Data

Segment	Weight kips	Stiffness kips/in	COR	C-Slack in	Damping kips/ft/s
-			-		
1	0.800	140,084.4	1.000	0.000	
2	0.800	140,084.4	1.000	0.000	
3	0.800	140,084.4	1.000	0.000	
4	0.800	140,084.4	1.000	0.000	
5	0.800	70,754.7	0.900	0.120	
Imp Block	0.753	109,976.0	0.800	0.120	
Helmet	3.000				5.3

Ram Weight: (kips)	4.00	Ram Length: (ft)	10.76
Ram Area: (in ²)	124.69		
Maximum (Eq) Stroke: (ft)	10.81	Actual (Eq) Stroke: (ft)	10.81
Efficiency:	0.800	Rated Energy: (kip-ft)	43.24
Maximum Pressure: (psi)	1,600.00	Actual Pressure: (psi)	1,600.00
Combustion Delay: (ms)	2.00	Ignition Duration: (ms)	2.00
Expansion Exponent:	1.25		

Hammer Cushion

Pile Cushion

Cross Sect. Area: (in ²)	415.00	Cross Sect. Area: (in ²)	0.00
Elastic Modulus: (ksi)	530.0	Elastic Modulus: (ksi)	0.0
Thickness: (in)	2.00	Thickness: (in)	0.00
Coeff. of Restitution:	0.800	Coeff. of Restitution:	0.500
RoundOut: (in)	0.120	RoundOut: (in)	0.120
Stiffness: (kips/in)	109,976.0	Stiffness: (kips/in)	0.0
Helmet Weight: (kips)	3.000		

PILE INPUT

Uniform Pile		Pile Type:	Closed-End Pipe
Pile Length: (ft)	60.000	Pile Penetration: (ft)	51.600
Pile Size: (ft)	1.00	Toe Area: (in ²)	113.10

Table of Depths Analyzed with Driving System Modifiers

Depth ft	Temp Length ft	Wait Time Hr	Hammer -
5.00	55.0	0.0	DELMAG D 19-42
10.00	55.0	0.0	DELMAG D 19-42
12.50	55.0	0.0	DELMAG D 19-42
15.00	55.0	0.0	DELMAG D 19-42
17.00	55.0	0.0	DELMAG D 19-42
17.01	55.0	0.0	DELMAG D 19-42
20.00	55.0	0.0	DELMAG D 19-42
22.50	55.0	0.0	DELMAG D 19-42
25.00	55.0	0.0	DELMAG D 19-42
30.00	55.0	0.0	DELMAG D 19-42
35.00	55.0	0.0	DELMAG D 19-42
40.00	55.0	0.0	DELMAG D 19-42
45.00	55.0	0.0	DELMAG D 19-42
46.00	55.0	0.0	DELMAG D 19-42
51.60	55.0	0.0	DELMAG D 19-42

Other Information for DELMAG D 19-42

Depth ft	Stroke ft	Diesel Pressure %	Efficiency -	P.C. Stiff. Fact. -	P.C. COR -
5.00	10.8	100.0	0.80	1.0	0.50
10.00	10.8	100.0	0.80	1.0	0.50
12.50	10.8	100.0	0.80	1.0	0.50
15.00	10.8	100.0	0.80	1.0	0.50
17.00	10.8	100.0	0.80	1.0	0.50
17.01	10.8	100.0	0.80	1.0	0.50
20.00	10.8	100.0	0.80	1.0	0.50
22.50	10.8	100.0	0.80	1.0	0.50
25.00	10.8	100.0	0.80	1.0	0.50
30.00	10.8	100.0	0.80	1.0	0.50
35.00	10.8	100.0	0.80	1.0	0.50
40.00	10.8	100.0	0.80	1.0	0.50
45.00	10.8	100.0	0.80	1.0	0.50
46.00	10.8	100.0	0.80	1.0	0.50
51.60	10.8	100.0	0.80	1.0	0.50

PILE, SOIL, ANALYSIS OPTIONS

Analysis type:	Driveability Analysis	Soil Damping Option:	Smith
Max No Analysis Iterations:	0	Time Increment/Critical:	160
Residual Stress Analysis:	0	Analysis Time-Input(ms):	0
2/11/2025	3/9	GRLWEAP 14.1.20.1	

Proposed Pedestrian Bridge + Pier INTERNATIONAL ENGINEERING AND ARCHITECTURAL

Output Level:	Normal	Gravitational Acceleration (ft/s ²):	32.169
Hammer Gravity (ft/s ²):	32.169	Pile Gravity (ft/s ²):	32.169

DRIVEABILITY ANALYSIS

Analysis Depth (ft)	51.60	Standard Soil Setup	
Hammer Name	DELMAG D 19-42	Hammer ID	41
Diesel Pressure: (psi)	230.40	Stroke (ft)	10.81
Efficiency	0.80		
Shaft Gain/Loss Factor	0.571	Toe Gain/Loss Factor	1.000
Shaft Gain/Loss Factor	1.000	Toe Gain/Loss Factor	1.000

SOIL RESISTANCE PARAMETERS

Depth ft	Unit Rs ksf	Unit Rt ksf	Qs in	Qt in	Js s/ft	Jt s/ft	Setup F. -	Limit D. ft	Setup TEB Hours	Area in ²
0.00	0.0	0.0	0.10	0.133	0.200	0.1	1.8	6.00	168.0	113.10
1.67	0.0	0.2	0.10	0.133	0.200	0.1	1.8	6.00	168.0	113.10
3.33	0.0	0.5	0.10	0.133	0.200	0.1	1.8	6.00	168.0	113.10
5.00	0.0	0.7	0.10	0.133	0.200	0.1	1.8	6.00	168.0	113.10
6.67	0.0	1.0	0.10	0.133	0.200	0.1	1.8	6.00	168.0	113.10
8.33	0.0	1.2	0.10	0.133	0.200	0.1	1.8	6.00	168.0	113.10
10.00	0.0	1.5	0.10	0.133	0.200	0.1	1.8	6.00	168.0	113.10
10.00	0.6	99.0	0.10	0.100	0.100	0.1	1.2	6.00	24.0	113.10
11.75	0.7	113.2	0.10	0.100	0.100	0.1	1.2	6.00	24.0	113.10
13.50	0.8	127.4	0.10	0.100	0.100	0.1	1.2	6.00	24.0	113.10
15.25	0.9	141.6	0.10	0.100	0.100	0.1	1.2	6.00	24.0	113.10
17.00	1.0	155.8	0.10	0.100	0.100	0.1	1.2	6.00	24.0	113.10
17.00	1.0	290.4	0.10	0.108	0.050	0.1	1.0	6.00	1.0	113.10
18.86	1.1	319.3	0.10	0.108	0.050	0.1	1.0	6.00	1.0	113.10
20.71	1.2	348.1	0.10	0.108	0.050	0.1	1.0	6.00	1.0	113.10
22.57	1.3	377.0	0.10	0.108	0.050	0.1	1.0	6.00	1.0	113.10
24.43	1.4	405.9	0.10	0.108	0.050	0.1	1.0	6.00	1.0	113.10
26.29	1.5	434.8	0.10	0.108	0.050	0.1	1.0	6.00	1.0	113.10
28.14	1.6	463.7	0.10	0.108	0.050	0.1	1.0	6.00	1.0	113.10
30.00	1.7	492.6	0.10	0.108	0.050	0.1	1.0	6.00	1.0	113.10
30.00	1.7	737.6	0.10	0.100	0.100	0.1	1.2	6.00	24.0	113.10
31.67	1.8	737.6	0.10	0.100	0.100	0.1	1.2	6.00	24.0	113.10
33.33	1.9	737.6	0.10	0.100	0.100	0.1	1.2	6.00	24.0	113.10
35.00	2.0	737.6	0.10	0.100	0.100	0.1	1.2	6.00	24.0	113.10
36.67	2.1	737.6	0.10	0.100	0.100	0.1	1.2	6.00	24.0	113.10
38.33	2.2	737.6	0.10	0.100	0.100	0.1	1.2	6.00	24.0	113.10
40.00	2.3	737.6	0.10	0.100	0.100	0.1	1.2	6.00	24.0	113.10
40.00	1.9	239.4	0.10	0.102	0.100	0.1	1.5	6.00	24.0	113.10
41.64	2.0	249.6	0.10	0.102	0.100	0.1	1.5	6.00	24.0	113.10
43.29	2.1	251.8	0.10	0.102	0.100	0.1	1.5	6.00	24.0	113.10
44.93	2.2	251.8	0.10	0.102	0.100	0.1	1.5	6.00	24.0	113.10

Proposed Pedestrian Bridge + Pile FOUNDATIONAL ENGINEERING AND ARCHITECTURAL

46.57	2.3	251.8	0.10	0.102	0.100	0.1	1.5	6.00	24.0	113.10
48.21	2.4	251.8	0.10	0.102	0.100	0.1	1.5	6.00	24.0	113.10
49.86	2.4	251.8	0.10	0.102	0.100	0.1	1.5	6.00	24.0	113.10
51.60	2.5	251.8	0.10	0.102	0.100	0.1	1.5	6.00	24.0	113.10

PILE PROFILE

Lb Top ft	X-Area in ²	E-Mod ksi	Spec. Wt lb/ft ³	Perim. ft	C-Index -	Wave Sp ft/s	Impedance kips/ft/s
0.00	9.2	30,000	492.00	3.142	0	16,806.4	16.5
55.00	9.2	30,000	492.00	3.142	0	16,806.4	16.5

PILE AND SOIL MODEL Total Capacity Rut (kips): 376.854

Seg.	Weight kips	Stiffn. kips/in	C-Slk in	T-Slk in	COR -	Ru kips	Js/Jt s/ft	Qs/Qt in	LbTop ft	Perim. ft	X-Area in ²
1	0.10	7,131	0.12	0.00	0.85	0.0	0.000	0.10	3.24	3.14	9.2
2	0.10	7,131	0.00	0.00	1.00	0.0	0.000	0.10	6.47	3.14	9.2
4	0.10	7,131	0.00	0.00	1.00	0.0	0.000	0.10	12.94	3.14	9.2
5	0.10	7,131	0.00	0.00	1.00	5.2	0.100	0.10	16.18	3.14	9.2
6	0.10	7,131	0.00	0.00	1.00	7.5	0.100	0.10	19.41	3.14	9.2
7	0.10	7,131	0.00	0.00	1.00	10.2	0.064	0.10	22.65	3.14	9.2
8	0.10	7,131	0.00	0.00	1.00	12.5	0.050	0.10	25.88	3.14	9.2
9	0.10	7,131	0.00	0.00	1.00	14.3	0.050	0.10	29.12	3.14	9.2
10	0.10	7,131	0.00	0.00	1.00	16.1	0.050	0.10	32.35	3.14	9.2
11	0.10	7,131	0.00	0.00	1.00	15.9	0.084	0.10	35.59	3.14	9.2
12	0.10	7,131	0.00	0.00	1.00	16.6	0.100	0.10	38.82	3.14	9.2
13	0.10	7,131	0.00	0.00	1.00	18.3	0.100	0.10	42.06	3.14	9.2
14	0.10	7,131	0.00	0.00	1.00	16.0	0.100	0.10	45.29	3.14	9.2
15	0.10	7,131	0.00	0.00	1.00	14.4	0.100	0.10	48.53	3.14	9.2
16	0.10	7,131	0.00	0.00	1.00	15.5	0.100	0.10	51.76	3.14	9.2
17	0.10	7,131	0.00	0.00	1.00	16.6	0.100	0.10	55.00	3.14	9.2
Toe						197.8	0.149	0.10	55.00		

1.734 kips total unreduced pile weight (g = 32.169 ft/s²)

1.734 kips total reduced pile weight (g = 32.169 ft/s²)

OTHER OPTIONS

Pile Damping (%):	1	Pile Damping Fact. (kips/ft/s):	0.329
-------------------	---	---------------------------------	-------

EXTREMA TABLE at 51.6 FT; HAMMER: D 19-42

Shaft/Toe Gain/Loss Factor = 0.571/1.000

Rut = 376.9 kips

Rtoe = 197.8 kips

Time Inc. = 0.055 ms

Hammer

DELMAG D 19-42

Efficiency

0.800

Lb Top ft	Mx.T-For. kips	Mx.C-For kips	Mx.T-Str. ksi	Mx.C-Str. ksi	Mx Vel. ft/s	Mx Dis. in	ENTHRU kip-ft
3.2	0.0	453.3	0.00	49.12	16.55	1.018	24.25
6.5	9.4	459.0	1.02	49.74	16.48	0.960	23.27
9.7	18.5	461.4	2.01	50.00	16.27	0.902	22.29
12.9	26.3	463.1	2.85	50.19	15.82	0.843	21.27
16.2	33.7	463.4	3.65	50.21	15.29	0.784	19.92
19.4	33.9	459.2	3.67	49.76	14.74	0.725	18.19
22.6	30.8	453.4	3.34	49.14	14.18	0.668	16.43
25.9	26.3	444.1	2.85	48.12	13.58	0.612	14.72
29.1	19.7	428.4	2.13	46.42	12.88	0.558	13.04
32.4	10.5	410.7	1.14	44.50	12.06	0.506	11.42
35.6	0.0	393.4	0.00	42.63	11.12	0.457	9.87
38.8	0.0	376.2	0.00	40.77	10.17	0.411	8.44
42.1	0.0	357.6	0.00	38.75	9.35	0.367	7.13
45.3	0.0	333.5	0.00	36.14	8.70	0.326	5.99
48.5	0.0	311.9	0.00	33.80	8.38	0.287	5.09
51.8	0.0	296.3	0.00	32.11	7.67	0.253	4.39
55.0	0.0	280.6	0.00	30.40	5.66	0.223	3.95

Converged Stroke (ft) 9.20 Fixed Combustion Pressure (psi) 1,600.0

(Eq) Strokes Analyzed and Last Return (ft)

10.81 9.19 9.20

Shaft/Toe Gain/Loss Factor = 1.000/1.000

Rut = 417.7 kips

Rtoe = 197.8 kips

Time Inc. = 0.053 ms

Hammer

DELMAG D 19-42

Efficiency

0.800

Lb Top ft	Mx.T-For. kips	Mx.C-For kips	Mx.T-Str. ksi	Mx.C-Str. ksi	Mx Vel. ft/s	Mx Dis. in	ENTHRU kip-ft
3.2	0.0	463.3	0.00	50.21	17.11	1.021	25.23
6.5	10.0	468.7	1.09	50.79	17.03	0.961	24.16
9.7	19.9	471.4	2.15	51.08	16.78	0.900	23.06
12.9	28.9	473.9	3.13	51.35	16.26	0.838	21.94
16.2	38.0	475.7	4.12	51.54	15.64	0.775	20.40
19.4	37.2	471.5	4.03	51.09	15.08	0.712	18.39
22.6	33.1	465.8	3.59	50.48	14.51	0.650	16.38
25.9	29.3	457.5	3.18	49.58	13.88	0.591	14.52
29.1	23.3	442.7	2.53	47.97	13.12	0.533	12.75

Proposed Pedestrian Bridge + Pier INTERNATIONAL ENGINEERING AND ARCHITECTURAL

32.4	14.5	426.0	1.58	46.16	12.19	0.477	11.04
35.6	3.9	411.9	0.43	44.63	11.09	0.423	9.37
38.8	0.0	396.0	0.00	42.91	9.92	0.372	7.75
42.1	0.0	372.3	0.00	40.34	9.01	0.324	6.30
45.3	0.0	344.9	0.00	37.37	8.34	0.280	5.05
48.5	0.0	320.1	0.00	34.69	7.87	0.239	4.04
51.8	0.0	296.6	0.00	32.14	7.19	0.202	3.21
55.0	0.0	272.9	0.00	29.57	5.38	0.170	2.72

Converged Stroke (ft) 9.56 Fixed Combustion Pressure (psi) 1,600.0
 (Eq) Strokes Analyzed and Last Return (ft)
 10.81 9.62 9.56

SUMMARY TABLE at 51.6 FT; HAMMER: D 19-42

Rut	BI Ct	Stk Dn	Stk Up	Mx T-Str	LTop	Mx C-Str	LTop	ENTHRU	BI Rt	ActRes
kips	b/ft	ft	ft	ksi	ft	ksi	ft	kip-ft	b/min	kips
376.9	98.6	9.20	0.00	3.67	19.4	50.21	16.2	24.2	38.9	376.9
417.7	174.2	9.56	0.00	4.12	16.2	51.54	16.2	25.2	38.1	417.7

SUMMARY OVER DEPTHS

G/L at Shaft and Toe: 0.571/1.000

Depth ft	Rut kips	Rshaft kips	Rtoe kips	Bl Ct b/ft	Mx C-Str ksi	Mx T-Str ksi	Stroke ft	ENTHRU kip-ft	Hammer -
5.0	0.6	0.0	0.6	0.0	0.00	0.00	10.81	0.0	D 19-42
10.0	1.2	0.0	1.2	0.0	0.00	0.00	10.81	0.0	D 19-42
12.5	98.4	4.7	93.7	8.9	24.57	0.99	5.78	20.5	D 19-42
15.0	119.8	10.2	109.6	11.2	27.67	1.41	6.08	20.2	D 19-42
17.0	137.6	15.3	122.3	13.0	29.86	1.76	6.30	20.0	D 19-42
17.0	243.5	15.3	228.2	28.5	51.37	4.12	8.31	23.9	D 19-42
20.0	290.4	25.7	264.7	37.6	55.90	6.17	9.02	25.5	D 19-42
22.5	330.8	35.5	295.3	48.4	58.66	8.25	9.62	27.0	D 19-42
25.0	372.2	46.4	325.8	65.6	60.80	10.03	10.19	28.4	D 19-42
30.0	458.3	71.4	386.9	159.0	63.92	12.73	11.25	30.7	D 19-42
35.0	675.4	96.1	579.3	9,999.0	67.31	14.17	11.97	32.2	D 19-42
40.0	704.0	124.7	579.3	9,999.0	63.76	12.65	11.51	30.9	D 19-42
45.0	344.2	146.4	197.8	61.7	50.69	5.38	9.10	24.5	D 19-42
46.0	348.8	151.0	197.8	65.5	50.56	5.19	9.11	24.4	D 19-42
51.6	376.9	179.1	197.8	98.6	50.21	3.67	9.20	24.2	D 19-42

G/L at Shaft and Toe: 1.000/1.000

Depth ft	Rut kips	Rshaft kips	Rtoe kips	Bl Ct b/ft	Mx C-Str ksi	Mx T-Str ksi	Stroke ft	ENTHRU kip-ft	Hammer -
5.0	0.6	0.0	0.6	0.0	0.00	0.00	10.81	0.0	D 19-42
10.0	1.2	0.0	1.2	0.0	0.00	0.00	10.81	0.0	D 19-42
12.5	99.3	5.6	93.7	9.0	24.71	1.04	5.79	20.5	D 19-42
15.0	121.9	12.3	109.6	11.4	27.94	1.50	6.10	20.2	D 19-42
17.0	140.7	18.3	122.3	13.3	30.22	1.89	6.34	20.0	D 19-42
17.0	246.5	18.4	228.2	29.0	51.64	4.27	8.35	24.0	D 19-42
20.0	293.4	28.7	264.7	38.5	55.85	6.44	9.06	25.6	D 19-42
22.5	333.8	38.6	295.3	49.5	58.59	8.54	9.66	27.1	D 19-42
25.0	375.3	49.5	325.8	67.3	60.65	10.27	10.22	28.5	D 19-42
30.0	461.4	74.5	386.9	169.5	63.51	12.96	11.26	30.7	D 19-42
35.0	683.4	104.1	579.3	9,999.0	66.67	14.22	11.91	32.0	D 19-42
40.0	717.7	138.4	579.3	9,999.0	63.23	12.41	11.45	30.7	D 19-42
45.0	368.7	170.9	197.8	77.4	52.01	5.66	9.37	25.2	D 19-42
46.0	375.7	177.9	197.8	85.5	51.84	5.56	9.41	25.2	D 19-42
51.6	417.7	219.9	197.8	174.2	51.54	4.12	9.56	25.2	D 19-42

PIER 2

Driveability Analysis Summary
Gain/Loss Factor at Shaft/Toe = 0.556/1.000

Depth ft	Rut kips	Rshaft kips	Rtoe kips	Blow bl/ft	CtMx ksi	C-StrMx ksi	T-Str. ksi	Stroke ft	ENTHRU kip-ft	Hammer -
4.0	0.8	0.0	0.8	0.3	0.000	0.000	0.000	10.81	0.0	D 19-42
5.0	1.0	0.0	1.0	0.3	0.000	0.000	0.000	10.81	0.0	D 19-42
10.0	2.0	0.0	2.0	0.3	0.000	0.000	0.000	10.81	0.0	D 19-42
15.0	3.0	0.0	3.0	0.3	0.000	0.000	0.000	10.81	0.0	D 19-42
18.3	3.7	0.0	3.7	0.3	0.000	0.000	0.000	10.81	0.0	D 19-42
20.0	124.0	37.4	86.6	16.3	25.424	0.568	0.568	6.05	16.0	D 19-42
24.9	230.9	144.3	86.6	34.1	35.913	1.754	1.754	7.17	16.0	D 19-42
25.0	233.9	147.3	86.6	34.5	36.061	1.733	1.733	7.20	16.1	D 19-42
28.1	303.0	216.4	86.6	51.1	38.249	3.710	3.710	7.74	16.4	D 19-42
30.0	343.7	257.1	86.6	62.6	42.153	4.665	4.665	8.14	17.2	D 19-42

Total driving time: 9 minutes; Total Number of Blows: 386 (starting at penetration 4.0 ft)

0 ft @ Ele. 828.3 ft amsl (824.0 ft amsl pile cap + 4.3 ft of overburden)
 Analysis Assuming 14 ft of Pre-bore to ele. 810.0 ft amsl
 Zero-friction length = 828.3 - 810.0 ft amsl = 18.3 ft

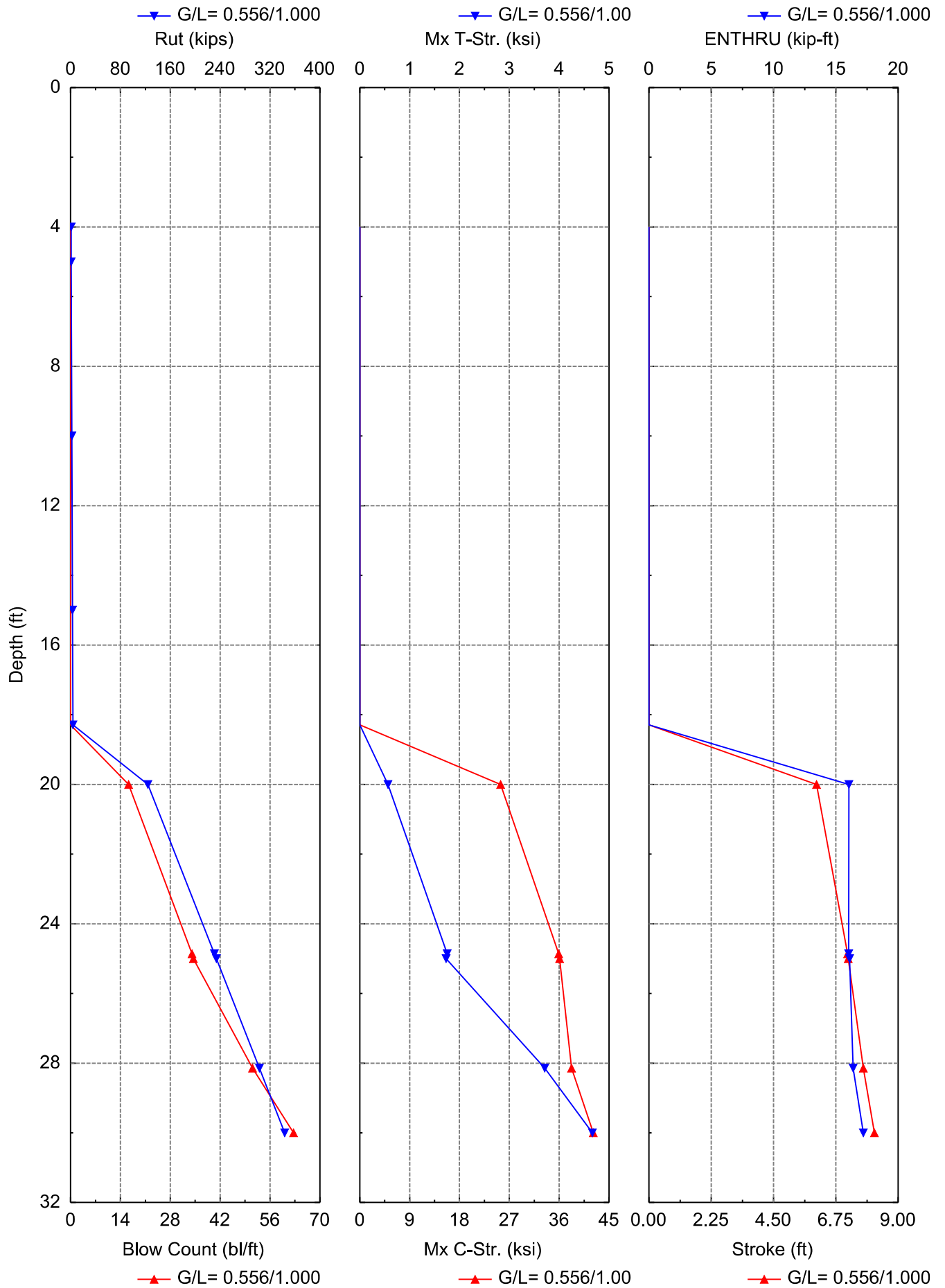

Driveability Analysis Summary
Gain/Loss Factor at Shaft/Toe = 1.000/1.000

Depth ft	Rut kips	Rshaft kips	Rtoe kips	Blow bl/ft	CtMx ksi	C-StrMx ksi	T-Str. ksi	Stroke ft	ENTHRU kip-ft	Hammer -
4.0	0.8	0.0	0.8	0.3	0.000	0.000	0.000	10.81	0.0	D 19-42
5.0	1.0	0.0	1.0	0.3	0.000	0.000	0.000	10.81	0.0	D 19-42
10.0	2.0	0.0	2.0	0.3	0.000	0.000	0.000	10.81	0.0	D 19-42
15.0	3.0	0.0	3.0	0.3	0.000	0.000	0.000	10.81	0.0	D 19-42
18.3	3.7	0.0	3.7	0.3	0.000	0.000	0.000	10.81	0.0	D 19-42
20.0	142.7	56.1	86.6	19.5	28.139	0.720	0.720	6.30	15.7	D 19-42
24.9	303.0	216.4	86.6	49.3	41.121	4.139	4.139	7.80	16.9	D 19-42
25.0	307.6	221.0	86.6	50.2	41.356	4.199	4.199	7.85	17.0	D 19-42
28.1	411.2	324.6	86.6	85.2	48.263	7.436	7.436	8.86	19.0	D 19-42
30.0	472.3	385.7	86.6	129.9	51.999	8.642	8.642	9.28	19.4	D 19-42

Total driving time: 15 minutes; Total Number of Blows: 607 (starting at penetration 4.0 ft)

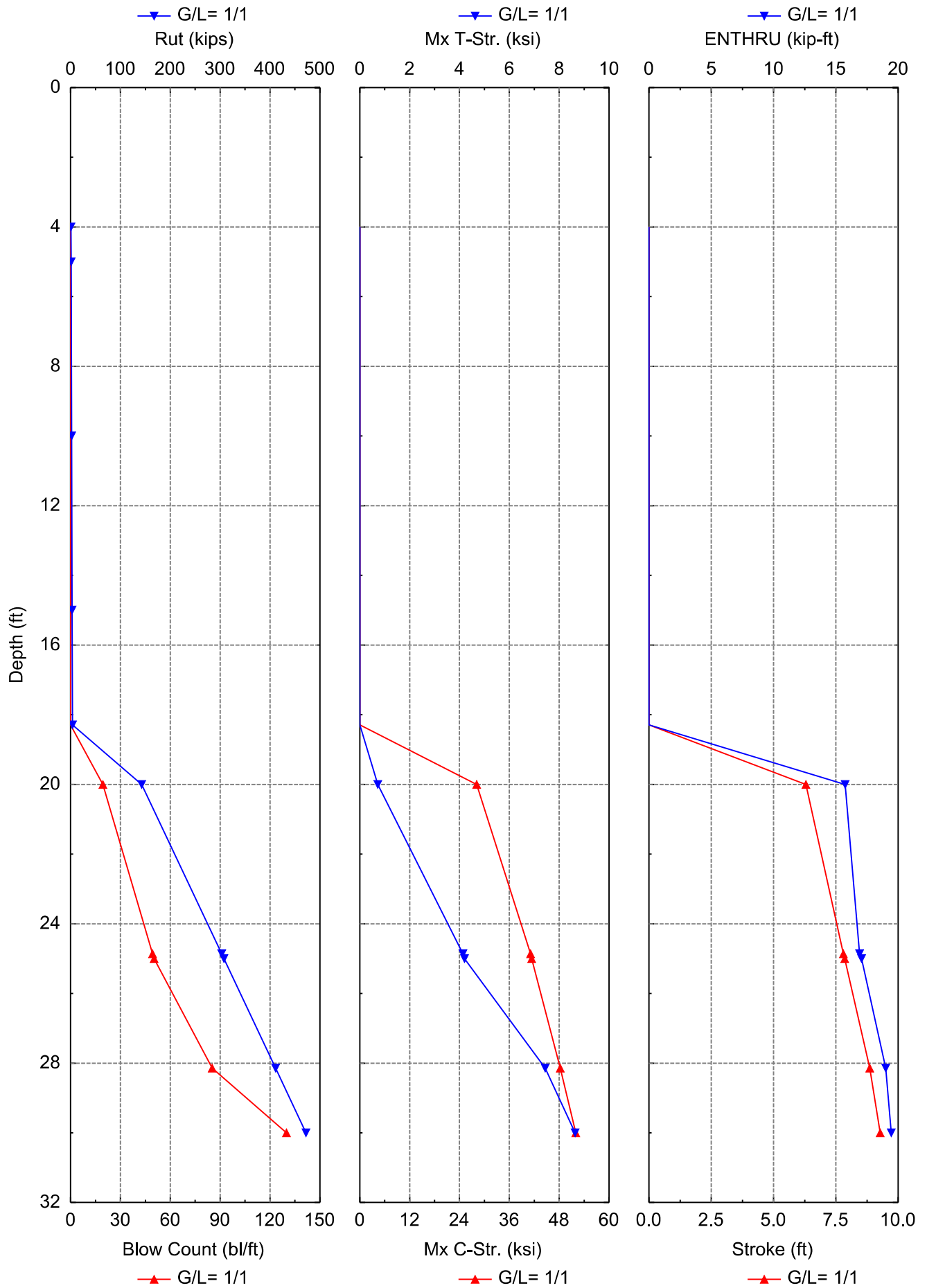

SOIL PROFILE

Depth ft	Soil Type -	Spec. Wt lb/ft ³	Su ksf	Phi °	Unit Rs ksf	Unit Rt ksf
0.0	Sand	130.0	0.0	0.0	0.00	0.00
18.3	Sand	130.0	0.0	0.0	0.00	3.45
18.3	Clay	140.0	9.0	0.0	7.39	81.00
38.3	Clay	140.0	9.0	0.0	7.39	81.00
38.3	Clay	135.0	5.9	0.0	2.87	53.10
61.5	Clay	135.0	5.9	0.0	2.87	53.10

0 ft @ Ele. 828.3 ft amsl (824.0 ft amsl pile cap + 4.3 ft of overburden)

Analysis Assuming 14 ft of Pre-bore to ele. 810.0 ft amsl

Zero-friction length = 828.3 - 810.0 ft amsl = 18.3 ft

GRLWEAP: Wave Equation Analysis of Pile Foundations

Proposed Pedestrian Bridge + Pier 2

2/12/2025

NATIONAL ENGINEERING AND ARCHITECTURAL

GRLWEAP 14.1.20.1

ABOUT THE WAVE EQUATION ANALYSIS RESULTS

The GRLWEAP program simulates the behavior of a preformed pile driven by either an impact hammer or a vibratory hammer. The program is based on mathematical models, which describe motion and forces of hammer, driving system, pile and soil under the hammer action. Under certain conditions, the models only crudely approximate, often complex, dynamic situations.

A wave equation analysis generally relies on input data, which represents normal situations. In particular, the hammer data file supplied with the program assumes that the hammer is in good working order. All of the input data selected by the user may be the best available information at the time when the analysis is performed. However, input data and therefore results may significantly differ from actual field conditions.

Therefore, the program authors recommend prudent use of the GRLWEAP results. Soil response and hammer performance should be verified by static and/or dynamic testing and measurements. Estimates of bending or other local stresses (e.g., helmet or clamp contact, uneven rock surfaces etc.), prestress effects and others must also be accounted for by the user.

The calculated capacity-blow count relationship, i.e. the bearing graph, should be used in conjunction with observed blow counts for the capacity assessment of a driven pile. Soil setup occurring after pile installation may produce bearing capacity values that differ substantially from those expected from a wave equation analysis due to soil setup or relaxation. This is particularly true for pile driven with vibratory hammers. The GRLWEAP user must estimate such effects and should also use proper care when applying blow counts from restrike because of the variability of hammer energy, soil resistance and blow count during early restriking.

Finally, the GRLWEAP capacities are ultimate values. They MUST be reduced by means of an appropriate factor of safety to yield a design or working load. The selection of a factor of safety should consider the quality of the construction control, the variability of the site conditions, uncertainties in the loads, the importance of structure and other factors.

HAMMER DATA

Hammer Model:	D 19-42	Made By:	DELMAG
Hammer ID:	41	Hammer Type:	OED
Hammer Database Type:	PDI		
Hammer Database Name:			PDIHammer.gwh

Hammer and Drive System Segment Data

Segment	Weight kips	Stiffness kips/in	COR	C-Slack in	Damping kips/ft/s
-			-		
1	0.800	140,084.4	1.000	0.000	
2	0.800	140,084.4	1.000	0.000	
3	0.800	140,084.4	1.000	0.000	
4	0.800	140,084.4	1.000	0.000	
5	0.800	70,754.7	0.900	0.120	
Imp Block	0.753	109,976.0	0.800	0.120	
Helmet	2.500				5.3

Ram Weight: (kips)	4.00	Ram Length: (ft)	10.76
Ram Area: (in ²)	124.69		
Maximum (Eq) Stroke: (ft)	10.81	Actual (Eq) Stroke: (ft)	10.81
Efficiency:	0.800	Rated Energy: (kip-ft)	43.24
Maximum Pressure: (psi)	1,600.00	Actual Pressure: (psi)	1,440.00
Combustion Delay: (ms)	2.00	Ignition Duration: (ms)	2.00
Expansion Exponent:	1.25		

Hammer Cushion

Pile Cushion

Cross Sect. Area: (in ²)	415.00	Cross Sect. Area: (in ²)	0.00
Elastic Modulus: (ksi)	530.0	Elastic Modulus: (ksi)	0.0
Thickness: (in)	2.00	Thickness: (in)	0.00
Coeff. of Restitution:	0.800	Coeff. of Restitution:	0.500
RoundOut: (in)	0.120	RoundOut: (in)	0.120
Stiffness: (kips/in)	109,976.0	Stiffness: (kips/in)	0.0
Helmet Weight: (kips)	2.500		

PILE INPUT

Uniform Pile		Pile Type:	Closed-End Pipe
Pile Length: (ft)	70.000	Pile Penetration: (ft)	30.000
Pile Size: (ft)	1.17	Toe Area: (in ²)	153.94

Table of Depths Analyzed with Driving System Modifiers

Depth ft	Temp Length ft	Wait Time Hr	Hammer -
4.00	30.0	0.0	DELMAG D 19-42
5.00	30.0	0.0	DELMAG D 19-42
10.00	30.0	0.0	DELMAG D 19-42
15.00	30.0	0.0	DELMAG D 19-42
18.29	30.0	0.0	DELMAG D 19-42
20.00	30.0	0.0	DELMAG D 19-42
24.86	30.0	0.0	DELMAG D 19-42
25.00	30.0	0.0	DELMAG D 19-42
28.14	30.0	0.0	DELMAG D 19-42
30.00	30.0	0.0	DELMAG D 19-42

Other Information for DELMAG D 19-42

Depth ft	Stroke ft	Diesel Pressure %	Efficiency -	P.C. Stiff. Fact. -	P.C. COR -
4.00	10.8	90.0	0.80	1.0	0.50
5.00	10.8	90.0	0.80	1.0	0.50
10.00	10.8	90.0	0.80	1.0	0.50
15.00	10.8	90.0	0.80	1.0	0.50
18.29	10.8	90.0	0.80	1.0	0.50
20.00	10.8	90.0	0.80	1.0	0.50
24.86	10.8	90.0	0.80	1.0	0.50
25.00	10.8	90.0	0.80	1.0	0.50
28.14	10.8	90.0	0.80	1.0	0.50
30.00	10.8	90.0	0.80	1.0	0.50

PILE, SOIL, ANALYSIS OPTIONS

Analysis type:	Driveability Analysis	Soil Damping Option:	Smith
Max No Analysis Iterations:	0	Time Increment/Critical:	160
Residual Stress Analysis:	0	Analysis Time-Input(ms):	0
Output Level:	Normal	Gravitational Acceleration (ft/s ²):	32.169
Hammer Gravity (ft/s ²):	32.169	Pile Gravity (ft/s ²):	32.169

DRIVEABILITY ANALYSIS

Analysis Depth (ft)	30.00	Standard Soil Setup	
Hammer Name	DELMAG D 19-42	Hammer ID	41
Diesel Pressure: (psi)	207.36	Stroke (ft)	10.81
Efficiency	0.80		
Shaft Gain/Loss Factor	0.556	Toe Gain/Loss Factor	1.000
Shaft Gain/Loss Factor	1.000	Toe Gain/Loss Factor	1.000

SOIL RESISTANCE PARAMETERS

Depth ft	Unit Rs ksf	Unit Rt ksf	Qs in	Qt in	Js s/ft	Jt s/ft	Setup F. -	Limit D. ft	Setup TEB Hours	Area in ²
0.00	0.0	0.0	0.10	0.115	0.200	0.1	1.8	6.00	168.0	153.94
1.66	0.0	0.3	0.10	0.115	0.200	0.1	1.8	6.00	168.0	153.94
3.33	0.0	0.6	0.10	0.115	0.200	0.1	1.8	6.00	168.0	153.94
4.99	0.0	0.9	0.10	0.115	0.200	0.1	1.8	6.00	168.0	153.94
6.65	0.0	1.3	0.10	0.115	0.200	0.1	1.8	6.00	168.0	153.94
8.32	0.0	1.6	0.10	0.115	0.200	0.1	1.8	6.00	168.0	153.94
9.98	0.0	1.9	0.10	0.115	0.200	0.1	1.8	6.00	168.0	153.94
11.65	0.0	2.2	0.10	0.115	0.200	0.1	1.8	6.00	168.0	153.94
13.31	0.0	2.5	0.10	0.115	0.200	0.1	1.8	6.00	168.0	153.94
14.97	0.0	2.8	0.10	0.115	0.200	0.1	1.8	6.00	168.0	153.94
16.64	0.0	3.1	0.10	0.115	0.200	0.1	1.8	6.00	168.0	153.94
18.30	0.0	3.4	0.10	0.115	0.200	0.1	1.8	6.00	168.0	153.94
18.30	9.0	81.0	0.10	0.100	0.150	0.1	1.5	6.00	168.0	153.94
30.00	9.0	81.0	0.10	0.100	0.150	0.1	1.5	6.00	168.0	153.94

PILE PROFILE

Lb Top ft	X-Area in ²	E-Mod ksi	Spec. Wt lb/ft ³	Perim. ft	C-Index -	Wave Sp ft/s	Impedance kips/ft/s
0.00	13.4	30,000	492.00	3.665	0	16,806.4	23.9
30.00	13.4	30,000	492.00	3.665	0	16,806.4	23.9

PILE AND SOIL MODEL Total Capacity Rut (kips): 343.703

Seg.	Weight kips	Stiffn. kips/in	C-Slk in	T-Slk in	COR -	Ru kips	Js/Jt s/ft	Qs/Qt in	LbTop ft	Perim. ft	X-Area in ²
1	0.15	10,063	0.12	0.00	0.85	0.0	0.000	0.10	3.33	3.67	13.4
2	0.15	10,063	0.00	0.00	1.00	0.0	0.000	0.10	6.67	3.67	13.4
5	0.15	10,063	0.00	0.00	1.00	0.0	0.000	0.10	16.67	3.67	13.4
6	0.15	10,063	0.00	0.00	1.00	37.4	0.150	0.10	20.00	3.67	13.4
7	0.15	10,063	0.00	0.00	1.00	73.3	0.150	0.10	23.33	3.67	13.4
9	0.15	10,063	0.00	0.00	1.00	73.3	0.150	0.10	30.00	3.67	13.4
Toe						86.6	0.149	0.10	30.00		

1.375 kips total unreduced pile weight ($g = 32.169 \text{ ft/s}^2$)

1.375 kips total reduced pile weight ($g = 32.169 \text{ ft/s}^2$)

OTHER OPTIONS

Pile Damping (%):	1	Pile Damping Fact. (kips/ft/s):	0.479
-------------------	---	---------------------------------	-------

Proposed Pedestrian Bridge + Pier INTERNATIONAL ENGINEERING AND ARCHITECTURAL

EXTREMA TABLE at 30.0 FT; HAMMER: D 19-42

Shaft/Toe Gain/Loss Factor = 0.556/1.000

Rut = 343.7 kips Rtoe = 86.6 kips Time Inc. = 0.076 ms

Hammer DELMAG D 19-42 Efficiency 0.800

Lb Top ft	Mx.T-For. kips	Mx.C-For kips	Mx.T-Str. ksi	Mx.C-Str. ksi	Mx Vel. ft/s	Mx Dis. in	ENTHRU kip-ft
3.3	0.0	530.1	0.00	39.51	15.20	0.582	17.21
6.7	18.0	544.7	1.34	40.60	15.09	0.538	16.39
10.0	33.3	565.5	2.49	42.15	14.90	0.492	15.53
13.3	45.5	562.6	3.39	41.93	14.42	0.447	14.68
16.7	54.8	554.5	4.09	41.33	13.31	0.403	13.88
20.0	62.6	561.7	4.67	41.86	11.12	0.362	12.24
23.3	38.6	507.5	2.88	37.83	9.16	0.331	9.40
26.7	11.0	390.1	0.82	29.07	8.41	0.308	6.40
30.0	0.1	269.0	0.00	20.05	7.76	0.292	5.02

Converged Stroke (ft) 8.14 Fixed Combustion Pressure (psi) 1,440.0

(Eq) Strokes Analyzed and Last Return (ft)

10.81 8.03 8.14 8.14

Shaft/Toe Gain/Loss Factor = 1.000/1.000

Rut = 472.3 kips Rtoe = 86.6 kips Time Inc. = 0.075 ms

Hammer DELMAG D 19-42 Efficiency 0.800

Lb Top ft	Mx.T-For. kips	Mx.C-For kips	Mx.T-Str. ksi	Mx.C-Str. ksi	Mx Vel. ft/s	Mx Dis. in	ENTHRU kip-ft
3.3	0.0	643.6	0.00	47.97	16.74	0.586	19.43
6.7	27.7	673.7	2.07	50.22	16.56	0.530	18.14
10.0	51.7	687.7	3.85	51.26	16.36	0.471	16.67
13.3	76.1	681.4	5.67	50.79	15.78	0.410	15.11
16.7	99.4	680.9	7.41	50.75	14.38	0.350	13.59
20.0	115.9	697.6	8.64	52.00	11.37	0.293	11.11
23.3	62.1	622.4	4.63	46.39	8.66	0.245	7.57
26.7	9.6	460.3	0.72	34.31	7.51	0.212	4.53
30.0	0.0	297.2	0.00	22.15	6.93	0.192	3.27

Converged Stroke (ft) 9.28 Fixed Combustion Pressure (psi) 1,440.0

(Eq) Strokes Analyzed and Last Return (ft)

10.81 9.38 9.29 9.28

SUMMARY TABLE at 30.0 FT; HAMMER: D 19-42

Rut kips	BI Ct b/ft	Stk Dn ft	Stk Up ft	Mx T-Str ksi	LTop ft	Mx C-Str ksi	LTop ft	ENTHRU kip-ft	BI Rt b/min	ActRes kips
-------------	---------------	--------------	--------------	-----------------	------------	-----------------	------------	------------------	----------------	----------------

Proposed Pedestrian Bridge + Pier INTERNATIONAL ENGINEERING AND ARCHITECTURAL

343.7	62.6	8.14	0.00	4.67	20.0	42.15	10.0	17.2	41.4	343.7
472.3	129.9	9.28	0.00	8.64	20.0	52.00	20.0	19.4	38.9	472.3

SUMMARY OVER DEPTHS

G/L at Shaft and Toe: 0.556/1.000

Depth ft	Rut kips	Rshaft kips	Rtoe kips	Bl Ct b/ft	Mx C-Str ksi	Mx T-Str ksi	Stroke ft	ENTHRU kip-ft	Hammer -
4.0	0.8	0.0	0.8	0.0	0.00	0.00	10.81	0.0	D 19-42
5.0	1.0	0.0	1.0	0.0	0.00	0.00	10.81	0.0	D 19-42
10.0	2.0	0.0	2.0	0.0	0.00	0.00	10.81	0.0	D 19-42
15.0	3.0	0.0	3.0	0.0	0.00	0.00	10.81	0.0	D 19-42
18.3	3.7	0.0	3.7	0.0	0.00	0.00	10.81	0.0	D 19-42
20.0	124.0	37.4	86.6	16.3	25.42	0.57	6.05	16.0	D 19-42
24.9	230.9	144.3	86.6	34.1	35.91	1.75	7.17	16.0	D 19-42
25.0	233.9	147.3	86.6	34.5	36.06	1.73	7.20	16.1	D 19-42
28.1	303.0	216.4	86.6	51.1	38.25	3.71	7.74	16.4	D 19-42
30.0	343.7	257.1	86.6	62.6	42.15	4.67	8.14	17.2	D 19-42

G/L at Shaft and Toe: 1.000/1.000

Depth ft	Rut kips	Rshaft kips	Rtoe kips	Bl Ct b/ft	Mx C-Str ksi	Mx T-Str ksi	Stroke ft	ENTHRU kip-ft	Hammer -
4.0	0.8	0.0	0.8	0.0	0.00	0.00	10.81	0.0	D 19-42
5.0	1.0	0.0	1.0	0.0	0.00	0.00	10.81	0.0	D 19-42
10.0	2.0	0.0	2.0	0.0	0.00	0.00	10.81	0.0	D 19-42
15.0	3.0	0.0	3.0	0.0	0.00	0.00	10.81	0.0	D 19-42
18.3	3.7	0.0	3.7	0.0	0.00	0.00	10.81	0.0	D 19-42
20.0	142.7	56.1	86.6	19.5	28.14	0.72	6.30	15.7	D 19-42
24.9	303.0	216.4	86.6	49.3	41.12	4.14	7.80	16.9	D 19-42
25.0	307.6	221.0	86.6	50.2	41.36	4.20	7.85	17.0	D 19-42
28.1	411.2	324.6	86.6	85.2	48.26	7.44	8.86	19.0	D 19-42
30.0	472.3	385.7	86.6	129.9	52.00	8.64	9.28	19.4	D 19-42

PIER 3

Driveability Analysis Summary
Gain/Loss Factor at Shaft/Toe = 0.571/1.000

Depth ft	Rut kips	Rshaft kips	Rtoe kips	Blow bl/ft	CtMx ksi	C-StrMx ksi	T-Str. ksi	Stroke ft	ENTHRU kip-ft	Hammer -
5.0	0.5	0.0	0.5	0.3	0.000	0.000	0.000	10.81	0.0	D 19-42
10.0	1.1	0.0	1.1	0.3	0.000	0.000	0.000	10.81	0.0	D 19-42
14.0	1.5	0.0	1.5	0.3	0.000	0.000	0.000	10.81	0.0	D 19-42
14.1	1.5	0.0	1.5	0.3	0.000	0.000	0.000	10.81	0.0	D 19-42
14.1	330.0	0.0	329.9	51.1	47.854	5.968	8.61	21.3	21.3	D 19-42
15.0	359.1	3.0	356.2	60.7	49.912	6.774	8.96	22.0	22.0	D 19-42
20.0	114.1	40.5	73.6	13.7	23.102	1.398	5.79	16.6	16.6	D 19-42
25.0	207.6	134.0	73.6	27.5	31.061	3.804	6.81	17.3	17.3	D 19-42
30.0	301.0	227.4	73.6	47.9	35.369	7.431	7.93	19.2	19.2	D 19-42
35.0	861.5	285.5	576.0	9999.0	46.862	12.033	10.91	25.6	25.6	D 19-42
40.0	961.4	327.5	633.9	9999.0	47.879	11.489	10.54	24.8	24.8	D 19-42
45.0	1009.6	375.7	633.9	9999.0	47.429	10.367	10.07	23.3	23.3	D 19-42
50.3	1067.6	433.7	633.9	9999.0	46.981	8.192	9.75	22.0	22.0	D 19-42

Refusal occurred; no driving time output possible.

0 ft @ Ele. 826.8 ft amsl (822.8 ft amsl pile cap + 4.0 ft of overburden)

Analysis Assuming 10.1 ft of Pre-bore to ele. 812.65 ft amsl

Zero-friction length = 826.8 - 812.7 ft amsl = 14.1 ft

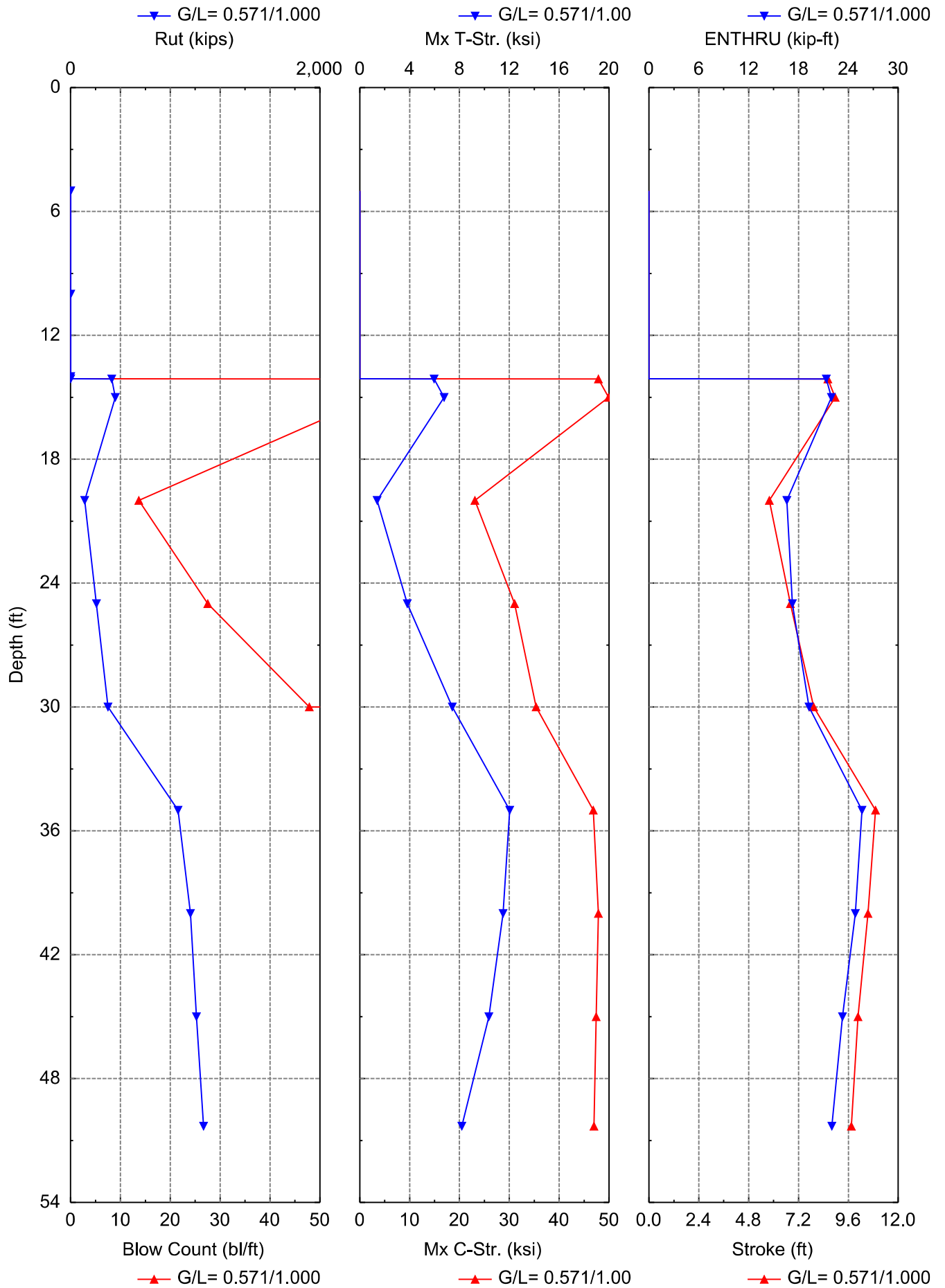

Driveability Analysis Summary
Gain/Loss Factor at Shaft/Toe = 1.000/1.000

Depth ft	Rut kips	Rshaft kips	Rtoe kips	Blow bl/ft	CtMx ksi	C-StrMx ksi	T-Str. ksi	Stroke ft	ENTHRU kip-ft	Hammer -
5.0	0.5	0.0	0.5	0.3	0.000	0.000	0.000	10.81	0.0	D 19-42
10.0	1.1	0.0	1.1	0.3	0.000	0.000	0.000	10.81	0.0	D 19-42
14.0	1.5	0.0	1.5	0.3	0.000	0.000	0.000	10.81	0.0	D 19-42
14.1	1.5	0.0	1.5	0.3	0.000	0.000	0.000	10.81	0.0	D 19-42
14.1	330.0	0.0	329.9	51.1	47.854	5.968	5.968	8.61	21.3	D 19-42
15.0	359.1	3.0	356.2	60.7	49.912	6.774	6.774	8.96	22.0	D 19-42
20.0	125.3	51.7	73.6	15.3	23.984	1.669	1.669	5.92	16.5	D 19-42
25.0	265.5	191.9	73.6	37.7	36.397	6.032	6.032	7.53	18.7	D 19-42
30.0	405.7	332.1	73.6	98.3	41.564	11.121	11.121	9.04	21.6	D 19-42
35.0	991.3	415.4	576.0	9999.0	50.081	13.343	13.343	11.10	25.9	D 19-42
40.0	1099.6	465.7	633.9	9999.0	51.128	12.874	12.874	10.78	25.1	D 19-42
45.0	1157.5	523.6	633.9	9999.0	51.345	12.240	12.240	10.49	24.1	D 19-42
50.3	1227.0	593.2	633.9	9999.0	51.186	9.857	9.857	10.25	22.8	D 19-42

Refusal occurred; no driving time output possible.

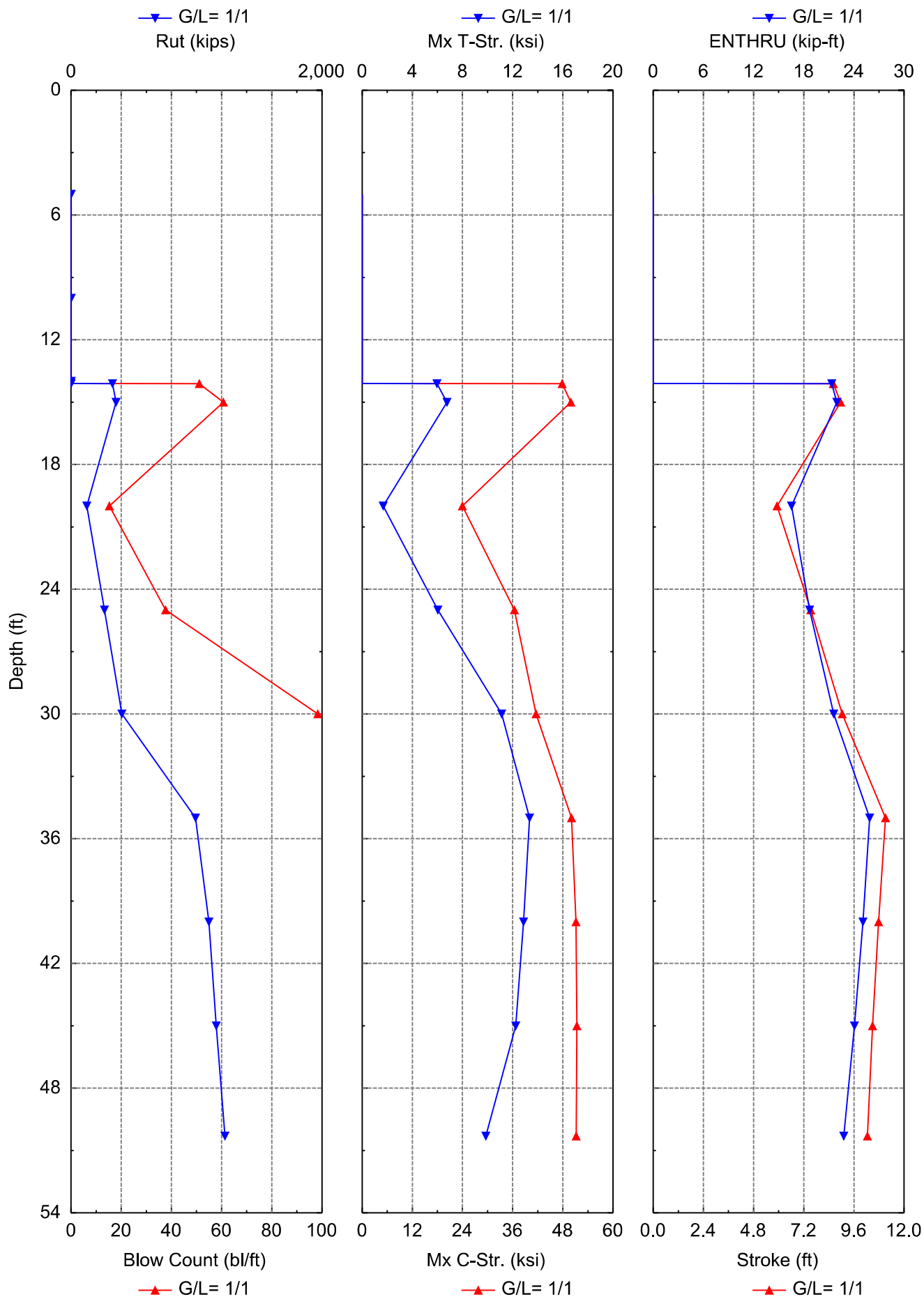

SOIL PROFILE

Depth ft	Soil Type -	Spec. Wt lb/ft ³	Su ksf	Phi °	Unit Rs ksf	Unit Rt ksf
0.0	Sand	120.0	0.0	0.0	0.00	0.00
14.1	Sand	120.0	0.0	0.0	0.00	1.44
14.1	Sand	135.0	0.0	45.0	0.87	308.36
18.8	Sand	135.0	0.0	45.0	1.23	437.93
18.8	Clay	140.0	7.6	0.0	7.19	68.85
33.3	Clay	140.0	7.6	0.0	7.19	68.85
33.3	Sand	140.0	0.0	42.0	2.40	509.29
50.3	Sand	140.0	0.0	42.0	3.80	592.96

0 ft @ Ele. 826.8 ft amsl (822.8 ft amsl pile cap + 4.0 ft of overburden)
 Analysis Assuming 10.1 ft of Pre-bore to ele. 812.65 ft amsl
 Zero-friction length = 826.8 - 812.7 ft amsl = 14.1 ft

GRLWEAP: Wave Equation Analysis of Pile Foundations

Proposed Pedestrian Bridge + Pier 3

2/11/2025

NATIONAL ENGINEERING AND ARCHITECTURAL

GRLWEAP 14.1.20.1

ABOUT THE WAVE EQUATION ANALYSIS RESULTS

The GRLWEAP program simulates the behavior of a preformed pile driven by either an impact hammer or a vibratory hammer. The program is based on mathematical models, which describe motion and forces of hammer, driving system, pile and soil under the hammer action. Under certain conditions, the models only crudely approximate, often complex, dynamic situations.

A wave equation analysis generally relies on input data, which represents normal situations. In particular, the hammer data file supplied with the program assumes that the hammer is in good working order. All of the input data selected by the user may be the best available information at the time when the analysis is performed. However, input data and therefore results may significantly differ from actual field conditions.

Therefore, the program authors recommend prudent use of the GRLWEAP results. Soil response and hammer performance should be verified by static and/or dynamic testing and measurements. Estimates of bending or other local stresses (e.g., helmet or clamp contact, uneven rock surfaces etc.), prestress effects and others must also be accounted for by the user.

The calculated capacity-blow count relationship, i.e. the bearing graph, should be used in conjunction with observed blow counts for the capacity assessment of a driven pile. Soil setup occurring after pile installation may produce bearing capacity values that differ substantially from those expected from a wave equation analysis due to soil setup or relaxation. This is particularly true for pile driven with vibratory hammers. The GRLWEAP user must estimate such effects and should also use proper care when applying blow counts from restrike because of the variability of hammer energy, soil resistance and blow count during early restriking.

Finally, the GRLWEAP capacities are ultimate values. They MUST be reduced by means of an appropriate factor of safety to yield a design or working load. The selection of a factor of safety should consider the quality of the construction control, the variability of the site conditions, uncertainties in the loads, the importance of structure and other factors.

Proposed Pedestrian Bridge + Pile
 NATIONAL ENGINEERING AND ARCHITECTURAL

HAMMER DATA

Hammer Model:	D 19-42	Made By:	DELMAG
Hammer ID:	41	Hammer Type:	OED
Hammer Database Type:	PDI		
Hammer Database Name:			PDIHammer.gwh

Hammer and Drive System Segment Data

Segment	Weight kips	Stiffness kips/in	COR	C-Slack in	Damping kips/ft/s
-			-		
1	0.800	140,084.4	1.000	0.000	
2	0.800	140,084.4	1.000	0.000	
3	0.800	140,084.4	1.000	0.000	
4	0.800	140,084.4	1.000	0.000	
5	0.800	70,754.7	0.900	0.120	
Imp Block	0.753	109,976.0	0.800	0.120	
Helmet	2.500				5.3

Ram Weight: (kips)	4.00	Ram Length: (ft)	10.76
Ram Area: (in ²)	124.69		
Maximum (Eq) Stroke: (ft)	10.81	Actual (Eq) Stroke: (ft)	10.81
Efficiency:	0.800	Rated Energy: (kip-ft)	43.24
Maximum Pressure: (psi)	1,600.00	Actual Pressure: (psi)	1,440.00
Combustion Delay: (ms)	2.00	Ignition Duration: (ms)	2.00
Expansion Exponent:	1.25		

Hammer Cushion

Pile Cushion

Cross Sect. Area: (in ²)	415.00	Cross Sect. Area: (in ²)	0.00
Elastic Modulus: (ksi)	530.0	Elastic Modulus: (ksi)	0.0
Thickness: (in)	2.00	Thickness: (in)	0.00
Coeff. of Restitution:	0.800	Coeff. of Restitution:	0.500
RoundOut: (in)	0.120	RoundOut: (in)	0.120
Stiffness: (kips/in)	109,976.0	Stiffness: (kips/in)	0.0
Helmet Weight: (kips)	2.500		

PILE INPUT

Uniform Pile		Pile Type:	Closed-End Pipe
Pile Length: (ft)	60.000	Pile Penetration: (ft)	50.300
Pile Size: (ft)	1.17	Toe Area: (in ²)	153.94

Table of Depths Analyzed with Driving System Modifiers

Depth ft	Temp Length ft	Wait Time Hr	Hammer -
5.00	55.0	0.0	DELMAG D 19-42
10.00	55.0	0.0	DELMAG D 19-42
14.00	55.0	0.0	DELMAG D 19-42
14.10	55.0	0.0	DELMAG D 19-42
14.11	55.0	0.0	DELMAG D 19-42
15.00	55.0	0.0	DELMAG D 19-42
20.00	55.0	0.0	DELMAG D 19-42
25.00	55.0	0.0	DELMAG D 19-42
30.00	55.0	0.0	DELMAG D 19-42
35.00	55.0	0.0	DELMAG D 19-42
40.00	55.0	0.0	DELMAG D 19-42
45.00	55.0	0.0	DELMAG D 19-42
50.30	55.0	0.0	DELMAG D 19-42

Other Information for DELMAG D 19-42

Depth ft	Stroke ft	Diesel Pressure %	Efficiency -	P.C. Stiff. Fact. -	P.C. COR -
5.00	10.8	90.0	0.80	1.0	0.50
10.00	10.8	90.0	0.80	1.0	0.50
14.00	10.8	90.0	0.80	1.0	0.50
14.10	10.8	90.0	0.80	1.0	0.50
14.11	10.8	90.0	0.80	1.0	0.50
15.00	10.8	90.0	0.80	1.0	0.50
20.00	10.8	90.0	0.80	1.0	0.50
25.00	10.8	90.0	0.80	1.0	0.50
30.00	10.8	90.0	0.80	1.0	0.50
35.00	10.8	90.0	0.80	1.0	0.50
40.00	10.8	90.0	0.80	1.0	0.50
45.00	10.8	90.0	0.80	1.0	0.50
50.30	10.8	90.0	0.80	1.0	0.50

PILE, SOIL, ANALYSIS OPTIONS

Analysis type:	Driveability Analysis	Soil Damping Option:	Smith
Max No Analysis Iterations:	0	Time Increment/Critical:	160
Residual Stress Analysis:	0	Analysis Time-Input(ms):	0
Output Level:	Normal	Gravitational Acceleration (ft/s ²):	32.169
Hammer Gravity (ft/s ²):	32.169	Pile Gravity (ft/s ²):	32.169

DRIVEABILITY ANALYSIS

Analysis Depth (ft)	50.30	Standard Soil Setup	
Hammer Name	DELMAG D 19-42	Hammer ID	41
Diesel Pressure: (psi)	207.36	Stroke (ft)	10.81
Efficiency	0.80		
Shaft Gain/Loss Factor	0.571	Toe Gain/Loss Factor	1.000
Shaft Gain/Loss Factor	1.000	Toe Gain/Loss Factor	1.000

SOIL RESISTANCE PARAMETERS

Depth ft	Unit Rs ksf	Unit Rt ksf	Qs in	Qt in	Js s/ft	Jt s/ft	Setup F. -	Limit D. ft	Setup TEB Hours	Area in ²
0.00	0.0	0.0	0.10	0.133	0.200	0.1	1.8	6.00	168.0	153.94
1.76	0.0	0.2	0.10	0.133	0.200	0.1	1.8	6.00	168.0	153.94
3.53	0.0	0.4	0.10	0.133	0.200	0.1	1.8	6.00	168.0	153.94
5.29	0.0	0.5	0.10	0.133	0.200	0.1	1.8	6.00	168.0	153.94
7.05	0.0	0.7	0.10	0.133	0.200	0.1	1.8	6.00	168.0	153.94
8.81	0.0	0.9	0.10	0.133	0.200	0.1	1.8	6.00	168.0	153.94
10.58	0.0	1.1	0.10	0.133	0.200	0.1	1.8	6.00	168.0	153.94
12.34	0.0	1.3	0.10	0.133	0.200	0.1	1.8	6.00	168.0	153.94
14.10	0.0	1.4	0.10	0.133	0.200	0.1	1.8	6.00	168.0	153.94
14.10	0.9	308.4	0.10	0.100	0.050	0.1	1.0	6.00	1.0	153.94
16.45	1.0	373.1	0.10	0.100	0.050	0.1	1.0	6.00	1.0	153.94
18.80	1.2	437.9	0.10	0.100	0.050	0.1	1.0	6.00	1.0	153.94
18.80	7.2	68.8	0.10	0.100	0.150	0.1	1.5	6.00	168.0	153.94
33.30	7.2	68.8	0.10	0.100	0.150	0.1	1.5	6.00	168.0	153.94
33.30	2.4	509.3	0.10	0.100	0.100	0.1	1.2	6.00	24.0	153.94
35.00	2.5	538.8	0.10	0.100	0.100	0.1	1.2	6.00	24.0	153.94
36.70	2.7	568.3	0.10	0.100	0.100	0.1	1.2	6.00	24.0	153.94
38.40	2.8	593.0	0.10	0.100	0.100	0.1	1.2	6.00	24.0	153.94
40.10	3.0	593.0	0.10	0.100	0.100	0.1	1.2	6.00	24.0	153.94
41.80	3.1	593.0	0.10	0.100	0.100	0.1	1.2	6.00	24.0	153.94
43.50	3.2	593.0	0.10	0.100	0.100	0.1	1.2	6.00	24.0	153.94
45.20	3.4	593.0	0.10	0.100	0.100	0.1	1.2	6.00	24.0	153.94
46.90	3.5	593.0	0.10	0.100	0.100	0.1	1.2	6.00	24.0	153.94
48.60	3.7	593.0	0.10	0.100	0.100	0.1	1.2	6.00	24.0	153.94
50.30	3.8	593.0	0.10	0.100	0.100	0.1	1.2	6.00	24.0	153.94

PILE PROFILE

Lb Top ft	X-Area in ²	E-Mod ksi	Spec. Wt lb/ft ³	Perim. ft	C-Index -	Wave Sp ft/s	Impedance kips/ft/s
0.00	13.4	30,000	492.00	3.665	0	16,806.4	23.9
55.00	13.4	30,000	492.00	3.665	0	16,806.4	23.9

PILE AND SOIL MODEL											Total Capacity Rut (kips):	1067.553
Seg.	Weight kips	Stiffn. kips/in	C-Slk in	T-Slk in	COR	Ru kips	Js/Jt s/ft	Qs/Qt in	LbTop ft	Perim. ft	X-Area in ²	
1	0.15	10,368	0.12	0.00	0.85	0.0	0.000	0.10	3.24	3.67	13.4	
2	0.15	10,368	0.00	0.00	1.00	0.0	0.000	0.10	6.47	3.67	13.4	
5	0.15	10,368	0.00	0.00	1.00	0.0	0.000	0.10	16.18	3.67	13.4	
6	0.15	10,368	0.00	0.00	1.00	2.0	0.050	0.10	19.41	3.67	13.4	
7	0.15	10,368	0.00	0.00	1.00	12.3	0.050	0.10	22.65	3.67	13.4	
8	0.15	10,368	0.00	0.00	1.00	45.6	0.144	0.10	25.88	3.67	13.4	
9	0.15	10,368	0.00	0.00	1.00	56.8	0.150	0.10	29.12	3.67	13.4	
11	0.15	10,368	0.00	0.00	1.00	56.8	0.150	0.10	35.59	3.67	13.4	
12	0.15	10,368	0.00	0.00	1.00	48.5	0.145	0.10	38.82	3.67	13.4	
13	0.15	10,368	0.00	0.00	1.00	25.7	0.100	0.10	42.06	3.67	13.4	
14	0.15	10,368	0.00	0.00	1.00	28.4	0.100	0.10	45.29	3.67	13.4	
15	0.15	10,368	0.00	0.00	1.00	31.0	0.100	0.10	48.53	3.67	13.4	
16	0.15	10,368	0.00	0.00	1.00	33.6	0.100	0.10	51.76	3.67	13.4	
17	0.15	10,368	0.00	0.00	1.00	36.2	0.100	0.10	55.00	3.67	13.4	
Toe						633.9	0.149	0.10	55.00			

2.521 kips total unreduced pile weight (g = 32.169 ft/s²)

2.521 kips total reduced pile weight (g = 32.169 ft/s²)

OTHER OPTIONS

Pile Damping (%):	1	Pile Damping Fact. (kips/ft/s):	0.479
-------------------	---	---------------------------------	-------

EXTREMA TABLE at 50.3 FT; HAMMER: D 19-42

Shaft/Toe Gain/Loss Factor = 0.571/1.000

Rut = 1,067.6 kips Rtoe = 633.9 kips Time Inc. = 0.028 ms
 Hammer DELMAG D 19-42 Efficiency 0.800

Lb Top ft	Mx.T-For. kips	Mx.C-For kips	Mx.T-Str. ksi	Mx.C-Str. ksi	Mx Vel. ft/s	Mx Dis. in	ENTHRU kip-ft
3.2	0.0	573.4	0.00	42.74	17.60	0.701	22.00
6.5	23.4	574.6	1.74	42.83	17.51	0.654	21.07
9.7	44.0	574.2	3.28	42.79	17.38	0.605	20.01
12.9	64.3	581.6	4.79	43.35	17.20	0.552	18.81
16.2	83.4	604.6	6.21	45.06	16.82	0.496	17.45
19.4	99.3	626.1	7.40	46.67	16.04	0.438	16.00
22.6	109.9	630.3	8.19	46.98	14.58	0.381	14.30
25.9	107.1	617.6	7.99	46.04	12.03	0.325	11.65
29.1	62.6	562.0	4.66	41.89	9.95	0.275	8.50
32.4	3.5	492.7	0.26	36.72	8.41	0.231	5.95
35.6	0.0	425.4	0.00	31.71	7.28	0.193	4.05
38.8	0.0	356.0	0.00	26.54	6.55	0.160	2.70
42.1	0.0	307.2	0.00	22.90	6.19	0.131	1.88
45.3	0.0	289.0	0.00	21.54	5.83	0.104	1.35
48.5	0.0	265.3	0.00	19.77	5.45	0.078	0.94
51.8	0.0	243.3	0.00	18.13	4.71	0.055	0.62
55.0	0.0	225.7	0.00	16.82	2.88	0.034	0.39

Converged Stroke (ft) 9.75 Fixed Combustion Pressure (psi) 1,440.0
 (Eq) Strokes Analyzed and Last Return (ft)
 10.81 9.95 9.78 9.75

Shaft/Toe Gain/Loss Factor = 1.000/1.000

Rut = 1,227.0 kips Rtoe = 633.9 kips Time Inc. = 0.028 ms
 Hammer DELMAG D 19-42 Efficiency 0.800

Lb Top ft	Mx.T-For. kips	Mx.C-For kips	Mx.T-Str. ksi	Mx.C-Str. ksi	Mx Vel. ft/s	Mx Dis. in	ENTHRU kip-ft
3.2	0.0	640.2	0.00	47.72	18.22	0.690	22.78
6.5	34.7	648.8	2.59	48.36	18.11	0.637	21.58
9.7	60.7	655.5	4.52	48.85	17.98	0.582	20.29
12.9	82.8	659.4	6.17	49.15	17.78	0.524	18.82
16.2	100.2	660.6	7.47	49.23	17.37	0.462	17.18
19.4	118.8	682.2	8.85	50.85	16.50	0.399	15.40
22.6	132.2	686.7	9.86	51.19	14.72	0.335	13.41
25.9	130.7	680.1	9.74	50.69	11.48	0.273	10.33
29.1	62.4	605.4	4.65	45.12	8.97	0.219	6.80

Proposed Pedestrian Bridge + Pier INTERNATIONAL ENGINEERING AND ARCHITECTURAL

32.4	0.0	501.8	0.00	37.40	7.25	0.175	4.21
35.6	0.0	398.9	0.00	29.73	6.04	0.139	2.52
38.8	0.0	294.7	0.00	21.97	5.30	0.112	1.48
42.1	0.0	222.5	0.00	16.59	5.00	0.091	0.95
45.3	0.0	202.8	0.00	15.11	4.69	0.071	0.67
48.5	0.0	184.4	0.00	13.74	4.38	0.054	0.46
51.8	0.0	166.8	0.00	12.43	3.87	0.038	0.30
55.0	0.0	153.4	0.00	11.44	2.47	0.024	0.20

Converged Stroke (ft) 10.25 Fixed Combustion Pressure (psi) 1,440.0
 (Eq) Strokes Analyzed and Last Return (ft)
 10.81 10.38 10.27 10.25

SUMMARY TABLE at 50.3 FT; HAMMER: D 19-42

Rut	BI Ct	Stk Dn	Stk Up	Mx T-Str	LTop	Mx C-Str	LTop	ENTHRU	BI Rt	ActRes
kips	b/ft	ft	ft	ksi	ft	ksi	ft	kip-ft	b/min	kips
1,067.6	9,999	9.75	0.00	8.19	22.6	46.98	22.6	22.0	37.9	600.5
1,227.0	9,999	10.25	0.00	9.86	22.6	51.19	22.6	22.8	37.0	657.9

SUMMARY OVER DEPTHS

G/L at Shaft and Toe: 0.571/1.000

Depth ft	Rut kips	Rshaft kips	Rtoe kips	Bl Ct b/ft	Mx C-Str ksi	Mx T-Str ksi	Stroke ft	ENTHRU kip-ft	Hammer -
5.0	0.5	0.0	0.5	0.0	0.00	0.00	10.81	0.0	D 19-42
10.0	1.1	0.0	1.1	0.0	0.00	0.00	10.81	0.0	D 19-42
14.0	1.5	0.0	1.5	0.0	0.00	0.00	10.81	0.0	D 19-42
14.1	1.5	0.0	1.5	0.0	0.00	0.00	10.81	0.0	D 19-42
14.1	330.0	0.0	329.9	51.1	47.85	5.97	8.61	21.3	D 19-42
15.0	359.1	3.0	356.2	60.7	49.91	6.77	8.96	22.0	D 19-42
20.0	114.1	40.5	73.6	13.7	23.10	1.40	5.79	16.6	D 19-42
25.0	207.6	134.0	73.6	27.5	31.06	3.80	6.81	17.3	D 19-42
30.0	301.0	227.4	73.6	47.9	35.37	7.43	7.93	19.2	D 19-42
35.0	861.5	285.5	576.0	9,999.0	46.86	12.03	10.91	25.6	D 19-42
40.0	961.4	327.5	633.9	9,999.0	47.88	11.49	10.54	24.8	D 19-42
45.0	1,009.6	375.7	633.9	9,999.0	47.43	10.37	10.07	23.3	D 19-42
50.3	1,067.6	433.7	633.9	9,999.0	46.98	8.19	9.75	22.0	D 19-42

G/L at Shaft and Toe: 1.000/1.000

Depth ft	Rut kips	Rshaft kips	Rtoe kips	Bl Ct b/ft	Mx C-Str ksi	Mx T-Str ksi	Stroke ft	ENTHRU kip-ft	Hammer -
5.0	0.5	0.0	0.5	0.0	0.00	0.00	10.81	0.0	D 19-42
10.0	1.1	0.0	1.1	0.0	0.00	0.00	10.81	0.0	D 19-42
14.0	1.5	0.0	1.5	0.0	0.00	0.00	10.81	0.0	D 19-42
14.1	1.5	0.0	1.5	0.0	0.00	0.00	10.81	0.0	D 19-42
14.1	330.0	0.0	329.9	51.1	47.85	5.97	8.61	21.3	D 19-42
15.0	359.1	3.0	356.2	60.7	49.91	6.77	8.96	22.0	D 19-42
20.0	125.3	51.7	73.6	15.3	23.98	1.67	5.92	16.5	D 19-42
25.0	265.5	191.9	73.6	37.7	36.40	6.03	7.53	18.7	D 19-42
30.0	405.7	332.1	73.6	98.3	41.56	11.12	9.04	21.6	D 19-42
35.0	991.3	415.4	576.0	9,999.0	50.08	13.34	11.10	25.9	D 19-42
40.0	1,099.6	465.7	633.9	9,999.0	51.13	12.87	10.78	25.1	D 19-42
45.0	1,157.5	523.6	633.9	9,999.0	51.34	12.24	10.49	24.1	D 19-42
50.3	1,227.0	593.2	633.9	9,999.0	51.19	9.86	10.25	22.8	D 19-42

FORWARD ABUTMENT

Driveability Analysis Summary
 Gain/Loss Factor at Shaft/Toe = 0.500/1.000

Depth ft	Rut kips	Rshaft kips	Rtoe kips	Blow Ct bl/ft	Mx C-Str ksi	Mx T-Str. ksi	Stroke ft	ENTHRU kip-ft	Hammer -
5.0	17.8	1.5	16.3	1.4	12.254	0.000	3.88	27.2	D 19-42
10.0	94.2	9.8	84.4	10.2	25.972	0.779	5.98	20.0	D 19-42
12.7	155.8	14.5	141.3	17.3	33.582	1.519	6.85	20.3	D 19-42
13.3	164.8	15.8	149.0	18.5	34.310	1.749	6.96	20.3	D 19-42
15.0	188.8	19.6	169.2	21.2	37.208	2.494	7.34	21.1	D 19-42
16.0	203.1	22.1	181.0	23.0	38.749	2.822	7.55	21.6	D 19-42
16.5	209.6	23.2	186.4	23.9	39.777	2.990	7.66	21.7	D 19-42
17.0	217.6	24.7	192.9	25.1	40.920	3.307	7.79	21.9	D 19-42
18.0	232.3	27.5	204.8	27.3	42.837	4.052	8.01	22.4	D 19-42
19.0	247.1	30.5	216.6	29.5	44.699	4.680	8.24	23.0	D 19-42
20.0	262.1	33.6	228.5	32.6	46.235	5.110	8.46	23.2	D 19-42
21.0	277.3	36.9	240.4	35.4	48.024	5.542	8.67	23.8	D 19-42
22.0	292.6	40.3	252.2	38.6	49.692	6.104	8.89	24.3	D 19-42
23.0	308.1	44.0	264.1	42.1	51.241	6.741	9.12	24.9	D 19-42
24.0	323.7	47.8	276.0	46.0	52.564	7.283	9.33	25.5	D 19-42
25.0	339.6	51.7	287.8	51.1	53.851	7.703	9.55	25.9	D 19-42
30.0	421.2	74.0	347.2	97.7	58.556	7.837	10.55	28.1	D 19-42
32.0	663.6	84.3	579.3	9999.0	66.142	9.378	11.67	30.4	D 19-42
33.4	671.4	92.1	579.3	9999.0	65.459	9.297	11.59	30.4	D 19-42
35.0	680.8	101.5	579.3	9999.0	65.235	9.099	11.92	30.7	D 19-42
40.0	713.5	134.1	579.3	9999.0	61.590	7.319	11.45	29.4	D 19-42
47.9	259.3	206.6	52.7	29.3	33.082	1.404	7.59	20.0	D 19-42

Refusal occurred; no driving time output possible.

0 ft @ Ele. 823.33 ft amsl (pile cap elevation)

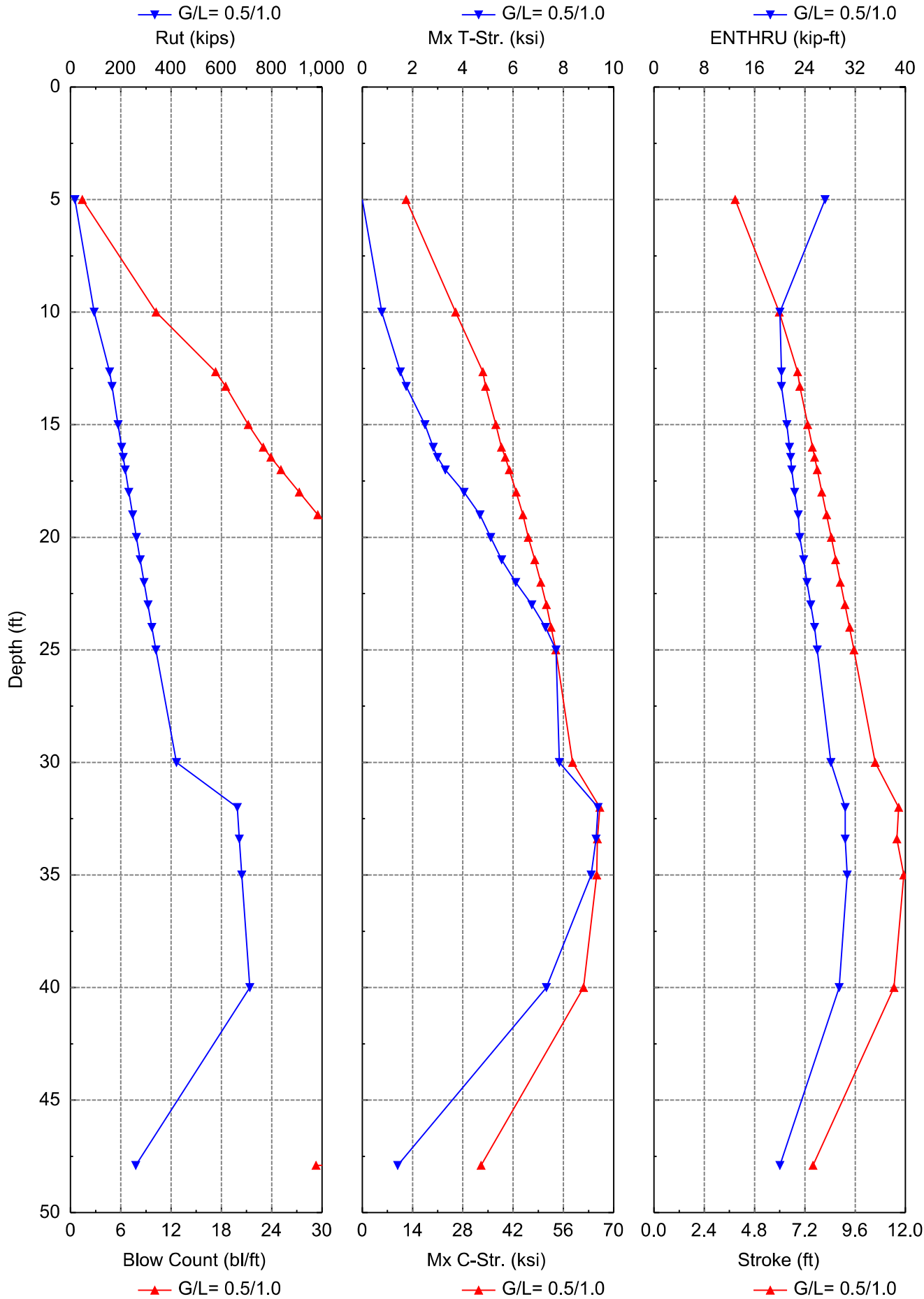

Driveability Analysis Summary
 Gain/Loss Factor at Shaft/Toe = 1.000/1.000

Depth ft	Rut kips	Rshaft kips	Rtoe kips	Blow Ct bl/ft	Mx C-Str ksi	Mx T-Str. ksi	Stroke ft	ENTHRU kip-ft	Hammer -
5.0	19.3	3.1	16.3	1.6	12.767	0.000	3.96	26.7	D 19-42
10.0	103.1	18.7	84.4	11.5	27.587	0.935	6.14	19.8	D 19-42
12.7	164.7	23.4	141.3	18.6	33.923	1.916	6.96	20.4	D 19-42
13.3	173.7	24.7	149.0	19.8	34.311	2.148	7.12	20.4	D 19-42
15.0	197.7	28.5	169.2	22.7	37.489	3.067	7.48	21.3	D 19-42
16.0	212.0	31.0	181.0	24.5	39.414	3.529	7.70	21.8	D 19-42
16.5	218.5	32.1	186.4	25.5	40.248	3.800	7.80	22.0	D 19-42
17.0	226.5	33.6	192.9	26.7	41.227	4.195	7.93	22.2	D 19-42
18.0	241.2	36.4	204.8	29.1	42.934	4.913	8.15	22.7	D 19-42
19.0	256.0	39.4	216.6	31.7	44.493	5.469	8.37	23.2	D 19-42
20.0	271.0	42.5	228.5	35.0	45.988	5.937	8.58	23.4	D 19-42
21.0	286.2	45.8	240.4	38.2	47.505	6.490	8.79	24.0	D 19-42
22.0	301.5	49.3	252.2	41.7	48.840	7.097	9.00	24.5	D 19-42
23.0	317.0	52.9	264.1	45.6	50.136	7.688	9.21	25.2	D 19-42
24.0	332.7	56.7	276.0	50.6	51.327	7.887	9.42	25.6	D 19-42
25.0	348.5	60.6	287.8	56.8	52.407	8.171	9.62	26.0	D 19-42
30.0	430.1	82.9	347.2	119.4	56.484	8.166	10.56	28.0	D 19-42
32.0	672.5	93.2	579.3	9999.0	63.538	9.867	11.81	30.5	D 19-42
33.4	680.3	101.0	579.3	9999.0	62.744	9.563	11.69	30.1	D 19-42
35.0	689.7	110.4	579.3	9999.0	61.598	8.910	11.52	29.7	D 19-42
40.0	722.4	143.1	579.3	9999.0	57.950	6.182	11.05	28.2	D 19-42
47.9	279.9	227.3	52.7	36.3	33.701	1.545	7.80	20.0	D 19-42

Refusal occurred; no driving time output possible.

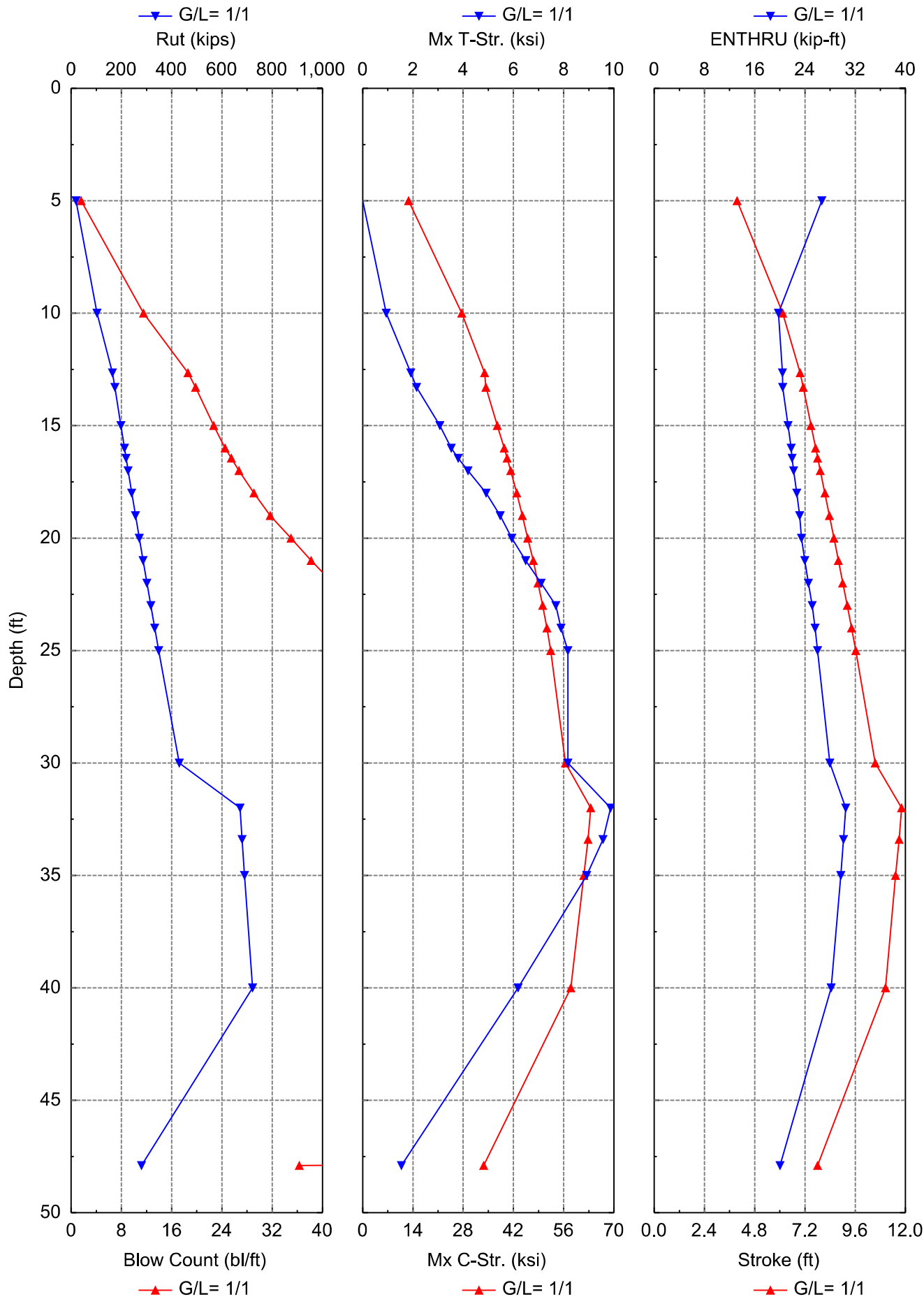

SOIL PROFILE

Depth ft	Soil Type -	Spec. Wt lb/ft ³	Su ksf	Phi °	Unit Rs ksf	Unit Rt ksf
0.0	Sand	122.0	0.0	0.0	0.00	0.00
4.0	Sand	122.0	0.0	0.0	0.00	0.47
4.0	Clay	122.0	2.3	0.0	1.05	20.70
9.4	Clay	122.0	2.3	0.0	1.05	20.70
9.4	Sand	130.0	0.0	41.0	0.46	100.45
12.4	Sand	130.0	0.0	41.0	0.62	135.27
12.4	Sand	130.0	0.0	42.0	0.62	176.12
31.4	Sand	130.0	0.0	42.0	1.63	463.20
31.4	Sand	140.0	0.0	47.0	1.69	737.59
46.4	Sand	140.0	0.0	47.0	2.64	737.59
46.4	Clay	140.0	7.4	42.0	7.45	67.05
47.9	Clay	140.0	7.4	42.0	7.45	67.05

0 ft @ Ele. 823.33 ft amsl (pile cap elevation)

GRLWEAP: Wave Equation Analysis of Pile Foundations

Proposed Pedestrian Bridge + Forward Abutment
NATIONAL ENGINEERING AND ARCHITECTURAL

1/31/2025
GRLWEAP 14.1.20.1

ABOUT THE WAVE EQUATION ANALYSIS RESULTS

The GRLWEAP program simulates the behavior of a preformed pile driven by either an impact hammer or a vibratory hammer. The program is based on mathematical models, which describe motion and forces of hammer, driving system, pile and soil under the hammer action. Under certain conditions, the models only crudely approximate, often complex, dynamic situations.

A wave equation analysis generally relies on input data, which represents normal situations. In particular, the hammer data file supplied with the program assumes that the hammer is in good working order. All of the input data selected by the user may be the best available information at the time when the analysis is performed. However, input data and therefore results may significantly differ from actual field conditions.

Therefore, the program authors recommend prudent use of the GRLWEAP results. Soil response and hammer performance should be verified by static and/or dynamic testing and measurements. Estimates of bending or other local stresses (e.g., helmet or clamp contact, uneven rock surfaces etc.), prestress effects and others must also be accounted for by the user.

The calculated capacity-blow count relationship, i.e. the bearing graph, should be used in conjunction with observed blow counts for the capacity assessment of a driven pile. Soil setup occurring after pile installation may produce bearing capacity values that differ substantially from those expected from a wave equation analysis due to soil setup or relaxation. This is particularly true for pile driven with vibratory hammers. The GRLWEAP user must estimate such effects and should also use proper care when applying blow counts from restrike because of the variability of hammer energy, soil resistance and blow count during early restriking.

Finally, the GRLWEAP capacities are ultimate values. They MUST be reduced by means of an appropriate factor of safety to yield a design or working load. The selection of a factor of safety should consider the quality of the construction control, the variability of the site conditions, uncertainties in the loads, the importance of structure and other factors.

HAMMER DATA

Hammer Model:	D 19-42	Made By:	DELMAG
Hammer ID:	41	Hammer Type:	OED
Hammer Database Type:	PDI		
Hammer Database Name:			PDIHammer.gwh

Hammer and Drive System Segment Data

Segment	Weight kips	Stiffness kips/in	COR -	C-Slack in	Damping kips/ft/s
1	0.800	140,084.4	1.000	0.000	
2	0.800	140,084.4	1.000	0.000	
3	0.800	140,084.4	1.000	0.000	
4	0.800	140,084.4	1.000	0.000	
5	0.800	70,754.7	0.900	0.120	
Imp Block	0.753	109,976.0	0.800	0.120	
Helmet	2.500				5.3

Ram Weight: (kips)	4.00	Ram Length: (ft)	10.76
Ram Area: (in ²)	124.69		
Maximum (Eq) Stroke: (ft)	10.81	Actual (Eq) Stroke: (ft)	10.81
Efficiency:	0.800	Rated Energy: (kip-ft)	43.24
Maximum Pressure: (psi)	1,600.00	Actual Pressure: (psi)	1,600.00
Combustion Delay: (ms)	2.00	Ignition Duration: (ms)	2.00
Expansion Exponent:	1.25		

Hammer Cushion

Pile Cushion

Cross Sect. Area: (in ²)	415.00	Cross Sect. Area: (in ²)	0.00
Elastic Modulus: (ksi)	530.0	Elastic Modulus: (ksi)	0.0
Thickness: (in)	2.00	Thickness: (in)	0.00
Coeff. of Restitution:	0.800	Coeff. of Restitution:	0.500
RoundOut: (in)	0.120	RoundOut: (in)	0.120
Stiffness: (kips/in)	109,976.0	Stiffness: (kips/in)	0.0
Helmet Weight: (kips)	2.500		

PILE INPUT

Uniform Pile		Pile Type:	Closed-End Pipe
Pile Length: (ft)	60.000	Pile Penetration: (ft)	47.900
Pile Size: (ft)	1.00	Toe Area: (in ²)	113.10

Table of Depths Analyzed with Driving System Modifiers

Depth ft	Temp Length ft	Wait Time Hr	Hammer -
5.00	55.0	0.0	DELMAG D 19-42
10.00	55.0	0.0	DELMAG D 19-42
12.65	55.0	0.0	DELMAG D 19-42
13.30	55.0	0.0	DELMAG D 19-42
15.00	55.0	0.0	DELMAG D 19-42
16.00	55.0	0.0	DELMAG D 19-42
16.45	55.0	0.0	DELMAG D 19-42
17.00	55.0	0.0	DELMAG D 19-42
18.00	55.0	0.0	DELMAG D 19-42
19.00	55.0	0.0	DELMAG D 19-42
20.00	55.0	0.0	DELMAG D 19-42
21.00	55.0	0.0	DELMAG D 19-42
22.00	55.0	0.0	DELMAG D 19-42
23.00	55.0	0.0	DELMAG D 19-42
24.00	55.0	0.0	DELMAG D 19-42
25.00	55.0	0.0	DELMAG D 19-42
30.00	55.0	0.0	DELMAG D 19-42
32.00	55.0	0.0	DELMAG D 19-42
33.40	55.0	0.0	DELMAG D 19-42
35.00	55.0	0.0	DELMAG D 19-42
40.00	55.0	0.0	DELMAG D 19-42
47.90	55.0	0.0	DELMAG D 19-42

Other Information for DELMAG D 19-42

Depth ft	Stroke ft	Diesel Pressure %	Efficiency -	P.C. Stiff. Fact. -	P.C. COR -
5.00	10.8	100.0	0.80	1.0	0.50
10.00	10.8	100.0	0.80	1.0	0.50
12.65	10.8	100.0	0.80	1.0	0.50
13.30	10.8	100.0	0.80	1.0	0.50
15.00	10.8	100.0	0.80	1.0	0.50
16.00	10.8	100.0	0.80	1.0	0.50
16.45	10.8	100.0	0.80	1.0	0.50
17.00	10.8	100.0	0.80	1.0	0.50
18.00	10.8	100.0	0.80	1.0	0.50
19.00	10.8	100.0	0.80	1.0	0.50
20.00	10.8	100.0	0.80	1.0	0.50
21.00	10.8	100.0	0.80	1.0	0.50
22.00	10.8	100.0	0.80	1.0	0.50

Proposed Pedestrian Bridge + Foundation Analysis NATIONAL ENGINEERING AND ARCHITECTURAL

23.00	10.8	100.0	0.80	1.0	0.50
24.00	10.8	100.0	0.80	1.0	0.50
25.00	10.8	100.0	0.80	1.0	0.50
30.00	10.8	100.0	0.80	1.0	0.50
32.00	10.8	100.0	0.80	1.0	0.50
33.40	10.8	100.0	0.80	1.0	0.50
35.00	10.8	100.0	0.80	1.0	0.50
40.00	10.8	100.0	0.80	1.0	0.50
47.90	10.8	100.0	0.80	1.0	0.50

PILE, SOIL, ANALYSIS OPTIONS

Analysis type:	Driveability Analysis	Soil Damping Option:	Smith
Max No Analysis Iterations:	0	Time Increment/Critical:	160
Residual Stress Analysis:	0	Analysis Time-Input(ms):	0
Output Level:	Normal	Gravitational Acceleration (ft/s ²):	32.169
Hammer Gravity (ft/s ²):	32.169	Pile Gravity (ft/s ²):	32.169

DRIVEABILITY ANALYSIS

Analysis Depth (ft)	47.90	Standard Soil Setup	
Hammer Name	DELMAG D 19-42	Hammer ID	41
Diesel Pressure: (psi)	230.40	Stroke (ft)	10.81
Efficiency	0.80		
Shaft Gain/Loss Factor	0.500	Toe Gain/Loss Factor	1.000
Shaft Gain/Loss Factor	1.000	Toe Gain/Loss Factor	1.000

SOIL RESISTANCE PARAMETERS

Depth ft	Unit Rs ksf	Unit Rt ksf	Qs in	Qt in	Js s/ft	Jt s/ft	Setup F. -	Limit D. ft	Setup TEB Hours	Area in ²
0.00	0.0	0.0	0.10	0.117	0.200	0.1	2.0	6.00	168.0	113.10
2.00	0.0	0.2	0.10	0.117	0.200	0.1	2.0	6.00	168.0	113.10
4.00	0.0	0.5	0.10	0.117	0.200	0.1	2.0	6.00	168.0	113.10
4.00	1.1	20.7	0.10	0.117	0.200	0.1	2.0	6.00	168.0	113.10
9.40	1.1	20.7	0.10	0.117	0.200	0.1	2.0	6.00	168.0	113.10
9.40	0.5	100.5	0.10	0.110	0.050	0.1	1.0	6.00	1.0	113.10
10.90	0.5	117.9	0.10	0.110	0.050	0.1	1.0	6.00	1.0	113.10
12.40	0.6	135.3	0.10	0.110	0.050	0.1	1.0	6.00	1.0	113.10
12.40	0.6	176.1	0.10	0.110	0.050	0.1	1.0	6.00	1.0	113.10
14.13	0.7	202.2	0.10	0.110	0.050	0.1	1.0	6.00	1.0	113.10
15.85	0.8	228.3	0.10	0.110	0.050	0.1	1.0	6.00	1.0	113.10
17.58	0.9	254.4	0.10	0.110	0.050	0.1	1.0	6.00	1.0	113.10
19.31	1.0	280.5	0.10	0.110	0.050	0.1	1.0	6.00	1.0	113.10
21.04	1.1	306.6	0.10	0.110	0.050	0.1	1.0	6.00	1.0	113.10
22.76	1.2	332.7	0.10	0.110	0.050	0.1	1.0	6.00	1.0	113.10
24.49	1.3	358.8	0.10	0.110	0.050	0.1	1.0	6.00	1.0	113.10
26.22	1.4	384.9	0.10	0.110	0.050	0.1	1.0	6.00	1.0	113.10
27.95	1.4	411.0	0.10	0.110	0.050	0.1	1.0	6.00	1.0	113.10
29.67	1.5	437.1	0.10	0.110	0.050	0.1	1.0	6.00	1.0	113.10
31.40	1.6	463.2	0.10	0.110	0.050	0.1	1.0	6.00	1.0	113.10
31.40	1.7	737.6	0.10	0.100	0.050	0.1	1.0	6.00	11.0	113.10
33.07	1.8	737.6	0.10	0.100	0.050	0.1	1.0	6.00	11.0	113.10
34.73	1.9	737.6	0.10	0.100	0.050	0.1	1.0	6.00	11.0	113.10
36.40	2.0	737.6	0.10	0.100	0.050	0.1	1.0	6.00	11.0	113.10
38.07	2.1	737.6	0.10	0.100	0.050	0.1	1.0	6.00	11.0	113.10
39.73	2.2	737.6	0.10	0.100	0.050	0.1	1.0	6.00	11.0	113.10
41.40	2.3	737.6	0.10	0.100	0.050	0.1	1.0	6.00	11.0	113.10
43.07	2.4	737.6	0.10	0.100	0.050	0.1	1.0	6.00	11.0	113.10
44.73	2.5	737.6	0.10	0.100	0.050	0.1	1.0	6.00	11.0	113.10
46.40	2.6	737.6	0.10	0.100	0.050	0.1	1.0	6.00	11.0	113.10
46.40	7.4	67.0	0.10	0.100	0.150	0.1	1.5	6.00	168.0	113.10

Proposed Pedestrian Bridge + Foundation
 NATIONAL ENGINEERING AND ARCHITECTURAL

47.90 7.4 67.0 0.10 0.100 0.150 0.1 1.5 6.00 168.0 113.10

PILE PROFILE

Lb Top ft	X-Area in ²	E-Mod ksi	Spec. Wt lb/ft ³	Perim. ft	C-Index -	Wave Sp ft/s	Impedance kips/ft/s
0.00	10.3	30,000	492.00	3.142	0	16,806.4	18.4
55.00	10.3	30,000	492.00	3.142	0	16,806.4	18.4

PILE AND SOIL MODEL Total Capacity Rut (kips): 259.305

Seg. -	Weight kips	Stiffn. kips/in	C-Slk in	T-Slk in	COR -	Ru kips	Js/Jt s/ft	Qs/Qt in	LbTop ft	Perim. ft	X-Area in ²
1	0.11	7,966	0.12	0.00	0.85	0.0	0.000	0.10	3.24	3.14	10.3
2	0.11	7,966	0.00	0.00	1.00	0.0	0.000	0.10	6.47	3.14	10.3
3	0.11	7,966	0.00	0.00	1.00	0.0	0.000	0.10	9.71	3.14	10.3
4	0.11	7,966	0.00	0.00	1.00	3.0	0.200	0.10	12.94	3.14	10.3
5	0.11	7,966	0.00	0.00	1.00	5.3	0.200	0.10	16.18	3.14	10.3
6	0.11	7,966	0.00	0.00	1.00	5.4	0.077	0.10	19.41	3.14	10.3
7	0.11	7,966	0.00	0.00	1.00	7.1	0.050	0.10	22.65	3.14	10.3
8	0.11	7,966	0.00	0.00	1.00	8.9	0.050	0.10	25.88	3.14	10.3
9	0.11	7,966	0.00	0.00	1.00	10.6	0.050	0.10	29.12	3.14	10.3
10	0.11	7,966	0.00	0.00	1.00	12.3	0.050	0.10	32.35	3.14	10.3
11	0.11	7,966	0.00	0.00	1.00	14.1	0.050	0.10	35.59	3.14	10.3
12	0.11	7,966	0.00	0.00	1.00	15.9	0.050	0.10	38.82	3.14	10.3
13	0.11	7,966	0.00	0.00	1.00	18.5	0.050	0.10	42.06	3.14	10.3
14	0.11	7,966	0.00	0.00	1.00	20.5	0.050	0.10	45.29	3.14	10.3
15	0.11	7,966	0.00	0.00	1.00	22.6	0.050	0.10	48.53	3.14	10.3
16	0.11	7,966	0.00	0.00	1.00	24.7	0.050	0.10	51.76	3.14	10.3
17	0.11	7,966	0.00	0.00	1.00	37.5	0.121	0.10	55.00	3.14	10.3
Toe						52.7	0.149	0.10	55.00		

1.937 kips total unreduced pile weight (g = 32.169 ft/s²)

1.937 kips total reduced pile weight (g = 32.169 ft/s²)

OTHER OPTIONS

Pile Damping (%):	1	Pile Damping Fact. (kips/ft/s):	0.368
-------------------	---	---------------------------------	-------

EXTREMA TABLE at 47.9 FT; HAMMER: D 19-42

Shaft/Toe Gain/Loss Factor = 0.500/1.000

Rut = 259.3 kips Rtoe = 52.7 kips Time Inc. = 0.076 ms

Hammer DELMAG D 19-42 Efficiency 0.800

Lb Top ft	Mx.T-For. kips	Mx.C-For kips	Mx.T-Str. ksi	Mx.C-Str. ksi	Mx Vel. ft/s	Mx Dis. in	ENTHRU kip-ft
3.2	0.0	326.9	0.00	31.71	14.89	0.915	20.04
6.5	5.3	327.9	0.51	31.81	14.67	0.881	19.69
9.7	10.0	332.4	0.97	32.24	14.30	0.849	19.34
12.9	14.5	333.7	1.40	32.37	13.86	0.815	18.73
16.2	14.2	336.4	1.38	32.63	13.54	0.783	17.70
19.4	9.9	340.6	0.96	33.04	13.22	0.751	16.70
22.6	6.7	341.1	0.65	33.08	12.89	0.721	15.89
25.9	1.7	327.5	0.17	31.77	12.50	0.692	15.02
29.1	0.0	320.4	0.00	31.08	12.05	0.664	14.08
32.4	0.0	308.4	0.00	29.92	11.55	0.637	13.09
35.6	0.0	302.5	0.00	29.34	10.97	0.612	12.06
38.8	0.0	285.3	0.00	27.68	10.33	0.589	11.00
42.1	0.0	264.1	0.00	25.62	9.69	0.568	9.89
45.3	0.0	243.7	0.00	23.64	9.56	0.549	8.73
48.5	0.0	219.7	0.00	21.31	9.54	0.533	7.54
51.8	0.0	198.4	0.00	19.24	9.59	0.520	6.31
55.0	0.0	178.1	0.00	17.27	8.82	0.509	5.68

Converged Stroke (ft) 7.59 Fixed Combustion Pressure (psi) 1,600.0
 (Eq) Strokes Analyzed and Last Return (ft)
 10.81 7.31 7.62 7.59

Shaft/Toe Gain/Loss Factor = 1.000/1.000

Rut = 279.9 kips Rtoe = 52.7 kips Time Inc. = 0.076 ms

Hammer DELMAG D 19-42 Efficiency 0.800

Lb Top ft	Mx.T-For. kips	Mx.C-For kips	Mx.T-Str. ksi	Mx.C-Str. ksi	Mx Vel. ft/s	Mx Dis. in	ENTHRU kip-ft
3.2	0.0	346.0	0.00	33.56	15.22	0.874	20.04
6.5	6.5	346.2	0.63	33.58	14.91	0.837	19.60
9.7	11.7	347.2	1.14	33.68	14.26	0.800	19.17
12.9	15.9	347.4	1.54	33.70	13.55	0.764	18.27
16.2	11.7	347.0	1.13	33.65	13.20	0.729	16.58
19.4	3.7	343.7	0.36	33.34	12.89	0.695	15.16
22.6	0.4	344.4	0.04	33.41	12.54	0.663	14.31
25.9	0.0	331.4	0.00	32.14	12.13	0.631	13.46
29.1	0.0	323.2	0.00	31.35	11.67	0.601	12.55

Proposed Pedestrian Bridge + Foundation **NATIONAL ENGINEERING AND ARCHITECTURAL**

32.4	0.0	311.0	0.00	30.17	11.15	0.572	11.60
35.6	0.0	310.5	0.00	30.11	10.57	0.545	10.63
38.8	0.0	295.0	0.00	28.61	9.92	0.520	9.65
42.1	0.0	273.0	0.00	26.48	9.36	0.497	8.65
45.3	0.0	252.8	0.00	24.52	9.12	0.477	7.63
48.5	0.0	228.4	0.00	22.16	9.08	0.458	6.60
51.8	0.0	201.9	0.00	19.58	9.21	0.443	5.56
55.0	0.0	183.6	0.00	17.81	8.37	0.431	5.02

Converged Stroke (ft) 7.80 Fixed Combustion Pressure (psi) 1,600.0
 (Eq) Strokes Analyzed and Last Return (ft)
 10.81 7.60 7.85 7.80

SUMMARY TABLE at 47.9 FT; HAMMER: D 19-42

Rut kips	BI Ct b/ft	Stk Dn ft	Stk Up ft	Mx T-Str ksi	LTop ft	Mx C-Str ksi	LTop ft	ENTHRU kip-ft	BI Rt b/min	ActRes kips
259.3	29.3	7.59	0.00	1.40	12.9	33.08	22.6	20.0	42.7	259.3
279.9	36.3	7.80	0.00	1.54	12.9	33.70	12.9	20.0	42.2	279.9

SUMMARY OVER DEPTHS

G/L at Shaft and Toe: 0.500/1.000

Depth ft	Rut kips	Rshaft kips	Rtoe kips	BI Ct b/ft	Mx C-Str ksi	Mx T-Str ksi	Stroke ft	ENTHRU kip-ft	Hammer -
5.0	17.8	1.5	16.3	1.4	12.25	0.00	3.88	27.2	D 19-42
10.0	94.2	9.8	84.4	10.2	25.97	0.78	5.98	20.0	D 19-42
12.7	155.8	14.5	141.3	17.3	33.58	1.52	6.85	20.3	D 19-42
13.3	164.8	15.8	149.0	18.5	34.31	1.75	6.96	20.3	D 19-42
15.0	188.8	19.6	169.2	21.2	37.21	2.49	7.34	21.1	D 19-42
16.0	203.1	22.1	181.0	23.0	38.75	2.82	7.55	21.6	D 19-42
16.5	209.6	23.2	186.4	23.9	39.78	2.99	7.66	21.7	D 19-42
17.0	217.6	24.7	192.9	25.1	40.92	3.31	7.79	21.9	D 19-42
18.0	232.3	27.5	204.8	27.3	42.84	4.05	8.01	22.4	D 19-42
19.0	247.1	30.5	216.6	29.5	44.70	4.68	8.24	23.0	D 19-42
20.0	262.1	33.6	228.5	32.6	46.23	5.11	8.46	23.2	D 19-42
21.0	277.3	36.9	240.4	35.4	48.02	5.54	8.67	23.8	D 19-42
22.0	292.6	40.3	252.2	38.6	49.69	6.10	8.89	24.3	D 19-42
23.0	308.1	44.0	264.1	42.1	51.24	6.74	9.12	24.9	D 19-42
24.0	323.7	47.8	276.0	46.0	52.56	7.28	9.33	25.5	D 19-42
25.0	339.6	51.7	287.8	51.1	53.85	7.70	9.55	25.9	D 19-42
30.0	421.2	74.0	347.2	97.7	58.56	7.84	10.55	28.1	D 19-42
32.0	663.6	84.3	579.3	9,999.0	66.14	9.38	11.67	30.4	D 19-42
33.4	671.4	92.1	579.3	9,999.0	65.46	9.30	11.59	30.4	D 19-42
35.0	680.8	101.5	579.3	9,999.0	65.24	9.10	11.92	30.7	D 19-42
40.0	713.5	134.1	579.3	9,999.0	61.59	7.32	11.45	29.4	D 19-42
47.9	259.3	206.6	52.7	29.3	33.08	1.40	7.59	20.0	D 19-42

G/L at Shaft and Toe: 1.000/1.000

Depth ft	Rut kips	Rshaft kips	Rtoe kips	BI Ct b/ft	Mx C-Str ksi	Mx T-Str ksi	Stroke ft	ENTHRU kip-ft	Hammer -
5.0	19.3	3.1	16.3	1.6	12.77	0.00	3.96	26.7	D 19-42
10.0	103.1	18.7	84.4	11.5	27.59	0.93	6.14	19.8	D 19-42
12.7	164.7	23.4	141.3	18.6	33.92	1.92	6.96	20.4	D 19-42
13.3	173.7	24.7	149.0	19.8	34.31	2.15	7.12	20.4	D 19-42
15.0	197.7	28.5	169.2	22.7	37.49	3.07	7.48	21.3	D 19-42
16.0	212.0	31.0	181.0	24.5	39.41	3.53	7.70	21.8	D 19-42
16.5	218.5	32.1	186.4	25.5	40.25	3.80	7.80	22.0	D 19-42
17.0	226.5	33.6	192.9	26.7	41.23	4.19	7.93	22.2	D 19-42
18.0	241.2	36.4	204.8	29.1	42.93	4.91	8.15	22.7	D 19-42
19.0	256.0	39.4	216.6	31.7	44.49	5.47	8.37	23.2	D 19-42
20.0	271.0	42.5	228.5	35.0	45.99	5.94	8.58	23.4	D 19-42
21.0	286.2	45.8	240.4	38.2	47.51	6.49	8.79	24.0	D 19-42

Proposed Pedestrian Bridge + Foundation Alternatives NATIONAL ENGINEERING AND ARCHITECTURAL

22.0	301.5	49.3	252.2	41.7	48.84	7.10	9.00	24.5	D 19-42
23.0	317.0	52.9	264.1	45.6	50.14	7.69	9.21	25.2	D 19-42
24.0	332.7	56.7	276.0	50.6	51.33	7.89	9.42	25.6	D 19-42
25.0	348.5	60.6	287.8	56.8	52.41	8.17	9.62	26.0	D 19-42
30.0	430.1	82.9	347.2	119.4	56.48	8.17	10.56	28.0	D 19-42
32.0	672.5	93.2	579.3	9,999.0	63.54	9.87	11.81	30.5	D 19-42
33.4	680.3	101.0	579.3	9,999.0	62.74	9.56	11.69	30.1	D 19-42
35.0	689.7	110.4	579.3	9,999.0	61.60	8.91	11.52	29.7	D 19-42
40.0	722.4	143.1	579.3	9,999.0	57.95	6.18	11.05	28.2	D 19-42
47.9	279.9	227.3	52.7	36.3	33.70	1.54	7.80	20.0	D 19-42

SECTION 3
RETAINING WALLS

SECTION 3: RETAINING WALLS

TABLE OF CONTENTS

3.1. INTRODUCTION.....	2
3.1.1. PROPOSED CONSTRUCTION	2
3.2. GEOTECHNICAL FINDINGS.....	2
3.2.1. SUBSURFACE CONDITIONS	2
3.2.1.1. <i>Overburden Soil</i>	2
3.2.1.2. <i>Groundwater</i>	3
3.2.1.3. <i>Bedrock</i>	3
3.3. ANALYSIS AND RECOMMENDATIONS.....	4
3.3.1. RETAINING WALL DESIGN ASSUMPTIONS	4
3.3.2. GENERALIZED SOIL PROFILE FOR ANALYSIS	5
3.3.3. EXTERNAL STABILITY	6
3.3.4. GLOBAL STABILITY.....	7
3.3.5. SETTLEMENT.....	8
3.3.6. TEMPORARY EXCAVATIONS.....	8
3.3.7. DRAINAGE CONSIDERATIONS	9

LIST OF TABLES

TABLE 1:	DESIGN SOIL PARAMETERS FOR FILL MATERIALS.....	4
TABLE 2:	SOIL PROFILE AND ESTIMATED ENGINEERING PROPERTIES - AT BORING B-001-0-23	5
TABLE 3:	SOIL PROFILE AND ESTIMATED ENGINEERING PROPERTIES - AT BORING B-001-1-24	5
TABLE 4:	SOIL PROFILE AND ESTIMATED ENGINEERING PROPERTIES - AT BORING B-001-2-24	5
TABLE 5:	SOIL PROFILE AND ESTIMATED ENGINEERING PROPERTIES - AT BORING B-001-3-24	6
TABLE 6:	SETTLEMENT PARAMETERS FOR ANALYSIS	6
TABLE 7:	EXTERNAL STABILITY ANALYSIS SUMMARY.....	7
TABLE 8:	SETTLEMENT ANALYSIS SUMMARY.....	8

LIST OF APPENDICES

- APPENDIX 3A: GENERALIZED SUBSURFACE PROFILE
- APPENDIX 3B: EXTERNAL STABILITY ANALYSIS
- APPENDIX 3C: GLOBAL STABILITY ANALYSIS
- APPENDIX 3D: SETTLEMENT ANALYSIS

3.1. INTRODUCTION

3.1.1. Proposed Construction

It is our understanding that ODOT is planning the addition of a safe access path from the Little Miami Scenic Trail (LMST) to the newly constructed facilities at the Great Council State Park and Shawnee Interpretive Center, located within Oldtown, Ohio. The proposed project will include the construction of a new pedestrian bridge structure to direct pedestrian and bike traffic from the LMST, west over Oldtown Creek and US-68, to the existing sidewalk located on the west side of US-68. As part of the referenced project, six (6) new retaining walls are planned on the west side of US-68, in the vicinity of the rear abutment of the proposed bridge. The referenced walls, designated as Retaining Walls 1 through 6 (RW-1 through RW-6), are proposed to provide grade separation between the proposed pedestrian path and the surrounding area as it descends from the bridge to the existing sidewalk grade.

Based on design information for each of the proposed retaining walls provided by Carpenter Marty Transportation (Carpenter Marty) via email on January 23, 2025, it is our understanding that the proposed walls will vary in length between approximately 36 ft and 110 ft and with a maximum height of approximately 21.3 ft. The proposed walls will be located along various portions of the proposed path alignment from about 120 ft west of US-68 (approximate STA. 1+81.6 of path alignment) to the rear abutment of the proposed pedestrian bridge (approximate STA. 4+92.2 of path alignment). For analysis purposes, the proposed walls are anticipated to bear at an elevation of about 833.7 ft above mean sea level (amsl), with the exception of RW-6 which is anticipated to bear at an elevation of about 842.9 ft amsl. The proposed retaining wall will be constructed following a bottom-up construction sequence, and the likely wall type will be a semi-gravity cantilever, cast-in-place (CIP) retaining wall, bearing on either the existing soils encountered at the site or the proposed embankment fill soils (RW-6).

3.2. GEOTECHNICAL FINDINGS

The subsurface conditions encountered during NEAS's explorations for the proposed retaining wall site are described in the following subsections and on each boring log presented in Appendix 1B. The boring logs represent NEAS's interpretation of the subsurface conditions encountered at each boring location based on our site observations, field logs, visual review of the soil samples by NEAS's geologist, and laboratory test results. The lines designating the interfaces between various soil strata on the boring logs represent the approximate interface location; the actual transition between strata may be gradual and indistinct. The subsurface soil and groundwater characterizations included herein, including summary test data, are based on the subsurface findings from the geotechnical explorations performed by Stantec as part of the initial phases of the referenced project, the supplementary exploration performed by NEAS, and consideration of the geological history of the site.

3.2.1. Subsurface Conditions

3.2.1.1. Overburden Soil

At the proposed site of the retaining walls, two different materials were generally encountered below the existing topsoil or ground surface. In general, the two different overburden materials consisted of either "man-made" fill / potential fill soils or natural glacial till soils. These materials and the general profile are further described below.

Structure Foundation Exploration Report
Proposed Retaining Walls
GRE-68-12.65
Greene County, Ohio
PID: 115388

Fill / potential fill soils were encountered in each of the borings performed at the site of the proposed retaining walls extending to depths ranging from 2.8 ft to 9.5 ft bgs (elevations 826.9 to 838.0 ft amsl). Based on laboratory testing results and a visual review of the samples obtained, the fill at the site is generally comprised of cohesive, fine-grained materials that are classified on the boring logs as either cohesive Sandy Silt (A-4a), Silt and Clay (A-6a), Silty Clay (A-6b), and Clay (A-7-6). The exception being relatively thin layers (2.5-ft thick) of granular material being encountered within the fill soils in boring B-001-1-24. With respect to the soil strength of the fill soils encountered, these soils can be described as having a consistency of medium stiff to hard correlating to converted SPT-N (N_{60}) values between 6 and 19 blows per foot (bpf) and unconfined compressive strengths (estimated by means of hand penetrometer) between 1.25 and 4.5 tons per square foot (tsf). The natural moisture content of these soils ranged from 15 to 22 percent. Based on Atterberg Limits tests performed on representative samples of the natural cohesive material, the liquid and plastic limits ranged from 25 to 60 percent and from 16 to 24 percent, respectively. The granular fill encountered at the site is classified on the boring logs as Gravel with Sand and Silt (A-2-4) and Coarse and Fine Sand (A-3a) with a relative compactness of loose to medium dense correlating to N_{60} values between 7 and 22 bpf. Natural moisture contents of the non-cohesive fill soils ranged from 11 to 15 percent.

Naturally deposited glacial till soils were encountered underlying the fill/potential fill soils in each of the borings performed at the site of the retaining walls. In general, the till consisted of coarse-grained, non-cohesive soils, though relatively thin layers (1.5-ft to 2.5-ft thick) of material visually classified as fine-grained, cohesive soil were encountered in this stratum in borings B-001-0-23 and B-001-1-24. The natural till material extended to borehole termination depth in each boring with termination depths ranging from 36.5 to 51.5 ft bgs (elevations 804.3 to 786.5 ft amsl). The non-cohesive till encountered at the site classified on the boring logs as Gravel and/or Stone Fragments (A-1-a), Gravel and/or Stone Fragments with Sand (A-1-b), Gravel with Sand and Silt (A-2-4), and Coarse and Fine Sand (A-3a). The granular till soils can be described as having a relative compactness of loose to very dense correlating to N_{60} values between 10 bpf and SPT-N refusal (i.e., less than 6 inches of penetration over 50 blows). Natural moisture contents of the non-cohesive till ranged from 2 to 25 percent. The cohesive till encountered at the site was visually identified and classified on the boring logs as cohesive Sandy Silt (A-4a) and can be described as having a consistency of stiff to hard correlating to N_{60} values between 58 and 76 bpf and unconfined compressive strengths (estimated by means of hand penetrometer) between 1.5 and 4.5 tsf. Natural moisture contents of the cohesive till ranged from 11 to 17 percent.

3.2.1.2. Groundwater

Groundwater measurements were taken during the boring drilling procedures and immediately following the completion of each borehole. Groundwater was observed during and/or upon completion of drilling in each of the borings performed as part of the referenced retaining wall structure foundation exploration. Based on measurements at boring location, groundwater was encountered at depths ranging from 21.0 to 25.0 ft bgs (elevations 814.4 to 817.0 ft amsl).

It should be noted that groundwater is affected by many hydrologic characteristics in the area and may vary from those measured at the time of the exploration. The specific groundwater readings are included on the boring logs located within Appendix 1B.

3.2.1.3. Bedrock

Bedrock was not encountered within the borings performed at the site.

Structure Foundation Exploration Report
Proposed Retaining Walls
GRE-68-12.65
Greene County, Ohio
PID: 115388

3.3. ANALYSIS AND RECOMMENDATIONS

We understand that the construction of six (6) retaining walls on the west side of US-68 are required to facilitate the construction of a new segment of pedestrian and bike trail as part of the GRE-68-12.65 (PID 115388) project in Oldtown, Greene County, Ohio. The newly proposed retaining walls will support the new trail segment’s embankment soils while providing grade separation between the proposed path and the surrounding area as it descends from the bridge to the existing sidewalk grade. Based on design information for each of the proposed retaining walls provided by Carpenter Marty via email on January 23, 2025, it is our understanding that the walls will consist of typical CIP walls bearing on either the existing fill/potential fill soils encountered at the site or on the newly placed embankment fill soils proposed as part of the new path construction.

Geotechnical analyses consisting of external stability (i.e., bearing resistance, eccentricity, and sliding resistance), global stability, and settlement were performed for each of the proposed retaining walls. The analyses performed are based on the information presented in Sections 3.3.1. and 3.3.2. of this report in addition to: 1) the soil characteristics gathered during the subsurface exploration (i.e., SPT results, laboratory test results, etc.); 2) the above indicated proposed design information for the referenced retaining walls provided by Carpenter Marty; and, 3) other design assumptions presented in subsequent sections of this report.

The geotechnical engineering analyses were performed in accordance with AASHTO's Publication LRFD BDS (AASHTO, 2020) and ODOT’s January 2024 revision of the 2020 BDM (ODOT, 2024). Based on the results of the analysis, it is our opinion that the subsurface conditions encountered are generally satisfactory and will provide adequate resistance to bearing, sliding and overturning assuming the proposed retaining walls are constructed in accordance with the recommendations provided within this report as well as all applicable standards and specifications.

3.3.1. Retaining Wall Design Assumptions

As the proposed retaining wall is planned as a CIP type wall founded on the existing soil at the site, ODOT's BDM, AASHTO's LRFD BDS, and the project conditions dictate analysis parameters and design minimums/constraints to be used in the analysis and design process. The referenced parameters and design minimums/constraints that were significant to our analyses consist of the following:

- Porous backfill is to be placed from back of the wall extending from top of footing elevation to top of earth backfill with a width not less than 2 feet.
- Retained soils behind the porous backfill are to consist of material placed and compacted in accordance with Item 203, Roadway Excavation and Embankment, of the ODOT Construction and Material Specifications (CMS);
- Retained fill soils will meet the minimum design soil parameters per Table 307-1 of ODOT's BDM as shown in Table 1 below;

Table 1: Design Soil Parameters for Fill Materials

Fill Zone	Type of Soil	Soil Unit Weight (pcf)	Friction Angle (°)	Cohesion (psf)
Retained Soil (Soil behind the wall heel)	On-site soil varying from sandy lean clay to silty sand, per 703.16.A	120	30	0
CIP Wall Infill	Granular Embankment, per 703.16.B	120	32	0
<i>Notes:</i>				
1. From Table 307-1 of ODOT's BDM.				

Structure Foundation Exploration Report
Proposed Retaining Walls
GRE-68-12.65
Greene County, Ohio
PID: 115388

With respect to retaining wall specific design constraints and assumptions, the geometry of the proposed wall (i.e., exposed wall heights, existing ground elevations, proposed final grade behind/at the toe of the wall, etc.) are based on the proposed retaining wall design information provided by Carpenter Marty via email on January 23, 2025.

3.3.2. Generalized Soil Profile for Analysis

For analysis purposes, each boring log was reviewed, and a generalized material profile was developed for analysis. Utilizing the generalized soil profile, engineering properties for each soil strata was estimated based on their field (i.e., SPT N_{60} Values, hand penetrometer values, etc.) and laboratory (i.e., Atterberg Limits, grain size, etc.) test results using correlations provided in published engineering manuals, research reports and guidance documents. Engineering soil properties were estimated for each individual classified layer per boring location. Soil layers from each boring with similar behavior (i.e., cohesive or non-cohesive/granular) and characteristics (i.e., relative compactness/consistency, moisture content, etc.) were grouped into generalized soil units (i.e., Soil Types) and weighted average values of the estimated engineering soil properties were assigned to each Soil Type to develop a generalized soil profile for analysis. The summary of the generalized soil profile including designated Soil Types, elevations, average engineering soil properties per boring location are presented in Tables 2 through 5 below. Settlement parameters (with sited correlation/reference material) developed for the proposed retaining walls estimated for each of the referenced Soil Types are presented within Table 6 below.

Table 2: Soil Profile and Estimated Engineering Properties - At Boring B-001-0-23

Retaining Walls: Profile for Analysis, B-001-0-23				
Soil Description	Unit Weight (pcf)	Undrained Shear Strength (psf)	Effective Cohesion (psf)	Effective Friction Angle (degrees)
Soil Type 1 ⁽²⁾ Depth (838 ft - 831.5 ft)	125	2100	205	22
Soil Type 2 Depth (831.5 ft - 786.5 ft)	130	-	-	39
<i>Notes:</i>				
1. Values calculated per Ohio Department of Transportation (ODOT) GDM Section 404/1304 and/or ODOT BDM Table 305-2.				
2. Undrained shear strength and unit weight based on laboratory test results from B-001-0-23 - ST-2. Testing report provided within appendices.				

Table 3: Soil Profile and Estimated Engineering Properties - At Boring B-001-1-24

Retaining Walls: Profile for Analysis, B-001-1-24				
Soil Description	Unit Weight (pcf)	Undrained Shear Strength (psf)	Effective Cohesion (psf)	Effective Friction Angle (degrees)
Soil Type 1 ⁽²⁾ Depth (836.4 ft - 826.9 ft)	125	2100	205	22
Soil Type 2 Depth (826.9 ft - 799.9 ft)	130	-	-	39
<i>Notes:</i>				
1. Values calculated per Ohio Department of Transportation (ODOT) GDM Section 404/1304 and/or ODOT BDM Table 305-2.				
2. Undrained shear strength and unit weight based on laboratory test results from B-001-0-23 - ST-2. Testing report provided within appendices.				

Table 4: Soil Profile and Estimated Engineering Properties - At Boring B-001-2-24

Retaining Walls: Profile for Analysis, B-001-2-24				
Soil Description	Unit Weight (pcf)	Undrained Shear Strength (psf)	Effective Cohesion (psf)	Effective Friction Angle (degrees)
Soil Type 1 ⁽²⁾ Depth (840.7 ft - 836.2 ft)	125	2100	205	22
Soil Type 2 Depth (836.2 ft - 804.2 ft)	130	-	-	39
<i>Notes:</i>				
1. Values calculated per Ohio Department of Transportation (ODOT) GDM Section 404/1304 and/or ODOT BDM Table 305-2.				
2. Undrained shear strength and unit weight based on laboratory test results from B-001-0-23 - ST-2. Testing report provided within appendices.				

Structure Foundation Exploration Report
Proposed Retaining Walls
GRE-68-12.65
Greene County, Ohio
PID: 115388

Table 5: Soil Profile and Estimated Engineering Properties - At Boring B-001-3-24

Retaining Walls: Profile for Analysis, B-001-3-24				
Soil Description	Unit Weight (pcf)	Undrained Shear Strength (psf)	Effective Cohesion (psf)	Effective Friction Angle (degrees)
Soil Type 1 ⁽²⁾ Depth (840.7 ft - 838 ft)	125	2100	205	22
Soil Type 2 Depth (838 ft - 804.3 ft)	130	-	-	39
Notes: 1. Values calculated per Ohio Department of Transportation (ODOT) GDM Section 404/1304 and/or ODOT BDM Table 305-2. 2. Undrained shear strength and unit weight based on laboratory test results from B-001-0-23 - ST-2. Testing report provided within appendices.				

Table 6: Settlement Parameters for Analysis

Retaining Walls: Parameters for Settlement Analysis								
Soil Description	Unit Weight (pcf)	Elastic Modulus ⁽¹⁾ (psf)	Poissons Ratio ⁽¹⁾ , ν	Void Ratio e_o	Compression Index ⁽²⁾ , C_c	Recompression Index ⁽³⁾ , C_r	OCR ⁽⁴⁾	Coeff. of Consol. ⁽⁵⁾ , C_v (ft ² /day)
Soil Type 1 - Cohesive ⁽⁶⁾	125	789000	0.40	0.707	0.166	0.013	6.0	0.04
Soil Type 2 - Granular	130	726000	0.30	-	-	-	-	-
Notes: 1. Values interpreted from 2017 AASHTO LRFD BDS Table C10.4.6.3-1 2. Values calculated from Kulhawy and Mayne, 1990, Equation 6-6. 3. Values calculated from Kulhawy and Mayne, 1990, Equation 6-9. 4. Values interpreted from Mayne and Kemper, 1988, Figure 7. 5. Values interpreted from FHWA GEC No. 5, Boeckmann, et al., 2016, Figure 6-37. 6. Based on laboratory consolidation testing of undisturbed sample ST-2 from boring B-001-3-24.								

In addition to the Soil Type parameters presented above, a graphical depiction of the generalized subsurface profile is located within Appendix 3A. The generalized subsurface profile includes: a color-coded general interpretation of the Soil Types between borings, a graphical interpretation of the soil strata identified by the project soil borings across the site of the proposed retaining walls, representative boring data (N_{60} -values, moisture contents, and groundwater levels) and current ground surface elevation.

3.3.3. External Stability

Based on our estimated engineering soil properties, the developed generalized profile and the retaining wall design assumptions provided in the above sections, external stability analyses of the proposed walls were performed. External stability was evaluated at one (1) cross-section along the length of each of the proposed walls with the sections evaluated consisting of the maximum total wall height section of each wall. Each of the referenced wall cross-sections were assumed to bear on Soil Type 1 (as characterized in Section 3.3.2. of this report) with the exception of the maximum wall height section for RW-6 which was assumed to bear within the proposed embankment soils. The soil properties of the proposed embankment soils assumed for our external stability analysis are based on values provided in Table 500-2 of ODOT's GDM. The referenced cross-sections were evaluated for resistance to bearing, sliding, and overturning at the Strength Limit State in accordance with Section 11.10.5 of AASHTO's LRFD BDS. The capacity to demand ratios (CDRs) calculated for the referenced cross-sections with respect to bearing, sliding and overturning, as well as the calculated factored bearing resistance, nominal bearing stress and factored bearing stress are presented in Table 7 below. External Stability calculation results are included within Appendix 3B.

Structure Foundation Exploration Report
Proposed Retaining Walls
GRE-68-12.65
Greene County, Ohio
PID: 115388

Table 7: External Stability Analysis Summary

External Stability Analysis Summary						
Dimensions						
Retaining Wall	RW-1	RW-2	RW-3	RW-4	RW-5	RW-6
Design Wall Height (feet)	21.3	17.8	17.8	12.7	12.7	12.2
Exposed Wall Height (feet)	17.8	14.3	14.3	9.2	9.2	8.7
Bearing Width (feet)	17.0	15.0	13.0	11.0	9.0	10.0
Capacity Demand Ratio (CDR)						
Sliding	1.4	1.5	1.3	1.4	1.2	1.6
Overturning / Eccentricity	>10.0	>10.0	6.6	>10.0	9.4	>10.0
Bearing Capacity	1.4	1.6	1.4	2.0	2.0	2.8
Factored Bearing Resistance (ksf) ⁽¹⁾	5.0	4.9	4.5	4.4	4.1	5.9
Nominal Bearing Stress (ksf) ⁽¹⁾	2.6	2.2	2.4	1.6	1.5	1.6
Factored Bearing Stress (ksf) ⁽¹⁾	3.5	3.0	3.2	2.2	2.0	2.1
Notes:						
1. Calculated in accordance to Section 11.10.5.4 of 2014 LRFD BDS and factored using Resistance Factor provided in Table 11.5.7-1 of 2014 LRFD BDS.						

3.3.4. Global Stability

For purposes of evaluating the stability of the proposed retaining wall site, NEAS reviewed the available cross-sections that were interpreted to represent conditions that posed the greatest potential for slope instability. In general, cross-sections along the proposed wall alignment were reviewed to determine if the section would represent a combination of existing subsurface conditions and planned site grading that would be most critical to slope stability (i.e., maximum total wall height, maximum embankment height measured from toe of slope to top of wall, proposed cut into existing embankment slopes, weak or thick soil layer, etc.). Based on our review of the available information at the referenced locations and the associated soil properties, two (2) cross-sections were estimated to be most "critical" and were analyzed for global stability. The cross-sections analyzed for global stability were the maximum total wall-height section of proposed RW-1 near approximate STA. 4+92.2 (proposed path alignment) and RW-3 near STA. 2+82.5 (proposed path alignment).

For the referenced cross-sections, NEAS developed a representative cross-sectional model to use as the basis for global stability analyses. The model was developed from NEAS's interpretation of the available information which included: 1) cross-sections and design information provided by Carpenter Marty via email on January 23, 2025; 2) a live load surcharge of 100 pounds per square foot (psf), accounting for potential heavy equipment induced loading during construction; and, 3) test borings and laboratory data developed as part of this report. With respect to the soil's engineering properties, the provided Soil Profile and Estimated Engineering Properties presented in Sections 3.3.1. and 3.3.2. of this report were used in our analyses.

The above referenced slope stability models were analyzed for long-term (Effective Stress) and short-term (Total Stress) slope stability utilizing the software entitled Slide2 by Rocscience, Inc. Specifically, the Spencer analysis methods were used to calculate a factor of safety (FOS) for circular and translational type slope failures. The FOS is the ratio of the resisting forces and the driving forces, with the desired safety factor being more than about 1.54 for RW-1 and 1.33 for RW-3 which equates to an AASHTO resistance factor less than 0.65 for RW-1 and 0.75 for RW-3 (per AASHTO's LRFD BDS the specified resistance factors are essentially the inverse of the FOS that should be targeted in slope stability programs). For the RW-1 analysis, a resistance factor of 0.65 or lower is targeted as RW-1 contains or supports a structural element (RW-6) while a resistance factor of 0.75 or lower is targeted for the RW-3 analysis as the wall does not support or contain a structural element.

Structure Foundation Exploration Report
Proposed Retaining Walls
GRE-68-12.65
Greene County, Ohio
PID: 115388

Based on our slope stability analysis for the referenced retaining wall sections, the minimum slope stability safety factor is about 1.77 (0.56 resistance factor). The graphical output of the slope stability program (cross-sectional model, calculated safety factor, and critical failure plane) is included within Appendix 3C.

3.3.5. Settlement

In order to estimate the maximum total and differential settlement that could result within the subsurface soils supporting the proposed retaining walls, NEAS reviewed: 1) the proposed retaining wall plans provided by Carpenter Marty via email on January 23, 2025; 2) Service Limit State loading conditions; and, 3) the generalized subsurface profile and Settlement Parameters for Analysis provided in Section 3.3.2. of this report. Utilizing this information and the software entitled *Settle3* by Rocscience Inc., a settlement model was developed and analyzed to for both elastic (immediate) and consolidation (long term) settlement.

Based on our analyses, the estimated maximum total settlement that could occur along the length of proposed retaining walls as a result of the induced wall and embankment loads is estimated to range from about 0.7 to 2.3 inches with about 0.2 to 1.5 inches of the total settlement estimated to be long-term (consolidation). The maximum differential settlement across the length of the proposed retaining walls is estimated to range from about 0.10% to 0.13%. A summary of the results of our settlement analysis along each of the proposed wall alignments, including total settlement, long-term settlement and differential settlement is included within Table 8 below. Based on the results of our analysis, it is our opinion that the estimated settlement magnitudes are not anticipated to be a concern as the elastic settlement is anticipated to occur immediately and approximately 90 percent of consolidation settlement is expected to be complete within the first 30 days following construction. Additionally, differential settlement is estimated to be less than the limit for rigid semi-gravity walls per ODOT BDM Section 307.1.6. The output of the settlement analysis program is included within Appendix 3D.

Table 8: Settlement Analysis Summary

Retaining Wall	RW-1	RW-2	RW-3	RW-4	RW-5	RW-6
Elastic Settlement (inches)	0.8	0.5	0.7	0.6	0.3	0.8
Consolidation Settlement (inches)	1.5	0.2	0.9	1.2	1.0	1.5
Total Settlement (inches)	2.3	0.7	1.6	1.8	1.3	2.3
Differential Settlement ⁽¹⁾ (%)	0.12	0.10	0.10	0.12	0.13	0.12

Notes:
1. Estimated along length of wall (longitudinal direction) per ODOT BDM Section 307.1.6.

Furthermore, as a pile foundation is planned at the rear abutment of the proposed pedestrian Bridge GRE-68-BK80020-00.492 over Oldtown Creek, long-term settlement resulting from the retaining wall and embankment induced loading was estimated at the referenced bridge foundation location to evaluate whether the long-term settlement may have an impact (i.e., downdrag) on the planned pile foundations. Based on our settlement analysis, the maximum long-term settlement at the proposed rear abutment pile locations was estimated to be about 0.1 inches. This estimated magnitude is not anticipated to be an issue as it is less than 0.4 inches of long-term (consolidation) settlement (i.e., the threshold at which downdrag loading should be considered per ODOT BDM Sections 305.3.2.2 and 305.4.1.2 “Downdrag and Drag Load”).

3.3.6. Temporary Excavations

It is recommended that all temporary excavations comply with the most recent Occupational Safety and Health Administration (OSHA) Excavating and Trenching Standard, Title 29 of the Code of Federal Regulation (CFR) Part 1926, Subpart P. The contractor is responsible for designing and constructing stable,

Structure Foundation Exploration Report
Proposed Retaining Walls
GRE-68-12.65
Greene County, Ohio
PID: 115388

temporary excavations and should shore, slope, or bench the sides of the excavations as required to maintain stability of both the excavation sides and bottom. Per Title 29 CFR Part 1926, the contractor's competent person should evaluate the soil exposed in the excavations as part of their safety procedures. In no case should slope height, slope inclination, or excavation depth, including utility trench excavation depth, exceed those specified in local, state, and federal safety regulations. Based on the natural soils encountered at the site (Type B Soil), it is recommended that temporary excavation slopes (exceeding a depth of 3 ft and less than 20 ft) be laid back to at least 1H:1V and these slopes should be braced or backfilled if the excavation slope will be maintained for more than a day.

3.3.7. Drainage Considerations

It is recommended that adequate drainage is maintained/controlled during and after construction of the retaining wall, and that trail/roadway drainage is carefully controlled around the wall location in order to prevent ponding, erosion of retained backfill soil, loss of shear strength of foundation soils due to saturation, and other drainage related issues.

It is recommended that internal drainage of the retaining wall be designed to provide positive drainage behind the wall and limit the buildup of hydrostatic pressure. Furthermore, it is recommended that the barrier or curb at the roadway extend at least 25 ft beyond wall limits, and outlet to a piped collection system (i.e., collection basin/inlet) located beyond the extents of the wall. Where a barrier or curb is not present, it is recommended that a paved channel (swale) be placed directly behind the top of the wall. The paved channel should be designed to intercept surface water and direct it to an outlet as well as reduce the potential for surface water from overtopping the wall. The designer should anticipate and address in design and detailing the possibility of water runoff from extreme events which will overtop the drainage swale and run down the wall face.

APPENDIX 3A

GENERALIZED SUBSURFACE PROFILE



**OHIO DEPARTMENT OF TRANSPORTATION
OFFICE OF GEOTECHNICAL ENGINEERING**

CLIENT Carpenter Marty Transportation

PROJECT NUMBER 115388

PROJECT NAME GRE-68-12.65

PROJECT LOCATION Orlidown, OH (Greene County)

SUBSURFACE DIAGRAM

- Ohio DOT: A-1-b, gravel and/or stone fragments with sand and fine sand
- Ohio DOT: A-2-a, gravel and/or stone fragments
- Ohio DOT: A-2-b, silt and/or stone fragments
- Ohio DOT: A-3-a, coarse sand and fine sand
- Ohio DOT: A-3-b, silt and/or stone fragments
- Ohio DOT: A-4-a, sandy silt
- Ohio DOT: A-4-b, silty clay
- Ohio DOT: A-5-a, clay
- Ohio DOT: A-7-a, gravel and/or stone fragments
- Ohio DOT: A-7-b, silt
- Ohio DOT: A-7-c, clay

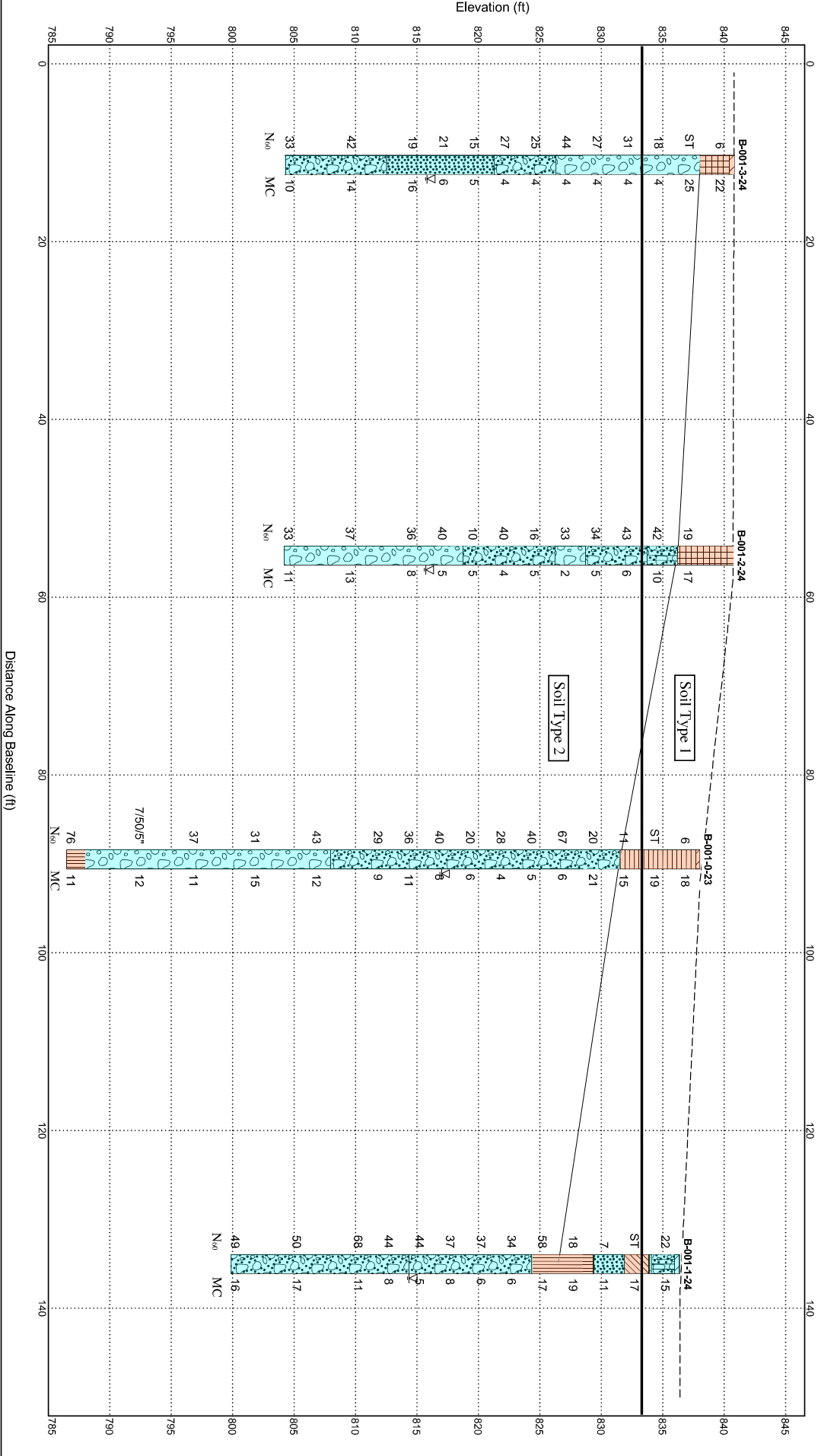

Distance Along Baseline (ft)

APPENDIX 3B

EXTERNAL STABILITY ANALYSIS

RETAINING WALL 1

Objective: To evaluate the external stability of CIP wall's with level backfill (no backslope).
Method: In accordance with ODOT Bridge Design Manual, 2024 [Sect. 307] LRFD Bridge Design Specifications, 8th Ed., Nov. 2017, [Sect. 11.6.1, Sect. 11.6.2, and Sect. 11.6.3].

Givens:

Backfill Soil Design Parameters:

$$\phi'_f := 30 \text{ deg}$$

Effective angle of internal friction

$$\gamma_f := 120 \frac{\text{lb}}{\text{ft}^3}$$

Unit weight

$$c'_f := 0 \frac{\text{lb}}{\text{ft}^2}$$

Effective Cohesion

$$\delta := 0.67 \cdot \phi'_f$$

$$\delta = 20.1 \text{ deg}$$

Friction angle between backfill and wall taken as specified in **LRFD BDS C3.11.5.3 (degrees)**

Foundation Soil Design Parameters:

Drained Conditions (Effective Stress):

$$\phi'_{fd} := 22 \text{ deg}$$

Effective angle of internal friction

$$\gamma_{fd} := 125 \frac{\text{lb}}{\text{ft}^3}$$

Unit weight

$$c'_{fd} := 205 \frac{\text{lb}}{\text{ft}^2}$$

Effective Cohesion

$$\delta_{fd} := 0.67 \cdot \phi'_{fd}$$

$$\delta_{fd} = 14.7 \text{ deg}$$

Friction angle between foundation soils and footing taken as specified in **LRFD BDS C3.11.5.3 (degrees)**

Undrained Conditions (Total Stress):

$$\phi_{fdu} := 0 \text{ deg}$$

Angle of internal friction (Same as Drained Conditions if granular soils)

$$\gamma_{fd} = 125 \frac{\text{lb}}{\text{ft}^3}$$

Unit weight

$$Su_{fdu} := 2100 \frac{\text{lb}}{\text{ft}^2}$$

Undrained Shear Strength

$$\delta_{fdu} := 0.67 \cdot \phi_{fdu}$$

$$\delta_{fdu} = 0 \text{ deg}$$

Friction angle between foundation soils and footing taken as specified in **LRFD BDS C3.11.5.3 (degrees)**

Foundation Surcharge Soil Parameters:

$$\gamma_q := 120 \frac{\text{lb}}{\text{ft}^3}$$

Unit weight of Soil above bearing depth (Used in Bearing Resistance of Soil Calculation **LRFD 10.6.3.1.2a-1**)

Other Parameters:

$$\gamma_c := 150 \frac{\text{lb}}{\text{ft}^3}$$

Concrete Unit weight

$$\gamma_p := 150 \frac{\text{lb}}{\text{ft}^3}$$

Pavement Unit weight

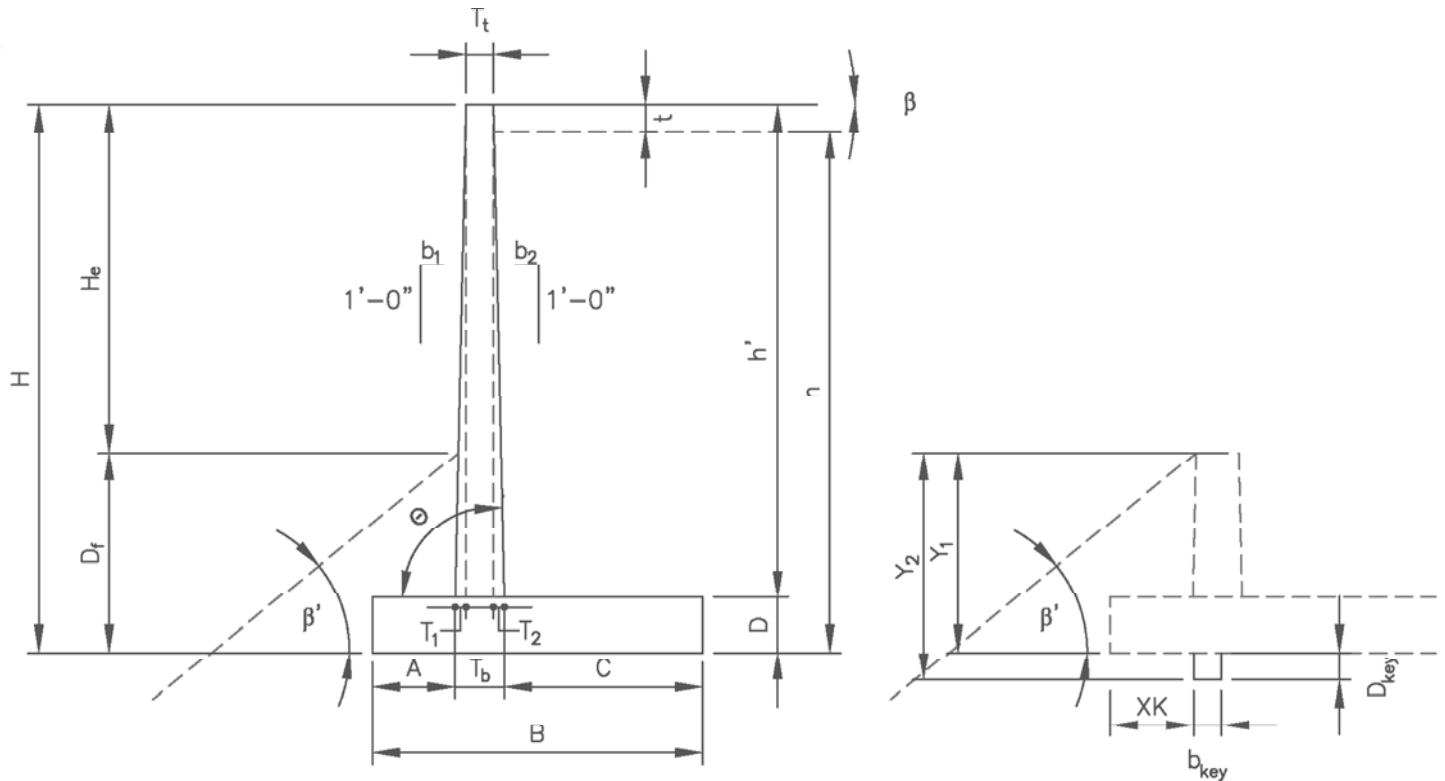

Wall Geometry:

$H_e := 17.8 \text{ ft}$

$D_f := 3.5 \text{ ft}$

$H := H_e + D_f$

$H = 21.3 \text{ ft}$

$T_t := 1.0 \text{ ft}$

$b_1 := 1.55 \cdot \left(\frac{\text{in}}{\text{ft}}\right)$

$b_2 := 0 \cdot \left(\frac{\text{in}}{\text{ft}}\right)$

$\beta := 0 \text{ deg}$

$\beta' := 0 \text{ deg}$

$t := 0.5 \cdot \text{ft}$

- Inclination of ground slope:
- Horizontal: **0**
 - 3H:1V: **18.435**
 - 2H:1V: **26.565**
 - 1.5H:1V: **33.690**

Exposed wall height

Footing cover at Toe

Note: Where the potential for scour, erosion of undermining exists, spread footings shall be located to bear below the maximum depth of scour or undermining. Spread footings shall be located below the depth of potential frost. **LRFD BDS 10.6.1.2.**

Design Wall Height

Stem thickness at top of wall

Frontwall batter, (b1H:12V)

Backwall batter, (b2H:12V)

Inclination of ground slope behind face of wall.
Horizontal backfill behind CIP wall, $\beta = 0 \text{ deg}$

Inclination of ground slope in front of wall. If it is horizontal backfill in front of CIP wall, $\beta' = 0 \text{ deg}$. A negative angle (-) indicates grades slope up from front of wall. Positive angle (+) indicates grade slope down from wall as shown in above figure.

Pavement thickness

Preliminary Wall Dimensioning:

$B := 17 \text{ ft}$	$\frac{2}{5} \cdot H = 8.52 \text{ ft}$ to $\frac{3}{5} \cdot H = 12.78 \text{ ft}$	Footing base width (2/5H to 3/5H)
$A := 1.5 \text{ ft}$	$\frac{H}{8} = 2.66 \text{ ft}$ to $\frac{H}{5} = 4.26 \text{ ft}$	Toe projection (H/8 to H/5)
$D := 2 \text{ ft}$	$\frac{H}{8} = 2.66 \text{ ft}$ to $\frac{H}{5} = 4.26 \text{ ft}$	Footing thickness (H/8 to H/5)

Shear Key Dimensioning:

$D_{key} := 0 \text{ ft}$	Depth of shear key from bottom of footing Note: Footings on rock typically require shear key
$b_{key} := 0 \text{ ft}$	Width of shear key
$XK := A$	Distance from toe to shear key

Other Wall Dimensions:

$h' := H - D$	$h' = 19.3 \text{ ft}$	Stem height
$T_1 := b_1 \cdot h'$	$T_1 = 2.493 \text{ ft}$	Stem front batter width
$T_2 := b_2 \cdot h'$	$T_2 = 0 \text{ ft}$	Stem back batter width
$T_b := T_1 + T_2 + T_t$	$T_b = 3.493 \text{ ft}$	Stem thickness at bottom of wall
$C := B - A - T_b$	$C = 12.007 \text{ ft}$	Heel projection
$\theta := 90 \text{ deg}$		Angle of back face of wall to horizontal = $atan(12/b_2)$
$b := 12 \text{ in}$	$b = 1 \text{ ft}$	Concrete strip width (for design)
$y_1 := 3.5 \cdot \text{ft}$	$y_1 = 3.5 \text{ ft}$	Depth to where passive pressure may begin to be utilized in front of wall. (Typically Df)
$y_2 := D_f + D_{key}$	$y_2 = 3.5 \text{ ft}$	Bottom of shear key/footing depth i.e. depth to where passive pressure may no longer be utilized.
$h := H - t$	$h = 20.8 \text{ ft}$	Height of retained fill at back of heel

Live Load Surcharge Parameters:

$\lambda := 20 \text{ ft}$	Horizontal distance from the back of the wall to point of traffic surcharge load
$SUR := \text{if} \left(\lambda < \frac{H}{2}, 250 \frac{\text{lb}}{\text{ft}^2}, 100 \frac{\text{lb}}{\text{ft}^2} \right) = 100 \frac{\text{lb}}{\text{ft}^2}$	Live load surcharge (per LRFD BDS [3.11.6.4]) Note: If vehicular loading is within 1 ft of the backface of the wall and with a design height, H, less than 20 ft, see LRFD BDS Section 3.11.6.4 and Table 3.11.6.4-2 for adjusted surcharge load calculation. Note: when $\lambda < H/2$, SUR equal 100 psf to account for construction loads

Calculations:

Earth Pressure Coefficients:

Backfill Active Earth:

$$\Gamma := \left(1 + \sqrt{\frac{(\sin(\phi'_f + \delta) \cdot \sin(\phi'_f - \beta))}{(\sin(\theta - \delta) \cdot \sin(\theta + \beta))}} \right)^2 \quad \Gamma = 2.687$$

$$k_{af} := \left(\frac{(\sin(\theta + \phi'_f))^2}{(\Gamma \cdot (\sin(\theta))^2 \cdot \sin(\theta - \delta))} \right) \quad k_{af} = 0.297 \quad \text{Active Earth Pressure Coefficient (per LRFD Sect. 3.11.5.3)}$$

Foundation Soil Passive Earth:

Drained Conditions assuming ($\phi'_{fd} > 0$):

Input Parameters for **LRFD Figure 3.11.5.4-2**, assumes $\theta = 90$ degrees

$$\frac{-\beta'}{\phi'_{fd}} = 0$$

$$\frac{-\delta_{fd}}{\phi'_{fd}} = -0.67$$

$$k'_p := 3.54$$

Passive Earth Pressure Coefficient from **LRFD Figure 3.11.5.4-2**

Determine Reduction Factor (R) by interpolation:

$$R_d := 0.828$$

Reduction Factor

$$k_{pd} := R_d \cdot k'_p \quad k_{pd} = 2.931$$

Passive Earth Pressure Coefficient for Drained Conditions

Undrained Conditions ($\phi'_{fdu} > 0$): **Note:** Expand window below to complete calculation

Undrained Conditions:

$$k_{pu} := \text{if}(\phi'_{fdu} > 0, k_{pu}, 1) \quad k_{pu} = 1$$

Passive Earth Pressure Coefficient for Resistance Undrained Conditions

Compute Unfactored Loads LRFD [Tables 3.4.1-1 and 3.4.1-2]:

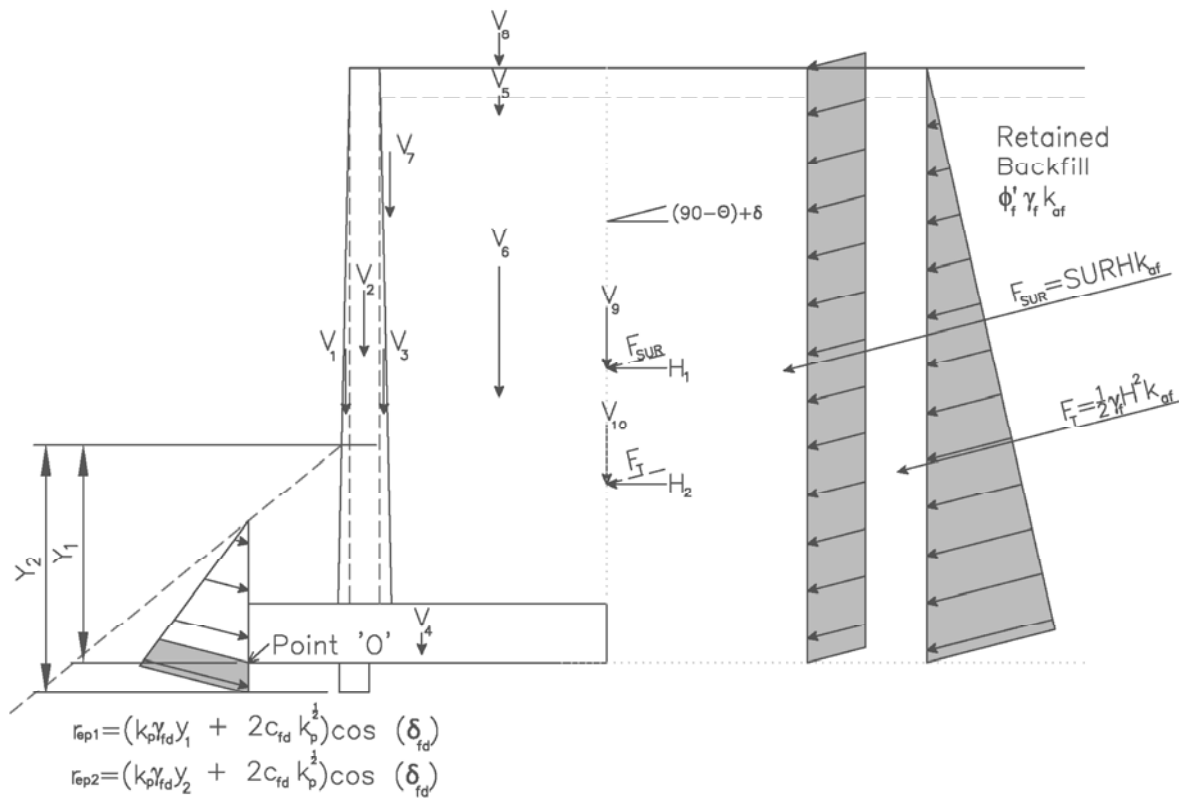

$$F_T := \frac{1}{2} \cdot \gamma_f \cdot H^2 \cdot k_{af}$$

$$F_T = 8091.8 \frac{\text{lb} \cdot \text{ft}}{\text{ft}}$$

Active Earth Force Resultant (EH)

$$F_{SUR} := SUR \cdot H \cdot k_{af}$$

$$F_{SUR} = 633.2 \frac{\text{lb} \cdot \text{ft}}{\text{ft}}$$

Live Load Surcharge (LS)

Vertical Loads:

$$V_1 := \frac{1}{2} \cdot T_1 \cdot h' \cdot \gamma_c$$

$$V_1 = 3608.5 \frac{\text{lb} \cdot \text{ft}}{\text{ft}}$$

Wall stem front batter (DC)

$$V_2 := T_1 \cdot h' \cdot \gamma_c$$

$$V_2 = 2895 \frac{\text{lb} \cdot \text{ft}}{\text{ft}}$$

Wall stem (DC)

$$V_3 := \frac{1}{2} \cdot T_2 \cdot h' \cdot \gamma_c$$

$$V_3 = 0 \frac{\text{lb} \cdot \text{ft}}{\text{ft}}$$

Wall stem back batter (DC)

$$V_4 := D \cdot B \cdot \gamma_c$$

$$V_4 = 5100 \frac{\text{lb} \cdot \text{ft}}{\text{ft}}$$

Wall Footing (DC)

$$V_5 := t \cdot (T_2 + C) \cdot \gamma_p$$

$$V_5 = 900.5 \frac{\text{lb} \cdot \text{ft}}{\text{ft}}$$

Pavement (DC)

$$V_6 := C \cdot (h' - t) \cdot \gamma_f$$

$$V_6 = 27088 \frac{\text{lb} \cdot \text{ft}}{\text{ft}}$$

Soil Backfill - Heel (EV)

$$V_7 := \frac{1}{2} \cdot b_2 \cdot (h' - t)^2 \cdot \gamma_f$$

$$V_7 = 0 \frac{\text{lb} \cdot \text{ft}}{\text{ft}}$$

Soil Backfill - Batter (EV)

$$V_8 := SUR \cdot (T_2 + C)$$

$$V_8 = 1200.7 \frac{\text{lb} \cdot \text{ft}}{\text{ft}}$$

Live Load Surcharge above Heel- (LS)
- Strength lb

$$V_9 := F_{SUR} \cdot \sin(90 \cdot \text{deg} - \theta + \delta)$$

$$V_9 = 217.6 \frac{\text{lb} \cdot \text{ft}}{\text{ft}}$$

Live Load Surcharge Resultant (vertical comp. - LS)
- Strength la

$$V_{10} := F_T \cdot \sin(90 \cdot \text{deg} - \theta + \delta)$$

$$V_{10} = 2780.8 \frac{\text{lb} \cdot \text{ft}}{\text{ft}}$$

Active earth force resultant (vertical component - EH)

Moment Arm:

Moments produced from vertical loads about Point 'O'

$$d_{v1} := A + \frac{2}{3} \cdot T_1 = 3.2 \text{ ft}$$

$$d_{v2} := A + T_1 + \frac{T_1}{2} = 4.5 \text{ ft}$$

$$d_{v3} := A + T_1 + T_1 + \frac{T_2}{3} = 5 \text{ ft}$$

$$d_{v4} := \frac{B}{2} = 8.5 \text{ ft}$$

$$d_{v5} := B - \frac{T_2 + C}{2} = 11 \text{ ft}$$

$$d_{v6} := B - \frac{C}{2} = 11 \text{ ft}$$

$$d_{v7} := A + T_1 + T_1 + \left(\frac{2}{3} \cdot b_2 \cdot (h' - t) \right) = 5 \text{ ft}$$

$$d_{v8} := B - \frac{T_2 + C}{2} = 11 \text{ ft}$$

$$d_{v9} := B = 17 \text{ ft}$$

$$d_{v10} := B = 17 \text{ ft}$$

Moment:

$$MV_1 := V_1 \cdot d_{v1} = 11409.9 \text{ lbf}$$

$$MV_2 := V_2 \cdot d_{v2} = 13007 \text{ lbf}$$

$$MV_3 := V_3 \cdot d_{v3} = 0 \text{ lbf}$$

$$MV_4 := V_4 \cdot d_{v4} = 43350 \text{ lbf}$$

$$MV_5 := V_5 \cdot d_{v5} = 9902.7 \text{ lbf}$$

$$MV_6 := V_6 \cdot d_{v6} = 297871.8 \text{ lbf}$$

$$MV_7 := V_7 \cdot d_{v7} = 0 \text{ lbf}$$

$$MV_8 := V_8 \cdot d_{v8} = 13203.5 \text{ lbf}$$

$$MV_9 := V_9 \cdot d_{v9} = 3699.1 \text{ lbf}$$

$$MV_{10} := V_{10} \cdot d_{v10} = 47274.2 \text{ lbf}$$

Horizontal Loads:

$$H_1 := F_{SUR} \cdot \cos(90 \cdot \text{deg} - \theta + \delta) \quad H_1 = 594.6 \frac{\text{lbf}}{\text{ft}}$$

$$H_2 := F_T \cdot \cos(90 \cdot \text{deg} - \theta + \delta) \quad H_2 = 7599 \frac{\text{lbf}}{\text{ft}}$$

Live Load Surcharge Resultant (horizontal comp. - LS)

Active Earth Force Resultant (horizontal comp. - EH)

Moment Arm:

$$d_{h1} := \frac{H}{2} \quad d_{h1} = 10.7 \text{ ft}$$

$$d_{h2} := \frac{H}{3} \quad d_{h2} = 7.1 \text{ ft}$$

Moment:

$$MH_1 := H_1 \cdot d_{h1} \quad MH_1 = 6332.5 \frac{\text{lbf} \cdot \text{ft}}{\text{ft}}$$

$$MH_2 := H_2 \cdot d_{h2} \quad MH_2 = 53952.9 \frac{\text{lbf} \cdot \text{ft}}{\text{ft}}$$

Unfactored Loads by Load Type:

$$V_{DC} := V_1 + V_2 + V_3 + V_4 + V_5 \quad V_{DC} = 12504 \frac{\text{lbf}}{\text{ft}}$$

$$V_{LS_1a} := V_9 \quad V_{LS_1a} = 217.6 \frac{\text{lbf}}{\text{ft}}$$

$$V_{EH} := V_{10} \quad V_{EH} = 2780.8 \frac{\text{lbf}}{\text{ft}}$$

$$H_{EH} := H_2 \quad H_{EH} = 7599 \frac{\text{lbf}}{\text{ft}}$$

$$V_{EV} := V_6 + V_7 \quad V_{EV} = 27088 \frac{\text{lbf}}{\text{ft}}$$

$$V_{LS_1b} := V_8 + V_9 \quad V_{LS_1b} = 1418.3 \frac{\text{lbf}}{\text{ft}}$$

$$H_{LS} := H_1 \quad H_{LS} = 594.6 \frac{\text{lbf}}{\text{ft}}$$

Unfactored Moments by Load Type

$M_{DC} := MV_1 + MV_2 + MV_3 + MV_4 + MV_5$	$M_{DC} = 77669.5 \frac{\text{lb} \cdot \text{ft}}{\text{ft}}$
$M_{EV} := MV_6 + MV_7$	$M_{EV} = 297871.8 \frac{\text{lb} \cdot \text{ft}}{\text{ft}}$
$M_{LSV_Ia} := MV_9$	$M_{LSV_Ia} = 3699.1 \frac{\text{lb} \cdot \text{ft}}{\text{ft}}$
$M_{LSV_Ib} := MV_8 + MV_9$	$M_{LSV_Ib} = 16902.6 \frac{\text{lb} \cdot \text{ft}}{\text{ft}}$
$M_{EH1} := MV_{10}$	$M_{EH1} = 47274.2 \frac{\text{lb} \cdot \text{ft}}{\text{ft}}$
$M_{LSH} := MH_1$	$M_{LSH} = 6332.5 \frac{\text{lb} \cdot \text{ft}}{\text{ft}}$
$M_{EH2} := MH_2$	$M_{EH2} = 53952.9 \frac{\text{lb} \cdot \text{ft}}{\text{ft}}$

Load Combination Limit States:

$\eta := 1$ LRFD Load Modifier

Strength Limit State I: EV(min) = 1.00 EV(max) = 1.35
EH(min) = 0.90 EH(max) = 1.50
LS = 1.75

Strength Limit State Ia: (Sliding and Eccentricity)	$Ia_{DC} := 0.9$	$Ia_{EV} := 1$	$Ia_{EH} := 1.5$	$Ia_{LS} := 1.75$
Strength Limit State Ib: (Bearing Capacity)	$Ib_{DC} := 1.25$	$Ib_{EV} := 1.35$	$Ib_{EH} := 1.5$	$Ib_{LS} := 1.75$

Factored Vertical Loads by Limit State:

$V_{Ia} := \eta \cdot ((Ia_{DC} \cdot V_{DC}) + (Ia_{EV} \cdot V_{EV}) + (Ia_{EH} \cdot V_{EH}) + (Ia_{LS} \cdot V_{LS_Ia}))$	$V_{Ia} = 42893.6 \frac{\text{lb}}{\text{ft}}$
$V_{Ib} := \eta \cdot ((Ib_{DC} \cdot V_{DC}) + (Ib_{EV} \cdot V_{EV}) + (Ib_{EH} \cdot V_{EH}) + (Ib_{LS} \cdot V_{LS_Ib}))$	$V_{Ib} = 58852.1 \frac{\text{lb}}{\text{ft}}$

Factored Horizontal Loads by Limit State:

$H_{Ia} := \eta \cdot ((Ia_{LS} \cdot H_{LS}) + (Ia_{EH} \cdot H_{EH}))$	$H_{Ia} = 12439 \frac{\text{lb}}{\text{ft}}$
$H_{Ib} := \eta \cdot ((Ib_{LS} \cdot H_{LS}) + (Ib_{EH} \cdot H_{EH}))$	$H_{Ib} = 12439 \frac{\text{lb}}{\text{ft}}$

Factored Moments Produced by Vertical Loads by Limit State:

$MV_{Ia} := \eta \cdot ((Ia_{DC} \cdot M_{DC}) + (Ia_{EV} \cdot M_{EV}) + (Ia_{EH} \cdot M_{EH1}) + (Ia_{LS} \cdot M_{LSV_Ia}))$	$MV_{Ia} = 445159.1 \frac{\text{lb} \cdot \text{ft}}{\text{ft}}$
$MV_{Ib} := \eta \cdot ((Ib_{DC} \cdot M_{DC}) + (Ib_{EV} \cdot M_{EV}) + (Ib_{EH} \cdot M_{EH1}) + (Ib_{LS} \cdot M_{LSV_Ib}))$	$MV_{Ib} = 599704.8 \frac{\text{lb} \cdot \text{ft}}{\text{ft}}$

Factored Moments Produced by Horizontal Loads by Limit State:

$MH_{Ia} := \eta \cdot ((Ia_{LS} \cdot M_{LSH}) + (Ia_{EH} \cdot M_{EH2}))$	$MH_{Ia} = 92011.2 \frac{\text{lb} \cdot \text{ft}}{\text{ft}}$
$MH_{Ib} := \eta \cdot ((Ib_{LS} \cdot M_{LSH}) + (Ib_{EH} \cdot M_{EH2}))$	$MH_{Ib} = 92011.2 \frac{\text{lb} \cdot \text{ft}}{\text{ft}}$

Compute Bearing Resistance:

Compute the resultant location about the toe of the base length (distance from "O") Strength lb:

$\Sigma M_R := MV_{lb}$	$\Sigma M_R = 599704.8 \frac{lb \cdot ft}{ft}$	Sum of Resisting Moments (Strength lb)
$\Sigma M_O := MH_{lb}$	$\Sigma M_O = 92011.2 \frac{lb \cdot ft}{ft}$	Sum of Overturning Moments (Strength lb)
$\Sigma V := V_{lb}$	$\Sigma V = 58852.1 \frac{lb}{ft}$	Sum of Vertical Loads (Strength lb)
$x := \frac{(\Sigma M_R - \Sigma M_O)}{\Sigma V}$	$x = 8.6 \text{ ft}$	Distance from Point "O" the resultant intersects the base

$e := \left \frac{B}{2} - x \right $	$e = 0.13 \text{ ft}$	Wall eccentricity, Note: The vertical stress is assumed to be uniformly distributed over the effective bearing width, B', since the wall is supported by a soil foundation LRFD [11.6.3.2] . The effective bearing width is equal to B-2e. When the foundation eccentricity is negative the absolute value is used.
---------------------------------------	-----------------------	---

Foundation Layout:

$B' := B - 2 \cdot e$	$B' = 16.7 \text{ ft}$	Effective Footing Width
$L' := 110 \text{ ft}$		Effective Footing Length (Assumed)
$H' := H_{lb}$	$H' = 12439 \frac{lb}{ft}$	Summation of Horizontal Loads (Strength lb)
$V' := V_{lb}$	$V' = 58852.1 \frac{lb}{ft}$	Summation of Vertical Loads (Strength lb)
$D_f = 3.5 \text{ ft}$		Footing embedment
$d_w := 0 \text{ ft}$		Depth of Groundwater below ground surface at front of wall.

Drained Conditions (Effective Stress):

$N_q := \text{if} \left(\phi'_{fd} > 0, e^{\pi \cdot \tan(\phi'_{fd})} \cdot \tan \left(45 \text{ deg} + \frac{\phi'_{fd}}{2} \right), 1.0 \right)$	$N_q = 7.82$
$N_c := \text{if} \left(\phi'_{fd} > 0, \frac{N_q - 1}{\tan(\phi'_{fd})}, 5.14 \right)$	$N_c = 16.88$
$N_\gamma := 2 \cdot (N_q + 1) \cdot \tan(\phi'_{fd})$	$N_\gamma = 7.1$

Compute shape correction factors per LRFD [Table 10.6.3.1.2a-3]:

$s_c := \text{if} \left(\phi'_{fd} > 0, 1 + \left(\frac{B'}{L'} \right) \cdot \left(\frac{N_q}{N_c} \right), 1 + \left(\frac{B'}{5 \cdot L'} \right) \right)$	$s_c = 1.071$
$s_q := \text{if} \left(\phi'_{fd} > 0, 1 + \left(\frac{B'}{L'} \cdot \tan(\phi'_{fd}) \right), 1 \right)$	$s_q = 1.062$
$s_\gamma := \text{if} \left(\phi'_{fd} > 0, 1 - 0.4 \cdot \left(\frac{B'}{L'} \right), 1 \right)$	$s_\gamma = 0.939$

Load inclination factors:

$$i_q := 1$$

$$i_\gamma := 1$$

$$i_c := 1$$

Assumed to be 1.0, see **LRFD BDS C10.6.3.1.2a**.
"Most geotechnical engineers do not use the load inclination factors". If desired, use LRFD Equations [10.6.3.1.2a-5] thru [10.6.3.1.2a-9].

Compute groundwater depth correction factors per LRFD [Table 10.6.3.1.2a-2]:

$$C_{wq} := \text{if}(d_w \geq D_f, 1.0, 0.5) \quad C_{wq} = 0.5$$

$$C_{wy} := \text{if}(d_w \geq (1.5 \cdot B) + D_f, 1.0, 0.5) \quad C_{wy} = 0.5$$

Depth Correction Factor per Hanson (1970):

$$d_q := \text{if}\left(\frac{D_f}{B} \leq 1, 1 + 2 \cdot \tan(\phi'_{fd}) \cdot (1 - \sin(\phi'_{fd}))^2 \cdot \frac{D_f}{B}, 1 + 2 \cdot \tan(\phi'_{fd}) \cdot (1 - \sin(\phi'_{fd}))^2 \cdot \text{atan}\left(\frac{D_f}{B}\right)\right)$$

$$d_q = 1.07$$

Compute modified bearing capacity factors LRFD [Equation 10.6.3.1.2a-2 to 10.6.3.1.2a-4]:

$$N_{cm} := N_c \cdot s_c \cdot i_c \quad N_{cm} = 18.074$$

$$N_{qm} := N_q \cdot s_q \cdot i_q \quad N_{qm} = 8.302$$

$$N_{\gamma m} := N_\gamma \cdot s_\gamma \cdot i_\gamma \quad N_{\gamma m} = 6.694$$

Compute nominal bearing resistance. LRFD [Eq 10.6.3.1.2a-1]:

$$q_{nd} := c'_{fd} \cdot N_{cm} + \gamma_{fd} \cdot D_f \cdot N_{qm} \cdot d_q \cdot C_{wq} + 0.5 \cdot \gamma_{fd} \cdot B' \cdot N_{\gamma m} \cdot C_{wy} \quad q_{nd} = 9142.5 \frac{\text{lb}}{\text{ft}^2}$$

Compute factored bearing resistance. LRFD [Eq 10.6.3.1.1]:

$$\phi_b := .55$$

Bearing resistance factor LRFD Table 11.5.7-1.

$$q_{Rd} := \phi_b \cdot q_{nd}$$

$$q_{Rd} = 5 \text{ ksf}$$

Factored bearing resistance Drained Conditions

Undrained Conditions (Effective Stress):

$$N_q := \text{if}\left(\phi_{fd} > 0, e^{\pi \cdot \tan(\phi_{fd})} \cdot \tan\left(45 \text{ deg} + \frac{\phi_{fd}}{2}\right), 1.0\right) \quad N_q = 1$$

$$N_c := \text{if}\left(\phi_{fd} > 0, \frac{N_q - 1}{\tan(\phi_{fd})}, 5.14\right) \quad N_c = 5.14$$

$$N_\gamma := 2 \cdot (N_q + 1) \cdot \tan(\phi_{fd}) \quad N_\gamma = 0$$

Compute shape correction factors per LRFD [Table 10.6.3.1.2a-3]:

$$s_c := \text{if} \left(\phi_{fd} > 0, 1 + \left(\frac{B'}{L'} \right) \cdot \left(\frac{N_q}{N_c} \right), 1 + \left(\frac{B'}{5 \cdot L'} \right) \right) \quad s_c = 1.03$$

$$s_q := \text{if} \left(\phi_{fd} > 0, 1 + \left(\frac{B'}{L'} \right) \cdot \tan(\phi_{fd}), 1 \right) \quad s_q = 1$$

$$s_\gamma := \text{if} \left(\phi_{fd} > 0, 1 - 0.4 \cdot \left(\frac{B'}{L'} \right), 1 \right) \quad s_\gamma = 1$$

Load inclination factors:

$$i_q := 1$$

$$i_\gamma := 1$$

$$i_c := 1$$

Assumed to be 1.0, see LRFD BDS C10.6.3.1.2a.
"Most geotechnical engineers do not use the load inclination factors". If desired, use LRFD Equations [10.6.3.1.2a-5] thru [10.6.3.1.2a-9].

Compute modified bearing capacity factors LRFD [Equation 10.6.3.1.2a-2 to 10.6.3.1.2a-4]:

$$N_{cm} := N_c \cdot s_c \cdot i_c \quad N_{cm} = 5.297$$

$$N_{qm} := N_q \cdot s_q \cdot i_q \quad N_{qm} = 1$$

$$N_{\gamma m} := N_\gamma \cdot s_\gamma \cdot i_\gamma \quad N_{\gamma m} = 0$$

Depth Correction Factor per Hanson (1970):

$$d_q := \text{if} \left(\frac{D_f}{B} \leq 1, 1 + 2 \cdot \tan(\phi_{fd}) \cdot (1 - \sin(\phi_{fd}))^2 \cdot \frac{D_f}{B}, 1 + 2 \cdot \tan(\phi_{fd}) \cdot (1 - \sin(\phi_{fd}))^2 \cdot \text{atan} \left(\frac{D_f}{B} \right) \right)$$

$$d_q = 1$$

Compute nominal bearing resistance. LRFD [Eq 10.6.3.1.2a-1]:

$$q_{nu} := Su_{fd} \cdot N_{cm} + \gamma_{fd} \cdot D_f \cdot N_{qm} \cdot d_q \cdot C_{wq} + 0.5 \cdot \gamma_{fd} \cdot B' \cdot N_{\gamma m} \cdot C_{w\gamma} \quad q_{nu} = 11341.4 \frac{\text{lbf}}{\text{ft}^2}$$

Compute factored bearing resistance. LRFD [Eq 10.6.3.1.1]:

$$\phi_b := .55$$

$$q_{Ru} := \phi_b \cdot q_{nu} \quad q_{Ru} = 6.2 \text{ ksf}$$

Bearing resistance factor LRFD Table 11.5.7-1.

Factored bearing resistance Undrained Conditions

Factored Bearing Resistance Drained vs. Undrained Conditions:

Drained Conditions: $q_{Rd} = 5 \text{ ksf}$

Undrained Conditions: $q_{Ru} = 6.2 \text{ ksf}$

Evaluate External Stability of Wall:

Compute the ultimate bearing stress :

$$e = 0.13 \text{ ft}$$

$$\sigma_V := \frac{\Sigma V}{B - 2 \cdot e} \quad \sigma_V = 3.514 \text{ ksf}$$

Bearing Capacity:Demand Ratio (CDR)

Drained Conditions:	$CDR_{Bearing_D} := \frac{q_{Rd}}{\sigma_V}$	Is the CDR > or = to 1.0?	$CDR_{Bearing_D} = 1.43$
---------------------	---	---------------------------	---------------------------

Undrained Conditions:	$CDR_{Bearing_U} := \frac{q_{Ru}}{\sigma_V}$	Is the CDR > or = to 1.0?	$CDR_{Bearing_U} = 1.78$
-----------------------	---	---------------------------	---------------------------

Limiting Eccentricity at Base of Wall (Strength Ia):

Compute the resultant location about the toe "O" of the base length (distance from Pivot):

$$e_{max} := \frac{B}{3}$$

$$e_{max} = 5.7 \text{ ft}$$

Maximum Eccentricity **LRFD [11.6.3.3.]**
Equals B/3 for soil.

$$\Sigma M_R := MV_{Ia}$$

$$\Sigma M_R = 445159.1 \frac{\text{lb} \cdot \text{ft}}{\text{ft}}$$

Sum of Resisting Moments (Strength Ia)

$$\Sigma M_O := MH_{Ia}$$

$$\Sigma M_O = 92011.2 \frac{\text{lb} \cdot \text{ft}}{\text{ft}}$$

Sum of Overturning Moments (Strength Ia)

$$\Sigma V := V_{Ia}$$

$$\Sigma V = 42893.6 \frac{\text{lb}}{\text{ft}}$$

Sum of Vertical Loads (Strength Ia)

$$x := \frac{(\Sigma M_R - \Sigma M_O)}{\Sigma V}$$

$$x = 8.2 \text{ ft}$$

Distance from Point "O" the resultant intersects the base

$$e := \text{abs} \left(\frac{B}{2} - x \right)$$

$$e = 0.27 \text{ ft}$$

Wall eccentricity, **Note:** The vertical stress is assumed to be uniformly distributed over the effective bearing width, B', since the wall is supported by a soil foundation **LRFD [11.6.3.2]**. The effective bearing width is equal to B-2e. .

Eccentricity Capacity:Demand Ratio (CDR)

$$CDR_{Eccentricity} := \frac{e_{max}}{e}$$

Is the CDR > or = to 1.0?

$$CDR_{Eccentricity} = 21.23$$

Sliding Resistance at Base of Wall LRFD [10.6.3.4]:

Factored Sliding Force (Strength Ia):

$$R_u := H_{Ia} \qquad R_u = 12439 \frac{\text{lb}f}{\text{ft}}$$

Drained Conditions (Effective Stress):

Compute passive resistance throughout the design life of the wall LRFD [Eq 3.11.5.4-1]:

$$r_{ep1} := (k_{pd} \cdot \gamma_{fd} \cdot y_1 + 2 \cdot c'_{fd} \cdot \sqrt{k_{pd}}) \cdot \cos(\delta_{fd}) \qquad \text{Nominal passive pressure at } y_1$$

$$r_{ep2} := (k_{pd} \cdot \gamma_{fd} \cdot y_2 + 2 \cdot c'_{fd} \cdot \sqrt{k_{pd}}) \cdot \cos(\delta_{fd}) \qquad \text{Nominal passive pressure at } y_2$$

$$R_{ep} := \frac{r_{ep1} + r_{ep2}}{2} \cdot (y_2 - y_1) \qquad R_{ep} = 0 \frac{\text{lb}f}{\text{ft}} \qquad \text{Nominal passive resistance Drained Conditions}$$

416 Note: Passive Resistance shall be neglected in stability computations, unless the base of the wall extends below the depth of maximum scour, freeze-thaw or other disturbances. In the latter case, only the embedment below the greater of these depths shall be considered effective LRFD [11.6.3.5].

Compute sliding resistance between soil and foundation:

$$c := 1.0$$

c = 1.0 for Cast-in-Place
c = 0.8 for Precast

$$\Sigma V := V_{Ia} \qquad \Sigma V = 42893.6 \frac{\text{lb}f}{\text{ft}} \qquad \text{Sum of Vertical Loads (Strength Ia)}$$

$$R_\tau := c \cdot \Sigma V \cdot \tan(\phi'_{fd}) \qquad R_\tau = 17330.2 \frac{\text{lb}f}{\text{ft}} \qquad \text{Nominal sliding resistance Cohesionless Soils}$$

Compute factored resistance against failure by sliding LRFD [10.6.3.4]:

$$\phi_{ep} := 0.5$$

Resistance factor for passive resistance specified in LRFD Table 10.5.5.2.2-1

$$\phi_\tau := 1.0$$

Resistance factor for sliding resistance specified in LRFD Table 11.5.7-1.

$$\phi R_n := \phi_\tau \cdot R_\tau + \phi_{ep} \cdot R_{ep}$$

$$R_R := \phi R_n$$

Factored Sliding Resistance to be used in CDR Calculations:

$$R_R = 17330.159 \frac{\text{lb}f}{\text{ft}}$$

Sliding Capacity:Demand Ratio (CDR)

$$CDR_{Sliding} := \frac{R_R}{R_u}$$

Is the CDR > or = to 1.0?

$$CDR_{Sliding} = 1.39$$

Undrained Conditions (Total Stress):

Compute passive resistance throughout the design life of the wall LRFD [Eq 3.11.5.4-1]:

$$r_{ep1} := (k_{pu} \cdot \gamma_{fd} \cdot y_1 + 2 \cdot Su_{fd} \cdot \sqrt{k_{pu}}) \cdot \cos(\delta_{fd})$$

Nominal passive pressure at y1

$$r_{ep2} := (k_{pu} \cdot \gamma_{fd} \cdot y_2 + 2 \cdot Su_{fd} \cdot \sqrt{k_{pu}}) \cdot \cos(\delta_{fd})$$

Nominal passive pressure at y2

$$R_{ep} := \frac{r_{ep1} + r_{ep2}}{2} \cdot (y_2 - y_1) \quad R_{ep} = 0 \frac{lbf}{ft}$$

Nominal passive resistance Drained Conditions

416 Note: Passive Resistance shall be neglected in stability computations, unless the base of the wall extends below the depth of maximum scour, freeze-thaw or other disturbances. In the latter case, only the embedment below the greater of these depths shall be considered effective LRFD [11.6.3.5].

Compute sliding resistance between soil and foundation:

$$c := 1.0$$

c = 1.0 for Cast-in-Place
c = 0.8 for Precast

$$\Sigma V := V_{Ia} \quad \Sigma V = 42893.6 \frac{lbf}{ft}$$

Sum of Vertical Loads (Strength Ia)

$$e = 0.27 \text{ ft}$$

Wall eccentricity, Calculated in above Limiting Eccentricity at Base of Wall (Strength Ia) Section.

$$B = 17 \text{ ft}$$

Footing base width

$$\frac{B}{6} = 2.8 \text{ ft}$$

If e < B/6 the resultant is in the middle one-third

$$\sigma_{vmax} := \frac{\Sigma V}{B} \cdot \left(1 + 6 \cdot \frac{e}{B}\right) \quad \sigma_{vmax} = 2760.8 \frac{lbf}{ft^2}$$

Max vertical stress (if resultant is in the middle one-third of base) LRFD [11.6.3.2-2].

$$\sigma_{vmin} := \frac{\Sigma V}{B} \cdot \left(1 - 6 \cdot \frac{e}{B}\right) \quad \sigma_{vmin} = 2285.5 \frac{lbf}{ft^2}$$

Max vertical stress (if resultant is in the middle one-third of base) LRFD [11.6.3.2-2].

$$q_{max} := \frac{1}{2} \cdot \sigma_{vmax} \quad q_{max} = 1380.4 \frac{lbf}{ft^2}$$

Max unit shear resistance as 1/2 max vertical stress LRFD [10.6.3.4].

$$q_{min} := \frac{1}{2} \cdot \sigma_{vmin} \quad q_{min} = 1142.7 \frac{lbf}{ft^2}$$

Minimum unit shear resistance as 1/2 minimum vertical stress LRFD [10.6.3.4].

Determine which Cohesive Soil Resistance Case is Present:

$$Case_1 := \text{if}(q_{max} > Su_{fd} > q_{min} \geq 0, 1, 0) \quad Case_1 = 0$$

$$Case_2 := \text{if}(Su_{fd} > q_{max} > q_{min} \geq 0, 1, 0) \quad Case_2 = 1$$

$$Case_3 := \text{if}(q_{max} > q_{min} > Su_{fd}, 1, 0) \quad Case_3 = 0$$

$$Case_4 := \text{if}(q_{min} < 0, \text{if}(Su_{fd} < q_{max}, 1, 0), 0) \quad Case_4 = 0$$

$$Case_5 := \text{if}(q_{min} < 0, \text{if}(Su_{fd} > q_{max}, 1, 0), 0) \quad Case_5 = 0$$

Unit Shear Resistance for Case 1:

$$S_1 := Su_{fdu} - q_{min} = 957.3 \frac{\text{lb}}{\text{ft}^2}$$

$$B_1 := \frac{B \cdot (Su_{fdu} - q_{min})}{q_{max} - q_{min}} = 68.5 \text{ ft}$$

$$B_3 := B = 17 \text{ ft}$$

$$I := \frac{1}{2} \cdot S_1 \cdot B_1 = 32771.4 \frac{\text{lb}}{\text{ft}}$$

$$III := S_2 \cdot B_3 = 19426.6 \frac{\text{lb}}{\text{ft}}$$

$$R_{\tau_{case1}} := I + II + III = 2928.6 \frac{\text{lb}}{\text{ft}}$$

$$S_2 := q_{min} = 1142.7 \frac{\text{lb}}{\text{ft}^2}$$

$$B_2 := \frac{B \cdot (q_{max} - Su_{fdu})}{q_{max} - q_{min}} = -51.5 \text{ ft}$$

$$II := S_1 \cdot B_2 = -49269.3 \frac{\text{lb}}{\text{ft}}$$

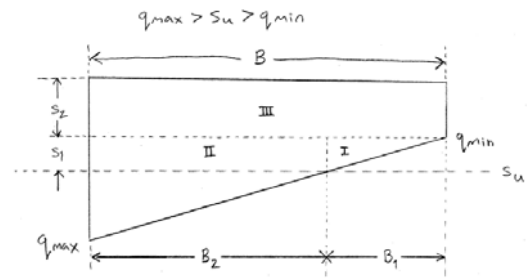

Unit Shear Resistance for Case 2:

$$S_1 := q_{max} - q_{min} = 237.7 \frac{\text{lb}}{\text{ft}^2}$$

$$B = 17 \text{ ft}$$

$$I := \frac{1}{2} \cdot S_1 \cdot B = 2020.2 \frac{\text{lb}}{\text{ft}}$$

$$R_{\tau_{case2}} := I + II = 21446.8 \frac{\text{lb}}{\text{ft}}$$

$$S_2 := q_{min} = 1142.7 \frac{\text{lb}}{\text{ft}^2}$$

$$II := S_2 \cdot B = 19426.6 \frac{\text{lb}}{\text{ft}}$$

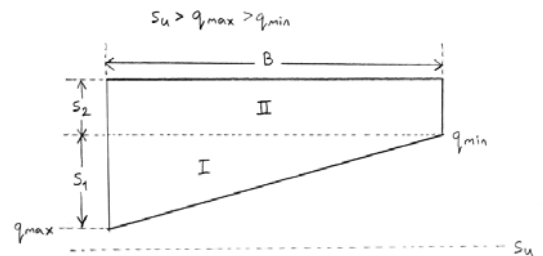

Unit Shear Resistance for Case 3:

$$S_1 := Su_{fdu} = 2100 \frac{\text{lb}}{\text{ft}^2}$$

$$B = 17 \text{ ft}$$

$$I := \frac{1}{2} \cdot S_1 \cdot B = 17850 \frac{\text{lb}}{\text{ft}}$$

$$R_{\tau_{case3}} := I = 17850 \frac{\text{lb}}{\text{ft}}$$

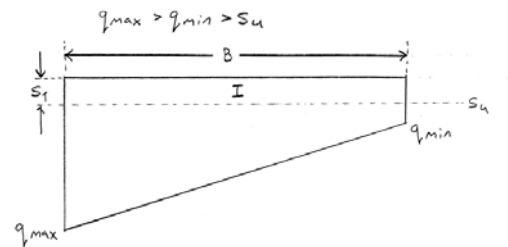

Unit Shear Resistance for Case 4:

$$S_1 := Su_{fdu} = 2100 \frac{\text{lb}}{\text{ft}^2}$$

$$B_3 := \frac{B \cdot (-q_{min})}{q_{max} - q_{min}} = -81.7 \text{ ft}$$

$$B_2 := B - (B_1 + B_3) = -51.5 \text{ ft}$$

$$I := \frac{1}{2} \cdot S_1 \cdot B_1 = 157715.1 \frac{\text{lb}}{\text{ft}}$$

$$R_{\tau_{case4}} := I + II = 49630 \frac{\text{lb}}{\text{ft}}$$

$$B_1 := \left(\frac{Su_{fdu}}{q_{max}} \right) \cdot (B - B_3) = 150.2 \text{ ft}$$

$$II := S_1 \cdot B_2 = -108085.1 \frac{\text{lb}}{\text{ft}}$$

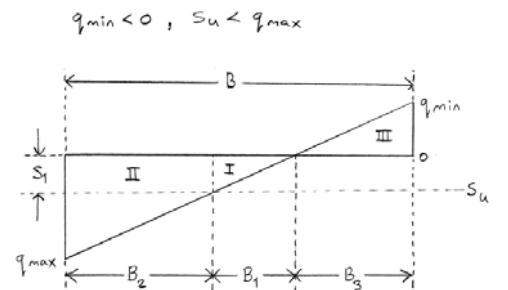

Unit Shear Resistance for Case 5:

$$S_1 := q_{max} = 1380.4 \frac{lbf}{ft^2}$$

$$B_1 := \frac{B \cdot q_{max}}{q_{max} - q_{min}} = 98.7 \text{ ft}$$

$$B_2 := B - B_1 = -81.7 \text{ ft}$$

$$I := \frac{1}{2} \cdot S_1 \cdot B_1 = 68148.2 \frac{lbf}{ft}$$

$$R_{\tau_{case5}} := I = 68148.2 \frac{lbf}{ft}$$

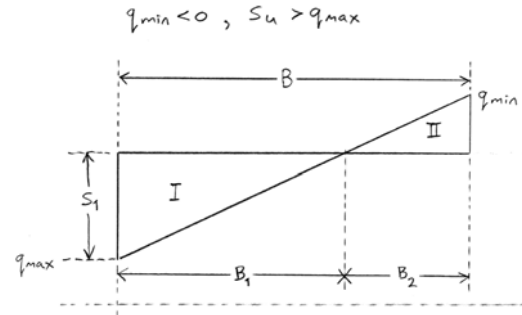

Define the Applicable Case:

$$R_{\tau} := R_{\tau_{case2}}$$

$$R_{\tau} = 21446.8 \frac{lbf}{ft}$$

Nominal sliding resistance Cohesive Soils

Compute factored resistance against failure by sliding **LRFD [10.6.3.4]:**

$$\phi_{ep} := 0.5$$

Resistance factor for passive resistance specified in **LRFD Table 10.5.5.2.2-1**

$$\phi_{\tau} := 1.0$$

Resistance factor for sliding resistance specified in **LRFD Table 11.5.7-1.**

$$\phi R_n := \phi_{\tau} \cdot R_{\tau} + \phi_{ep} \cdot R_{ep}$$

$$R_R := \phi R_n$$

Factored Sliding Resistance to be used in CDR Calculations:

$$R_R = 21446.824 \frac{lbf}{ft}$$

Sliding Capacity: Demand Ratio (CDR)

$$CDR_{Sliding} := \frac{R_R}{R_u}$$

Is the CDR > or = to 1.0?

$$CDR_{Sliding} = 1.72$$

RETAINING WALL 2

Objective: To evaluate the external stability of CIP wall's with level backfill (no backslope).
Method: In accordance with ODOT Bridge Design Manual, 2024 [Sect. 307] LRFD Bridge Design Specifications, 8th Ed., Nov. 2017, [Sect. 11.6.1, Sect. 11.6.2, and Sect. 11.6.3].

Givens:

Backfill Soil Design Parameters:

$$\phi'_f := 30 \text{ deg}$$

Effective angle of internal friction

$$\gamma_f := 120 \frac{\text{lb}}{\text{ft}^3}$$

Unit weight

$$c'_f := 0 \frac{\text{lb}}{\text{ft}^2}$$

Effective Cohesion

$$\delta := 0.67 \cdot \phi'_f$$

$$\delta = 20.1 \text{ deg}$$

Friction angle between backfill and wall taken as specified in **LRFD BDS C3.11.5.3 (degrees)**

Foundation Soil Design Parameters:

Drained Conditions (Effective Stress):

$$\phi'_{fd} := 22 \text{ deg}$$

Effective angle of internal friction

$$\gamma_{fd} := 125 \frac{\text{lb}}{\text{ft}^3}$$

Unit weight

$$c'_{fd} := 205 \frac{\text{lb}}{\text{ft}^2}$$

Effective Cohesion

$$\delta_{fd} := 0.67 \cdot \phi'_{fd}$$

$$\delta_{fd} = 14.7 \text{ deg}$$

Friction angle between foundation soils and footing taken as specified in **LRFD BDS C3.11.5.3 (degrees)**

Undrained Conditions (Total Stress):

$$\phi_{fdu} := 0 \text{ deg}$$

Angle of internal friction (Same as Drained Conditions if granular soils)

$$\gamma_{fd} = 125 \frac{\text{lb}}{\text{ft}^3}$$

Unit weight

$$Su_{fdu} := 2100 \frac{\text{lb}}{\text{ft}^2}$$

Undrained Shear Strength

$$\delta_{fdu} := 0.67 \cdot \phi_{fdu}$$

$$\delta_{fdu} = 0 \text{ deg}$$

Friction angle between foundation soils and footing taken as specified in **LRFD BDS C3.11.5.3 (degrees)**

Foundation Surcharge Soil Parameters:

$$\gamma_q := 120 \frac{\text{lb}}{\text{ft}^3}$$

Unit weight of Soil above bearing depth (Used in Bearing Resistance of Soil Calculation **LRFD 10.6.3.1.2a-1**)

Other Parameters:

$$\gamma_c := 150 \frac{\text{lb}}{\text{ft}^3}$$

Concrete Unit weight

$$\gamma_p := 150 \frac{\text{lb}}{\text{ft}^3}$$

Pavement Unit weight

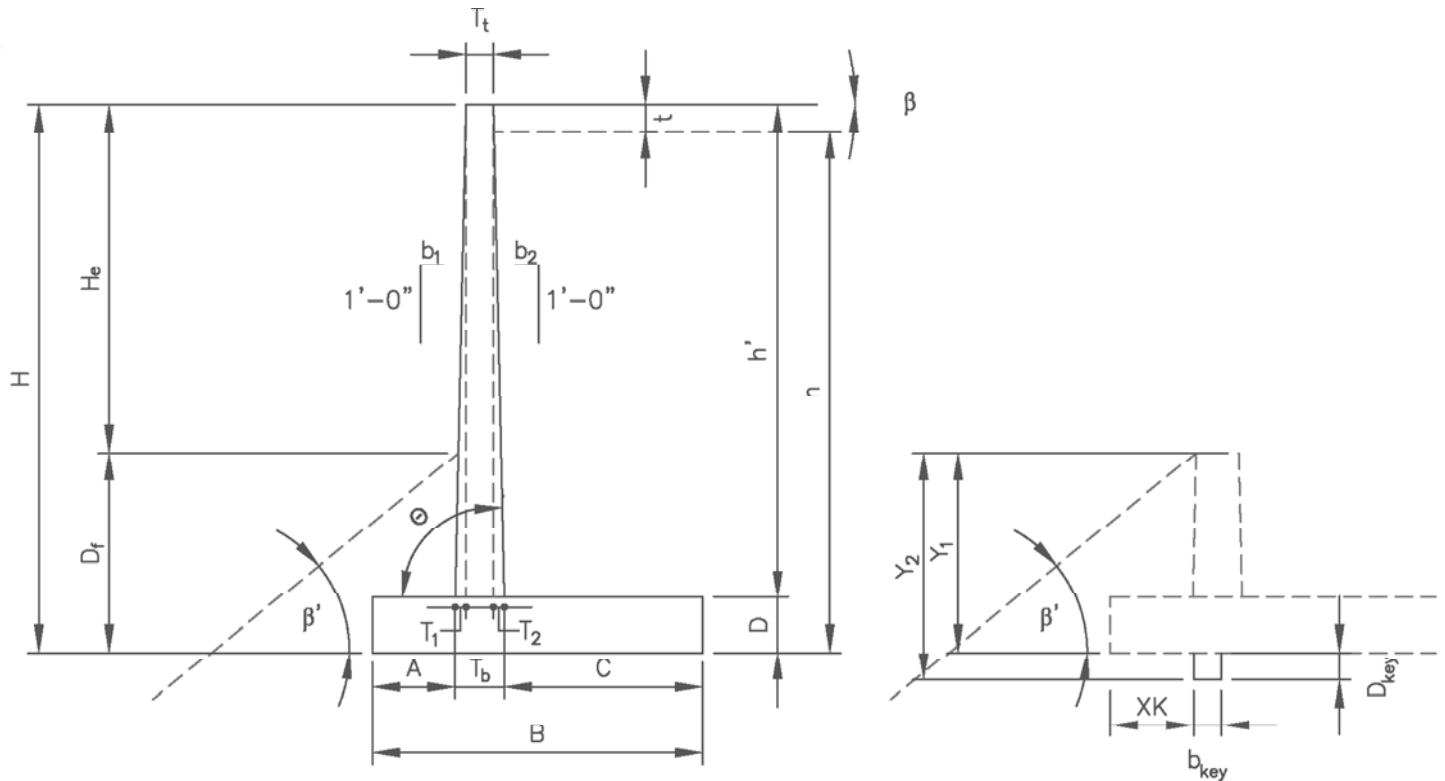

Wall Geometry:

$H_e := 14.27 \text{ ft}$

$D_f := 3.5 \text{ ft}$

$H := H_e + D_f$

$H = 17.8 \text{ ft}$

$T_t := 1.0 \text{ ft}$

$b_1 := 1.52 \cdot \left(\frac{\text{in}}{\text{ft}}\right)$

$b_2 := 0 \cdot \left(\frac{\text{in}}{\text{ft}}\right)$

$\beta := 0 \text{ deg}$

$\beta' := 0 \text{ deg}$

$t := 0.5 \cdot \text{ft}$

- Inclination of ground slope:
- Horizontal: **0**
 - 3H:1V: **18.435**
 - 2H:1V: **26.565**
 - 1.5H:1V: **33.690**

Exposed wall height

Footing cover at Toe

Note: Where the potential for scour, erosion of undermining exists, spread footings shall be located to bear below the maximum depth of scour or undermining. Spread footings shall be located below the depth of potential frost. **LRFD BDS 10.6.1.2.**

Design Wall Height

Stem thickness at top of wall

Frontwall batter, (b1H:12V)

Backwall batter, (b2H:12V)

Inclination of ground slope behind face of wall.
Horizontal backfill behind CIP wall, $\beta = 0 \text{ deg}$

Inclination of ground slope in front of wall. If it is horizontal backfill in front of CIP wall, $\beta' = 0 \text{ deg}$. A negative angle (-) indicates grades slope up from front of wall. Positive angle (+) indicates grade slope down from wall as shown in above figure.

Pavement thickness

Preliminary Wall Dimensioning:

$B := 15 \text{ ft}$	$\frac{2}{5} \cdot H = 7.11 \text{ ft}$ to $\frac{3}{5} \cdot H = 10.66 \text{ ft}$	Footing base width (2/5H to 3/5H)
$A := 1.5 \text{ ft}$	$\frac{H}{8} = 2.22 \text{ ft}$ to $\frac{H}{5} = 3.55 \text{ ft}$	Toe projection (H/8 to H/5)
$D := 2 \text{ ft}$	$\frac{H}{8} = 2.22 \text{ ft}$ to $\frac{H}{5} = 3.55 \text{ ft}$	Footing thickness (H/8 to H/5)

Shear Key Dimensioning:

$D_{key} := 0 \text{ ft}$	Depth of shear key from bottom of footing Note: Footings on rock typically require shear key
$b_{key} := 0 \text{ ft}$	Width of shear key
$XK := A$	Distance from toe to shear key

Other Wall Dimensions:

$h' := H - D$	$h' = 15.8 \text{ ft}$	Stem height
$T_1 := b_1 \cdot h'$	$T_1 = 1.998 \text{ ft}$	Stem front batter width
$T_2 := b_2 \cdot h'$	$T_2 = 0 \text{ ft}$	Stem back batter width
$T_b := T_1 + T_2 + T_t$	$T_b = 2.998 \text{ ft}$	Stem thickness at bottom of wall
$C := B - A - T_b$	$C = 10.502 \text{ ft}$	Heel projection
$\theta := 90 \text{ deg}$		Angle of back face of wall to horizontal = $atan(12/b_2)$
$b := 12 \text{ in}$	$b = 1 \text{ ft}$	Concrete strip width (for design)
$y_1 := 3.5 \cdot \text{ft}$	$y_1 = 3.5 \text{ ft}$	Depth to where passive pressure may begin to be utilized in front of wall. (Typically Df)
$y_2 := D_f + D_{key}$	$y_2 = 3.5 \text{ ft}$	Bottom of shear key/footing depth i.e. depth to where passive pressure may no longer be utilized.
$h := H - t$	$h = 17.3 \text{ ft}$	Height of retained fill at back of heel

Live Load Surcharge Parameters:

$\lambda := 20 \text{ ft}$	Horizontal distance from the back of the wall to point of traffic surcharge load
$SUR := \text{if} \left(\lambda < \frac{H}{2}, 250 \frac{\text{lb}}{\text{ft}^2}, 100 \frac{\text{lb}}{\text{ft}^2} \right) = 100 \frac{\text{lb}}{\text{ft}^2}$	Live load surcharge (per LRFD BDS [3.11.6.4]) Note: If vehicular loading is within 1 ft of the backface of the wall and with a design height, H, less than 20 ft, see LRFD BDS Section 3.11.6.4 and Table 3.11.6.4-2 for adjusted surcharge load calculation. Note: when $\lambda < H/2$, SUR equal 100 psf to account for construction loads

Calculations:

Earth Pressure Coefficients:

Backfill Active Earth:

$$\Gamma := \left(1 + \sqrt{\frac{(\sin(\phi'_f + \delta) \cdot \sin(\phi'_f - \beta))}{(\sin(\theta - \delta) \cdot \sin(\theta + \beta))}} \right)^2 \quad \Gamma = 2.687$$

$$k_{af} := \left(\frac{(\sin(\theta + \phi'_f))^2}{(\Gamma \cdot (\sin(\theta))^2 \cdot \sin(\theta - \delta))} \right) \quad k_{af} = 0.297 \quad \text{Active Earth Pressure Coefficient (per LRFD Sect. 3.11.5.3)}$$

Foundation Soil Passive Earth:

Drained Conditions assuming ($\phi'_{fd} > 0$):

Input Parameters for **LRFD Figure 3.11.5.4-2**, assumes $\theta = 90$ degrees

$$\frac{-\beta'}{\phi'_{fd}} = 0$$

$$\frac{-\delta_{fd}}{\phi'_{fd}} = -0.67$$

$$k'_p := 3.54$$

Passive Earth Pressure Coefficient from **LRFD Figure 3.11.5.4-2**

Determine Reduction Factor (R) by interpolation:

$$R_d := 0.828$$

Reduction Factor

$$k_{pd} := R_d \cdot k'_p$$

$$k_{pd} = 2.931$$

Passive Earth Pressure Coefficient for Drained Conditions

Undrained Conditions ($\phi_{fdu} > 0$): **Note:** Expand window below to complete calculation

Undrained Conditions:

$$k_{pu} := \text{if}(\phi_{fdu} > 0, k_{pu}, 1)$$

$$k_{pu} = 1$$

Passive Earth Pressure Coefficient for Resistance Undrained Conditions

Compute Unfactored Loads LRFD [Tables 3.4.1-1 and 3.4.1-2]:

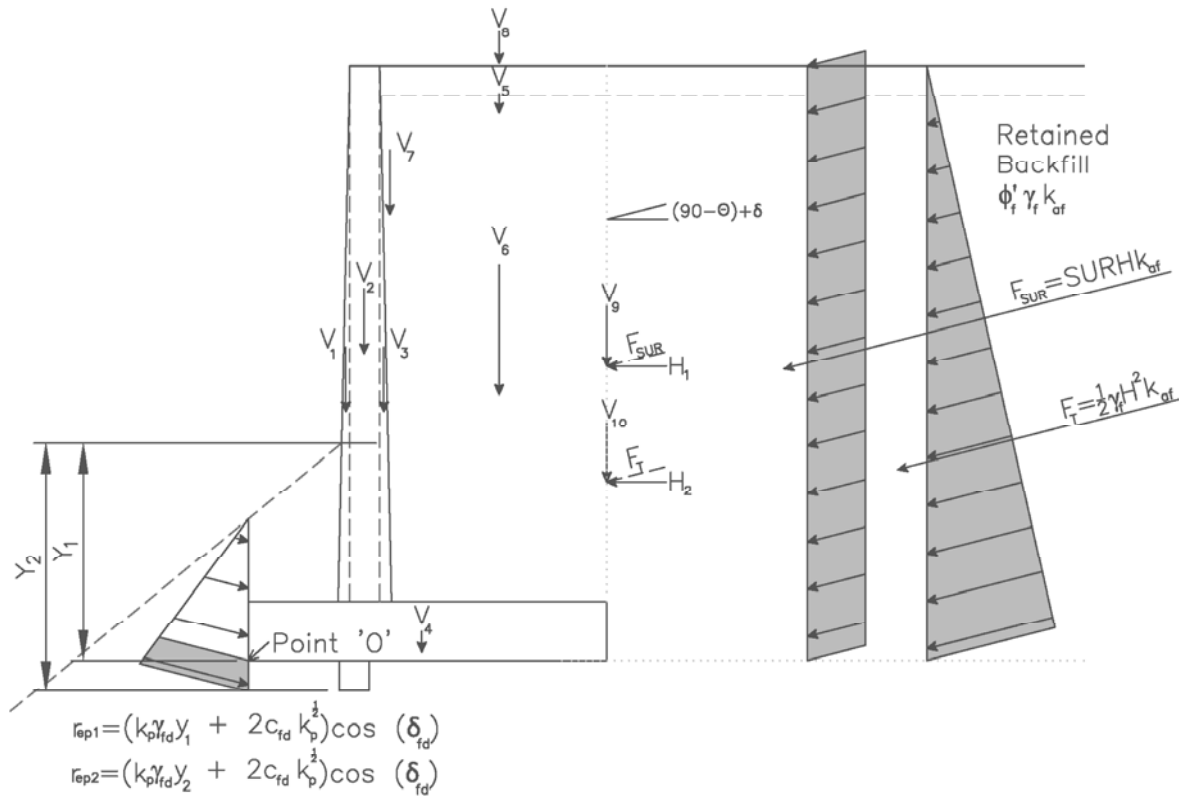

$$F_T := \frac{1}{2} \cdot \gamma_f \cdot H^2 \cdot k_{af}$$

$$F_{SUR} := SUR \cdot H \cdot k_{af}$$

Vertical Loads:

$$V_1 := \frac{1}{2} \cdot T_1 \cdot h' \cdot \gamma_c$$

$$V_2 := T_t \cdot h' \cdot \gamma_c$$

$$V_3 := \frac{1}{2} \cdot T_2 \cdot h' \cdot \gamma_c$$

$$V_4 := D \cdot B \cdot \gamma_c$$

$$V_5 := t \cdot (T_2 + C) \cdot \gamma_p$$

$$V_6 := C \cdot (h' - t) \cdot \gamma_f$$

$$V_7 := \frac{1}{2} \cdot b_2 \cdot (h' - t)^2 \cdot \gamma_f$$

$$V_8 := SUR \cdot (T_2 + C)$$

$$V_9 := F_{SUR} \cdot \sin(90 \cdot \text{deg} - \theta + \delta)$$

$$V_{10} := F_T \cdot \sin(90 \cdot \text{deg} - \theta + \delta)$$

$$F_T = 5632 \frac{\text{lbf}}{\text{ft}}$$

$$F_{SUR} = 528.2 \frac{\text{lbf}}{\text{ft}}$$

$$V_1 = 2362.6 \frac{\text{lbf}}{\text{ft}}$$

$$V_2 = 2365.5 \frac{\text{lbf}}{\text{ft}}$$

$$V_3 = 0 \frac{\text{lbf}}{\text{ft}}$$

$$V_4 = 4500 \frac{\text{lbf}}{\text{ft}}$$

$$V_5 = 787.7 \frac{\text{lbf}}{\text{ft}}$$

$$V_6 = 19244.7 \frac{\text{lbf}}{\text{ft}}$$

$$V_7 = 0 \frac{\text{lbf}}{\text{ft}}$$

$$V_8 = 1050.2 \frac{\text{lbf}}{\text{ft}}$$

$$V_9 = 181.5 \frac{\text{lbf}}{\text{ft}}$$

$$V_{10} = 1935.5 \frac{\text{lbf}}{\text{ft}}$$

Active Earth Force Resultant (EH)

Live Load Surcharge (LS)

Wall stem front batter (DC)

Wall stem (DC)

Wall stem back batter (DC)

Wall Footing (DC)

Pavement (DC)

Soil Backfill - Heel (EV)

Soil Backfill - Batter (EV)

Live Load Surcharge above Heel- (LS)
- Strength lb

Live Load Surcharge Resultant (vertical
comp. - LS) - Strength la

Active earth force resultant (vertical
component - EH)

Moment Arm:

Moments produced from vertical loads about Point 'O'

$$d_{v1} := A + \frac{2}{3} \cdot T_1 = 2.8 \text{ ft}$$

$$d_{v2} := A + T_1 + \frac{T_1}{2} = 4 \text{ ft}$$

$$d_{v3} := A + T_1 + T_1 + \frac{T_2}{3} = 4.5 \text{ ft}$$

$$d_{v4} := \frac{B}{2} = 7.5 \text{ ft}$$

$$d_{v5} := B - \frac{T_2 + C}{2} = 9.7 \text{ ft}$$

$$d_{v6} := B - \frac{C}{2} = 9.7 \text{ ft}$$

$$d_{v7} := A + T_1 + T_1 + \left(\frac{2}{3} \cdot b_2 \cdot (h' - t) \right) = 4.5 \text{ ft}$$

$$d_{v8} := B - \frac{T_2 + C}{2} = 9.7 \text{ ft}$$

$$d_{v9} := B = 15 \text{ ft}$$

$$d_{v10} := B = 15 \text{ ft}$$

Horizontal Loads:

$$H_1 := F_{SUR} \cdot \cos(90 \cdot \text{deg} - \theta + \delta) \quad H_1 = 496.1 \frac{\text{lbf}}{\text{ft}}$$

$$H_2 := F_T \cdot \cos(90 \cdot \text{deg} - \theta + \delta) \quad H_2 = 5289 \frac{\text{lbf}}{\text{ft}}$$

Moment Arm:

$$d_{h1} := \frac{H}{2} \quad d_{h1} = 8.9 \text{ ft}$$

$$d_{h2} := \frac{H}{3} \quad d_{h2} = 5.9 \text{ ft}$$

Unfactored Loads by Load Type:

$$V_{DC} := V_1 + V_2 + V_3 + V_4 + V_5 \quad V_{DC} = 10015.8 \frac{\text{lbf}}{\text{ft}}$$

$$V_{LS_Ia} := V_9 \quad V_{LS_Ia} = 181.5 \frac{\text{lbf}}{\text{ft}}$$

$$V_{EH} := V_{10} \quad V_{EH} = 1935.5 \frac{\text{lbf}}{\text{ft}}$$

$$H_{EH} := H_2 \quad H_{EH} = 5289 \frac{\text{lbf}}{\text{ft}}$$

Moment:

$$MV_1 := V_1 \cdot d_{v1} = 6690.1 \text{ lbf}$$

$$MV_2 := V_2 \cdot d_{v2} = 9456.2 \text{ lbf}$$

$$MV_3 := V_3 \cdot d_{v3} = 0 \text{ lbf}$$

$$MV_4 := V_4 \cdot d_{v4} = 33750 \text{ lbf}$$

$$MV_5 := V_5 \cdot d_{v5} = 7679 \text{ lbf}$$

$$MV_6 := V_6 \cdot d_{v6} = 187612.3 \text{ lbf}$$

$$MV_7 := V_7 \cdot d_{v7} = 0 \text{ lbf}$$

$$MV_8 := V_8 \cdot d_{v8} = 10238.6 \text{ lbf}$$

$$MV_9 := V_9 \cdot d_{v9} = 2723 \text{ lbf}$$

$$MV_{10} := V_{10} \cdot d_{v10} = 29032.4 \text{ lbf}$$

Live Load Surcharge Resultant (horizontal comp. - LS)

Active Earth Force Resultant (horizontal comp. - EH)

Moment:

$$MH_1 := H_1 \cdot d_{h1} \quad MH_1 = 4407.5 \frac{\text{lbf} \cdot \text{ft}}{\text{ft}}$$

$$MH_2 := H_2 \cdot d_{h2} \quad MH_2 = 31328.4 \frac{\text{lbf} \cdot \text{ft}}{\text{ft}}$$

$$V_{EV} := V_6 + V_7 \quad V_{EV} = 19244.7 \frac{\text{lbf}}{\text{ft}}$$

$$V_{LS_Ib} := V_8 + V_9 \quad V_{LS_Ib} = 1231.8 \frac{\text{lbf}}{\text{ft}}$$

$$H_{LS} := H_1 \quad H_{LS} = 496.1 \frac{\text{lbf}}{\text{ft}}$$

Unfactored Moments by Load Type

$M_{DC} := MV_1 + MV_2 + MV_3 + MV_4 + MV_5$	$M_{DC} = 57575.2 \frac{\text{lb} \cdot \text{ft}}{\text{ft}}$
$M_{EV} := MV_6 + MV_7$	$M_{EV} = 187612.3 \frac{\text{lb} \cdot \text{ft}}{\text{ft}}$
$M_{LSV_Ia} := MV_9$	$M_{LSV_Ia} = 2723 \frac{\text{lb} \cdot \text{ft}}{\text{ft}}$
$M_{LSV_Ib} := MV_8 + MV_9$	$M_{LSV_Ib} = 12961.6 \frac{\text{lb} \cdot \text{ft}}{\text{ft}}$
$M_{EH1} := MV_{10}$	$M_{EH1} = 29032.4 \frac{\text{lb} \cdot \text{ft}}{\text{ft}}$
$M_{LSH} := MH_1$	$M_{LSH} = 4407.5 \frac{\text{lb} \cdot \text{ft}}{\text{ft}}$
$M_{EH2} := MH_2$	$M_{EH2} = 31328.4 \frac{\text{lb} \cdot \text{ft}}{\text{ft}}$

Load Combination Limit States:

$\eta := 1$ LRFD Load Modifier
 Strength Limit State I: EV(min) = 1.00 EV(max) = 1.35
 EH(min) = 0.90 EH(max) = 1.50
 LS = 1.75

Strength Limit State Ia: (Sliding and Eccentricity)	$Ia_{DC} := 0.9$	$Ia_{EV} := 1$	$Ia_{EH} := 1.5$	$Ia_{LS} := 1.75$
Strength Limit State Ib: (Bearing Capacity)	$Ib_{DC} := 1.25$	$Ib_{EV} := 1.35$	$Ib_{EH} := 1.5$	$Ib_{LS} := 1.75$

Factored Vertical Loads by Limit State:

$V_{Ia} := \eta \cdot ((Ia_{DC} \cdot V_{DC}) + (Ia_{EV} \cdot V_{EV}) + (Ia_{EH} \cdot V_{EH}) + (Ia_{LS} \cdot V_{LS_Ia}))$	$V_{Ia} = 31479.8 \frac{\text{lb}}{\text{ft}}$
$V_{Ib} := \eta \cdot ((Ib_{DC} \cdot V_{DC}) + (Ib_{EV} \cdot V_{EV}) + (Ib_{EH} \cdot V_{EH}) + (Ib_{LS} \cdot V_{LS_Ib}))$	$V_{Ib} = 43558.9 \frac{\text{lb}}{\text{ft}}$

Factored Horizontal Loads by Limit State:

$H_{Ia} := \eta \cdot ((Ia_{LS} \cdot H_{LS}) + (Ia_{EH} \cdot H_{EH}))$	$H_{Ia} = 8801.6 \frac{\text{lb}}{\text{ft}}$
$H_{Ib} := \eta \cdot ((Ib_{LS} \cdot H_{LS}) + (Ib_{EH} \cdot H_{EH}))$	$H_{Ib} = 8801.6 \frac{\text{lb}}{\text{ft}}$

Factored Moments Produced by Vertical Loads by Limit State:

$MV_{Ia} := \eta \cdot ((Ia_{DC} \cdot M_{DC}) + (Ia_{EV} \cdot M_{EV}) + (Ia_{EH} \cdot M_{EH1}) + (Ia_{LS} \cdot M_{LSV_Ia}))$	$MV_{Ia} = 287743.7 \frac{\text{lb} \cdot \text{ft}}{\text{ft}}$
$MV_{Ib} := \eta \cdot ((Ib_{DC} \cdot M_{DC}) + (Ib_{EV} \cdot M_{EV}) + (Ib_{EH} \cdot M_{EH1}) + (Ib_{LS} \cdot M_{LSV_Ib}))$	$MV_{Ib} = 391476.9 \frac{\text{lb} \cdot \text{ft}}{\text{ft}}$

Factored Moments Produced by Horizontal Loads by Limit State:

$MH_{Ia} := \eta \cdot ((Ia_{LS} \cdot M_{LSH}) + (Ia_{EH} \cdot M_{EH2}))$	$MH_{Ia} = 54705.7 \frac{\text{lb} \cdot \text{ft}}{\text{ft}}$
$MH_{Ib} := \eta \cdot ((Ib_{LS} \cdot M_{LSH}) + (Ib_{EH} \cdot M_{EH2}))$	$MH_{Ib} = 54705.7 \frac{\text{lb} \cdot \text{ft}}{\text{ft}}$

Compute Bearing Resistance:

Compute the resultant location about the toe of the base length (distance from "O") Strength lb:

$\Sigma M_R := MV_{lb}$	$\Sigma M_R = 391476.9 \frac{lb \cdot ft}{ft}$	Sum of Resisting Moments (Strength lb)
$\Sigma M_O := MH_{lb}$	$\Sigma M_O = 54705.7 \frac{lb \cdot ft}{ft}$	Sum of Overturning Moments (Strength lb)
$\Sigma V := V_{lb}$	$\Sigma V = 43558.9 \frac{lb}{ft}$	Sum of Vertical Loads (Strength lb)
$x := \frac{(\Sigma M_R - \Sigma M_O)}{\Sigma V}$	$x = 7.7 \text{ ft}$	Distance from Point "O" the resultant intersects the base

$e := \left \frac{B}{2} - x \right $	$e = 0.23 \text{ ft}$	Wall eccentricity, Note: The vertical stress is assumed to be uniformly distributed over the effective bearing width, B', since the wall is supported by a soil foundation LRFD [11.6.3.2] . The effective bearing width is equal to B-2e. When the foundation eccentricity is negative the absolute value is used.
---------------------------------------	-----------------------	---

Foundation Layout:

$B' := B - 2 \cdot e$	$B' = 14.5 \text{ ft}$	Effective Footing Width
$L' := 38 \text{ ft}$		Effective Footing Length (Assumed)
$H' := H_{lb}$	$H' = 8801.6 \frac{lb}{ft}$	Summation of Horizontal Loads (Strength lb)
$V' := V_{lb}$	$V' = 43558.9 \frac{lb}{ft}$	Summation of Vertical Loads (Strength lb)
$D_f = 3.5 \text{ ft}$		Footing embedment
$d_w := 0 \text{ ft}$		Depth of Groundwater below ground surface at front of wall.

Drained Conditions (Effective Stress):

$N_q := \text{if} \left(\phi'_{fd} > 0, e^{\pi \cdot \tan(\phi'_{fd})} \cdot \tan \left(45 \text{ deg} + \frac{\phi'_{fd}}{2} \right), 1.0 \right)$	$N_q = 7.82$
$N_c := \text{if} \left(\phi'_{fd} > 0, \frac{N_q - 1}{\tan(\phi'_{fd})}, 5.14 \right)$	$N_c = 16.88$
$N_\gamma := 2 \cdot (N_q + 1) \cdot \tan(\phi'_{fd})$	$N_\gamma = 7.1$

Compute shape correction factors per LRFD [Table 10.6.3.1.2a-3]:

$s_c := \text{if} \left(\phi'_{fd} > 0, 1 + \left(\frac{B'}{L'} \right) \cdot \left(\frac{N_q}{N_c} \right), 1 + \left(\frac{B'}{5 \cdot L'} \right) \right)$	$s_c = 1.177$
$s_q := \text{if} \left(\phi'_{fd} > 0, 1 + \left(\frac{B'}{L'} \right) \cdot \tan(\phi'_{fd}), 1 \right)$	$s_q = 1.155$
$s_\gamma := \text{if} \left(\phi'_{fd} > 0, 1 - 0.4 \cdot \left(\frac{B'}{L'} \right), 1 \right)$	$s_\gamma = 0.847$

Load inclination factors:

$$i_q := 1$$

$$i_\gamma := 1$$

$$i_c := 1$$

Assumed to be 1.0, see **LRFD BDS C10.6.3.1.2a**.
"Most geotechnical engineers do not use the load inclination factors". If desired, use LRFD Equations [10.6.3.1.2a-5] thru [10.6.3.1.2a-9].

Compute groundwater depth correction factors per LRFD [Table 10.6.3.1.2a-2]:

$$C_{wq} := \text{if}(d_w \geq D_f, 1.0, 0.5) \quad C_{wq} = 0.5$$

$$C_{wy} := \text{if}(d_w \geq (1.5 \cdot B) + D_f, 1.0, 0.5) \quad C_{wy} = 0.5$$

Depth Correction Factor per Hanson (1970):

$$d_q := \text{if}\left(\frac{D_f}{B} \leq 1, 1 + 2 \cdot \tan(\phi'_{fd}) \cdot (1 - \sin(\phi'_{fd}))^2 \cdot \frac{D_f}{B}, 1 + 2 \cdot \tan(\phi'_{fd}) \cdot (1 - \sin(\phi'_{fd}))^2 \cdot \text{atan}\left(\frac{D_f}{B}\right)\right)$$

$$d_q = 1.07$$

Compute modified bearing capacity factors LRFD [Equation 10.6.3.1.2a-2 to 10.6.3.1.2a-4]:

$$N_{cm} := N_c \cdot s_c \cdot i_c \quad N_{cm} = 19.875$$

$$N_{qm} := N_q \cdot s_q \cdot i_q \quad N_{qm} = 9.03$$

$$N_{\gamma m} := N_\gamma \cdot s_\gamma \cdot i_\gamma \quad N_{\gamma m} = 6.037$$

Compute nominal bearing resistance. LRFD [Eq 10.6.3.1.2a-1]:

$$q_{nd} := c'_{fd} \cdot N_{cm} + \gamma_{fd} \cdot D_f \cdot N_{qm} \cdot d_q \cdot C_{wq} + 0.5 \cdot \gamma_{fd} \cdot B' \cdot N_{\gamma m} \cdot C_{wy} \quad q_{nd} = 8937.9 \frac{\text{lb}}{\text{ft}^2}$$

Compute factored bearing resistance. LRFD [Eq 10.6.3.1.1]:

$$\phi_b := 0.55$$

Bearing resistance factor LRFD Table 11.5.7-1.

$$q_{Rd} := \phi_b \cdot q_{nd} \quad q_{Rd} = 4.9 \text{ ksf}$$

Factored bearing resistance Drained Conditions

Undrained Conditions (Effective Stress):

$$N_q := \text{if}\left(\phi_{fd} > 0, e^{\pi \cdot \tan(\phi_{fd})} \cdot \tan\left(45 \text{ deg} + \frac{\phi_{fd}}{2}\right), 1.0\right) \quad N_q = 1$$

$$N_c := \text{if}\left(\phi_{fd} > 0, \frac{N_q - 1}{\tan(\phi_{fd})}, 5.14\right) \quad N_c = 5.14$$

$$N_\gamma := 2 \cdot (N_q + 1) \cdot \tan(\phi_{fd}) \quad N_\gamma = 0$$

Compute shape correction factors per LRFD [Table 10.6.3.1.2a-3]:

$$s_c := \text{if} \left(\phi_{fd} > 0, 1 + \left(\frac{B'}{L'} \right) \cdot \left(\frac{N_q}{N_c} \right), 1 + \left(\frac{B'}{5 \cdot L'} \right) \right) \quad s_c = 1.077$$

$$s_q := \text{if} \left(\phi_{fd} > 0, 1 + \left(\frac{B'}{L'} \right) \cdot \tan(\phi_{fd}), 1 \right) \quad s_q = 1$$

$$s_\gamma := \text{if} \left(\phi_{fd} > 0, 1 - 0.4 \cdot \left(\frac{B'}{L'} \right), 1 \right) \quad s_\gamma = 1$$

Load inclination factors:

$$i_q := 1$$

$$i_\gamma := 1$$

$$i_c := 1$$

Assumed to be 1.0, see LRFD BDS C10.6.3.1.2a. "Most geotechnical engineers do not use the load inclination factors". If desired, use LRFD Equations [10.6.3.1.2a-5] thru [10.6.3.1.2a-9].

Compute modified bearing capacity factors LRFD [Equation 10.6.3.1.2a-2 to 10.6.3.1.2a-4]:

$$N_{cm} := N_c \cdot s_c \cdot i_c \quad N_{cm} = 5.533$$

$$N_{qm} := N_q \cdot s_q \cdot i_q \quad N_{qm} = 1$$

$$N_{\gamma m} := N_\gamma \cdot s_\gamma \cdot i_\gamma \quad N_{\gamma m} = 0$$

Depth Correction Factor per Hanson (1970):

$$d_q := \text{if} \left(\frac{D_f}{B} \leq 1, 1 + 2 \cdot \tan(\phi_{fd}) \cdot (1 - \sin(\phi_{fd}))^2 \cdot \frac{D_f}{B}, 1 + 2 \cdot \tan(\phi_{fd}) \cdot (1 - \sin(\phi_{fd}))^2 \cdot \text{atan} \left(\frac{D_f}{B} \right) \right)$$

$$d_q = 1$$

Compute nominal bearing resistance. LRFD [Eq 10.6.3.1.2a-1]:

$$q_{nu} := S u_{fd} \cdot N_{cm} + \gamma_{fd} \cdot D_f \cdot N_{qm} \cdot d_q \cdot C_{wq} + 0.5 \cdot \gamma_{fd} \cdot B' \cdot N_{\gamma m} \cdot C_{w\gamma} \quad q_{nu} = 11838.6 \frac{\text{lbf}}{\text{ft}^2}$$

Compute factored bearing resistance. LRFD [Eq 10.6.3.1.1]:

$$\phi_b := .55$$

$$q_{Ru} := \phi_b \cdot q_{nu} \quad q_{Ru} = 6.5 \text{ ksf}$$

Bearing resistance factor LRFD Table 11.5.7-1.

Factored bearing resistance Undrained Conditions

Factored Bearing Resistance Drained vs. Undrained Conditions:

Drained Conditions: $q_{Rd} = 4.9 \text{ ksf}$

Undrained Conditions: $q_{Ru} = 6.5 \text{ ksf}$

Evaluate External Stability of Wall:

Compute the ultimate bearing stress :

$$e = 0.23 \text{ ft}$$

$$\sigma_V := \frac{\Sigma V}{B - 2 \cdot e} \qquad \sigma_V = 2.996 \text{ ksf}$$

Bearing Capacity:Demand Ratio (CDR)

Drained Conditions:	$CDR_{Bearing_D} := \frac{q_{Rd}}{\sigma_V}$	Is the CDR > or = to 1.0?	$CDR_{Bearing_D} = 1.64$
---------------------	---	---------------------------	---------------------------

Undrained Conditions:	$CDR_{Bearing_U} := \frac{q_{Ru}}{\sigma_V}$	Is the CDR > or = to 1.0?	$CDR_{Bearing_U} = 2.17$
-----------------------	---	---------------------------	---------------------------

Limiting Eccentricity at Base of Wall (Strength Ia):

Compute the resultant location about the toe "O" of the base length (distance from Pivot):

$$e_{max} := \frac{B}{3}$$

$$e_{max} = 5 \text{ ft}$$

Maximum Eccentricity **LRFD [11.6.3.3.]**
Equals B/3 for soil.

$$\Sigma M_R := MV_{Ia}$$

$$\Sigma M_R = 287743.7 \frac{\text{lb} \cdot \text{ft}}{\text{ft}}$$

Sum of Resisting Moments (Strength Ia)

$$\Sigma M_O := MH_{Ia}$$

$$\Sigma M_O = 54705.7 \frac{\text{lb} \cdot \text{ft}}{\text{ft}}$$

Sum of Overturning Moments (Strength Ia)

$$\Sigma V := V_{Ia}$$

$$\Sigma V = 31479.8 \frac{\text{lb}}{\text{ft}}$$

Sum of Vertical Loads (Strength Ia)

$$x := \frac{(\Sigma M_R - \Sigma M_O)}{\Sigma V}$$

$$x = 7.4 \text{ ft}$$

Distance from Point "O" the resultant intersects the base

$$e := \text{abs} \left(\frac{B}{2} - x \right)$$

$$e = 0.1 \text{ ft}$$

Wall eccentricity, **Note:** The vertical stress is assumed to be uniformly distributed over the effective bearing width, B', since the wall is supported by a soil foundation **LRFD [11.6.3.2]**. The effective bearing width is equal to B-2e. .

Eccentricity Capacity:Demand Ratio (CDR)

$$CDR_{Eccentricity} := \frac{e_{max}}{e}$$

Is the CDR > or = to 1.0?

$$CDR_{Eccentricity} = 51.43$$

Sliding Resistance at Base of Wall LRFD [10.6.3.4]:

Factored Sliding Force (Strength Ia):

$$R_u := H_{Ia} \qquad R_u = 8801.6 \frac{\text{lb}f}{\text{ft}}$$

Drained Conditions (Effective Stress):

Compute passive resistance throughout the design life of the wall LRFD [Eq 3.11.5.4-1]:

$$r_{ep1} := (k_{pd} \cdot \gamma_{fd} \cdot y_1 + 2 \cdot c'_{fd} \cdot \sqrt{k_{pd}}) \cdot \cos(\delta_{fd}) \qquad \text{Nominal passive pressure at } y_1$$

$$r_{ep2} := (k_{pd} \cdot \gamma_{fd} \cdot y_2 + 2 \cdot c'_{fd} \cdot \sqrt{k_{pd}}) \cdot \cos(\delta_{fd}) \qquad \text{Nominal passive pressure at } y_2$$

$$R_{ep} := \frac{r_{ep1} + r_{ep2}}{2} \cdot (y_2 - y_1) \qquad R_{ep} = 0 \frac{\text{lb}f}{\text{ft}} \qquad \text{Nominal passive resistance Drained Conditions}$$

416 Note: Passive Resistance shall be neglected in stability computations, unless the base of the wall extends below the depth of maximum scour, freeze-thaw or other disturbances. In the latter case, only the embedment below the greater of these depths shall be considered effective LRFD [11.6.3.5].

Compute sliding resistance between soil and foundation:

$$c := 1.0$$

c = 1.0 for Cast-in-Place
c = 0.8 for Precast

$$\Sigma V := V_{Ia} \qquad \Sigma V = 31479.8 \frac{\text{lb}f}{\text{ft}} \qquad \text{Sum of Vertical Loads (Strength Ia)}$$

$$R_\tau := c \cdot \Sigma V \cdot \tan(\phi'_{fd}) \qquad R_\tau = 12718.7 \frac{\text{lb}f}{\text{ft}} \qquad \text{Nominal sliding resistance Cohesionless Soils}$$

Compute factored resistance against failure by sliding LRFD [10.6.3.4]:

$$\phi_{ep} := 0.5$$

Resistance factor for passive resistance specified in LRFD Table 10.5.5.2.2-1

$$\phi_\tau := 1.0$$

Resistance factor for sliding resistance specified in LRFD Table 11.5.7-1.

$$\phi R_n := \phi_\tau \cdot R_\tau + \phi_{ep} \cdot R_{ep}$$

$$R_R := \phi R_n$$

Factored Sliding Resistance to be used in CDR Calculations:

$$R_R = 12718.676 \frac{\text{lb}f}{\text{ft}}$$

Sliding Capacity:Demand Ratio (CDR)

$$CDR_{Sliding} := \frac{R_R}{R_u}$$

Is the CDR > or = to 1.0?

$$CDR_{Sliding} = 1.45$$

Undrained Conditions (Total Stress):

Compute passive resistance throughout the design life of the wall LRFD [Eq 3.11.5.4-1]:

$$r_{ep1} := (k_{pu} \cdot \gamma_{fd} \cdot y_1 + 2 \cdot Su_{fdu} \cdot \sqrt{k_{pu}}) \cdot \cos(\delta_{fd})$$

Nominal passive pressure at y1

$$r_{ep2} := (k_{pu} \cdot \gamma_{fd} \cdot y_2 + 2 \cdot Su_{fdu} \cdot \sqrt{k_{pu}}) \cdot \cos(\delta_{fd})$$

Nominal passive pressure at y2

$$R_{ep} := \frac{r_{ep1} + r_{ep2}}{2} \cdot (y_2 - y_1) \quad R_{ep} = 0 \frac{lbf}{ft}$$

Nominal passive resistance Drained Conditions

416 Note: Passive Resistance shall be neglected in stability computations, unless the base of the wall extends below the depth of maximum scour, freeze-thaw or other disturbances. In the latter case, only the embedment below the greater of these depths shall be considered effective LRFD [11.6.3.5].

Compute sliding resistance between soil and foundation:

$$c := 1.0$$

c = 1.0 for Cast-in-Place
c = 0.8 for Precast

$$\Sigma V := V_{Ia} \quad \Sigma V = 31479.8 \frac{lbf}{ft}$$

Sum of Vertical Loads (Strength Ia)

$$e = 0.1 \text{ ft}$$

Wall eccentricity, Calculated in above Limiting Eccentricity at Base of Wall (Strength Ia) Section.

$$B = 15 \text{ ft}$$

Footing base width

$$\frac{B}{6} = 2.5 \text{ ft}$$

If e < B/6 the resultant is in the middle one-third

$$\sigma_{vmax} := \frac{\Sigma V}{B} \cdot \left(1 + 6 \cdot \frac{e}{B}\right)$$

$$\sigma_{vmax} = 2180.3 \frac{lbf}{ft^2}$$

Max vertical stress (if resultant is in the middle one-third of base) LRFD [11.6.3.2-2].

$$\sigma_{vmin} := \frac{\Sigma V}{B} \cdot \left(1 - 6 \cdot \frac{e}{B}\right)$$

$$\sigma_{vmin} = 2017 \frac{lbf}{ft^2}$$

Max vertical stress (if resultant is in the middle one-third of base) LRFD [11.6.3.2-2].

$$q_{max} := \frac{1}{2} \cdot \sigma_{vmax}$$

$$q_{max} = 1090.1 \frac{lbf}{ft^2}$$

Max unit shear resistance as 1/2 max vertical stress LRFD [10.6.3.4].

$$q_{min} := \frac{1}{2} \cdot \sigma_{vmin}$$

$$q_{min} = 1008.5 \frac{lbf}{ft^2}$$

Minimum unit shear resistance as 1/2 minimum vertical stress LRFD [10.6.3.4].

Determine which Cohesive Soil Resistance Case is Present:

$$Case_1 := \text{if}(q_{max} > Su_{fdu} > q_{min} \geq 0, 1, 0) \quad Case_1 = 0$$

$$Case_2 := \text{if}(Su_{fdu} > q_{max} > q_{min} \geq 0, 1, 0) \quad Case_2 = 1$$

$$Case_3 := \text{if}(q_{max} > q_{min} > Su_{fdu}, 1, 0) \quad Case_3 = 0$$

$$Case_4 := \text{if}(q_{min} < 0, \text{if}(Su_{fdu} < q_{max}, 1, 0), 0) \quad Case_4 = 0$$

$$Case_5 := \text{if}(q_{min} < 0, \text{if}(Su_{fdu} > q_{max}, 1, 0), 0) \quad Case_5 = 0$$

Unit Shear Resistance for Case 1:

$$S_1 := Su_{fdu} - q_{min} = 1091.5 \frac{\text{lb}}{\text{ft}^2}$$

$$B_1 := \frac{B \cdot (Su_{fdu} - q_{min})}{q_{max} - q_{min}} = 200.6 \text{ ft}$$

$$B_3 := B = 15 \text{ ft}$$

$$I := \frac{1}{2} \cdot S_1 \cdot B_1 = 109474.7 \frac{\text{lb}}{\text{ft}}$$

$$III := S_2 \cdot B_3 = 15127.8 \frac{\text{lb}}{\text{ft}}$$

$$R_{\tau_{case1}} := I + II + III = -77974.7 \frac{\text{lb}}{\text{ft}}$$

$$S_2 := q_{min} = 1008.5 \frac{\text{lb}}{\text{ft}^2}$$

$$B_2 := \frac{B \cdot (q_{max} - Su_{fdu})}{q_{max} - q_{min}} = -185.6 \text{ ft}$$

$$II := S_1 \cdot B_2 = -202577.1 \frac{\text{lb}}{\text{ft}}$$

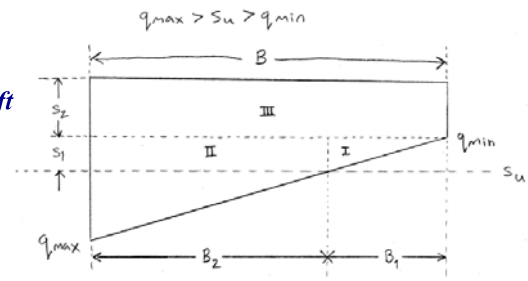

Unit Shear Resistance for Case 2:

$$S_1 := q_{max} - q_{min} = 81.6 \frac{\text{lb}}{\text{ft}^2}$$

$$B = 15 \text{ ft}$$

$$I := \frac{1}{2} \cdot S_1 \cdot B = 612.1 \frac{\text{lb}}{\text{ft}}$$

$$R_{\tau_{case2}} := I + II = 15739.9 \frac{\text{lb}}{\text{ft}}$$

$$S_2 := q_{min} = 1008.5 \frac{\text{lb}}{\text{ft}^2}$$

$$II := S_2 \cdot B = 15127.8 \frac{\text{lb}}{\text{ft}}$$

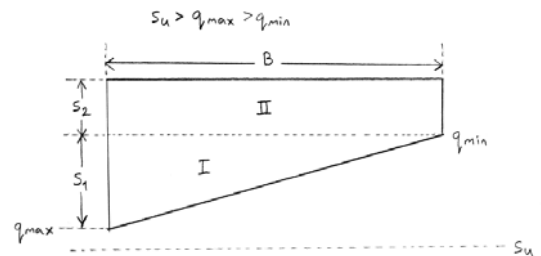

Unit Shear Resistance for Case 3:

$$S_1 := Su_{fdu} = 2100 \frac{\text{lb}}{\text{ft}^2}$$

$$B = 15 \text{ ft}$$

$$I := \frac{1}{2} \cdot S_1 \cdot B = 15750 \frac{\text{lb}}{\text{ft}}$$

$$R_{\tau_{case3}} := I = 15750 \frac{\text{lb}}{\text{ft}}$$

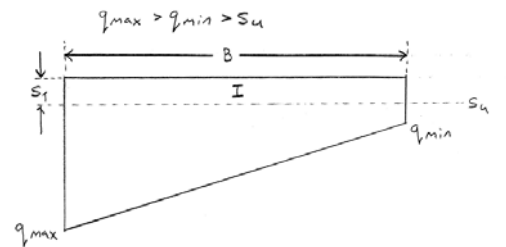

Unit Shear Resistance for Case 4:

$$S_1 := Su_{fdu} = 2100 \frac{\text{lb}}{\text{ft}^2}$$

$$B_3 := \frac{B \cdot (-q_{min})}{q_{max} - q_{min}} = -185.4 \text{ ft}$$

$$B_2 := B - (B_1 + B_3) = -185.6 \text{ ft}$$

$$I := \frac{1}{2} \cdot S_1 \cdot B_1 = 405247.2 \frac{\text{lb}}{\text{ft}}$$

$$R_{\tau_{case4}} := I + II = 15490.5 \frac{\text{lb}}{\text{ft}}$$

$$B_1 := \left(\frac{Su_{fdu}}{q_{max}} \right) \cdot (B - B_3) = 385.9 \text{ ft}$$

$$II := S_1 \cdot B_2 = -389756.7 \frac{\text{lb}}{\text{ft}}$$

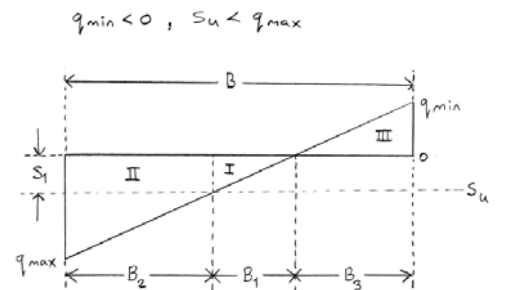

Unit Shear Resistance for Case 5:

$$S_1 := q_{max} = 1090.1 \frac{lb}{ft^2}$$

$$B_1 := \frac{B \cdot q_{max}}{q_{max} - q_{min}} = 200.4 \text{ ft}$$

$$B_2 := B - B_1 = -185.4 \text{ ft}$$

$$I := \frac{1}{2} \cdot S_1 \cdot B_1 = 109205.1 \frac{lb}{ft}$$

$$R_{\tau_{case5}} := I = 109205.1 \frac{lb}{ft}$$

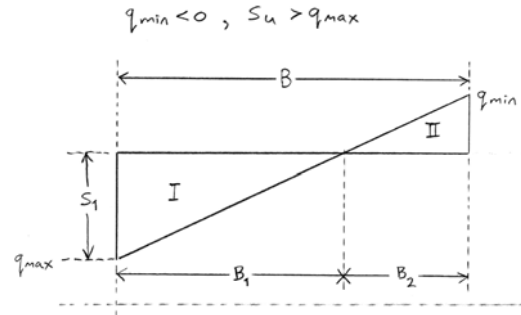

Define the Applicable Case:

$$R_{\tau} := R_{\tau_{case2}}$$

$$R_{\tau} = 15739.9 \frac{lb}{ft}$$

Nominal sliding resistance Cohesive Soils

Compute factored resistance against failure by sliding **LRFD [10.6.3.4]:**

$$\phi_{ep} := 0.5$$

Resistance factor for passive resistance specified in **LRFD Table 10.5.5.2.2-1**

$$\phi_{\tau} := 1.0$$

Resistance factor for sliding resistance specified in **LRFD Table 11.5.7-1.**

$$\phi R_n := \phi_{\tau} \cdot R_{\tau} + \phi_{ep} \cdot R_{ep}$$

$$R_R := \phi R_n$$

Factored Sliding Resistance to be used in CDR Calculations:

$$R_R = 15739.914 \frac{lb}{ft}$$

Sliding Capacity: Demand Ratio (CDR)

$$CDR_{Sliding} := \frac{R_R}{R_u}$$

Is the CDR > or = to 1.0?

$$CDR_{Sliding} = 1.79$$

RETAINING WALL 3

Objective: To evaluate the external stability of CIP wall's with level backfill (no backslope).
Method: In accordance with ODOT Bridge Design Manual, 2024 [Sect. 307] LRFD Bridge Design Specifications, 8th Ed., Nov. 2017, [Sect. 11.6.1, Sect. 11.6.2, and Sect. 11.6.3].

Givens:

Backfill Soil Design Parameters:

$$\phi'_f := 30 \text{ deg}$$

Effective angle of internal friction

$$\gamma_f := 120 \frac{\text{lb}}{\text{ft}^3}$$

Unit weight

$$c'_f := 0 \frac{\text{lb}}{\text{ft}^2}$$

Effective Cohesion

$$\delta := 0.67 \cdot \phi'_f$$

$$\delta = 20.1 \text{ deg}$$

Friction angle between backfill and wall taken as specified in **LRFD BDS C3.11.5.3 (degrees)**

Foundation Soil Design Parameters:

Drained Conditions (Effective Stress):

$$\phi'_{fd} := 22 \text{ deg}$$

Effective angle of internal friction

$$\gamma_{fd} := 125 \frac{\text{lb}}{\text{ft}^3}$$

Unit weight

$$c'_{fd} := 205 \frac{\text{lb}}{\text{ft}^2}$$

Effective Cohesion

$$\delta_{fd} := 0.67 \cdot \phi'_{fd}$$

$$\delta_{fd} = 14.7 \text{ deg}$$

Friction angle between foundation soils and footing taken as specified in **LRFD BDS C3.11.5.3 (degrees)**

Undrained Conditions (Total Stress):

$$\phi_{fdu} := 0 \text{ deg}$$

Angle of internal friction (Same as Drained Conditions if granular soils)

$$\gamma_{fd} = 125 \frac{\text{lb}}{\text{ft}^3}$$

Unit weight

$$Su_{fdu} := 2100 \frac{\text{lb}}{\text{ft}^2}$$

Undrained Shear Strength

$$\delta_{fdu} := 0.67 \cdot \phi_{fdu}$$

$$\delta_{fdu} = 0 \text{ deg}$$

Friction angle between foundation soils and footing taken as specified in **LRFD BDS C3.11.5.3 (degrees)**

Foundation Surcharge Soil Parameters:

$$\gamma_q := 120 \frac{\text{lb}}{\text{ft}^3}$$

Unit weight of Soil above bearing depth (Used in Bearing Resistance of Soil Calculation **LRFD 10.6.3.1.2a-1**)

Other Parameters:

$$\gamma_c := 150 \frac{\text{lb}}{\text{ft}^3}$$

Concrete Unit weight

$$\gamma_p := 150 \frac{\text{lb}}{\text{ft}^3}$$

Pavement Unit weight

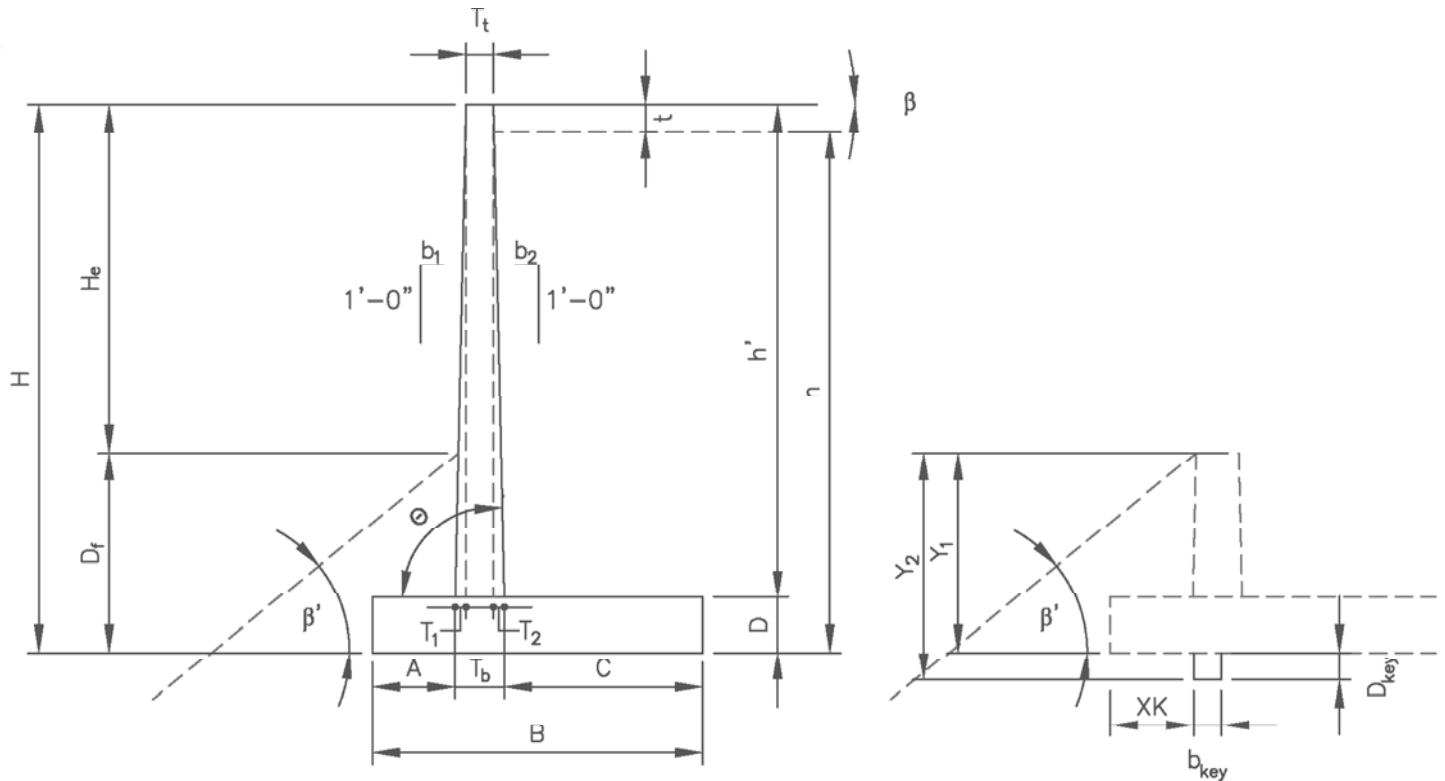

Wall Geometry:

$H_e := 14.27 \text{ ft}$

$D_f := 3.5 \text{ ft}$

$H := H_e + D_f$

$H = 17.8 \text{ ft}$

$T_t := 2 \text{ ft}$

$b_1 := 0 \cdot \left(\frac{\text{in}}{\text{ft}}\right)$

$b_2 := 0 \cdot \left(\frac{\text{in}}{\text{ft}}\right)$

$\beta := 0 \text{ deg}$

$\beta' := 0 \text{ deg}$

$t := 0.5 \cdot \text{ft}$

- Inclination of ground slope:
- Horizontal: **0**
 - 3H:1V: **18.435**
 - 2H:1V: **26.565**
 - 1.5H:1V: **33.690**

Exposed wall height

Footing cover at Toe

Note: Where the potential for scour, erosion of undermining exists, spread footings shall be located to bear below the maximum depth of scour or undermining. Spread footings shall be located below the depth of potential frost. **LRFD BDS 10.6.1.2.**

Design Wall Height

Stem thickness at top of wall

Frontwall batter, (b1H:12V)

Backwall batter, (b2H:12V)

Inclination of ground slope behind face of wall.
Horizontal backfill behind CIP wall, $\beta = 0 \text{ deg}$

Inclination of ground slope in front of wall. If it is horizontal backfill in front of CIP wall, $\beta' = 0 \text{ deg}$. A negative angle (-) indicates grades slope up from front of wall. Positive angle (+) indicates grade slope down from wall as shown in above figure.

Pavement thickness

Preliminary Wall Dimensioning:

$B := 13 \text{ ft}$ $\frac{2}{5} \cdot H = 7.11 \text{ ft}$ to $\frac{3}{5} \cdot H = 10.66 \text{ ft}$ Footing base width (2/5H to 3/5H)

$A := 1.5 \text{ ft}$ $\frac{H}{8} = 2.22 \text{ ft}$ to $\frac{H}{5} = 3.55 \text{ ft}$ Toe projection (H/8 to H/5)

$D := 2 \text{ ft}$ $\frac{H}{8} = 2.22 \text{ ft}$ to $\frac{H}{5} = 3.55 \text{ ft}$ Footing thickness (H/8 to H/5)

Shear Key Dimensioning:

$D_{key} := 0 \text{ ft}$ Depth of shear key from bottom of footing
Note: Footings on rock typically require shear key

$b_{key} := 0 \text{ ft}$ Width of shear key

$XK := A$ Distance from toe to shear key

Other Wall Dimensions:

$h' := H - D$ $h' = 15.8 \text{ ft}$ Stem height

$T_1 := b_1 \cdot h'$ $T_1 = 0 \text{ ft}$ Stem front batter width

$T_2 := b_2 \cdot h'$ $T_2 = 0 \text{ ft}$ Stem back batter width

$T_b := T_1 + T_2 + T_t$ $T_b = 2 \text{ ft}$ Stem thickness at bottom of wall

$C := B - A - T_b$ $C = 9.5 \text{ ft}$ Heel projection

$\theta := 90 \text{ deg}$ Angle of back face of wall to horizontal = $\text{atan}(12/b_2)$

$b := 12 \text{ in}$ $b = 1 \text{ ft}$ Concrete strip width (for design)

$y_1 := 3.5 \cdot \text{ft}$ $y_1 = 3.5 \text{ ft}$ Depth to where passive pressure may begin to be utilized in front of wall. (Typically Df)

$y_2 := D_f + D_{key}$ $y_2 = 3.5 \text{ ft}$ Bottom of shear key/footing depth i.e. depth to where passive pressure may no longer be utilized.

$h := H - t$ $h = 17.3 \text{ ft}$ Height of retained fill at back of heel

Live Load Surcharge Parameters:

$\lambda := 20 \text{ ft}$ Horizontal distance from the back of the wall to point of traffic surcharge load

$SUR := \text{if} \left(\lambda < \frac{H}{2}, 250 \frac{\text{lb}}{\text{ft}^2}, 100 \frac{\text{lb}}{\text{ft}^2} \right) = 100 \frac{\text{lb}}{\text{ft}^2}$ Live load surcharge (per LRFD BDS [3.11.6.4])
Note: If vehicular loading is within 1 ft of the backface of the wall and with a design height, H, less than 20 ft, see LRFD BDS Section 3.11.6.4 and Table 3.11.6.4-2 for adjusted surcharge load calculation.
Note: when $\lambda < H/2$, SUR equal 100 psf to account for construction loads

Calculations:

Earth Pressure Coefficients:

Backfill Active Earth:

$$\Gamma := \left(1 + \sqrt{\frac{(\sin(\phi'_f + \delta) \cdot \sin(\phi'_f - \beta))^2}{(\sin(\theta - \delta) \cdot \sin(\theta + \beta))}} \right) \quad \Gamma = 2.687$$

$$k_{af} := \left(\frac{(\sin(\theta + \phi'_f))^2}{(\Gamma \cdot (\sin(\theta))^2 \cdot \sin(\theta - \delta))} \right) \quad k_{af} = 0.297 \quad \text{Active Earth Pressure Coefficient (per LRFD Sect. 3.11.5.3)}$$

Foundation Soil Passive Earth:

Drained Conditions assuming ($\phi'_{fd} > 0$):

Input Parameters for **LRFD Figure 3.11.5.4-2**, assumes $\theta = 90$ degrees

$$\frac{-\beta'}{\phi'_{fd}} = 0$$

$$\frac{-\delta_{fd}}{\phi'_{fd}} = -0.67$$

$$k'_p := 3.54$$

Passive Earth Pressure Coefficient from **LRFD Figure 3.11.5.4-2**

Determine Reduction Factor (R) by interpolation:

$$R_d := 0.828$$

Reduction Factor

$$k_{pd} := R_d \cdot k'_p$$

$$k_{pd} = 2.931$$

Passive Earth Pressure Coefficient for Drained Conditions

Undrained Conditions ($\phi_{fdu} > 0$): **Note:** Expand window below to complete calculation

Undrained Conditions:

$$k_{pu} := \text{if}(\phi_{fdu} > 0, k_{pu}, 1)$$

$$k_{pu} = 1$$

Passive Earth Pressure Coefficient for Resistance Undrained Conditions

Compute Unfactored Loads LRFD [Tables 3.4.1-1 and 3.4.1-2]:

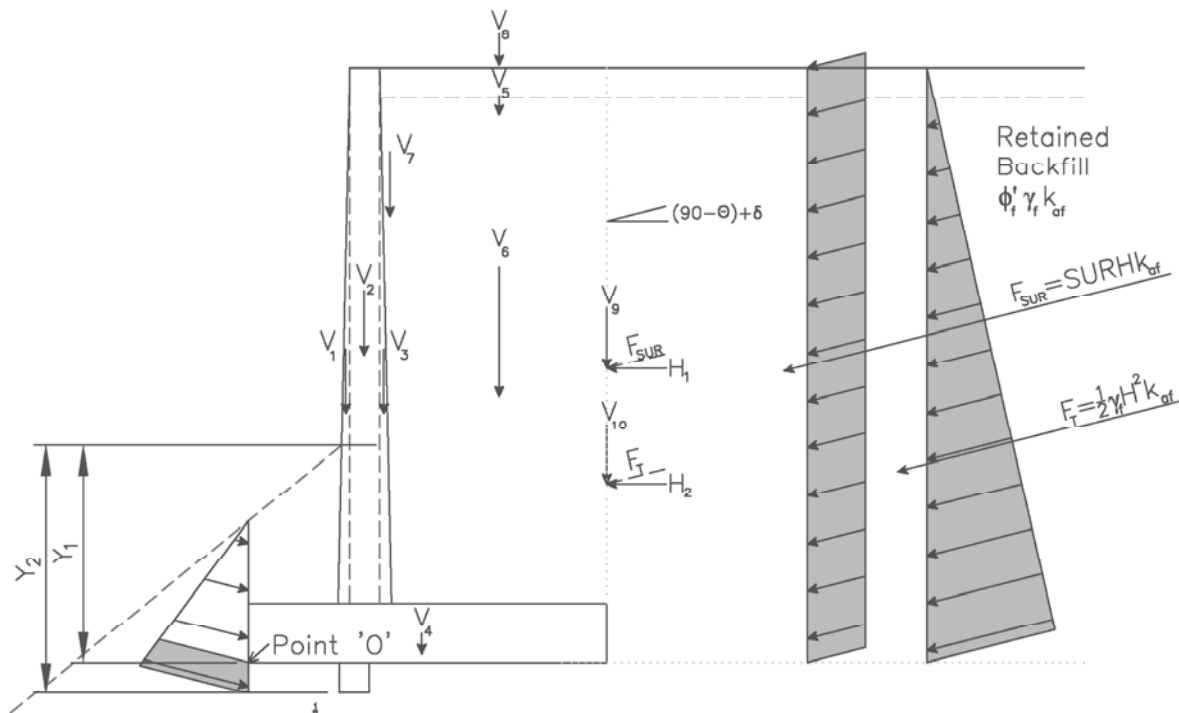

$$r_{ep1} = (k_p \gamma_{fd} y_1 + 2c_{fd} k_p^{\frac{1}{2}}) \cos(\delta_{fd})$$

$$r_{ep2} = (k_p \gamma_{fd} y_2 + 2c_{fd} k_p^{\frac{1}{2}}) \cos(\delta_{fd})$$

$$F_T := \frac{1}{2} \cdot \gamma_f \cdot H^2 \cdot k_{af}$$

$$F_{SUR} := SUR \cdot H \cdot k_{af}$$

Vertical Loads:

$$V_1 := \frac{1}{2} \cdot T_1 \cdot h' \cdot \gamma_c$$

$$V_2 := T_t \cdot h' \cdot \gamma_c$$

$$V_3 := \frac{1}{2} \cdot T_2 \cdot h' \cdot \gamma_c$$

$$V_4 := D \cdot B \cdot \gamma_c$$

$$V_5 := t \cdot (T_2 + C) \cdot \gamma_p$$

$$V_6 := C \cdot (h' - t) \cdot \gamma_f$$

$$V_7 := \frac{1}{2} \cdot b_2 \cdot (h' - t)^2 \cdot \gamma_f$$

$$V_8 := SUR \cdot (T_2 + C)$$

$$V_9 := F_{SUR} \cdot \sin(90 \cdot \text{deg} - \theta + \delta)$$

$$V_{10} := F_T \cdot \sin(90 \cdot \text{deg} - \theta + \delta)$$

$$F_T = 5632 \frac{\text{lb}}{\text{ft}}$$

$$F_{SUR} = 528.2 \frac{\text{lb}}{\text{ft}}$$

$$V_1 = 0 \frac{\text{lb}}{\text{ft}}$$

$$V_2 = 4731 \frac{\text{lb}}{\text{ft}}$$

$$V_3 = 0 \frac{\text{lb}}{\text{ft}}$$

$$V_4 = 3900 \frac{\text{lb}}{\text{ft}}$$

$$V_5 = 712.5 \frac{\text{lb}}{\text{ft}}$$

$$V_6 = 17407.8 \frac{\text{lb}}{\text{ft}}$$

$$V_7 = 0 \frac{\text{lb}}{\text{ft}}$$

$$V_8 = 950 \frac{\text{lb}}{\text{ft}}$$

$$V_9 = 181.5 \frac{\text{lb}}{\text{ft}}$$

$$V_{10} = 1935.5 \frac{\text{lb}}{\text{ft}}$$

Active Earth Force Resultant (EH)

Live Load Surcharge (LS)

Wall stem front batter (DC)

Wall stem (DC)

Wall stem back batter (DC)

Wall Footing (DC)

Pavement (DC)

Soil Backfill - Heel (EV)

Soil Backfill - Batter (EV)

Live Load Surcharge above Heel- (LS)
- Strength lb

Live Load Surcharge Resultant (vertical
comp. - LS) - Strength la

Active earth force resultant (vertical
component - EH)

Moment Arm:

Moments produced from vertical loads about Point 'O'

$$d_{v1} := A + \frac{2}{3} \cdot T_1 = 1.5 \text{ ft}$$

$$d_{v2} := A + T_1 + \frac{T_1}{2} = 2.5 \text{ ft}$$

$$d_{v3} := A + T_1 + T_1 + \frac{T_2}{3} = 3.5 \text{ ft}$$

$$d_{v4} := \frac{B}{2} = 6.5 \text{ ft}$$

$$d_{v5} := B - \frac{T_2 + C}{2} = 8.3 \text{ ft}$$

$$d_{v6} := B - \frac{C}{2} = 8.3 \text{ ft}$$

$$d_{v7} := A + T_1 + T_1 + \left(\frac{2}{3} \cdot b_2 \cdot (h' - t) \right) = 3.5 \text{ ft}$$

$$d_{v8} := B - \frac{T_2 + C}{2} = 8.3 \text{ ft}$$

$$d_{v9} := B = 13 \text{ ft}$$

$$d_{v10} := B = 13 \text{ ft}$$

Moment:

$$MV_1 := V_1 \cdot d_{v1} = 0 \text{ lbf}$$

$$MV_2 := V_2 \cdot d_{v2} = 11827.5 \text{ lbf}$$

$$MV_3 := V_3 \cdot d_{v3} = 0 \text{ lbf}$$

$$MV_4 := V_4 \cdot d_{v4} = 25350 \text{ lbf}$$

$$MV_5 := V_5 \cdot d_{v5} = 5878.1 \text{ lbf}$$

$$MV_6 := V_6 \cdot d_{v6} = 143614.4 \text{ lbf}$$

$$MV_7 := V_7 \cdot d_{v7} = 0 \text{ lbf}$$

$$MV_8 := V_8 \cdot d_{v8} = 7837.5 \text{ lbf}$$

$$MV_9 := V_9 \cdot d_{v9} = 2359.9 \text{ lbf}$$

$$MV_{10} := V_{10} \cdot d_{v10} = 25161.4 \text{ lbf}$$

Horizontal Loads:

$$H_1 := F_{SUR} \cdot \cos(90 \cdot \text{deg} - \theta + \delta) \quad H_1 = 496.1 \frac{\text{lbf}}{\text{ft}}$$

$$H_2 := F_T \cdot \cos(90 \cdot \text{deg} - \theta + \delta) \quad H_2 = 5289 \frac{\text{lbf}}{\text{ft}}$$

Live Load Surcharge Resultant (horizontal comp. - LS)

Active Earth Force Resultant (horizontal comp. - EH)

Moment Arm:

$$d_{h1} := \frac{H}{2} \quad d_{h1} = 8.9 \text{ ft}$$

$$d_{h2} := \frac{H}{3} \quad d_{h2} = 5.9 \text{ ft}$$

Moment:

$$MH_1 := H_1 \cdot d_{h1} \quad MH_1 = 4407.5 \frac{\text{lbf} \cdot \text{ft}}{\text{ft}}$$

$$MH_2 := H_2 \cdot d_{h2} \quad MH_2 = 31328.4 \frac{\text{lbf} \cdot \text{ft}}{\text{ft}}$$

Unfactored Loads by Load Type:

$$V_{DC} := V_1 + V_2 + V_3 + V_4 + V_5 \quad V_{DC} = 9343.5 \frac{\text{lbf}}{\text{ft}}$$

$$V_{EV} := V_6 + V_7 \quad V_{EV} = 17407.8 \frac{\text{lbf}}{\text{ft}}$$

$$V_{LS_Ia} := V_9 \quad V_{LS_Ia} = 181.5 \frac{\text{lbf}}{\text{ft}}$$

$$V_{LS_Ib} := V_8 + V_9 \quad V_{LS_Ib} = 1131.5 \frac{\text{lbf}}{\text{ft}}$$

$$V_{EH} := V_{10} \quad V_{EH} = 1935.5 \frac{\text{lbf}}{\text{ft}}$$

$$H_{LS} := H_1 \quad H_{LS} = 496.1 \frac{\text{lbf}}{\text{ft}}$$

$$H_{EH} := H_2 \quad H_{EH} = 5289 \frac{\text{lbf}}{\text{ft}}$$

Unfactored Moments by Load Type

$M_{DC} := MV_1 + MV_2 + MV_3 + MV_4 + MV_5$	$M_{DC} = 43055.6 \frac{\text{lb}\cdot\text{ft}}{\text{ft}}$
$M_{EV} := MV_6 + MV_7$	$M_{EV} = 143614.4 \frac{\text{lb}\cdot\text{ft}}{\text{ft}}$
$M_{LSV_Ia} := MV_9$	$M_{LSV_Ia} = 2359.9 \frac{\text{lb}\cdot\text{ft}}{\text{ft}}$
$M_{LSV_Ib} := MV_8 + MV_9$	$M_{LSV_Ib} = 10197.4 \frac{\text{lb}\cdot\text{ft}}{\text{ft}}$
$M_{EH1} := MV_{10}$	$M_{EH1} = 25161.4 \frac{\text{lb}\cdot\text{ft}}{\text{ft}}$
$M_{LSH} := MH_1$	$M_{LSH} = 4407.5 \frac{\text{lb}\cdot\text{ft}}{\text{ft}}$
$M_{EH2} := MH_2$	$M_{EH2} = 31328.4 \frac{\text{lb}\cdot\text{ft}}{\text{ft}}$

Load Combination Limit States:

$\eta := 1$ LRFD Load Modifier

Strength Limit State I: EV(min) = 1.00 EV(max) = 1.35
EH(min) = 0.90 EH(max) = 1.50
LS = 1.75

Strength Limit State Ia: (Sliding and Eccentricity)	$Ia_{DC} := 0.9$	$Ia_{EV} := 1$	$Ia_{EH} := 1.5$	$Ia_{LS} := 1.75$
Strength Limit State Ib: (Bearing Capacity)	$Ib_{DC} := 1.25$	$Ib_{EV} := 1.35$	$Ib_{EH} := 1.5$	$Ib_{LS} := 1.75$

Factored Vertical Loads by Limit State:

$V_{Ia} := \eta \cdot ((Ia_{DC} \cdot V_{DC}) + (Ia_{EV} \cdot V_{EV}) + (Ia_{EH} \cdot V_{EH}) + (Ia_{LS} \cdot V_{LS_Ia}))$	$V_{Ia} = 29037.9 \frac{\text{lb}}{\text{ft}}$
$V_{Ib} := \eta \cdot ((Ib_{DC} \cdot V_{DC}) + (Ib_{EV} \cdot V_{EV}) + (Ib_{EH} \cdot V_{EH}) + (Ib_{LS} \cdot V_{LS_Ib}))$	$V_{Ib} = 40063.3 \frac{\text{lb}}{\text{ft}}$

Factored Horizontal Loads by Limit State:

$H_{Ia} := \eta \cdot ((Ia_{LS} \cdot H_{LS}) + (Ia_{EH} \cdot H_{EH}))$	$H_{Ia} = 8801.6 \frac{\text{lb}}{\text{ft}}$
$H_{Ib} := \eta \cdot ((Ib_{LS} \cdot H_{LS}) + (Ib_{EH} \cdot H_{EH}))$	$H_{Ib} = 8801.6 \frac{\text{lb}}{\text{ft}}$

Factored Moments Produced by Vertical Loads by Limit State:

$MV_{Ia} := \eta \cdot ((Ia_{DC} \cdot M_{DC}) + (Ia_{EV} \cdot M_{EV}) + (Ia_{EH} \cdot M_{EH1}) + (Ia_{LS} \cdot M_{LSV_Ia}))$	$MV_{Ia} = 224236.3 \frac{\text{lb}\cdot\text{ft}}{\text{ft}}$
$MV_{Ib} := \eta \cdot ((Ib_{DC} \cdot M_{DC}) + (Ib_{EV} \cdot M_{EV}) + (Ib_{EH} \cdot M_{EH1}) + (Ib_{LS} \cdot M_{LSV_Ib}))$	$MV_{Ib} = 303286.5 \frac{\text{lb}\cdot\text{ft}}{\text{ft}}$

Factored Moments Produced by Horizontal Loads by Limit State:

$MH_{Ia} := \eta \cdot ((Ia_{LS} \cdot M_{LSH}) + (Ia_{EH} \cdot M_{EH2}))$	$MH_{Ia} = 54705.7 \frac{\text{lb}\cdot\text{ft}}{\text{ft}}$
$MH_{Ib} := \eta \cdot ((Ib_{LS} \cdot M_{LSH}) + (Ib_{EH} \cdot M_{EH2}))$	$MH_{Ib} = 54705.7 \frac{\text{lb}\cdot\text{ft}}{\text{ft}}$

Compute Bearing Resistance:

Compute the resultant location about the toe of the base length (distance from "O") Strength lb:

$\Sigma M_R := MV_{lb}$	$\Sigma M_R = 303286.5 \frac{\text{lb}\cdot\text{ft}}{\text{ft}}$	Sum of Resisting Moments (Strength lb)
$\Sigma M_O := MH_{lb}$	$\Sigma M_O = 54705.7 \frac{\text{lb}\cdot\text{ft}}{\text{ft}}$	Sum of Overturning Moments (Strength lb)
$\Sigma V := V_{lb}$	$\Sigma V = 40063.3 \frac{\text{lb}}{\text{ft}}$	Sum of Vertical Loads (Strength lb)
$x := \frac{(\Sigma M_R - \Sigma M_O)}{\Sigma V}$	$x = 6.2 \text{ ft}$	Distance from Point "O" the resultant intersects the base

$e := \left \frac{B}{2} - x \right $	$e = 0.3 \text{ ft}$	Wall eccentricity, Note: The vertical stress is assumed to be uniformly distributed over the effective bearing width, B', since the wall is supported by a soil foundation LRFD [11.6.3.2] . The effective bearing width is equal to B-2e. When the foundation eccentricity is negative the absolute value is used.
---------------------------------------	----------------------	---

Foundation Layout:

$B' := B - 2 \cdot e$	$B' = 12.4 \text{ ft}$	Effective Footing Width
$L' := 91 \text{ ft}$		Effective Footing Length (Assumed)
$H' := H_{lb}$	$H' = 8801.6 \frac{\text{lb}}{\text{ft}}$	Summation of Horizontal Loads (Strength lb)
$V' := V_{lb}$	$V' = 40063.3 \frac{\text{lb}}{\text{ft}}$	Summation of Vertical Loads (Strength lb)
$D_f = 3.5 \text{ ft}$		Footing embedment
$d_w := 0 \text{ ft}$		Depth of Groundwater below ground surface at front of wall.

Drained Conditions (Effective Stress):

$N_q := \text{if} \left(\phi'_{fd} > 0, e^{\pi \cdot \tan(\phi'_{fd})} \cdot \tan \left(45 \text{ deg} + \frac{\phi'_{fd}}{2} \right), 1.0 \right)$	$N_q = 7.82$
$N_c := \text{if} \left(\phi'_{fd} > 0, \frac{N_q - 1}{\tan(\phi'_{fd})}, 5.14 \right)$	$N_c = 16.88$
$N_\gamma := 2 \cdot (N_q + 1) \cdot \tan(\phi'_{fd})$	$N_\gamma = 7.1$

Compute shape correction factors per LRFD [Table 10.6.3.1.2a-3]:

$s_c := \text{if} \left(\phi'_{fd} > 0, 1 + \left(\frac{B'}{L'} \right) \cdot \left(\frac{N_q}{N_c} \right), 1 + \left(\frac{B'}{5 \cdot L'} \right) \right)$	$s_c = 1.063$
$s_q := \text{if} \left(\phi'_{fd} > 0, 1 + \left(\frac{B'}{L'} \right) \cdot \tan(\phi'_{fd}), 1 \right)$	$s_q = 1.055$
$s_\gamma := \text{if} \left(\phi'_{fd} > 0, 1 - 0.4 \cdot \left(\frac{B'}{L'} \right), 1 \right)$	$s_\gamma = 0.945$

Load inclination factors:

$$i_q := 1$$

$$i_\gamma := 1$$

$$i_c := 1$$

Assumed to be 1.0, see **LRFD BDS C10.6.3.1.2a**.
"Most geotechnical engineers do not use the load inclination factors". If desired, use LRFD Equations [10.6.3.1.2a-5] thru [10.6.3.1.2a-9].

Compute groundwater depth correction factors per LRFD [Table 10.6.3.1.2a-2]:

$$C_{wq} := \text{if}(d_w \geq D_f, 1.0, 0.5) \quad C_{wq} = 0.5$$

$$C_{wy} := \text{if}(d_w \geq (1.5 \cdot B) + D_f, 1.0, 0.5) \quad C_{wy} = 0.5$$

Depth Correction Factor per Hanson (1970):

$$d_q := \text{if}\left(\frac{D_f}{B} \leq 1, 1 + 2 \cdot \tan(\phi'_{fd}) \cdot (1 - \sin(\phi'_{fd}))^2 \cdot \frac{D_f}{B}, 1 + 2 \cdot \tan(\phi'_{fd}) \cdot (1 - \sin(\phi'_{fd}))^2 \cdot \text{atan}\left(\frac{D_f}{B}\right)\right)$$

$$d_q = 1.09$$

Compute modified bearing capacity factors LRFD [Equation 10.6.3.1.2a-2 to 10.6.3.1.2a-4]:

$$N_{cm} := N_c \cdot s_c \cdot i_c \quad N_{cm} = 17.949$$

$$N_{qm} := N_q \cdot s_q \cdot i_q \quad N_{qm} = 8.252$$

$$N_{\gamma m} := N_\gamma \cdot s_\gamma \cdot i_\gamma \quad N_{\gamma m} = 6.739$$

Compute nominal bearing resistance. LRFD [Eq 10.6.3.1.2a-1]:

$$q_{nd} := c'_{fd} \cdot N_{cm} + \gamma_{fd} \cdot D_f \cdot N_{qm} \cdot d_q \cdot C_{wq} + 0.5 \cdot \gamma_{fd} \cdot B' \cdot N_{\gamma m} \cdot C_{wy} \quad q_{nd} = 8251.7 \frac{\text{lb}}{\text{ft}^2}$$

Compute factored bearing resistance. LRFD [Eq 10.6.3.1.1]:

$$\phi_b := 0.55$$

Bearing resistance factor LRFD Table 11.5.7-1.

$$q_{Rd} := \phi_b \cdot q_{nd} \quad q_{Rd} = 4.5 \text{ ksf}$$

Factored bearing resistance Drained Conditions

Undrained Conditions (Effective Stress):

$$N_q := \text{if}\left(\phi_{fd} > 0, e^{\pi \cdot \tan(\phi_{fd})} \cdot \tan\left(45 \text{ deg} + \frac{\phi_{fd}}{2}\right), 1.0\right) \quad N_q = 1$$

$$N_c := \text{if}\left(\phi_{fd} > 0, \frac{N_q - 1}{\tan(\phi_{fd})}, 5.14\right) \quad N_c = 5.14$$

$$N_\gamma := 2 \cdot (N_q + 1) \cdot \tan(\phi_{fd}) \quad N_\gamma = 0$$

Compute shape correction factors per LRFD [Table 10.6.3.1.2a-3]:

$$s_c := \text{if} \left(\phi_{fd_u} > 0, 1 + \left(\frac{B'}{L'} \right) \cdot \left(\frac{N_q}{N_c} \right), 1 + \left(\frac{B'}{5 \cdot L'} \right) \right) \quad s_c = 1.027$$

$$s_q := \text{if} \left(\phi_{fd_u} > 0, 1 + \left(\frac{B'}{L'} \right) \cdot \tan(\phi_{fd_u}), 1 \right) \quad s_q = 1$$

$$s_\gamma := \text{if} \left(\phi_{fd_u} > 0, 1 - 0.4 \cdot \left(\frac{B'}{L'} \right), 1 \right) \quad s_\gamma = 1$$

Load inclination factors:

$$i_q := 1$$

$$i_\gamma := 1$$

$$i_c := 1$$

Assumed to be 1.0, see LRFD BDS C10.6.3.1.2a. "Most geotechnical engineers do not use the load inclination factors". If desired, use LRFD Equations [10.6.3.1.2a-5] thru [10.6.3.1.2a-9].

Compute modified bearing capacity factors LRFD [Equation 10.6.3.1.2a-2 to 10.6.3.1.2a-4]:

$$N_{cm} := N_c \cdot s_c \cdot i_c \quad N_{cm} = 5.28$$

$$N_{qm} := N_q \cdot s_q \cdot i_q \quad N_{qm} = 1$$

$$N_{\gamma m} := N_\gamma \cdot s_\gamma \cdot i_\gamma \quad N_{\gamma m} = 0$$

Depth Correction Factor per Hanson (1970):

$$d_q := \text{if} \left(\frac{D_f}{B} \leq 1, 1 + 2 \cdot \tan(\phi_{fd_u}) \cdot (1 - \sin(\phi_{fd_u}))^2 \cdot \frac{D_f}{B}, 1 + 2 \cdot \tan(\phi_{fd_u}) \cdot (1 - \sin(\phi_{fd_u}))^2 \cdot \text{atan} \left(\frac{D_f}{B} \right) \right)$$

$$d_q = 1$$

Compute nominal bearing resistance. LRFD [Eq 10.6.3.1.2a-1]:

$$q_{nu} := S u_{fd_u} \cdot N_{cm} + \gamma_{fd} \cdot D_f \cdot N_{qm} \cdot d_q \cdot C_{wq} + 0.5 \cdot \gamma_{fd} \cdot B' \cdot N_{\gamma m} \cdot C_{w\gamma} \quad q_{nu} = 11307.1 \frac{\text{lbf}}{\text{ft}^2}$$

Compute factored bearing resistance. LRFD [Eq 10.6.3.1.1]:

$$\phi_b := .55$$

$$q_{Ru} := \phi_b \cdot q_{nu} \quad q_{Ru} = 6.2 \text{ ksf}$$

Bearing resistance factor LRFD Table 11.5.7-1.

Factored bearing resistance Undrained Conditions

Factored Bearing Resistance Drained vs. Undrained Conditions:

Drained Conditions: $q_{Rd} = 4.5 \text{ ksf}$

Undrained Conditions: $q_{Ru} = 6.2 \text{ ksf}$

Evaluate External Stability of Wall:

Compute the ultimate bearing stress :

$$e = 0.3 \text{ ft}$$

$$\sigma_V := \frac{\Sigma V}{B - 2 \cdot e} \quad \sigma_V = 3.228 \text{ ksf}$$

Bearing Capacity:Demand Ratio (CDR)

Drained Conditions: $CDR_{Bearing_D} := \frac{q_{Rd}}{\sigma_V}$ Is the CDR > or = to 1.0? $CDR_{Bearing_D} = 1.41$

Undrained Conditions: $CDR_{Bearing_U} := \frac{q_{Ru}}{\sigma_V}$ Is the CDR > or = to 1.0? $CDR_{Bearing_U} = 1.93$

Limiting Eccentricity at Base of Wall (Strength Ia):

Compute the resultant location about the toe "O" of the base length (distance from Pivot):

$$e_{max} := \frac{B}{3}$$

$$e_{max} = 4.3 \text{ ft}$$

Maximum Eccentricity **LRFD [11.6.3.3.]**
Equals B/3 for soil.

$$\Sigma M_R := MV_{Ia}$$

$$\Sigma M_R = 224236.3 \frac{\text{lb} \cdot \text{ft}}{\text{ft}}$$

Sum of Resisting Moments (Strength Ia)

$$\Sigma M_O := MH_{Ia}$$

$$\Sigma M_O = 54705.7 \frac{\text{lb} \cdot \text{ft}}{\text{ft}}$$

Sum of Overturning Moments (Strength Ia)

$$\Sigma V := V_{Ia}$$

$$\Sigma V = 29037.9 \frac{\text{lb}}{\text{ft}}$$

Sum of Vertical Loads (Strength Ia)

$$x := \frac{(\Sigma M_R - \Sigma M_O)}{\Sigma V}$$

$$x = 5.8 \text{ ft}$$

Distance from Point "O" the resultant intersects the base

$$e := \text{abs} \left(\frac{B}{2} - x \right)$$

$$e = 0.66 \text{ ft}$$

Wall eccentricity, **Note:** The vertical stress is assumed to be uniformly distributed over the effective bearing width, B', since the wall is supported by a soil foundation **LRFD [11.6.3.2]**. The effective bearing width is equal to B-2e. .

Eccentricity Capacity:Demand Ratio (CDR)

$$CDR_{Eccentricity} := \frac{e_{max}}{e}$$

Is the CDR > or = to 1.0?

$$CDR_{Eccentricity} = 6.55$$

Sliding Resistance at Base of Wall LRFD [10.6.3.4]:

Factored Sliding Force (Strength Ia):

$$R_u := H_{Ia} \qquad R_u = 8801.6 \frac{\text{lb}f}{\text{ft}}$$

Drained Conditions (Effective Stress):

Compute passive resistance throughout the design life of the wall LRFD [Eq 3.11.5.4-1]:

$$r_{ep1} := (k_{pd} \cdot \gamma_{fd} \cdot y_1 + 2 \cdot c'_{fd} \cdot \sqrt{k_{pd}}) \cdot \cos(\delta_{fd}) \qquad \text{Nominal passive pressure at } y_1$$

$$r_{ep2} := (k_{pd} \cdot \gamma_{fd} \cdot y_2 + 2 \cdot c'_{fd} \cdot \sqrt{k_{pd}}) \cdot \cos(\delta_{fd}) \qquad \text{Nominal passive pressure at } y_2$$

$$R_{ep} := \frac{r_{ep1} + r_{ep2}}{2} \cdot (y_2 - y_1) \qquad R_{ep} = 0 \frac{\text{lb}f}{\text{ft}} \qquad \text{Nominal passive resistance Drained Conditions}$$

416 Note: Passive Resistance shall be neglected in stability computations, unless the base of the wall extends below the depth of maximum scour, freeze-thaw or other disturbances. In the latter case, only the embedment below the greater of these depths shall be considered effective LRFD [11.6.3.5].

Compute sliding resistance between soil and foundation:

$$c := 1.0 \qquad c = 1.0 \text{ for Cast-in-Place}$$

$$c = 0.8 \text{ for Precast}$$

$$\Sigma V := V_{Ia} \qquad \Sigma V = 29037.9 \frac{\text{lb}f}{\text{ft}} \qquad \text{Sum of Vertical Loads (Strength Ia)}$$

$$R_\tau := c \cdot \Sigma V \cdot \tan(\phi'_{fd}) \qquad R_\tau = 11732.1 \frac{\text{lb}f}{\text{ft}} \qquad \text{Nominal sliding resistance Cohesionless Soils}$$

Compute factored resistance against failure by sliding LRFD [10.6.3.4]:

$$\phi_{ep} := 0.5 \qquad \text{Resistance factor for passive resistance specified in LRFD Table 10.5.5.2.2-1}$$

$$\phi_\tau := 1.0 \qquad \text{Resistance factor for sliding resistance specified in LRFD Table 11.5.7-1.}$$

$$\phi R_n := \phi_\tau \cdot R_\tau + \phi_{ep} \cdot R_{ep} \qquad R_R := \phi R_n$$

Factored Sliding Resistance to be used in CDR Calculations: $R_R = 11732.06 \frac{\text{lb}f}{\text{ft}}$

Sliding Capacity:Demand Ratio (CDR)

$$CDR_{Sliding} := \frac{R_R}{R_u} \qquad \text{Is the CDR } > \text{ or } = \text{ to } 1.0? \qquad CDR_{Sliding} = 1.33$$

Undrained Conditions (Total Stress):

Compute passive resistance throughout the design life of the wall LRFD [Eq 3.11.5.4-1]:

$r_{ep1} := (k_{pu} \cdot \gamma_{fd} \cdot y_1 + 2 \cdot Su_{fd} \cdot \sqrt{k_{pu}}) \cdot \cos(\delta_{fd})$	Nominal passive pressure at y1
$r_{ep2} := (k_{pu} \cdot \gamma_{fd} \cdot y_2 + 2 \cdot Su_{fd} \cdot \sqrt{k_{pu}}) \cdot \cos(\delta_{fd})$	Nominal passive pressure at y2
$R_{ep} := \frac{r_{ep1} + r_{ep2}}{2} \cdot (y_2 - y_1)$	Nominal passive resistance Drained Conditions
$R_{ep} = 0 \frac{lbf}{ft}$	

416 Note: Passive Resistance shall be neglected in stability computations, unless the base of the wall extends below the depth of maximum scour, freeze-thaw or other disturbances. In the latter case, only the embedment below the greater of these depths shall be considered effective LRFD [11.6.3.5].

Compute sliding resistance between soil and foundation:

$c := 1.0$	$c = 1.0$ for Cast-in-Place $c = 0.8$ for Precast
$\Sigma V := V_{1a}$	$\Sigma V = 29037.9 \frac{lbf}{ft}$ Sum of Vertical Loads (Strength Ia)
$e = 0.66 \text{ ft}$	Wall eccentricity, Calculated in above <u>Limiting Eccentricity at Base of Wall (Strength Ia) Section.</u>
$B = 13 \text{ ft}$	Footing base width
$\frac{B}{6} = 2.2 \text{ ft}$	If $e < B/6$ the resultant is in the middle one-third
$\sigma_{vmax} := \frac{\Sigma V}{B} \cdot \left(1 + 6 \cdot \frac{e}{B}\right)$	$\sigma_{vmax} = 2915.9 \frac{lbf}{ft^2}$ Max vertical stress (if resultant is in the middle one-third of base) LRFD [11.6.3.2-2].
$\sigma_{vmin} := \frac{\Sigma V}{B} \cdot \left(1 - 6 \cdot \frac{e}{B}\right)$	$\sigma_{vmin} = 1551.5 \frac{lbf}{ft^2}$ Max vertical stress (if resultant is in the middle one-third of base) LRFD [11.6.3.2-2].
$q_{max} := \frac{1}{2} \cdot \sigma_{vmax}$	$q_{max} = 1457.9 \frac{lbf}{ft^2}$ Max unit shear resistance as 1/2 max vertical stress LRFD [10.6.3.4].
$q_{min} := \frac{1}{2} \cdot \sigma_{vmin}$	$q_{min} = 775.7 \frac{lbf}{ft^2}$ Minimum unit shear resistance as 1/2 minimum vertical stress LRFD [10.6.3.4].

Determine which Cohesive Soil Resistance Case is Present:

$Case_1 := \text{if}(q_{max} > Su_{fd} > q_{min} \geq 0, 1, 0)$	$Case_1 = 0$
$Case_2 := \text{if}(Su_{fd} > q_{max} > q_{min} \geq 0, 1, 0)$	$Case_2 = 1$
$Case_3 := \text{if}(q_{max} > q_{min} > Su_{fd}, 1, 0)$	$Case_3 = 0$
$Case_4 := \text{if}(q_{min} < 0, \text{if}(Su_{fd} < q_{max}, 1, 0), 0)$	$Case_4 = 0$
$Case_5 := \text{if}(q_{min} < 0, \text{if}(Su_{fd} > q_{max}, 1, 0), 0)$	$Case_5 = 0$

Unit Shear Resistance for Case 1:

$$S_1 := Su_{fdu} - q_{min} = 1324.3 \frac{\text{lb}}{\text{ft}^2}$$

$$B_1 := \frac{B \cdot (Su_{fdu} - q_{min})}{q_{max} - q_{min}} = 25.2 \text{ ft}$$

$$B_3 := B = 13 \text{ ft}$$

$$I := \frac{1}{2} \cdot S_1 \cdot B_1 = 16708.8 \frac{\text{lb}}{\text{ft}}$$

$$III := S_2 \cdot B_3 = 10084.6 \frac{\text{lb}}{\text{ft}}$$

$$R_{\tau_{case1}} := I + II + III = 10591.2 \frac{\text{lb}}{\text{ft}}$$

$$S_2 := q_{min} = 775.7 \frac{\text{lb}}{\text{ft}^2}$$

$$B_2 := \frac{B \cdot (q_{max} - Su_{fdu})}{q_{max} - q_{min}} = -12.2 \text{ ft}$$

$$II := S_1 \cdot B_2 = -16202.2 \frac{\text{lb}}{\text{ft}}$$

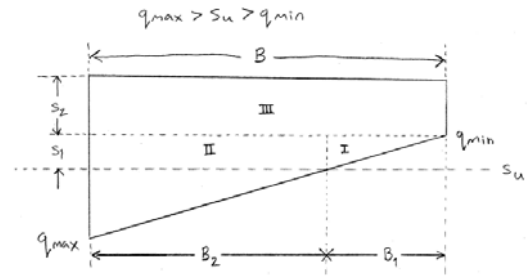

Unit Shear Resistance for Case 2:

$$S_1 := q_{max} - q_{min} = 682.2 \frac{\text{lb}}{\text{ft}^2}$$

$$B = 13 \text{ ft}$$

$$I := \frac{1}{2} \cdot S_1 \cdot B = 4434.3 \frac{\text{lb}}{\text{ft}}$$

$$R_{\tau_{case2}} := I + II = 14518.9 \frac{\text{lb}}{\text{ft}}$$

$$S_2 := q_{min} = 775.7 \frac{\text{lb}}{\text{ft}^2}$$

$$II := S_2 \cdot B = 10084.6 \frac{\text{lb}}{\text{ft}}$$

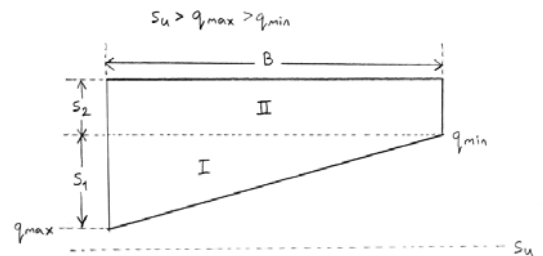

Unit Shear Resistance for Case 3:

$$S_1 := Su_{fdu} = 2100 \frac{\text{lb}}{\text{ft}^2}$$

$$B = 13 \text{ ft}$$

$$I := \frac{1}{2} \cdot S_1 \cdot B = 13650 \frac{\text{lb}}{\text{ft}}$$

$$R_{\tau_{case3}} := I = 13650 \frac{\text{lb}}{\text{ft}}$$

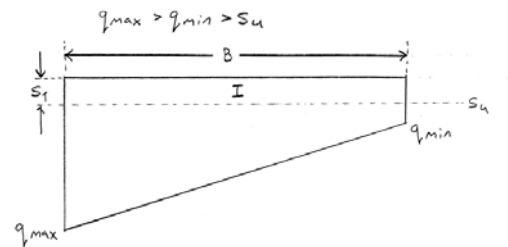

Unit Shear Resistance for Case 4:

$$S_1 := Su_{fdu} = 2100 \frac{\text{lb}}{\text{ft}^2}$$

$$B_3 := \frac{B \cdot (-q_{min})}{q_{max} - q_{min}} = -14.8 \text{ ft}$$

$$B_2 := B - (B_1 + B_3) = -12.2 \text{ ft}$$

$$I := \frac{1}{2} \cdot S_1 \cdot B_1 = 42018.1 \frac{\text{lb}}{\text{ft}}$$

$$R_{\tau_{case4}} := I + II = 16324.8 \frac{\text{lb}}{\text{ft}}$$

$$B_1 := \left(\frac{Su_{fdu}}{q_{max}} \right) \cdot (B - B_3) = 40 \text{ ft}$$

$$II := S_1 \cdot B_2 = -25693.3 \frac{\text{lb}}{\text{ft}}$$

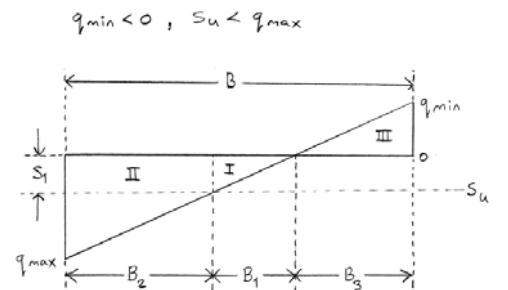

Unit Shear Resistance for Case 5:

$$S_1 := q_{max} = 1457.9 \frac{lbf}{ft^2}$$

$$B_1 := \frac{B \cdot q_{max}}{q_{max} - q_{min}} = 27.8 \text{ ft}$$

$$B_2 := B - B_1 = -14.8 \text{ ft}$$

$$I := \frac{1}{2} \cdot S_1 \cdot B_1 = 20252.5 \frac{lbf}{ft}$$

$$R_{\tau_{case5}} := I = 20252.5 \frac{lbf}{ft}$$

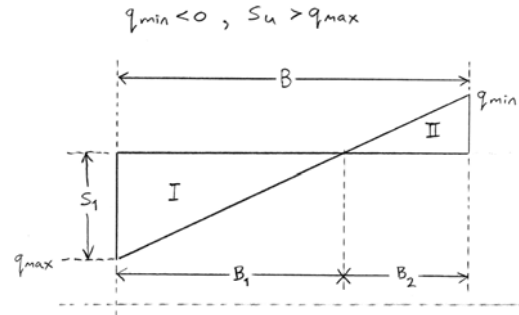

Define the Applicable Case:

$$R_{\tau} := R_{\tau_{case2}}$$

$$R_{\tau} = 14518.9 \frac{lbf}{ft}$$

Nominal sliding resistance Cohesive Soils

Compute factored resistance against failure by sliding **LRFD [10.6.3.4]:**

$$\phi_{ep} := 0.5$$

Resistance factor for passive resistance specified in **LRFD Table 10.5.5.2.2-1**

$$\phi_{\tau} := 1.0$$

Resistance factor for sliding resistance specified in **LRFD Table 11.5.7-1.**

$$\phi R_n := \phi_{\tau} \cdot R_{\tau} + \phi_{ep} \cdot R_{ep}$$

$$R_R := \phi R_n$$

Factored Sliding Resistance to be used in CDR Calculations:

$$R_R = 14518.934 \frac{lbf}{ft}$$

Sliding Capacity: Demand Ratio (CDR)

$$CDR_{Sliding} := \frac{R_R}{R_u}$$

Is the CDR > or = to 1.0?

$$CDR_{Sliding} = 1.65$$

RETAINING WALL 4

Objective: To evaluate the external stability of CIP wall's with level backfill (no backslope).
Method: In accordance with ODOT Bridge Design Manual, 2024 [Sect. 307] LRFD Bridge Design Specifications, 8th Ed., Nov. 2017, [Sect. 11.6.1, Sect. 11.6.2, and Sect. 11.6.3].

Givens:

Backfill Soil Design Parameters:

$$\phi'_f := 30 \text{ deg}$$

Effective angle of internal friction

$$\gamma_f := 120 \frac{\text{lb}}{\text{ft}^3}$$

Unit weight

$$c'_f := 0 \frac{\text{lb}}{\text{ft}^2}$$

Effective Cohesion

$$\delta := 0.67 \cdot \phi'_f$$

$$\delta = 20.1 \text{ deg}$$

Friction angle between backfill and wall taken as specified in **LRFD BDS C3.11.5.3 (degrees)**

Foundation Soil Design Parameters:

Drained Conditions (Effective Stress):

$$\phi'_{fd} := 22 \text{ deg}$$

Effective angle of internal friction

$$\gamma_{fd} := 125 \frac{\text{lb}}{\text{ft}^3}$$

Unit weight

$$c'_{fd} := 205 \frac{\text{lb}}{\text{ft}^2}$$

Effective Cohesion

$$\delta_{fd} := 0.67 \cdot \phi'_{fd}$$

$$\delta_{fd} = 14.7 \text{ deg}$$

Friction angle between foundation soils and footing taken as specified in **LRFD BDS C3.11.5.3 (degrees)**

Undrained Conditions (Total Stress):

$$\phi_{fdu} := 0 \text{ deg}$$

Angle of internal friction (Same as Drained Conditions if granular soils)

$$\gamma_{fd} = 125 \frac{\text{lb}}{\text{ft}^3}$$

Unit weight

$$Su_{fdu} := 2100 \frac{\text{lb}}{\text{ft}^2}$$

Undrained Shear Strength

$$\delta_{fdu} := 0.67 \cdot \phi_{fdu}$$

$$\delta_{fdu} = 0 \text{ deg}$$

Friction angle between foundation soils and footing taken as specified in **LRFD BDS C3.11.5.3 (degrees)**

Foundation Surcharge Soil Parameters:

$$\gamma_q := 120 \frac{\text{lb}}{\text{ft}^3}$$

Unit weight of Soil above bearing depth (Used in Bearing Resistance of Soil Calculation **LRFD 10.6.3.1.2a-1**)

Other Parameters:

$$\gamma_c := 150 \frac{\text{lb}}{\text{ft}^3}$$

Concrete Unit weight

$$\gamma_p := 150 \frac{\text{lb}}{\text{ft}^3}$$

Pavement Unit weight

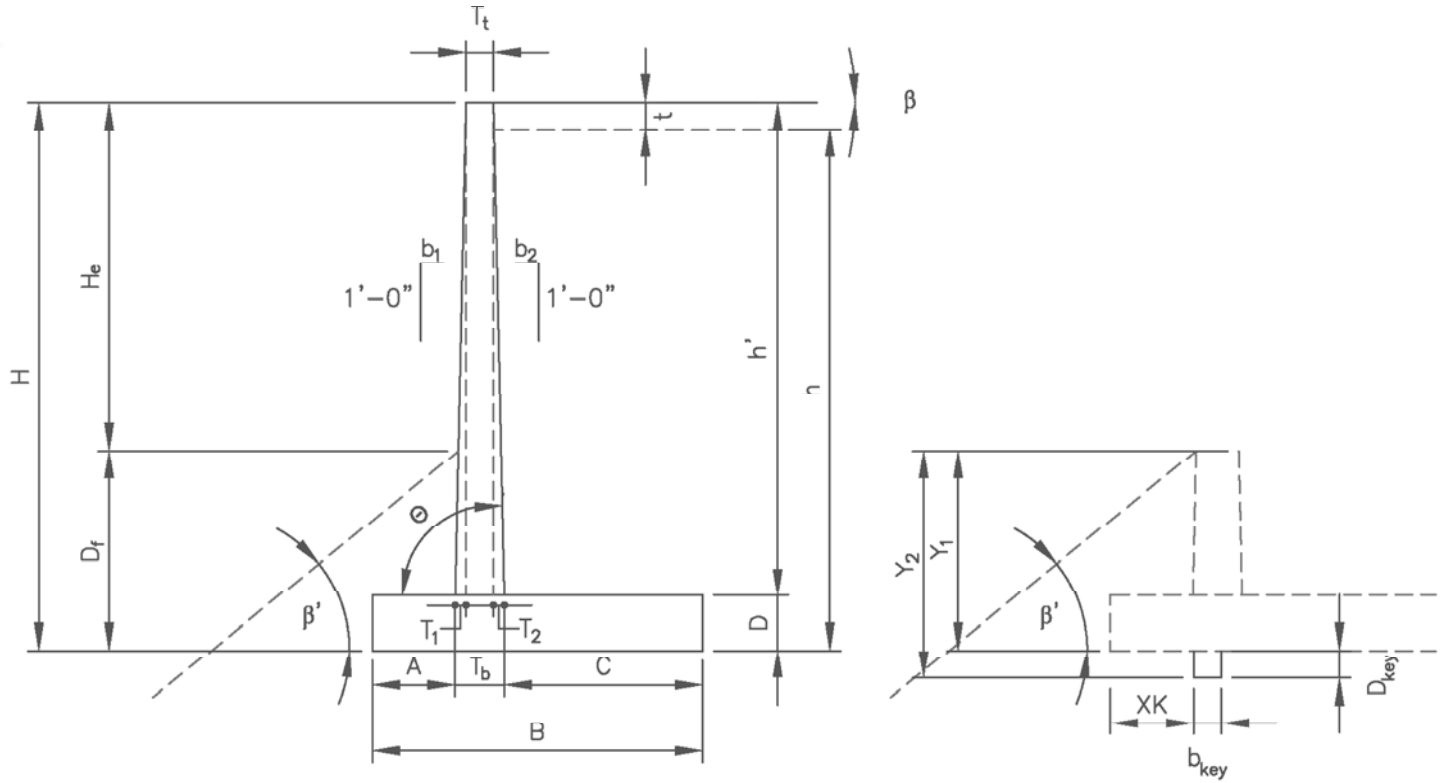

Wall Geometry:

$H_e := 9.15 \text{ ft}$

$D_f := 3.5 \text{ ft}$

$H := H_e + D_f$

$H = 12.7 \text{ ft}$

$T_t := 1 \text{ ft}$

$b_1 := 1.50 \cdot \left(\frac{\text{in}}{\text{ft}}\right)$

$b_2 := 0 \cdot \left(\frac{\text{in}}{\text{ft}}\right)$

$\beta := 0 \text{ deg}$

$\beta' := 0 \text{ deg}$

$t := 0.5 \cdot \text{ft}$

- Inclination of ground slope:
- Horizontal: **0**
 - 3H:1V: **18.435**
 - 2H:1V: **26.565**
 - 1.5H:1V: **33.690**

Exposed wall height

Footing cover at Toe

Note: Where the potential for scour, erosion of undermining exists, spread footings shall be located to bear below the maximum depth of scour or undermining. Spread footings shall be located below the depth of potential frost. **LRFD BDS 10.6.1.2.**

Design Wall Height

Stem thickness at top of wall

Frontwall batter, (b1H:12V)

Backwall batter, (b2H:12V)

Inclination of ground slope behind face of wall.
Horizontal backfill behind CIP wall, $\beta = 0 \text{ deg}$

Inclination of ground slope in front of wall. If it is horizontal backfill in front of CIP wall, $\beta' = 0 \text{ deg}$. A negative angle (-) indicates grades slope up from front of wall. Positive angle (+) indicates grade slope down from wall as shown in above figure.

Pavement thickness

Preliminary Wall Dimensioning:

$B := 11 \text{ ft}$	$\frac{2}{5} \cdot H = 5.06 \text{ ft}$ to $\frac{3}{5} \cdot H = 7.59 \text{ ft}$	Footing base width (2/5H to 3/5H)
$A := 1.5 \text{ ft}$	$\frac{H}{8} = 1.58 \text{ ft}$ to $\frac{H}{5} = 2.53 \text{ ft}$	Toe projection (H/8 to H/5)
$D := 2 \text{ ft}$	$\frac{H}{8} = 1.58 \text{ ft}$ to $\frac{H}{5} = 2.53 \text{ ft}$	Footing thickness (H/8 to H/5)

Shear Key Dimensioning:

$D_{key} := 0 \text{ ft}$	Depth of shear key from bottom of footing Note: Footings on rock typically require shear key
$b_{key} := 0 \text{ ft}$	Width of shear key
$XK := A$	Distance from toe to shear key

Other Wall Dimensions:

$h' := H - D$	$h' = 10.7 \text{ ft}$	Stem height
$T_1 := b_1 \cdot h'$	$T_1 = 1.331 \text{ ft}$	Stem front batter width
$T_2 := b_2 \cdot h'$	$T_2 = 0 \text{ ft}$	Stem back batter width
$T_b := T_1 + T_2 + T_t$	$T_b = 2.331 \text{ ft}$	Stem thickness at bottom of wall
$C := B - A - T_b$	$C = 7.169 \text{ ft}$	Heel projection
$\theta := 90 \text{ deg}$		Angle of back face of wall to horizontal = $atan(12/b_2)$
$b := 12 \text{ in}$	$b = 1 \text{ ft}$	Concrete strip width (for design)
$y_1 := 3.5 \cdot \text{ft}$	$y_1 = 3.5 \text{ ft}$	Depth to where passive pressure may begin to be utilized in front of wall. (Typically Df)
$y_2 := D_f + D_{key}$	$y_2 = 3.5 \text{ ft}$	Bottom of shear key/footing depth i.e. depth to where passive pressure may no longer be utilized.
$h := H - t$	$h = 12.2 \text{ ft}$	Height of retained fill at back of heel

Live Load Surcharge Parameters:

$\lambda := 20 \text{ ft}$	Horizontal distance from the back of the wall to point of traffic surcharge load
$SUR := \text{if} \left(\lambda < \frac{H}{2}, 250 \frac{\text{lb}}{\text{ft}^2}, 100 \frac{\text{lb}}{\text{ft}^2} \right) = 100 \frac{\text{lb}}{\text{ft}^2}$	Live load surcharge (per LRFD BDS [3.11.6.4]) Note: If vehicular loading is within 1 ft of the backface of the wall and with a design height, H, less than 20 ft, see LRFD BDS Section 3.11.6.4 and Table 3.11.6.4-2 for adjusted surcharge load calculation. Note: when $\lambda < H/2$, SUR equal 100 psf to account for construction loads

Calculations:

Earth Pressure Coefficients:

Backfill Active Earth:

$$\Gamma := \left(1 + \sqrt{\frac{(\sin(\phi'_f + \delta) \cdot \sin(\phi'_f - \beta))}{(\sin(\theta - \delta) \cdot \sin(\theta + \beta))}} \right)^2 \quad \Gamma = 2.687$$

$$k_{af} := \left(\frac{(\sin(\theta + \phi'_f))^2}{(\Gamma \cdot (\sin(\theta))^2 \cdot \sin(\theta - \delta))} \right) \quad k_{af} = 0.297 \quad \text{Active Earth Pressure Coefficient (per LRFD Sect. 3.11.5.3)}$$

Foundation Soil Passive Earth:

Drained Conditions assuming ($\phi'_{fd} > 0$):

Input Parameters for **LRFD Figure 3.11.5.4-2**, assumes $\theta = 90$ degrees

$$\frac{-\beta'}{\phi'_{fd}} = 0$$

$$\frac{-\delta_{fd}}{\phi'_{fd}} = -0.67$$

$$k'_p := 3.54$$

Passive Earth Pressure Coefficient from **LRFD Figure 3.11.5.4-2**

Determine Reduction Factor (R) by interpolation:

$$R_d := 0.828$$

Reduction Factor

$$k_{pd} := R_d \cdot k'_p \quad k_{pd} = 2.931$$

Passive Earth Pressure Coefficient for Drained Conditions

Undrained Conditions ($\phi'_{fdu} > 0$): **Note:** Expand window below to complete calculation

Undrained Conditions:

$$k_{pu} := \text{if}(\phi'_{fdu} > 0, k_{pu}, 1) \quad k_{pu} = 1$$

Passive Earth Pressure Coefficient for Resistance Undrained Conditions

Compute Unfactored Loads LRFD [Tables 3.4.1-1 and 3.4.1-2]:

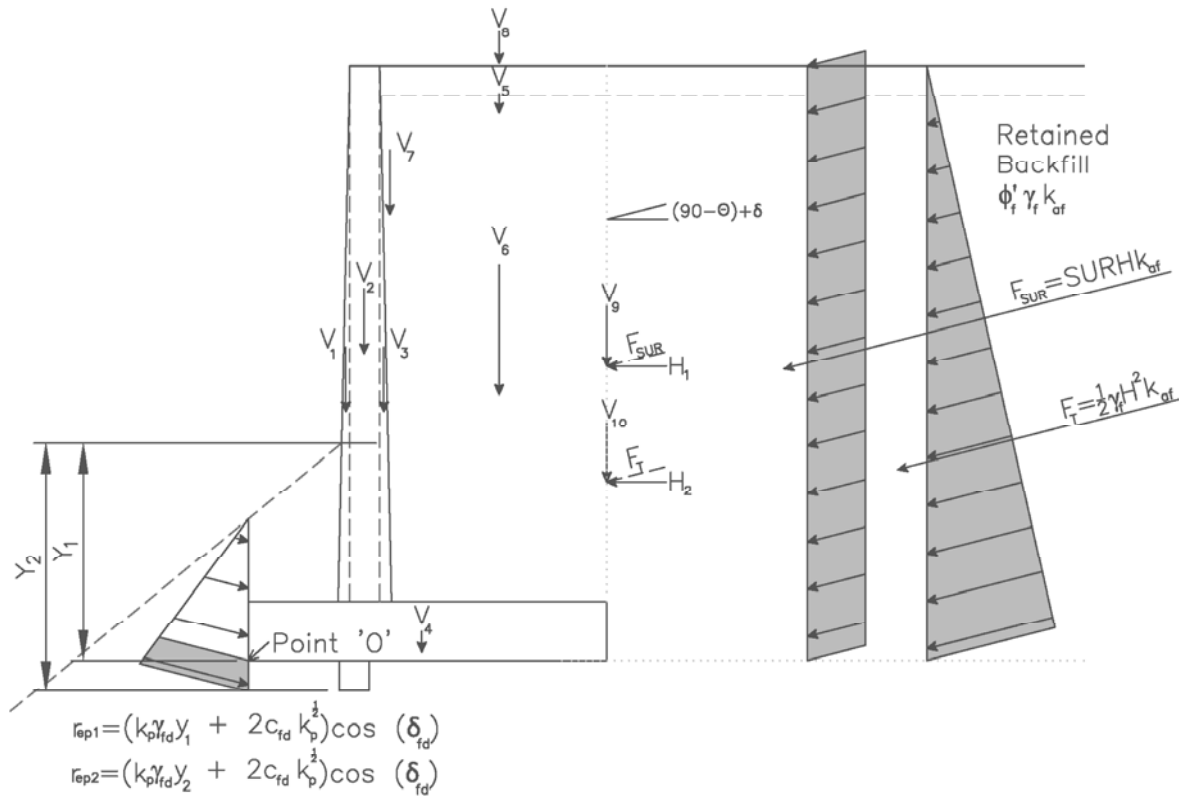

$$F_T := \frac{1}{2} \cdot \gamma_f \cdot H^2 \cdot k_{af}$$

$$F_{SUR} := SUR \cdot H \cdot k_{af}$$

Vertical Loads:

$$V_1 := \frac{1}{2} \cdot T_1 \cdot h' \cdot \gamma_c$$

$$V_2 := T_t \cdot h' \cdot \gamma_c$$

$$V_3 := \frac{1}{2} \cdot T_2 \cdot h' \cdot \gamma_c$$

$$V_4 := D \cdot B \cdot \gamma_c$$

$$V_5 := t \cdot (T_2 + C) \cdot \gamma_p$$

$$V_6 := C \cdot (h' - t) \cdot \gamma_f$$

$$V_7 := \frac{1}{2} \cdot b_2 \cdot (h' - t)^2 \cdot \gamma_f$$

$$V_8 := SUR \cdot (T_2 + C)$$

$$V_9 := F_{SUR} \cdot \sin(90 \cdot \text{deg} - \theta + \delta)$$

$$V_{10} := F_T \cdot \sin(90 \cdot \text{deg} - \theta + \delta)$$

$$F_T = 2854.1 \frac{\text{lbf}}{\text{ft}}$$

$$F_{SUR} = 376 \frac{\text{lbf}}{\text{ft}}$$

$$V_1 = 1063.3 \frac{\text{lbf}}{\text{ft}}$$

$$V_2 = 1597.5 \frac{\text{lbf}}{\text{ft}}$$

$$V_3 = 0 \frac{\text{lbf}}{\text{ft}}$$

$$V_4 = 3300 \frac{\text{lbf}}{\text{ft}}$$

$$V_5 = 537.7 \frac{\text{lbf}}{\text{ft}}$$

$$V_6 = 8731.5 \frac{\text{lbf}}{\text{ft}}$$

$$V_7 = 0 \frac{\text{lbf}}{\text{ft}}$$

$$V_8 = 716.9 \frac{\text{lbf}}{\text{ft}}$$

$$V_9 = 129.2 \frac{\text{lbf}}{\text{ft}}$$

$$V_{10} = 980.8 \frac{\text{lbf}}{\text{ft}}$$

Active Earth Force Resultant (EH)

Live Load Surcharge (LS)

Wall stem front batter (DC)

Wall stem (DC)

Wall stem back batter (DC)

Wall Footing (DC)

Pavement (DC)

Soil Backfill - Heel (EV)

Soil Backfill - Batter (EV)

Live Load Surcharge above Heel- (LS)
- Strength lb

Live Load Surcharge Resultant (vertical
comp. - LS) - Strength la

Active earth force resultant (vertical
component - EH)

Moment Arm:

Moments produced from vertical loads about Point 'O'

$$d_{v1} := A + \frac{2}{3} \cdot T_1 = 2.4 \text{ ft}$$

$$d_{v2} := A + T_1 + \frac{T_1}{2} = 3.3 \text{ ft}$$

$$d_{v3} := A + T_1 + T_1 + \frac{T_2}{3} = 3.8 \text{ ft}$$

$$d_{v4} := \frac{B}{2} = 5.5 \text{ ft}$$

$$d_{v5} := B - \frac{T_2 + C}{2} = 7.4 \text{ ft}$$

$$d_{v6} := B - \frac{C}{2} = 7.4 \text{ ft}$$

$$d_{v7} := A + T_1 + T_1 + \left(\frac{2}{3} \cdot b_2 \cdot (h' - t) \right) = 3.8 \text{ ft}$$

$$d_{v8} := B - \frac{T_2 + C}{2} = 7.4 \text{ ft}$$

$$d_{v9} := B = 11 \text{ ft}$$

$$d_{v10} := B = 11 \text{ ft}$$

Horizontal Loads:

$$H_1 := F_{SUR} \cdot \cos(90 \cdot \text{deg} - \theta + \delta) \quad H_1 = 353.1 \frac{\text{lbf}}{\text{ft}}$$

$$H_2 := F_T \cdot \cos(90 \cdot \text{deg} - \theta + \delta) \quad H_2 = 2680.3 \frac{\text{lbf}}{\text{ft}}$$

Moment Arm:

$$d_{h1} := \frac{H}{2} \quad d_{h1} = 6.3 \text{ ft}$$

$$d_{h2} := \frac{H}{3} \quad d_{h2} = 4.2 \text{ ft}$$

Unfactored Loads by Load Type:

$$V_{DC} := V_1 + V_2 + V_3 + V_4 + V_5 \quad V_{DC} = 6498.5 \frac{\text{lbf}}{\text{ft}}$$

$$V_{LS_Ia} := V_9 \quad V_{LS_Ia} = 129.2 \frac{\text{lbf}}{\text{ft}}$$

$$V_{EH} := V_{10} \quad V_{EH} = 980.8 \frac{\text{lbf}}{\text{ft}}$$

$$H_{EH} := H_2 \quad H_{EH} = 2680.3 \frac{\text{lbf}}{\text{ft}}$$

Moment:

$$MV_1 := V_1 \cdot d_{v1} = 2538.7 \text{ lbf}$$

$$MV_2 := V_2 \cdot d_{v2} = 5321.7 \text{ lbf}$$

$$MV_3 := V_3 \cdot d_{v3} = 0 \text{ lbf}$$

$$MV_4 := V_4 \cdot d_{v4} = 18150 \text{ lbf}$$

$$MV_5 := V_5 \cdot d_{v5} = 3987.1 \text{ lbf}$$

$$MV_6 := V_6 \cdot d_{v6} = 64749.8 \text{ lbf}$$

$$MV_7 := V_7 \cdot d_{v7} = 0 \text{ lbf}$$

$$MV_8 := V_8 \cdot d_{v8} = 5316.1 \text{ lbf}$$

$$MV_9 := V_9 \cdot d_{v9} = 1421.5 \text{ lbf}$$

$$MV_{10} := V_{10} \cdot d_{v10} = 10789.2 \text{ lbf}$$

Live Load Surcharge Resultant (horizontal comp. - LS)

Active Earth Force Resultant (horizontal comp. - EH)

Moment:

$$MH_1 := H_1 \cdot d_{h1} \quad MH_1 = 2233.6 \frac{\text{lbf} \cdot \text{ft}}{\text{ft}}$$

$$MH_2 := H_2 \cdot d_{h2} \quad MH_2 = 11301.8 \frac{\text{lbf} \cdot \text{ft}}{\text{ft}}$$

$$V_{EV} := V_6 + V_7 \quad V_{EV} = 8731.5 \frac{\text{lbf}}{\text{ft}}$$

$$V_{LS_Ib} := V_8 + V_9 \quad V_{LS_Ib} = 846.1 \frac{\text{lbf}}{\text{ft}}$$

$$H_{LS} := H_1 \quad H_{LS} = 353.1 \frac{\text{lbf}}{\text{ft}}$$

Unfactored Moments by Load Type

$M_{DC} := MV_1 + MV_2 + MV_3 + MV_4 + MV_5$	$M_{DC} = 29997.4 \frac{\text{lb}\cdot\text{ft}}{\text{ft}}$
$M_{EV} := MV_6 + MV_7$	$M_{EV} = 64749.8 \frac{\text{lb}\cdot\text{ft}}{\text{ft}}$
$M_{LSV_Ia} := MV_9$	$M_{LSV_Ia} = 1421.5 \frac{\text{lb}\cdot\text{ft}}{\text{ft}}$
$M_{LSV_Ib} := MV_8 + MV_9$	$M_{LSV_Ib} = 6737.6 \frac{\text{lb}\cdot\text{ft}}{\text{ft}}$
$M_{EH1} := MV_{10}$	$M_{EH1} = 10789.2 \frac{\text{lb}\cdot\text{ft}}{\text{ft}}$
$M_{LSH} := MH_1$	$M_{LSH} = 2233.6 \frac{\text{lb}\cdot\text{ft}}{\text{ft}}$
$M_{EH2} := MH_2$	$M_{EH2} = 11301.8 \frac{\text{lb}\cdot\text{ft}}{\text{ft}}$

Load Combination Limit States:

$\eta := 1$ LRFD Load Modifier
 Strength Limit State I: EV(min) = 1.00 EV(max) = 1.35
 EH(min) = 0.90 EH(max) = 1.50
 LS = 1.75

Strength Limit State Ia: (Sliding and Eccentricity)	$Ia_{DC} := 0.9$	$Ia_{EV} := 1$	$Ia_{EH} := 1.5$	$Ia_{LS} := 1.75$
Strength Limit State Ib: (Bearing Capacity)	$Ib_{DC} := 1.25$	$Ib_{EV} := 1.35$	$Ib_{EH} := 1.5$	$Ib_{LS} := 1.75$

Factored Vertical Loads by Limit State:

$V_{Ia} := \eta \cdot ((Ia_{DC} \cdot V_{DC}) + (Ia_{EV} \cdot V_{EV}) + (Ia_{EH} \cdot V_{EH}) + (Ia_{LS} \cdot V_{LS_Ia}))$	$V_{Ia} = 16277.6 \frac{\text{lb}}{\text{ft}}$
$V_{Ib} := \eta \cdot ((Ib_{DC} \cdot V_{DC}) + (Ib_{EV} \cdot V_{EV}) + (Ib_{EH} \cdot V_{EH}) + (Ib_{LS} \cdot V_{LS_Ib}))$	$V_{Ib} = 22862.6 \frac{\text{lb}}{\text{ft}}$

Factored Horizontal Loads by Limit State:

$H_{Ia} := \eta \cdot ((Ia_{LS} \cdot H_{LS}) + (Ia_{EH} \cdot H_{EH}))$	$H_{Ia} = 4638.4 \frac{\text{lb}}{\text{ft}}$
$H_{Ib} := \eta \cdot ((Ib_{LS} \cdot H_{LS}) + (Ib_{EH} \cdot H_{EH}))$	$H_{Ib} = 4638.4 \frac{\text{lb}}{\text{ft}}$

Factored Moments Produced by Vertical Loads by Limit State:

$MV_{Ia} := \eta \cdot ((Ia_{DC} \cdot M_{DC}) + (Ia_{EV} \cdot M_{EV}) + (Ia_{EH} \cdot M_{EH1}) + (Ia_{LS} \cdot M_{LSV_Ia}))$	$MV_{Ia} = 110419 \frac{\text{lb}\cdot\text{ft}}{\text{ft}}$
$MV_{Ib} := \eta \cdot ((Ib_{DC} \cdot M_{DC}) + (Ib_{EV} \cdot M_{EV}) + (Ib_{EH} \cdot M_{EH1}) + (Ib_{LS} \cdot M_{LSV_Ib}))$	$MV_{Ib} = 152883.6 \frac{\text{lb}\cdot\text{ft}}{\text{ft}}$

Factored Moments Produced by Horizontal Loads by Limit State:

$MH_{Ia} := \eta \cdot ((Ia_{LS} \cdot M_{LSH}) + (Ia_{EH} \cdot M_{EH2}))$	$MH_{Ia} = 20861.4 \frac{\text{lb}\cdot\text{ft}}{\text{ft}}$
$MH_{Ib} := \eta \cdot ((Ib_{LS} \cdot M_{LSH}) + (Ib_{EH} \cdot M_{EH2}))$	$MH_{Ib} = 20861.4 \frac{\text{lb}\cdot\text{ft}}{\text{ft}}$

Compute Bearing Resistance:

Compute the resultant location about the toe of the base length (distance from "O") Strength lb:

$\Sigma M_R := MV_{lb}$	$\Sigma M_R = 152883.6 \frac{\text{lb}\cdot\text{ft}}{\text{ft}}$	Sum of Resisting Moments (Strength lb)
$\Sigma M_O := MH_{lb}$	$\Sigma M_O = 20861.4 \frac{\text{lb}\cdot\text{ft}}{\text{ft}}$	Sum of Overturning Moments (Strength lb)
$\Sigma V := V_{lb}$	$\Sigma V = 22862.6 \frac{\text{lb}}{\text{ft}}$	Sum of Vertical Loads (Strength lb)
$x := \frac{(\Sigma M_R - \Sigma M_O)}{\Sigma V}$	$x = 5.8 \text{ ft}$	Distance from Point "O" the resultant intersects the base

$e := \left \frac{B}{2} - x \right $	$e = 0.27 \text{ ft}$	Wall eccentricity, Note: The vertical stress is assumed to be uniformly distributed over the effective bearing width, B', since the wall is supported by a soil foundation LRFD [11.6.3.2] . The effective bearing width is equal to B-2e. When the foundation eccentricity is negative the absolute value is used.
---------------------------------------	-----------------------	---

Foundation Layout:

$B' := B - 2 \cdot e$	$B' = 10.5 \text{ ft}$	Effective Footing Width
$L' := 36 \text{ ft}$		Effective Footing Length (Assumed)
$H' := H_{lb}$	$H' = 4638.4 \frac{\text{lb}}{\text{ft}}$	Summation of Horizontal Loads (Strength lb)
$V' := V_{lb}$	$V' = 22862.6 \frac{\text{lb}}{\text{ft}}$	Summation of Vertical Loads (Strength lb)
$D_f = 3.5 \text{ ft}$		Footing embedment
$d_w := 0 \text{ ft}$		Depth of Groundwater below ground surface at front of wall.

Drained Conditions (Effective Stress):

$N_q := \text{if} \left(\phi'_{fd} > 0, e^{\pi \cdot \tan(\phi'_{fd})} \cdot \tan \left(45 \text{ deg} + \frac{\phi'_{fd}}{2} \right), 1.0 \right)$	$N_q = 7.82$
$N_c := \text{if} \left(\phi'_{fd} > 0, \frac{N_q - 1}{\tan(\phi'_{fd})}, 5.14 \right)$	$N_c = 16.88$
$N_\gamma := 2 \cdot (N_q + 1) \cdot \tan(\phi'_{fd})$	$N_\gamma = 7.1$

Compute shape correction factors per LRFD [Table 10.6.3.1.2a-3]:

$s_c := \text{if} \left(\phi'_{fd} > 0, 1 + \left(\frac{B'}{L'} \right) \cdot \left(\frac{N_q}{N_c} \right), 1 + \left(\frac{B'}{5 \cdot L'} \right) \right)$	$s_c = 1.134$
$s_q := \text{if} \left(\phi'_{fd} > 0, 1 + \left(\frac{B'}{L'} \right) \cdot \tan(\phi'_{fd}), 1 \right)$	$s_q = 1.117$
$s_\gamma := \text{if} \left(\phi'_{fd} > 0, 1 - 0.4 \cdot \left(\frac{B'}{L'} \right), 1 \right)$	$s_\gamma = 0.884$

Load inclination factors:

$$i_q := 1$$

$$i_\gamma := 1$$

$$i_c := 1$$

Assumed to be 1.0, see **LRFD BDS C10.6.3.1.2a**.
"Most geotechnical engineers do not use the load inclination factors". If desired, use LRFD Equations [10.6.3.1.2a-5] thru [10.6.3.1.2a-9].

Compute groundwater depth correction factors per LRFD [Table 10.6.3.1.2a-2]:

$$C_{wq} := \text{if}(d_w \geq D_f, 1.0, 0.5) \quad C_{wq} = 0.5$$

$$C_{wy} := \text{if}(d_w \geq (1.5 \cdot B) + D_f, 1.0, 0.5) \quad C_{wy} = 0.5$$

Depth Correction Factor per Hanson (1970):

$$d_q := \text{if}\left(\frac{D_f}{B} \leq 1, 1 + 2 \cdot \tan(\phi'_{fd}) \cdot (1 - \sin(\phi'_{fd}))^2 \cdot \frac{D_f}{B}, 1 + 2 \cdot \tan(\phi'_{fd}) \cdot (1 - \sin(\phi'_{fd}))^2 \cdot \text{atan}\left(\frac{D_f}{B}\right)\right)$$

$$d_q = 1.1$$

Compute modified bearing capacity factors LRFD [Equation 10.6.3.1.2a-2 to 10.6.3.1.2a-4]:

$$N_{cm} := N_c \cdot s_c \cdot i_c \quad N_{cm} = 19.153$$

$$N_{qm} := N_q \cdot s_q \cdot i_q \quad N_{qm} = 8.738$$

$$N_{\gamma m} := N_\gamma \cdot s_\gamma \cdot i_\gamma \quad N_{\gamma m} = 6.3$$

Compute nominal bearing resistance. LRFD [Eq 10.6.3.1.2a-1]:

$$q_{nd} := c'_{fd} \cdot N_{cm} + \gamma_{fd} \cdot D_f \cdot N_{qm} \cdot d_q \cdot C_{wq} + 0.5 \cdot \gamma_{fd} \cdot B' \cdot N_{\gamma m} \cdot C_{wy} \quad q_{nd} = 8087.8 \frac{\text{lb}}{\text{ft}^2}$$

Compute factored bearing resistance. LRFD [Eq 10.6.3.1.1]:

$$\phi_b := 0.55$$

Bearing resistance factor LRFD Table 11.5.7-1.

$$q_{Rd} := \phi_b \cdot q_{nd} \quad q_{Rd} = 4.4 \text{ ksf}$$

Factored bearing resistance Drained Conditions

Undrained Conditions (Effective Stress):

$$N_q := \text{if}\left(\phi_{fd} > 0, e^{\pi \cdot \tan(\phi_{fd})} \cdot \tan\left(45 \text{ deg} + \frac{\phi_{fd}}{2}\right), 1.0\right) \quad N_q = 1$$

$$N_c := \text{if}\left(\phi_{fd} > 0, \frac{N_q - 1}{\tan(\phi_{fd})}, 5.14\right) \quad N_c = 5.14$$

$$N_\gamma := 2 \cdot (N_q + 1) \cdot \tan(\phi_{fd}) \quad N_\gamma = 0$$

Compute shape correction factors per LRFD [Table 10.6.3.1.2a-3]:

$$s_c := \text{if} \left(\phi_{fd_u} > 0, 1 + \left(\frac{B'}{L'} \right) \cdot \left(\frac{N_q}{N_c} \right), 1 + \left(\frac{B'}{5 \cdot L'} \right) \right) \quad s_c = 1.058$$

$$s_q := \text{if} \left(\phi_{fd_u} > 0, 1 + \left(\frac{B'}{L'} \cdot \tan(\phi_{fd_u}) \right), 1 \right) \quad s_q = 1$$

$$s_\gamma := \text{if} \left(\phi_{fd_u} > 0, 1 - 0.4 \cdot \left(\frac{B'}{L'} \right), 1 \right) \quad s_\gamma = 1$$

Load inclination factors:

$$i_q := 1$$

$$i_\gamma := 1$$

$$i_c := 1$$

Assumed to be 1.0, see LRFD BDS C10.6.3.1.2a. "Most geotechnical engineers do not use the load inclination factors". If desired, use LRFD Equations [10.6.3.1.2a-5] thru [10.6.3.1.2a-9].

Compute modified bearing capacity factors LRFD [Equation 10.6.3.1.2a-2 to 10.6.3.1.2a-4]:

$$N_{cm} := N_c \cdot s_c \cdot i_c \quad N_{cm} = 5.438$$

$$N_{qm} := N_q \cdot s_q \cdot i_q \quad N_{qm} = 1$$

$$N_{\gamma m} := N_\gamma \cdot s_\gamma \cdot i_\gamma \quad N_{\gamma m} = 0$$

Depth Correction Factor per Hanson (1970):

$$d_q := \text{if} \left(\frac{D_f}{B} \leq 1, 1 + 2 \cdot \tan(\phi_{fd_u}) \cdot (1 - \sin(\phi_{fd_u}))^2 \cdot \frac{D_f}{B}, 1 + 2 \cdot \tan(\phi_{fd_u}) \cdot (1 - \sin(\phi_{fd_u}))^2 \cdot \text{atan} \left(\frac{D_f}{B} \right) \right)$$

$$d_q = 1$$

Compute nominal bearing resistance. LRFD [Eq 10.6.3.1.2a-1]:

$$q_{nu} := Su_{fd_u} \cdot N_{cm} + \gamma_{fd} \cdot D_f \cdot N_{qm} \cdot d_q \cdot C_{wq} + 0.5 \cdot \gamma_{fd} \cdot B' \cdot N_{\gamma m} \cdot C_{w\gamma} \quad q_{nu} = 11639.5 \frac{\text{lbf}}{\text{ft}^2}$$

Compute factored bearing resistance. LRFD [Eq 10.6.3.1.1]:

$$\phi_b := .55$$

$$q_{Ru} := \phi_b \cdot q_{nu} \quad q_{Ru} = 6.4 \text{ ksf}$$

Bearing resistance factor LRFD Table 11.5.7-1.

Factored bearing resistance Undrained Conditions

Factored Bearing Resistance Drained vs. Undrained Conditions:

Drained Conditions: $q_{Rd} = 4.4 \text{ ksf}$

Undrained Conditions: $q_{Ru} = 6.4 \text{ ksf}$

Evaluate External Stability of Wall:

Compute the ultimate bearing stress :

$$e = 0.27 \text{ ft}$$

$$\sigma_V := \frac{\Sigma V}{B - 2 \cdot e} \quad \sigma_V = 2.188 \text{ ksf}$$

Bearing Capacity:Demand Ratio (CDR)

Drained Conditions: $CDR_{Bearing_D} := \frac{q_{Rd}}{\sigma_V}$ Is the CDR > or = to 1.0? $CDR_{Bearing_D} = 2.03$

Undrained Conditions: $CDR_{Bearing_U} := \frac{q_{Ru}}{\sigma_V}$ Is the CDR > or = to 1.0? $CDR_{Bearing_U} = 2.93$

Limiting Eccentricity at Base of Wall (Strength Ia):

Compute the resultant location about the toe "O" of the base length (distance from Pivot):

$$e_{max} := \frac{B}{3}$$

$$e_{max} = 3.7 \text{ ft}$$

Maximum Eccentricity **LRFD [11.6.3.3.]**
Equals B/3 for soil.

$$\Sigma M_R := MV_{Ia}$$

$$\Sigma M_R = 110419 \frac{\text{lb} \cdot \text{ft}}{\text{ft}}$$

Sum of Resisting Moments (Strength Ia)

$$\Sigma M_O := MH_{Ia}$$

$$\Sigma M_O = 20861.4 \frac{\text{lb} \cdot \text{ft}}{\text{ft}}$$

Sum of Overturning Moments (Strength Ia)

$$\Sigma V := V_{Ia}$$

$$\Sigma V = 16277.6 \frac{\text{lb}}{\text{ft}}$$

Sum of Vertical Loads (Strength Ia)

$$x := \frac{(\Sigma M_R - \Sigma M_O)}{\Sigma V}$$

$$x = 5.5 \text{ ft}$$

Distance from Point "O" the resultant intersects the base

$$e := \text{abs} \left(\frac{B}{2} - x \right)$$

$$e = 0 \text{ ft}$$

Wall eccentricity, **Note:** The vertical stress is assumed to be uniformly distributed over the effective bearing width, B', since the wall is supported by a soil foundation **LRFD [11.6.3.2]**. The effective bearing width is equal to B-2e. .

Eccentricity Capacity:Demand Ratio (CDR)

$$CDR_{Eccentricity} := \frac{e_{max}}{e}$$

Is the CDR > or = to 1.0?

$$CDR_{Eccentricity} = 1935.33$$

Sliding Resistance at Base of Wall LRFD [10.6.3.4]:

Factored Sliding Force (Strength Ia):

$$R_u := H_{Ia} \qquad R_u = 4638.4 \frac{\text{lb}}{\text{ft}}$$

Drained Conditions (Effective Stress):

Compute passive resistance throughout the design life of the wall LRFD [Eq 3.11.5.4-1]:

$$r_{ep1} := (k_{pd} \cdot \gamma_{fd} \cdot y_1 + 2 \cdot c'_{fd} \cdot \sqrt{k_{pd}}) \cdot \cos(\delta_{fd}) \qquad \text{Nominal passive pressure at } y_1$$

$$r_{ep2} := (k_{pd} \cdot \gamma_{fd} \cdot y_2 + 2 \cdot c'_{fd} \cdot \sqrt{k_{pd}}) \cdot \cos(\delta_{fd}) \qquad \text{Nominal passive pressure at } y_2$$

$$R_{ep} := \frac{r_{ep1} + r_{ep2}}{2} \cdot (y_2 - y_1) \qquad R_{ep} = 0 \frac{\text{lb}}{\text{ft}} \qquad \text{Nominal passive resistance Drained Conditions}$$

416 Note: Passive Resistance shall be neglected in stability computations, unless the base of the wall extends below the depth of maximum scour, freeze-thaw or other disturbances. In the latter case, only the embedment below the greater of these depths shall be considered effective LRFD [11.6.3.5].

Compute sliding resistance between soil and foundation:

$$c := 1.0$$

c = 1.0 for Cast-in-Place
c = 0.8 for Precast

$$\Sigma V := V_{Ia} \qquad \Sigma V = 16277.6 \frac{\text{lb}}{\text{ft}} \qquad \text{Sum of Vertical Loads (Strength Ia)}$$

$$R_\tau := c \cdot \Sigma V \cdot \tan(\phi'_{fd}) \qquad R_\tau = 6576.6 \frac{\text{lb}}{\text{ft}} \qquad \text{Nominal sliding resistance Cohesionless Soils}$$

Compute factored resistance against failure by sliding LRFD [10.6.3.4]:

$$\phi_{ep} := 0.5$$

Resistance factor for passive resistance specified in LRFD Table 10.5.5.2.2-1

$$\phi_\tau := 1.0$$

Resistance factor for sliding resistance specified in LRFD Table 11.5.7-1.

$$\phi R_n := \phi_\tau \cdot R_\tau + \phi_{ep} \cdot R_{ep}$$

$$R_R := \phi R_n$$

Factored Sliding Resistance to be used in CDR Calculations:

$$R_R = 6576.572 \frac{\text{lb}}{\text{ft}}$$

Sliding Capacity:Demand Ratio (CDR)

$$CDR_{Sliding} := \frac{R_R}{R_u}$$

Is the CDR > or = to 1.0?

$$CDR_{Sliding} = 1.42$$

Undrained Conditions (Total Stress):

Compute passive resistance throughout the design life of the wall LRFD [Eq 3.11.5.4-1]:

$$r_{ep1} := (k_{pu} \cdot \gamma_{fd} \cdot y_1 + 2 \cdot Su_{fd} \cdot \sqrt{k_{pu}}) \cdot \cos(\delta_{fd})$$

Nominal passive pressure at y1

$$r_{ep2} := (k_{pu} \cdot \gamma_{fd} \cdot y_2 + 2 \cdot Su_{fd} \cdot \sqrt{k_{pu}}) \cdot \cos(\delta_{fd})$$

Nominal passive pressure at y2

$$R_{ep} := \frac{r_{ep1} + r_{ep2}}{2} \cdot (y_2 - y_1) \quad R_{ep} = 0 \frac{lbf}{ft}$$

Nominal passive resistance Drained Conditions

416 Note: Passive Resistance shall be neglected in stability computations, unless the base of the wall extends below the depth of maximum scour, freeze-thaw or other disturbances. In the latter case, only the embedment below the greater of these depths shall be considered effective LRFD [11.6.3.5].

Compute sliding resistance between soil and foundation:

$$c := 1.0$$

c = 1.0 for Cast-in-Place
c = 0.8 for Precast

$$\Sigma V := V_{Ia} \quad \Sigma V = 16277.6 \frac{lbf}{ft}$$

Sum of Vertical Loads (Strength Ia)

$$e = 0 \text{ ft}$$

Wall eccentricity, Calculated in above Limiting Eccentricity at Base of Wall (Strength Ia) Section.

$$B = 11 \text{ ft}$$

Footing base width

$$\frac{B}{6} = 1.8 \text{ ft}$$

If e < B/6 the resultant is in the middle one-third

$$\sigma_{vmax} := \frac{\Sigma V}{B} \cdot \left(1 + 6 \cdot \frac{e}{B}\right) \quad \sigma_{vmax} = 1481.3 \frac{lbf}{ft^2}$$

Max vertical stress (if resultant is in the middle one-third of base) LRFD [11.6.3.2-2].

$$\sigma_{vmin} := \frac{\Sigma V}{B} \cdot \left(1 - 6 \cdot \frac{e}{B}\right) \quad \sigma_{vmin} = 1478.3 \frac{lbf}{ft^2}$$

Max vertical stress (if resultant is in the middle one-third of base) LRFD [11.6.3.2-2].

$$q_{max} := \frac{1}{2} \cdot \sigma_{vmax} \quad q_{max} = 740.7 \frac{lbf}{ft^2}$$

Max unit shear resistance as 1/2 max vertical stress LRFD [10.6.3.4].

$$q_{min} := \frac{1}{2} \cdot \sigma_{vmin} \quad q_{min} = 739.1 \frac{lbf}{ft^2}$$

Minimum unit shear resistance as 1/2 minimum vertical stress LRFD [10.6.3.4].

Determine which Cohesive Soil Resistance Case is Present:

$$Case_1 := \text{if}(q_{max} > Su_{fd} > q_{min} \geq 0, 1, 0) \quad Case_1 = 0$$

$$Case_2 := \text{if}(Su_{fd} > q_{max} > q_{min} \geq 0, 1, 0) \quad Case_2 = 1$$

$$Case_3 := \text{if}(q_{max} > q_{min} > Su_{fd}, 1, 0) \quad Case_3 = 0$$

$$Case_4 := \text{if}(q_{min} < 0, \text{if}(Su_{fd} < q_{max}, 1, 0), 0) \quad Case_4 = 0$$

$$Case_5 := \text{if}(q_{min} < 0, \text{if}(Su_{fd} > q_{max}, 1, 0), 0) \quad Case_5 = 0$$

Unit Shear Resistance for Case 1:

$$S_1 := Su_{fdu} - q_{min} = 1360.9 \frac{lbf}{ft^2}$$

$$B_1 := \frac{B \cdot (Su_{fdu} - q_{min})}{q_{max} - q_{min}} = 9789 \text{ ft}$$

$$B_3 := B = 11 \text{ ft}$$

$$I := \frac{1}{2} \cdot S_1 \cdot B_1 = 6660808.8 \frac{lbf}{ft}$$

$$III := S_2 \cdot B_3 = 8130.4 \frac{lbf}{ft}$$

$$R_{\tau_{case1}} := I + II + III = -6637708.8 \frac{lbf}{ft}$$

$$S_2 := q_{min} = 739.1 \frac{lbf}{ft^2}$$

$$B_2 := \frac{B \cdot (q_{max} - Su_{fdu})}{q_{max} - q_{min}} = -9778 \text{ ft}$$

$$II := S_1 \cdot B_2 = -13306648.1 \frac{lbf}{ft}$$

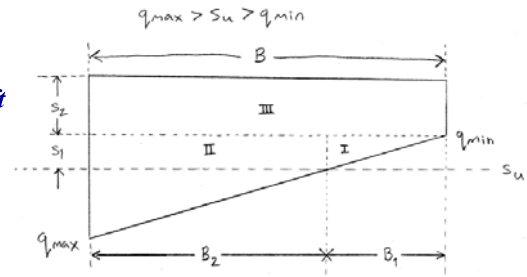

Unit Shear Resistance for Case 2:

$$S_1 := q_{max} - q_{min} = 1.5 \frac{lbf}{ft^2}$$

$$B = 11 \text{ ft}$$

$$I := \frac{1}{2} \cdot S_1 \cdot B = 8.4 \frac{lbf}{ft}$$

$$R_{\tau_{case2}} := I + II = 8138.8 \frac{lbf}{ft}$$

$$S_2 := q_{min} = 739.1 \frac{lbf}{ft^2}$$

$$II := S_2 \cdot B = 8130.4 \frac{lbf}{ft}$$

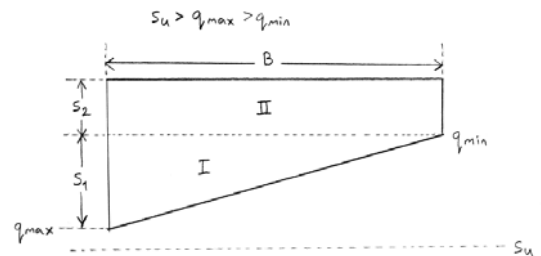

Unit Shear Resistance for Case 3:

$$S_1 := Su_{fdu} = 2100 \frac{lbf}{ft^2}$$

$$B = 11 \text{ ft}$$

$$I := \frac{1}{2} \cdot S_1 \cdot B = 11550 \frac{lbf}{ft}$$

$$R_{\tau_{case3}} := I = 11550 \frac{lbf}{ft}$$

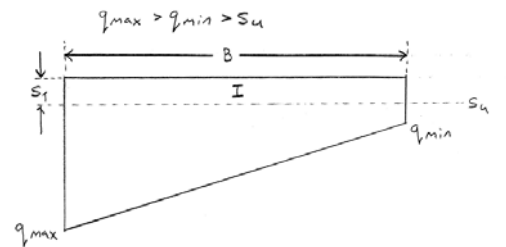

Unit Shear Resistance for Case 4:

$$S_1 := Su_{fdu} = 2100 \frac{lbf}{ft^2}$$

$$B_3 := \frac{B \cdot (-q_{min})}{q_{max} - q_{min}} = -5316.7 \text{ ft}$$

$$B_2 := B - (B_1 + B_3) = -9778 \text{ ft}$$

$$I := \frac{1}{2} \cdot S_1 \cdot B_1 = 15860961.7 \frac{lbf}{ft}$$

$$R_{\tau_{case4}} := I + II = -4672867.4 \frac{lbf}{ft}$$

$$B_1 := \left(\frac{Su_{fdu}}{q_{max}} \right) \cdot (B - B_3) = 15105.7 \text{ ft}$$

$$II := S_1 \cdot B_2 = -20533829.1 \frac{lbf}{ft}$$

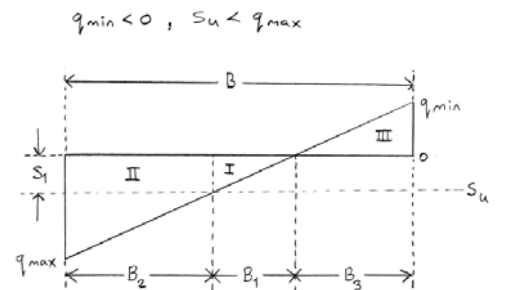

Unit Shear Resistance for Case 5:

$$S_1 := q_{max} = 740.7 \frac{\text{lb}}{\text{ft}^2}$$

$$B_1 := \frac{B \cdot q_{max}}{q_{max} - q_{min}} = 5327.7 \text{ ft}$$

$$I := \frac{1}{2} \cdot S_1 \cdot B_1 = 1972980.2 \frac{\text{lb}}{\text{ft}}$$

$$R_{\tau_{case5}} := I = 1972980.2 \frac{\text{lb}}{\text{ft}}$$

$$B_2 := B - B_1 = -5316.7 \text{ ft}$$

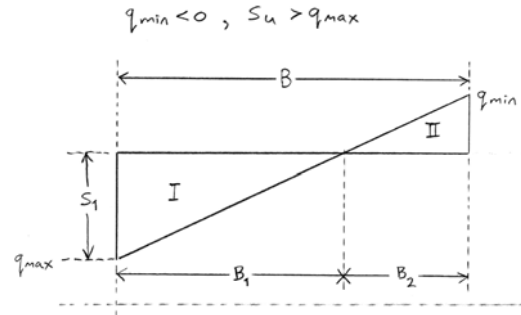

Define the Applicable Case:

$$R_{\tau} := R_{\tau_{case2}}$$

$$R_{\tau} = 8138.8 \frac{\text{lb}}{\text{ft}}$$

Nominal sliding resistance Cohesive Soils

Compute factored resistance against failure by sliding **LRFD [10.6.3.4]:**

$$\phi_{ep} := 0.5$$

Resistance factor for passive resistance specified in **LRFD Table 10.5.5.2.2-1**

$$\phi_{\tau} := 1.0$$

Resistance factor for sliding resistance specified in **LRFD Table 11.5.7-1.**

$$\phi R_n := \phi_{\tau} \cdot R_{\tau} + \phi_{ep} \cdot R_{ep}$$

$$R_R := \phi R_n$$

Factored Sliding Resistance to be used in CDR Calculations:

$$R_R = 8138.793 \frac{\text{lb}}{\text{ft}}$$

Sliding Capacity: Demand Ratio (CDR)

$$CDR_{Sliding} := \frac{R_R}{R_u}$$

Is the CDR > or = to 1.0?

$$CDR_{Sliding} = 1.75$$

RETAINING WALL 5

Objective: To evaluate the external stability of CIP wall's with level backfill (no backslope).
Method: In accordance with ODOT Bridge Design Manual, 2024 [Sect. 307] LRFD Bridge Design Specifications, 8th Ed., Nov. 2017, [Sect. 11.6.1, Sect. 11.6.2, and Sect. 11.6.3].

Givens:

Backfill Soil Design Parameters:

$$\phi'_f := 30 \text{ deg}$$

Effective angle of internal friction

$$\gamma_f := 120 \frac{\text{lb}}{\text{ft}^3}$$

Unit weight

$$c'_f := 0 \frac{\text{lb}}{\text{ft}^2}$$

Effective Cohesion

$$\delta := 0.67 \cdot \phi'_f$$

$$\delta = 20.1 \text{ deg}$$

Friction angle between backfill and wall taken as specified in **LRFD BDS C3.11.5.3 (degrees)**

Foundation Soil Design Parameters:

Drained Conditions (Effective Stress):

$$\phi'_{fd} := 22 \text{ deg}$$

Effective angle of internal friction

$$\gamma_{fd} := 125 \frac{\text{lb}}{\text{ft}^3}$$

Unit weight

$$c'_{fd} := 205 \frac{\text{lb}}{\text{ft}^2}$$

Effective Cohesion

$$\delta_{fd} := 0.67 \cdot \phi'_{fd}$$

$$\delta_{fd} = 14.7 \text{ deg}$$

Friction angle between foundation soils and footing taken as specified in **LRFD BDS C3.11.5.3 (degrees)**

Undrained Conditions (Total Stress):

$$\phi_{fdu} := 0 \text{ deg}$$

Angle of internal friction (Same as Drained Conditions if granular soils)

$$\gamma_{fd} = 125 \frac{\text{lb}}{\text{ft}^3}$$

Unit weight

$$Su_{fdu} := 2100 \frac{\text{lb}}{\text{ft}^2}$$

Undrained Shear Strength

$$\delta_{fdu} := 0.67 \cdot \phi_{fdu}$$

$$\delta_{fdu} = 0 \text{ deg}$$

Friction angle between foundation soils and footing taken as specified in **LRFD BDS C3.11.5.3 (degrees)**

Foundation Surcharge Soil Parameters:

$$\gamma_q := 120 \frac{\text{lb}}{\text{ft}^3}$$

Unit weight of Soil above bearing depth (Used in Bearing Resistance of Soil Calculation **LRFD 10.6.3.1.2a-1**)

Other Parameters:

$$\gamma_c := 150 \frac{\text{lb}}{\text{ft}^3}$$

Concrete Unit weight

$$\gamma_p := 150 \frac{\text{lb}}{\text{ft}^3}$$

Pavement Unit weight

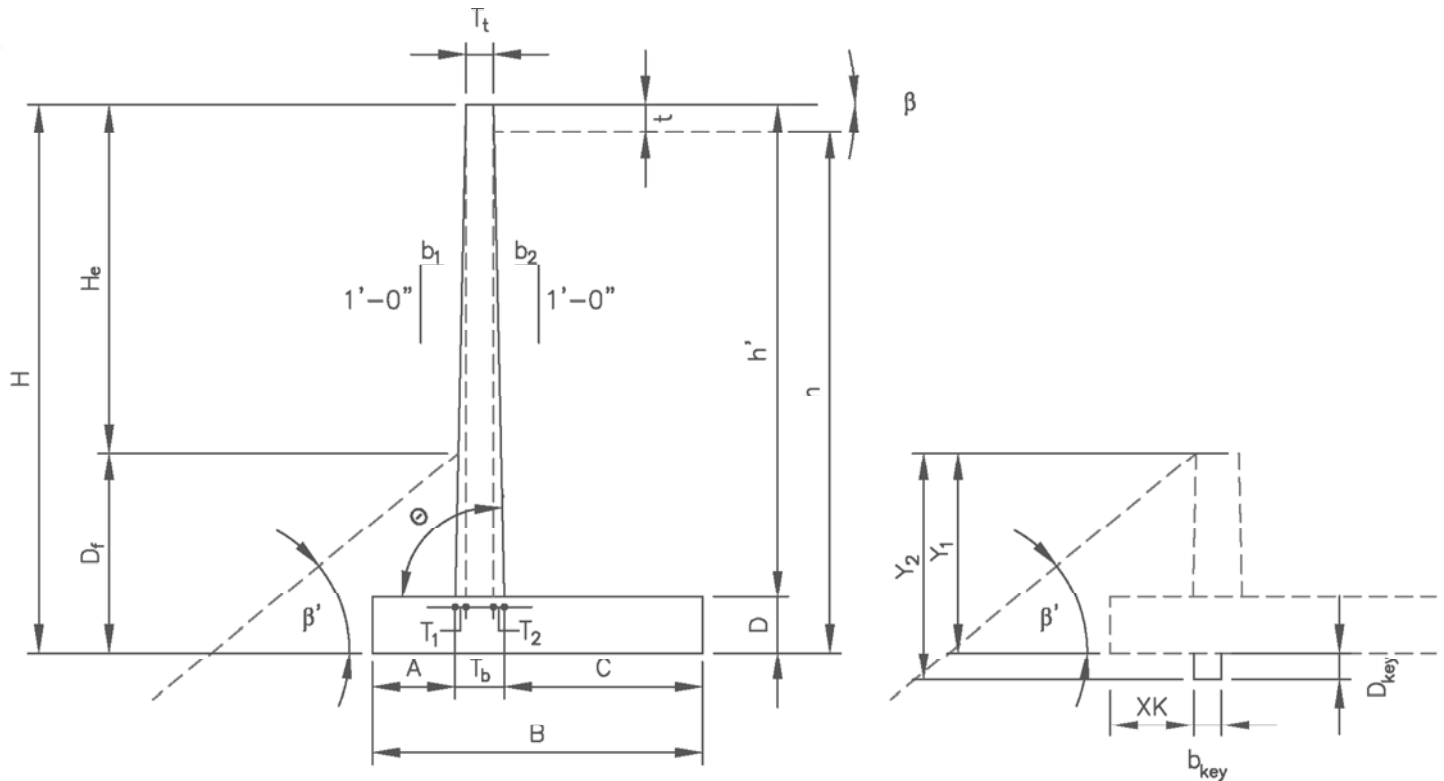

Wall Geometry:

$H_e := 9.15 \text{ ft}$

$D_f := 3.5 \text{ ft}$

$H := H_e + D_f$

$H = 12.7 \text{ ft}$

$T_t := 1 \text{ ft}$

$b_1 := 1.50 \cdot \left(\frac{\text{in}}{\text{ft}}\right)$

$b_2 := 0 \cdot \left(\frac{\text{in}}{\text{ft}}\right)$

$\beta := 0 \text{ deg}$

$\beta' := 0 \text{ deg}$

$t := 0.5 \cdot \text{ft}$

- Inclination of ground slope:
- Horizontal: **0**
 - 3H:1V: **18.435**
 - 2H:1V: **26.565**
 - 1.5H:1V: **33.690**

Exposed wall height

Footing cover at Toe

Note: Where the potential for scour, erosion of undermining exists, spread footings shall be located to bear below the maximum depth of scour or undermining. Spread footings shall be located below the depth of potential frost. **LRFD BDS 10.6.1.2.**

Design Wall Height

Stem thickness at top of wall

Frontwall batter, (b1H:12V)

Backwall batter, (b2H:12V)

Inclination of ground slope behind face of wall.
Horizontal backfill behind CIP wall, $\beta = 0 \text{ deg}$

Inclination of ground slope in front of wall. If it is horizontal backfill in front of CIP wall, $\beta' = 0 \text{ deg}$. A negative angle (-) indicates grades slope up from front of wall. Positive angle (+) indicates grade slope down from wall as shown in above figure.

Pavement thickness

Preliminary Wall Dimensioning:

$B := 9 \text{ ft}$	$\frac{2}{5} \cdot H = 5.06 \text{ ft}$ to $\frac{3}{5} \cdot H = 7.59 \text{ ft}$	Footing base width (2/5H to 3/5H)
$A := 1.5 \text{ ft}$	$\frac{H}{8} = 1.58 \text{ ft}$ to $\frac{H}{5} = 2.53 \text{ ft}$	Toe projection (H/8 to H/5)
$D := 2 \text{ ft}$	$\frac{H}{8} = 1.58 \text{ ft}$ to $\frac{H}{5} = 2.53 \text{ ft}$	Footing thickness (H/8 to H/5)

Shear Key Dimensioning:

$D_{key} := 0 \text{ ft}$	Depth of shear key from bottom of footing Note: Footings on rock typically require shear key
$b_{key} := 0 \text{ ft}$	Width of shear key
$XK := A$	Distance from toe to shear key

Other Wall Dimensions:

$h' := H - D$	$h' = 10.7 \text{ ft}$	Stem height
$T_1 := b_1 \cdot h'$	$T_1 = 1.331 \text{ ft}$	Stem front batter width
$T_2 := b_2 \cdot h'$	$T_2 = 0 \text{ ft}$	Stem back batter width
$T_b := T_1 + T_2 + T_t$	$T_b = 2.331 \text{ ft}$	Stem thickness at bottom of wall
$C := B - A - T_b$	$C = 5.169 \text{ ft}$	Heel projection
$\theta := 90 \text{ deg}$		Angle of back face of wall to horizontal = $atan(12/b_2)$
$b := 12 \text{ in}$	$b = 1 \text{ ft}$	Concrete strip width (for design)
$y_1 := 3.5 \cdot \text{ft}$	$y_1 = 3.5 \text{ ft}$	Depth to where passive pressure may begin to be utilized in front of wall. (Typically Df)
$y_2 := D_f + D_{key}$	$y_2 = 3.5 \text{ ft}$	Bottom of shear key/footing depth i.e. depth to where passive pressure may no longer be utilized.
$h := H - t$	$h = 12.2 \text{ ft}$	Height of retained fill at back of heel

Live Load Surcharge Parameters:

$\lambda := 20 \text{ ft}$	Horizontal distance from the back of the wall to point of traffic surcharge load
$SUR := \text{if} \left(\lambda < \frac{H}{2}, 250 \frac{\text{lb}}{\text{ft}^2}, 100 \frac{\text{lb}}{\text{ft}^2} \right) = 100 \frac{\text{lb}}{\text{ft}^2}$	Live load surcharge (per LRFD BDS [3.11.6.4]) Note: If vehicular loading is within 1 ft of the backface of the wall and with a design height, H, less than 20 ft, see LRFD BDS Section 3.11.6.4 and Table 3.11.6.4-2 for adjusted surcharge load calculation. Note: when $\lambda < H/2$, SUR equal 100 psf to account for construction loads

Calculations:

Earth Pressure Coefficients:

Backfill Active Earth:

$$\Gamma := \left(1 + \sqrt{\frac{(\sin(\phi'_f + \delta) \cdot \sin(\phi'_f - \beta))}{(\sin(\theta - \delta) \cdot \sin(\theta + \beta))}} \right)^2 \quad \Gamma = 2.687$$

$$k_{af} := \left(\frac{(\sin(\theta + \phi'_f))^2}{(\Gamma \cdot (\sin(\theta))^2 \cdot \sin(\theta - \delta))} \right) \quad k_{af} = 0.297 \quad \text{Active Earth Pressure Coefficient (per LRFD Sect. 3.11.5.3)}$$

Foundation Soil Passive Earth:

Drained Conditions assuming ($\phi'_{fd} > 0$):

Input Parameters for **LRFD Figure 3.11.5.4-2**, assumes $\theta = 90$ degrees

$$\frac{-\beta'}{\phi'_{fd}} = 0$$

$$\frac{-\delta_{fd}}{\phi'_{fd}} = -0.67$$

$$k'_p := 3.54$$

Passive Earth Pressure Coefficient from **LRFD Figure 3.11.5.4-2**

Determine Reduction Factor (R) by interpolation:

$$R_d := 0.828$$

Reduction Factor

$$k_{pd} := R_d \cdot k'_p \quad k_{pd} = 2.931$$

Passive Earth Pressure Coefficient for Drained Conditions

Undrained Conditions ($\phi'_{fdu} > 0$): **Note:** Expand window below to complete calculation

Undrained Conditions:

$$k_{pu} := \text{if}(\phi'_{fdu} > 0, k_{pu}, 1) \quad k_{pu} = 1$$

Passive Earth Pressure Coefficient for Resistance Undrained Conditions

Compute Unfactored Loads LRFD [Tables 3.4.1-1 and 3.4.1-2]:

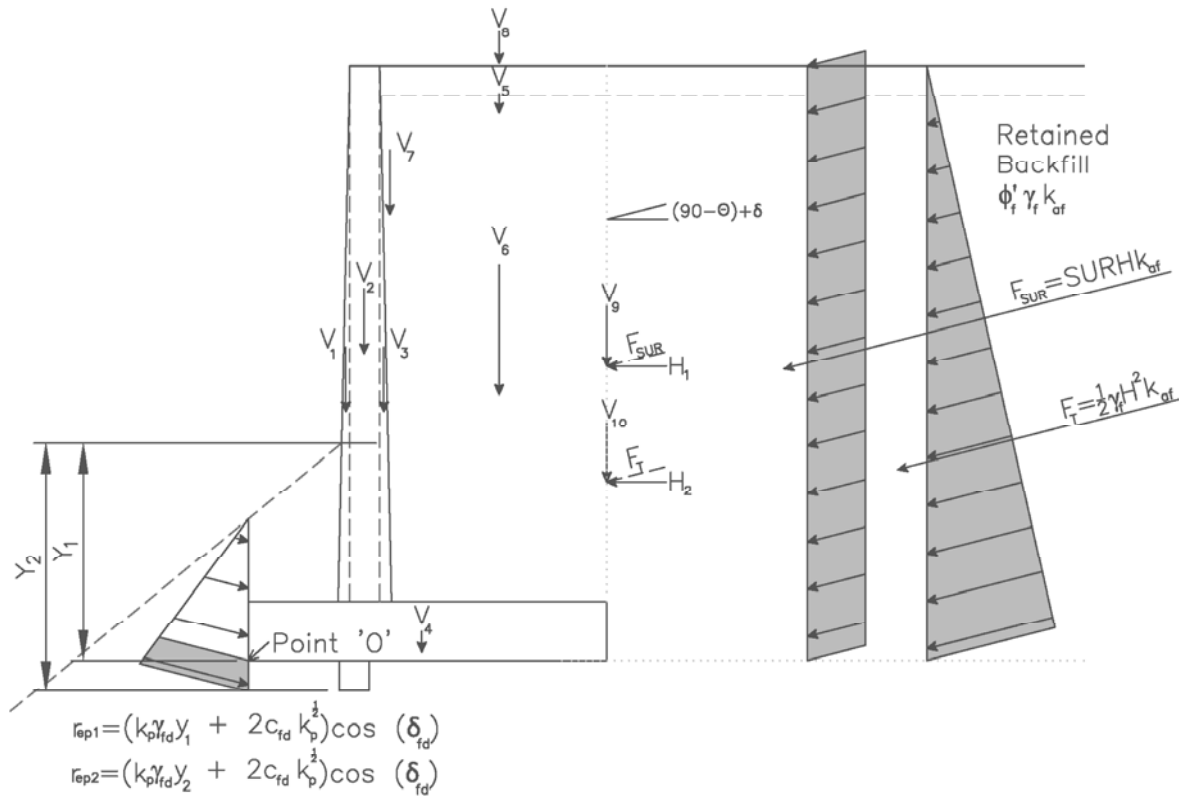

$$F_T := \frac{1}{2} \cdot \gamma_f \cdot H^2 \cdot k_{af}$$

$$F_{SUR} := SUR \cdot H \cdot k_{af}$$

Vertical Loads:

$$V_1 := \frac{1}{2} \cdot T_1 \cdot h' \cdot \gamma_c$$

$$V_2 := T_t \cdot h' \cdot \gamma_c$$

$$V_3 := \frac{1}{2} \cdot T_2 \cdot h' \cdot \gamma_c$$

$$V_4 := D \cdot B \cdot \gamma_c$$

$$V_5 := t \cdot (T_2 + C) \cdot \gamma_p$$

$$V_6 := C \cdot (h' - t) \cdot \gamma_f$$

$$V_7 := \frac{1}{2} \cdot b_2 \cdot (h' - t)^2 \cdot \gamma_f$$

$$V_8 := SUR \cdot (T_2 + C)$$

$$V_9 := F_{SUR} \cdot \sin(90 \cdot \text{deg} - \theta + \delta)$$

$$V_{10} := F_T \cdot \sin(90 \cdot \text{deg} - \theta + \delta)$$

$$F_T = 2854.1 \frac{\text{lbf}}{\text{ft}}$$

$$F_{SUR} = 376 \frac{\text{lbf}}{\text{ft}}$$

$$V_1 = 1063.3 \frac{\text{lbf}}{\text{ft}}$$

$$V_2 = 1597.5 \frac{\text{lbf}}{\text{ft}}$$

$$V_3 = 0 \frac{\text{lbf}}{\text{ft}}$$

$$V_4 = 2700 \frac{\text{lbf}}{\text{ft}}$$

$$V_5 = 387.7 \frac{\text{lbf}}{\text{ft}}$$

$$V_6 = 6295.5 \frac{\text{lbf}}{\text{ft}}$$

$$V_7 = 0 \frac{\text{lbf}}{\text{ft}}$$

$$V_8 = 516.9 \frac{\text{lbf}}{\text{ft}}$$

$$V_9 = 129.2 \frac{\text{lbf}}{\text{ft}}$$

$$V_{10} = 980.8 \frac{\text{lbf}}{\text{ft}}$$

Active Earth Force Resultant (EH)

Live Load Surcharge (LS)

Wall stem front batter (DC)

Wall stem (DC)

Wall stem back batter (DC)

Wall Footing (DC)

Pavement (DC)

Soil Backfill - Heel (EV)

Soil Backfill - Batter (EV)

Live Load Surcharge above Heel- (LS)
- Strength lb

Live Load Surcharge Resultant (vertical
comp. - LS) - Strength la

Active earth force resultant (vertical
component - EH)

Moment Arm:

Moments produced from vertical loads about Point 'O'

$$d_{v1} := A + \frac{2}{3} \cdot T_1 = 2.4 \text{ ft}$$

$$d_{v2} := A + T_1 + \frac{T_1}{2} = 3.3 \text{ ft}$$

$$d_{v3} := A + T_1 + T_1 + \frac{T_2}{3} = 3.8 \text{ ft}$$

$$d_{v4} := \frac{B}{2} = 4.5 \text{ ft}$$

$$d_{v5} := B - \frac{T_2 + C}{2} = 6.4 \text{ ft}$$

$$d_{v6} := B - \frac{C}{2} = 6.4 \text{ ft}$$

$$d_{v7} := A + T_1 + T_1 + \left(\frac{2}{3} \cdot b_2 \cdot (h' - t) \right) = 3.8 \text{ ft}$$

$$d_{v8} := B - \frac{T_2 + C}{2} = 6.4 \text{ ft}$$

$$d_{v9} := B = 9 \text{ ft}$$

$$d_{v10} := B = 9 \text{ ft}$$

Moment:

$$MV_1 := V_1 \cdot d_{v1} = 2538.7 \text{ lbf}$$

$$MV_2 := V_2 \cdot d_{v2} = 5321.7 \text{ lbf}$$

$$MV_3 := V_3 \cdot d_{v3} = 0 \text{ lbf}$$

$$MV_4 := V_4 \cdot d_{v4} = 12150 \text{ lbf}$$

$$MV_5 := V_5 \cdot d_{v5} = 2487.1 \text{ lbf}$$

$$MV_6 := V_6 \cdot d_{v6} = 40389.8 \text{ lbf}$$

$$MV_7 := V_7 \cdot d_{v7} = 0 \text{ lbf}$$

$$MV_8 := V_8 \cdot d_{v8} = 3316.1 \text{ lbf}$$

$$MV_9 := V_9 \cdot d_{v9} = 1163 \text{ lbf}$$

$$MV_{10} := V_{10} \cdot d_{v10} = 8827.5 \text{ lbf}$$

Horizontal Loads:

$$H_1 := F_{SUR} \cdot \cos(90 \cdot \text{deg} - \theta + \delta) \quad H_1 = 353.1 \frac{\text{lbf}}{\text{ft}}$$

$$H_2 := F_T \cdot \cos(90 \cdot \text{deg} - \theta + \delta) \quad H_2 = 2680.3 \frac{\text{lbf}}{\text{ft}}$$

Live Load Surcharge Resultant (horizontal comp. - LS)

Active Earth Force Resultant (horizontal comp. - EH)

Moment Arm:

$$d_{h1} := \frac{H}{2} \quad d_{h1} = 6.3 \text{ ft}$$

$$d_{h2} := \frac{H}{3} \quad d_{h2} = 4.2 \text{ ft}$$

Moment:

$$MH_1 := H_1 \cdot d_{h1} \quad MH_1 = 2233.6 \frac{\text{lbf} \cdot \text{ft}}{\text{ft}}$$

$$MH_2 := H_2 \cdot d_{h2} \quad MH_2 = 11301.8 \frac{\text{lbf} \cdot \text{ft}}{\text{ft}}$$

Unfactored Loads by Load Type:

$$V_{DC} := V_1 + V_2 + V_3 + V_4 + V_5 \quad V_{DC} = 5748.5 \frac{\text{lbf}}{\text{ft}}$$

$$V_{LS_Ia} := V_9 \quad V_{LS_Ia} = 129.2 \frac{\text{lbf}}{\text{ft}}$$

$$V_{EH} := V_{10} \quad V_{EH} = 980.8 \frac{\text{lbf}}{\text{ft}}$$

$$H_{EH} := H_2 \quad H_{EH} = 2680.3 \frac{\text{lbf}}{\text{ft}}$$

$$V_{EV} := V_6 + V_7 \quad V_{EV} = 6295.5 \frac{\text{lbf}}{\text{ft}}$$

$$V_{LS_Ib} := V_8 + V_9 \quad V_{LS_Ib} = 646.1 \frac{\text{lbf}}{\text{ft}}$$

$$H_{LS} := H_1 \quad H_{LS} = 353.1 \frac{\text{lbf}}{\text{ft}}$$

Unfactored Moments by Load Type

$M_{DC} := MV_1 + MV_2 + MV_3 + MV_4 + MV_5$	$M_{DC} = 22497.4 \frac{\text{lb}\cdot\text{ft}}{\text{ft}}$
$M_{EV} := MV_6 + MV_7$	$M_{EV} = 40389.8 \frac{\text{lb}\cdot\text{ft}}{\text{ft}}$
$M_{LSV_Ia} := MV_9$	$M_{LSV_Ia} = 1163 \frac{\text{lb}\cdot\text{ft}}{\text{ft}}$
$M_{LSV_Ib} := MV_8 + MV_9$	$M_{LSV_Ib} = 4479.1 \frac{\text{lb}\cdot\text{ft}}{\text{ft}}$
$M_{EH1} := MV_{10}$	$M_{EH1} = 8827.5 \frac{\text{lb}\cdot\text{ft}}{\text{ft}}$
$M_{LSH} := MH_1$	$M_{LSH} = 2233.6 \frac{\text{lb}\cdot\text{ft}}{\text{ft}}$
$M_{EH2} := MH_2$	$M_{EH2} = 11301.8 \frac{\text{lb}\cdot\text{ft}}{\text{ft}}$

Load Combination Limit States:

$\eta := 1$ LRFD Load Modifier
 Strength Limit State I: EV(min) = 1.00 EV(max) = 1.35
 EH(min) = 0.90 EH(max) = 1.50
 LS = 1.75

Strength Limit State Ia: (Sliding and Eccentricity)	$Ia_{DC} := 0.9$	$Ia_{EV} := 1$	$Ia_{EH} := 1.5$	$Ia_{LS} := 1.75$
Strength Limit State Ib: (Bearing Capacity)	$Ib_{DC} := 1.25$	$Ib_{EV} := 1.35$	$Ib_{EH} := 1.5$	$Ib_{LS} := 1.75$

Factored Vertical Loads by Limit State:

$V_{Ia} := \eta \cdot ((Ia_{DC} \cdot V_{DC}) + (Ia_{EV} \cdot V_{EV}) + (Ia_{EH} \cdot V_{EH}) + (Ia_{LS} \cdot V_{LS_Ia}))$	$V_{Ia} = 13166.6 \frac{\text{lb}}{\text{ft}}$
$V_{Ib} := \eta \cdot ((Ib_{DC} \cdot V_{DC}) + (Ib_{EV} \cdot V_{EV}) + (Ib_{EH} \cdot V_{EH}) + (Ib_{LS} \cdot V_{LS_Ib}))$	$V_{Ib} = 18286.5 \frac{\text{lb}}{\text{ft}}$

Factored Horizontal Loads by Limit State:

$H_{Ia} := \eta \cdot ((Ia_{LS} \cdot H_{LS}) + (Ia_{EH} \cdot H_{EH}))$	$H_{Ia} = 4638.4 \frac{\text{lb}}{\text{ft}}$
$H_{Ib} := \eta \cdot ((Ib_{LS} \cdot H_{LS}) + (Ib_{EH} \cdot H_{EH}))$	$H_{Ib} = 4638.4 \frac{\text{lb}}{\text{ft}}$

Factored Moments Produced by Vertical Loads by Limit State:

$MV_{Ia} := \eta \cdot ((Ia_{DC} \cdot M_{DC}) + (Ia_{EV} \cdot M_{EV}) + (Ia_{EH} \cdot M_{EH1}) + (Ia_{LS} \cdot M_{LSV_Ia}))$	$MV_{Ia} = 75914.2 \frac{\text{lb}\cdot\text{ft}}{\text{ft}}$
$MV_{Ib} := \eta \cdot ((Ib_{DC} \cdot M_{DC}) + (Ib_{EV} \cdot M_{EV}) + (Ib_{EH} \cdot M_{EH1}) + (Ib_{LS} \cdot M_{LSV_Ib}))$	$MV_{Ib} = 103727.8 \frac{\text{lb}\cdot\text{ft}}{\text{ft}}$

Factored Moments Produced by Horizontal Loads by Limit State:

$MH_{Ia} := \eta \cdot ((Ia_{LS} \cdot M_{LSH}) + (Ia_{EH} \cdot M_{EH2}))$	$MH_{Ia} = 20861.4 \frac{\text{lb}\cdot\text{ft}}{\text{ft}}$
$MH_{Ib} := \eta \cdot ((Ib_{LS} \cdot M_{LSH}) + (Ib_{EH} \cdot M_{EH2}))$	$MH_{Ib} = 20861.4 \frac{\text{lb}\cdot\text{ft}}{\text{ft}}$

Compute Bearing Resistance:

Compute the resultant location about the toe of the base length (distance from "O") Strength lb:

$\Sigma M_R := MV_{lb}$	$\Sigma M_R = 103727.8 \frac{lb \cdot ft}{ft}$	Sum of Resisting Moments (Strength lb)
$\Sigma M_O := MH_{lb}$	$\Sigma M_O = 20861.4 \frac{lb \cdot ft}{ft}$	Sum of Overturning Moments (Strength lb)
$\Sigma V := V_{lb}$	$\Sigma V = 18286.5 \frac{lb}{ft}$	Sum of Vertical Loads (Strength lb)
$x := \frac{(\Sigma M_R - \Sigma M_O)}{\Sigma V}$	$x = 4.5 \text{ ft}$	Distance from Point "O" the resultant intersects the base

$e := \left \frac{B}{2} - x \right $	$e = 0.03 \text{ ft}$	Wall eccentricity, Note: The vertical stress is assumed to be uniformly distributed over the effective bearing width, B', since the wall is supported by a soil foundation LRFD [11.6.3.2] . The effective bearing width is equal to B-2e. When the foundation eccentricity is negative the absolute value is used.
---------------------------------------	-----------------------	---

Foundation Layout:

$B' := B - 2 \cdot e$	$B' = 8.9 \text{ ft}$	Effective Footing Width
$L' := 91 \text{ ft}$		Effective Footing Length (Assumed)
$H' := H_{lb}$	$H' = 4638.4 \frac{lb}{ft}$	Summation of Horizontal Loads (Strength lb)
$V' := V_{lb}$	$V' = 18286.5 \frac{lb}{ft}$	Summation of Vertical Loads (Strength lb)
$D_f = 3.5 \text{ ft}$		Footing embedment
$d_w := 0 \text{ ft}$		Depth of Groundwater below ground surface at front of wall.

Drained Conditions (Effective Stress):

$N_q := \text{if} \left(\phi'_{fd} > 0, e^{\pi \cdot \tan(\phi'_{fd})} \cdot \tan \left(45 \text{ deg} + \frac{\phi'_{fd}}{2} \right), 1.0 \right)$	$N_q = 7.82$
$N_c := \text{if} \left(\phi'_{fd} > 0, \frac{N_q - 1}{\tan(\phi'_{fd})}, 5.14 \right)$	$N_c = 16.88$
$N_\gamma := 2 \cdot (N_q + 1) \cdot \tan(\phi'_{fd})$	$N_\gamma = 7.1$

Compute shape correction factors per LRFD [Table 10.6.3.1.2a-3]:

$s_c := \text{if} \left(\phi'_{fd} > 0, 1 + \left(\frac{B'}{L'} \right) \cdot \left(\frac{N_q}{N_c} \right), 1 + \left(\frac{B'}{5 \cdot L'} \right) \right)$	$s_c = 1.045$
$s_q := \text{if} \left(\phi'_{fd} > 0, 1 + \left(\frac{B'}{L'} \cdot \tan(\phi'_{fd}) \right), 1 \right)$	$s_q = 1.04$
$s_\gamma := \text{if} \left(\phi'_{fd} > 0, 1 - 0.4 \cdot \left(\frac{B'}{L'} \right), 1 \right)$	$s_\gamma = 0.961$

Load inclination factors:

$$i_q := 1$$

$$i_\gamma := 1$$

$$i_c := 1$$

Assumed to be 1.0, see **LRFD BDS C10.6.3.1.2a**.
"Most geotechnical engineers do not use the load inclination factors". If desired, use LRFD Equations [10.6.3.1.2a-5] thru [10.6.3.1.2a-9].

Compute groundwater depth correction factors per LRFD [Table 10.6.3.1.2a-2]:

$$C_{wq} := \text{if}(d_w \geq D_f, 1.0, 0.5) \quad C_{wq} = 0.5$$

$$C_{w\gamma} := \text{if}(d_w \geq (1.5 \cdot B) + D_f, 1.0, 0.5) \quad C_{w\gamma} = 0.5$$

Depth Correction Factor per Hanson (1970):

$$d_q := \text{if}\left(\frac{D_f}{B} \leq 1, 1 + 2 \cdot \tan(\phi'_{fd}) \cdot (1 - \sin(\phi'_{fd}))^2 \cdot \frac{D_f}{B}, 1 + 2 \cdot \tan(\phi'_{fd}) \cdot (1 - \sin(\phi'_{fd}))^2 \cdot \text{atan}\left(\frac{D_f}{B}\right)\right)$$

$$d_q = 1.12$$

Compute modified bearing capacity factors LRFD [Equation 10.6.3.1.2a-2 to 10.6.3.1.2a-4]:

$$N_{cm} := N_c \cdot s_c \cdot i_c \quad N_{cm} = 17.651$$

$$N_{qm} := N_q \cdot s_q \cdot i_q \quad N_{qm} = 8.131$$

$$N_{\gamma m} := N_\gamma \cdot s_\gamma \cdot i_\gamma \quad N_{\gamma m} = 6.848$$

Compute nominal bearing resistance. LRFD [Eq 10.6.3.1.2a-1]:

$$q_{nd} := c'_{fd} \cdot N_{cm} + \gamma_{fd} \cdot D_f \cdot N_{qm} \cdot d_q \cdot C_{wq} + 0.5 \cdot \gamma_{fd} \cdot B' \cdot N_{\gamma m} \cdot C_{w\gamma} \quad q_{nd} = 7528.3 \frac{\text{lb}}{\text{ft}^2}$$

Compute factored bearing resistance. LRFD [Eq 10.6.3.1.1]:

$$\phi_b := 0.55$$

Bearing resistance factor LRFD Table 11.5.7-1.

$$q_{Rd} := \phi_b \cdot q_{nd} \quad q_{Rd} = 4.1 \text{ ksf}$$

Factored bearing resistance Drained Conditions

Undrained Conditions (Effective Stress):

$$N_q := \text{if}\left(\phi_{fd} > 0, e^{\pi \cdot \tan(\phi_{fd})} \cdot \tan\left(45 \text{ deg} + \frac{\phi_{fd}}{2}\right), 1.0\right) \quad N_q = 1$$

$$N_c := \text{if}\left(\phi_{fd} > 0, \frac{N_q - 1}{\tan(\phi_{fd})}, 5.14\right) \quad N_c = 5.14$$

$$N_\gamma := 2 \cdot (N_q + 1) \cdot \tan(\phi_{fd}) \quad N_\gamma = 0$$

Compute shape correction factors per LRFD [Table 10.6.3.1.2a-3]:

$$s_c := \text{if} \left(\phi_{fd_u} > 0, 1 + \left(\frac{B'}{L'} \right) \cdot \left(\frac{N_q}{N_c} \right), 1 + \left(\frac{B'}{5 \cdot L'} \right) \right) \quad s_c = 1.02$$

$$s_q := \text{if} \left(\phi_{fd_u} > 0, 1 + \left(\frac{B'}{L'} \cdot \tan(\phi_{fd_u}) \right), 1 \right) \quad s_q = 1$$

$$s_\gamma := \text{if} \left(\phi_{fd_u} > 0, 1 - 0.4 \cdot \left(\frac{B'}{L'} \right), 1 \right) \quad s_\gamma = 1$$

Load inclination factors:

$$i_q := 1$$

$$i_\gamma := 1$$

$$i_c := 1$$

Assumed to be 1.0, see LRFD BDS C10.6.3.1.2a. "Most geotechnical engineers do not use the load inclination factors". If desired, use LRFD Equations [10.6.3.1.2a-5] thru [10.6.3.1.2a-9].

Compute modified bearing capacity factors LRFD [Equation 10.6.3.1.2a-2 to 10.6.3.1.2a-4]:

$$N_{cm} := N_c \cdot s_c \cdot i_c \quad N_{cm} = 5.241$$

$$N_{qm} := N_q \cdot s_q \cdot i_q \quad N_{qm} = 1$$

$$N_{\gamma m} := N_\gamma \cdot s_\gamma \cdot i_\gamma \quad N_{\gamma m} = 0$$

Depth Correction Factor per Hanson (1970):

$$d_q := \text{if} \left(\frac{D_f}{B} \leq 1, 1 + 2 \cdot \tan(\phi_{fd_u}) \cdot (1 - \sin(\phi_{fd_u}))^2 \cdot \frac{D_f}{B}, 1 + 2 \cdot \tan(\phi_{fd_u}) \cdot (1 - \sin(\phi_{fd_u}))^2 \cdot \text{atan} \left(\frac{D_f}{B} \right) \right)$$

$$d_q = 1$$

Compute nominal bearing resistance. LRFD [Eq 10.6.3.1.2a-1]:

$$q_{nu} := Su_{fd_u} \cdot N_{cm} + \gamma_{fd} \cdot D_f \cdot N_{qm} \cdot d_q \cdot C_{wq} + 0.5 \cdot \gamma_{fd} \cdot B' \cdot N_{\gamma m} \cdot C_{w\gamma} \quad q_{nu} = 11224.8 \frac{\text{lbf}}{\text{ft}^2}$$

Compute factored bearing resistance. LRFD [Eq 10.6.3.1.1]:

$$\phi_b := 0.55$$

$$q_{Ru} := \phi_b \cdot q_{nu} \quad q_{Ru} = 6.2 \text{ ksf}$$

Bearing resistance factor LRFD Table 11.5.7-1.

Factored bearing resistance Undrained Conditions

Factored Bearing Resistance Drained vs. Undrained Conditions:

Drained Conditions: $q_{Rd} = 4.1 \text{ ksf}$

Undrained Conditions: $q_{Ru} = 6.2 \text{ ksf}$

Evaluate External Stability of Wall:

Compute the ultimate bearing stress :

$$e = 0.03 \text{ ft}$$

$$\sigma_V := \frac{\Sigma V}{B - 2 \cdot e} \quad \sigma_V = 2.046 \text{ ksf}$$

Bearing Capacity:Demand Ratio (CDR)

Drained Conditions:	$CDR_{Bearing_D} := \frac{q_{Rd}}{\sigma_V}$	Is the CDR > or = to 1.0?	$CDR_{Bearing_D} = 2.02$
---------------------	---	---------------------------	---------------------------

Undrained Conditions:	$CDR_{Bearing_U} := \frac{q_{Ru}}{\sigma_V}$	Is the CDR > or = to 1.0?	$CDR_{Bearing_U} = 3.02$
-----------------------	---	---------------------------	---------------------------

Limiting Eccentricity at Base of Wall (Strength Ia):

Compute the resultant location about the toe "O" of the base length (distance from Pivot):

$$e_{max} := \frac{B}{3}$$

$$e_{max} = 3 \text{ ft}$$

Maximum Eccentricity **LRFD [11.6.3.3.]**
Equals B/3 for soil.

$$\Sigma M_R := MV_{Ia}$$

$$\Sigma M_R = 75914.2 \frac{\text{lb} \cdot \text{ft}}{\text{ft}}$$

Sum of Resisting Moments (Strength Ia)

$$\Sigma M_O := MH_{Ia}$$

$$\Sigma M_O = 20861.4 \frac{\text{lb} \cdot \text{ft}}{\text{ft}}$$

Sum of Overturning Moments (Strength Ia)

$$\Sigma V := V_{Ia}$$

$$\Sigma V = 13166.6 \frac{\text{lb}}{\text{ft}}$$

Sum of Vertical Loads (Strength Ia)

$$x := \frac{(\Sigma M_R - \Sigma M_O)}{\Sigma V}$$

$$x = 4.2 \text{ ft}$$

Distance from Point "O" the resultant intersects the base

$$e := \text{abs} \left(\frac{B}{2} - x \right)$$

$$e = 0.32 \text{ ft}$$

Wall eccentricity, **Note:** The vertical stress is assumed to be uniformly distributed over the effective bearing width, B', since the wall is supported by a soil foundation **LRFD [11.6.3.2]**. The effective bearing width is equal to B-2e. .

Eccentricity Capacity:Demand Ratio (CDR)

$$CDR_{Eccentricity} := \frac{e_{max}}{e}$$

Is the CDR > or = to 1.0?

$$CDR_{Eccentricity} = 9.41$$

Sliding Resistance at Base of Wall LRFD [10.6.3.4]:

Factored Sliding Force (Strength Ia):

$$R_u := H_{Ia} \qquad R_u = 4638.4 \frac{\text{lb}f}{\text{ft}}$$

Drained Conditions (Effective Stress):

Compute passive resistance throughout the design life of the wall LRFD [Eq 3.11.5.4-1]:

$$r_{ep1} := (k_{pd} \cdot \gamma_{fd} \cdot y_1 + 2 \cdot c'_{fd} \cdot \sqrt{k_{pd}}) \cdot \cos(\delta_{fd}) \qquad \text{Nominal passive pressure at } y_1$$

$$r_{ep2} := (k_{pd} \cdot \gamma_{fd} \cdot y_2 + 2 \cdot c'_{fd} \cdot \sqrt{k_{pd}}) \cdot \cos(\delta_{fd}) \qquad \text{Nominal passive pressure at } y_2$$

$$R_{ep} := \frac{r_{ep1} + r_{ep2}}{2} \cdot (y_2 - y_1) \qquad R_{ep} = 0 \frac{\text{lb}f}{\text{ft}} \qquad \text{Nominal passive resistance Drained Conditions}$$

416 Note: Passive Resistance shall be neglected in stability computations, unless the base of the wall extends below the depth of maximum scour, freeze-thaw or other disturbances. In the latter case, only the embedment below the greater of these depths shall be considered effective LRFD [11.6.3.5].

Compute sliding resistance between soil and foundation:

$$c := 1.0$$

c = 1.0 for Cast-in-Place
c = 0.8 for Precast

$$\Sigma V := V_{Ia} \qquad \Sigma V = 13166.6 \frac{\text{lb}f}{\text{ft}} \qquad \text{Sum of Vertical Loads (Strength Ia)}$$

$$R_\tau := c \cdot \Sigma V \cdot \tan(\phi'_{fd}) \qquad R_\tau = 5319.6 \frac{\text{lb}f}{\text{ft}} \qquad \text{Nominal sliding resistance Cohesionless Soils}$$

Compute factored resistance against failure by sliding LRFD [10.6.3.4]:

$$\phi_{ep} := 0.5$$

Resistance factor for passive resistance specified in LRFD Table 10.5.5.2.2-1

$$\phi_\tau := 1.0$$

Resistance factor for sliding resistance specified in LRFD Table 11.5.7-1.

$$\phi R_n := \phi_\tau \cdot R_\tau + \phi_{ep} \cdot R_{ep}$$

$$R_R := \phi R_n$$

Factored Sliding Resistance to be used in CDR Calculations:

$$R_R = 5319.646 \frac{\text{lb}f}{\text{ft}}$$

Sliding Capacity:Demand Ratio (CDR)

$$CDR_{Sliding} := \frac{R_R}{R_u}$$

Is the CDR > or = to 1.0?

$$CDR_{Sliding} = 1.15$$

Undrained Conditions (Total Stress):

Compute passive resistance throughout the design life of the wall LRFD [Eq 3.11.5.4-1]:

$$r_{ep1} := (k_{pu} \cdot \gamma_{fd} \cdot y_1 + 2 \cdot Su_{fdu} \cdot \sqrt{k_{pu}}) \cdot \cos(\delta_{fd})$$

Nominal passive pressure at y1

$$r_{ep2} := (k_{pu} \cdot \gamma_{fd} \cdot y_2 + 2 \cdot Su_{fdu} \cdot \sqrt{k_{pu}}) \cdot \cos(\delta_{fd})$$

Nominal passive pressure at y2

$$R_{ep} := \frac{r_{ep1} + r_{ep2}}{2} \cdot (y_2 - y_1) \quad R_{ep} = 0 \frac{lbf}{ft}$$

Nominal passive resistance Drained Conditions

416 Note: Passive Resistance shall be neglected in stability computations, unless the base of the wall extends below the depth of maximum scour, freeze-thaw or other disturbances. In the latter case, only the embedment below the greater of these depths shall be considered effective LRFD [11.6.3.5].

Compute sliding resistance between soil and foundation:

$$c := 1.0$$

c = 1.0 for Cast-in-Place
c = 0.8 for Precast

$$\Sigma V := V_{Ia} \quad \Sigma V = 13166.6 \frac{lbf}{ft}$$

Sum of Vertical Loads (Strength Ia)

$$e = 0.32 \text{ ft}$$

Wall eccentricity, Calculated in above Limiting Eccentricity at Base of Wall (Strength Ia) Section.

$$B = 9 \text{ ft}$$

Footing base width

$$\frac{B}{6} = 1.5 \text{ ft}$$

If e < B/6 the resultant is in the middle one-third

$$\sigma_{vmax} := \frac{\Sigma V}{B} \cdot \left(1 + 6 \cdot \frac{e}{B}\right) \quad \sigma_{vmax} = 1773.8 \frac{lbf}{ft^2}$$

Max vertical stress (if resultant is in the middle one-third of base) LRFD [11.6.3.2-2].

$$\sigma_{vmin} := \frac{\Sigma V}{B} \cdot \left(1 - 6 \cdot \frac{e}{B}\right) \quad \sigma_{vmin} = 1152.1 \frac{lbf}{ft^2}$$

Max vertical stress (if resultant is in the middle one-third of base) LRFD [11.6.3.2-2].

$$q_{max} := \frac{1}{2} \cdot \sigma_{vmax} \quad q_{max} = 886.9 \frac{lbf}{ft^2}$$

Max unit shear resistance as 1/2 max vertical stress LRFD [10.6.3.4].

$$q_{min} := \frac{1}{2} \cdot \sigma_{vmin} \quad q_{min} = 576 \frac{lbf}{ft^2}$$

Minimum unit shear resistance as 1/2 minimum vertical stress LRFD [10.6.3.4].

Determine which Cohesive Soil Resistance Case is Present:

$$Case_1 := \text{if}(q_{max} > Su_{fdu} > q_{min} \geq 0, 1, 0) \quad Case_1 = 0$$

$$Case_2 := \text{if}(Su_{fdu} > q_{max} > q_{min} \geq 0, 1, 0) \quad Case_2 = 1$$

$$Case_3 := \text{if}(q_{max} > q_{min} > Su_{fdu}, 1, 0) \quad Case_3 = 0$$

$$Case_4 := \text{if}(q_{min} < 0, \text{if}(Su_{fdu} < q_{max}, 1, 0), 0) \quad Case_4 = 0$$

$$Case_5 := \text{if}(q_{min} < 0, \text{if}(Su_{fdu} > q_{max}, 1, 0), 0) \quad Case_5 = 0$$

Unit Shear Resistance for Case 1:

$$S_1 := Su_{fdu} - q_{min} = 1524 \frac{\text{lb}}{\text{ft}^2}$$

$$B_1 := \frac{B \cdot (Su_{fdu} - q_{min})}{q_{max} - q_{min}} = 44.1 \text{ ft}$$

$$B_3 := B = 9 \text{ ft}$$

$$I := \frac{1}{2} \cdot S_1 \cdot B_1 = 33617.7 \frac{\text{lb}}{\text{ft}}$$

$$III := S_2 \cdot B_3 = 5184.3 \frac{\text{lb}}{\text{ft}}$$

$$R_{\tau_{case1}} := I + II + III = -14717.7 \frac{\text{lb}}{\text{ft}}$$

$$S_2 := q_{min} = 576 \frac{\text{lb}}{\text{ft}^2}$$

$$B_2 := \frac{B \cdot (q_{max} - Su_{fdu})}{q_{max} - q_{min}} = -35.1 \text{ ft}$$

$$II := S_1 \cdot B_2 = -53519.7 \frac{\text{lb}}{\text{ft}}$$

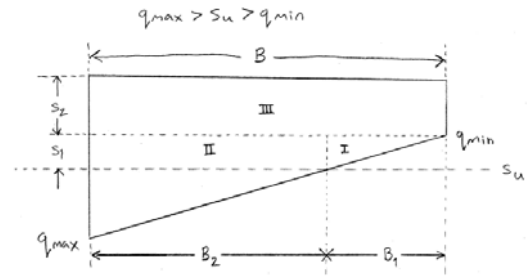

Unit Shear Resistance for Case 2:

$$S_1 := q_{max} - q_{min} = 310.9 \frac{\text{lb}}{\text{ft}^2}$$

$$B = 9 \text{ ft}$$

$$I := \frac{1}{2} \cdot S_1 \cdot B = 1399 \frac{\text{lb}}{\text{ft}}$$

$$R_{\tau_{case2}} := I + II = 6583.3 \frac{\text{lb}}{\text{ft}}$$

$$S_2 := q_{min} = 576 \frac{\text{lb}}{\text{ft}^2}$$

$$II := S_2 \cdot B = 5184.3 \frac{\text{lb}}{\text{ft}}$$

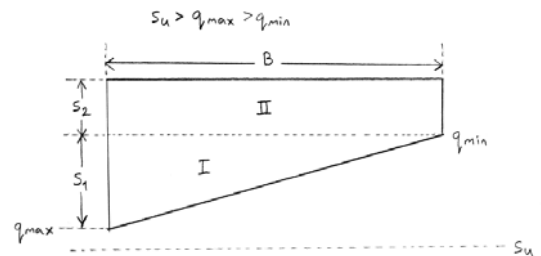

Unit Shear Resistance for Case 3:

$$S_1 := Su_{fdu} = 2100 \frac{\text{lb}}{\text{ft}^2}$$

$$B = 9 \text{ ft}$$

$$I := \frac{1}{2} \cdot S_1 \cdot B = 9450 \frac{\text{lb}}{\text{ft}}$$

$$R_{\tau_{case3}} := I = 9450 \frac{\text{lb}}{\text{ft}}$$

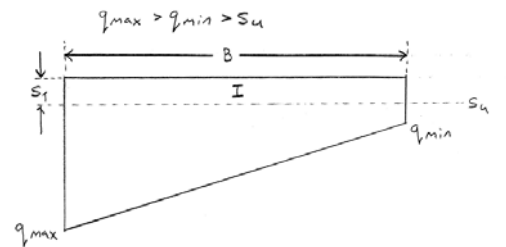

Unit Shear Resistance for Case 4:

$$S_1 := Su_{fdu} = 2100 \frac{\text{lb}}{\text{ft}^2}$$

$$B_3 := \frac{B \cdot (-q_{min})}{q_{max} - q_{min}} = -16.7 \text{ ft}$$

$$B_2 := B - (B_1 + B_3) = -35.1 \text{ ft}$$

$$I := \frac{1}{2} \cdot S_1 \cdot B_1 = 63834.8 \frac{\text{lb}}{\text{ft}}$$

$$R_{\tau_{case4}} := I + II = -9914.6 \frac{\text{lb}}{\text{ft}}$$

$$B_1 := \left(\frac{Su_{fdu}}{q_{max}} \right) \cdot (B - B_3) = 60.8 \text{ ft}$$

$$II := S_1 \cdot B_2 = -73749.5 \frac{\text{lb}}{\text{ft}}$$

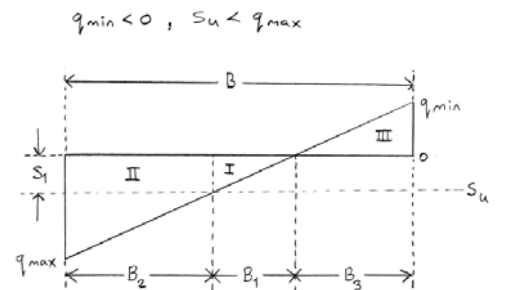

Unit Shear Resistance for Case 5:

$$S_1 := q_{max} = 886.9 \frac{\text{lbf}}{\text{ft}^2}$$

$$B_1 := \frac{B \cdot q_{max}}{q_{max} - q_{min}} = 25.7 \text{ ft}$$

$$B_2 := B - B_1 = -16.7 \text{ ft}$$

$$I := \frac{1}{2} \cdot S_1 \cdot B_1 = 11386.4 \frac{\text{lbf}}{\text{ft}}$$

$$R_{\tau_{case5}} := I = 11386.4 \frac{\text{lbf}}{\text{ft}}$$

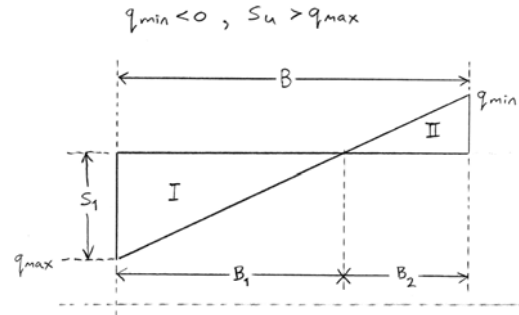

Define the Applicable Case:

$$R_{\tau} := R_{\tau_{case2}}$$

$$R_{\tau} = 6583.3 \frac{\text{lbf}}{\text{ft}}$$

Nominal sliding resistance Cohesive Soils

Compute factored resistance against failure by sliding **LRFD [10.6.3.4]:**

$$\phi_{ep} := 0.5$$

Resistance factor for passive resistance specified in **LRFD Table 10.5.5.2.2-1**

$$\phi_{\tau} := 1.0$$

Resistance factor for sliding resistance specified in **LRFD Table 11.5.7-1.**

$$\phi R_n := \phi_{\tau} \cdot R_{\tau} + \phi_{ep} \cdot R_{ep}$$

$$R_R := \phi R_n$$

Factored Sliding Resistance to be used in CDR Calculations:

$$R_R = 6583.293 \frac{\text{lbf}}{\text{ft}}$$

Sliding Capacity: Demand Ratio (CDR)

$$CDR_{Sliding} := \frac{R_R}{R_u}$$

Is the CDR > or = to 1.0?

$$CDR_{Sliding} = 1.42$$

RETAINING WALL 6

Objective: To evaluate the external stability of CIP wall's with level backfill (no backslope).
Method: In accordance with ODOT Bridge Design Manual, 2024 [Sect. 307] LRFD Bridge Design Specifications, 8th Ed., Nov. 2017, [Sect. 11.6.1, Sect. 11.6.2, and Sect. 11.6.3].

Givens:

Backfill Soil Design Parameters:

$$\phi'_f := 30 \text{ deg}$$

Effective angle of internal friction

$$\gamma_f := 120 \frac{\text{lb}}{\text{ft}^3}$$

Unit weight

$$c'_f := 0 \frac{\text{lb}}{\text{ft}^2}$$

Effective Cohesion

$$\delta := 0.67 \cdot \phi'_f$$

$$\delta = 20.1 \text{ deg}$$

Friction angle between backfill and wall taken as specified in **LRFD BDS C3.11.5.3 (degrees)**

Foundation Soil Design Parameters:

Drained Conditions (Effective Stress):

$$\phi'_{fd} := 26 \text{ deg}$$

Effective angle of internal friction

$$\gamma_{fd} := 125 \frac{\text{lb}}{\text{ft}^3}$$

Unit weight

$$c'_{fd} := 200 \frac{\text{lb}}{\text{ft}^2}$$

Effective Cohesion

$$\delta_{fd} := 0.67 \cdot \phi'_{fd}$$

$$\delta_{fd} = 17.4 \text{ deg}$$

Friction angle between foundation soils and footing taken as specified in **LRFD BDS C3.11.5.3 (degrees)**

Undrained Conditions (Total Stress):

$$\phi_{fdu} := 0 \text{ deg}$$

Angle of internal friction (Same as Drained Conditions if granular soils)

$$\gamma_{fd} = 125 \frac{\text{lb}}{\text{ft}^3}$$

Unit weight

$$Su_{fdu} := 2000 \frac{\text{lb}}{\text{ft}^2}$$

Undrained Shear Strength

$$\delta_{fdu} := 0.67 \cdot \phi_{fdu}$$

$$\delta_{fdu} = 0 \text{ deg}$$

Friction angle between foundation soils and footing taken as specified in **LRFD BDS C3.11.5.3 (degrees)**

Foundation Surcharge Soil Parameters:

$$\gamma_q := 120 \frac{\text{lb}}{\text{ft}^3}$$

Unit weight of Soil above bearing depth (Used in Bearing Resistance of Soil Calculation **LRFD 10.6.3.1.2a-1**)

Other Parameters:

$$\gamma_c := 150 \frac{\text{lb}}{\text{ft}^3}$$

Concrete Unit weight

$$\gamma_p := 150 \frac{\text{lb}}{\text{ft}^3}$$

Pavement Unit weight

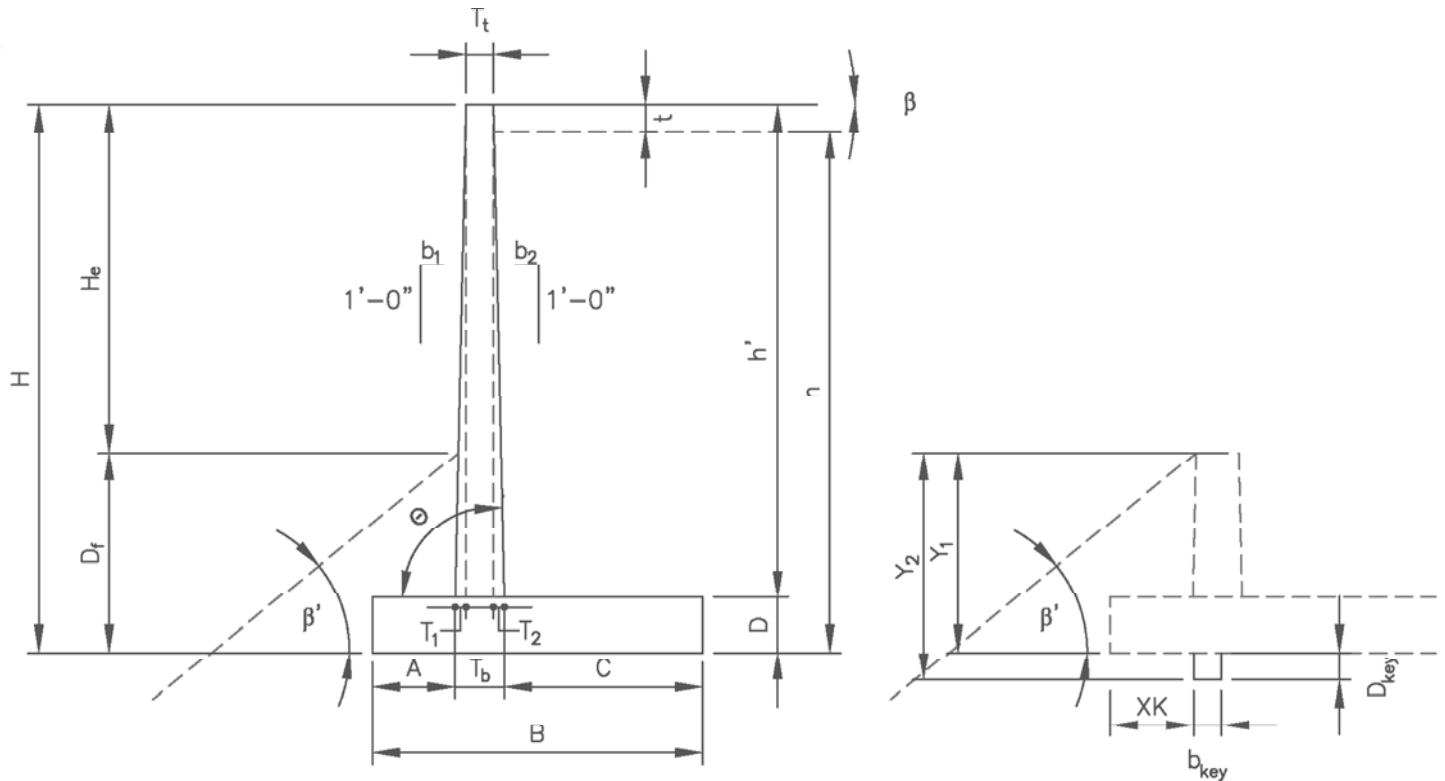

Wall Geometry:

$H_e := 8.68 \text{ ft}$

$D_f := 3.5 \text{ ft}$

$H := H_e + D_f$

$H = 12.2 \text{ ft}$

$T_t := 1.5 \text{ ft}$

$b_1 := 1.50 \cdot \left(\frac{\text{in}}{\text{ft}}\right)$

$b_2 := 0 \cdot \left(\frac{\text{in}}{\text{ft}}\right)$

$\beta := 0 \text{ deg}$

$\beta' := 0 \text{ deg}$

$t := 0.5 \cdot \text{ft}$

Inclination of ground slope:

- Horizontal: **0**
- 3H:1V: **18.435**
- 2H:1V: **26.565**
- 1.5H:1V: **33.690**

Exposed wall height

Footing cover at Toe

Note: Where the potential for scour, erosion of undermining exists, spread footings shall be located to bear below the maximum depth of scour or undermining. Spread footings shall be located below the depth of potential frost. **LRFD BDS 10.6.1.2.**

Design Wall Height

Stem thickness at top of wall

Frontwall batter, (b1H:12V)

Backwall batter, (b2H:12V)

Inclination of ground slope behind face of wall.
Horizontal backfill behind CIP wall, $\beta = 0 \text{ deg}$

Inclination of ground slope in front of wall. If it is horizontal backfill in front of CIP wall, $\beta' = 0 \text{ deg}$. A negative angle (-) indicates grades slope up from front of wall. Positive angle (+) indicates grade slope down from wall as shown in above figure.

Pavement thickness

Preliminary Wall Dimensioning:

$B := 10 \text{ ft}$	$\frac{2}{5} \cdot H = 4.87 \text{ ft}$ to $\frac{3}{5} \cdot H = 7.31 \text{ ft}$	Footing base width (2/5H to 3/5H)
$A := 1.5 \text{ ft}$	$\frac{H}{8} = 1.52 \text{ ft}$ to $\frac{H}{5} = 2.44 \text{ ft}$	Toe projection (H/8 to H/5)
$D := 2 \text{ ft}$	$\frac{H}{8} = 1.52 \text{ ft}$ to $\frac{H}{5} = 2.44 \text{ ft}$	Footing thickness (H/8 to H/5)

Shear Key Dimensioning:

$D_{key} := 0 \text{ ft}$	Depth of shear key from bottom of footing Note: Footings on rock typically require shear key
$b_{key} := 0 \text{ ft}$	Width of shear key
$XK := A$	Distance from toe to shear key

Other Wall Dimensions:

$h' := H - D$	$h' = 10.2 \text{ ft}$	Stem height
$T_1 := b_1 \cdot h'$	$T_1 = 1.273 \text{ ft}$	Stem front batter width
$T_2 := b_2 \cdot h'$	$T_2 = 0 \text{ ft}$	Stem back batter width
$T_b := T_1 + T_2 + T_t$	$T_b = 2.773 \text{ ft}$	Stem thickness at bottom of wall
$C := B - A - T_b$	$C = 5.728 \text{ ft}$	Heel projection
$\theta := 90 \text{ deg}$		Angle of back face of wall to horizontal = $atan(12/b_2)$
$b := 12 \text{ in}$	$b = 1 \text{ ft}$	Concrete strip width (for design)
$y_1 := 3.5 \cdot \text{ft}$	$y_1 = 3.5 \text{ ft}$	Depth to where passive pressure may begin to be utilized in front of wall. (Typically Df)
$y_2 := D_f + D_{key}$	$y_2 = 3.5 \text{ ft}$	Bottom of shear key/footing depth i.e. depth to where passive pressure may no longer be utilized.
$h := H - t$	$h = 11.7 \text{ ft}$	Height of retained fill at back of heel

Live Load Surcharge Parameters:

$\lambda := 20 \text{ ft}$	Horizontal distance from the back of the wall to point of traffic surcharge load
$SUR := \text{if} \left(\lambda < \frac{H}{2}, 250 \frac{\text{lb}}{\text{ft}^2}, 100 \frac{\text{lb}}{\text{ft}^2} \right) = 100 \frac{\text{lb}}{\text{ft}^2}$	Live load surcharge (per LRFD BDS [3.11.6.4]) Note: If vehicular loading is within 1 ft of the backface of the wall and with a design height, H, less than 20 ft, see LRFD BDS Section 3.11.6.4 and Table 3.11.6.4-2 for adjusted surcharge load calculation. Note: when $\lambda < H/2$, SUR equal 100 psf to account for construction loads

Calculations:

Earth Pressure Coefficients:

Backfill Active Earth:

$$\Gamma := \left(1 + \sqrt{\frac{(\sin(\phi'_f + \delta) \cdot \sin(\phi'_f - \beta))}{(\sin(\theta - \delta) \cdot \sin(\theta + \beta))}} \right)^2 \quad \Gamma = 2.687$$

$$k_{af} := \left(\frac{(\sin(\theta + \phi'_f))^2}{(\Gamma \cdot (\sin(\theta))^2 \cdot \sin(\theta - \delta))} \right) \quad k_{af} = 0.297 \quad \text{Active Earth Pressure Coefficient (per LRFD Sect. 3.11.5.3)}$$

Foundation Soil Passive Earth:

Drained Conditions assuming ($\phi'_{fd} > 0$):

Input Parameters for **LRFD Figure 3.11.5.4-2**, assumes $\theta = 90$ degrees

$$\frac{-\beta'}{\phi'_{fd}} = 0$$

$$\frac{-\delta_{fd}}{\phi'_{fd}} = -0.67$$

$$k'_p := 3.54$$

Passive Earth Pressure Coefficient from **LRFD Figure 3.11.5.4-2**

Determine Reduction Factor (R) by interpolation:

$$R_d := 0.828$$

Reduction Factor

$$k_{pd} := R_d \cdot k'_p \quad k_{pd} = 2.931$$

Passive Earth Pressure Coefficient for Drained Conditions

Undrained Conditions ($\phi_{fdu} > 0$): **Note:** Expand window below to complete calculation

Undrained Conditions:

$$k_{pu} := \text{if}(\phi_{fdu} > 0, k_{pu}, 1) \quad k_{pu} = 1$$

Passive Earth Pressure Coefficient for Resistance Undrained Conditions

Compute Unfactored Loads LRFD [Tables 3.4.1-1 and 3.4.1-2]:

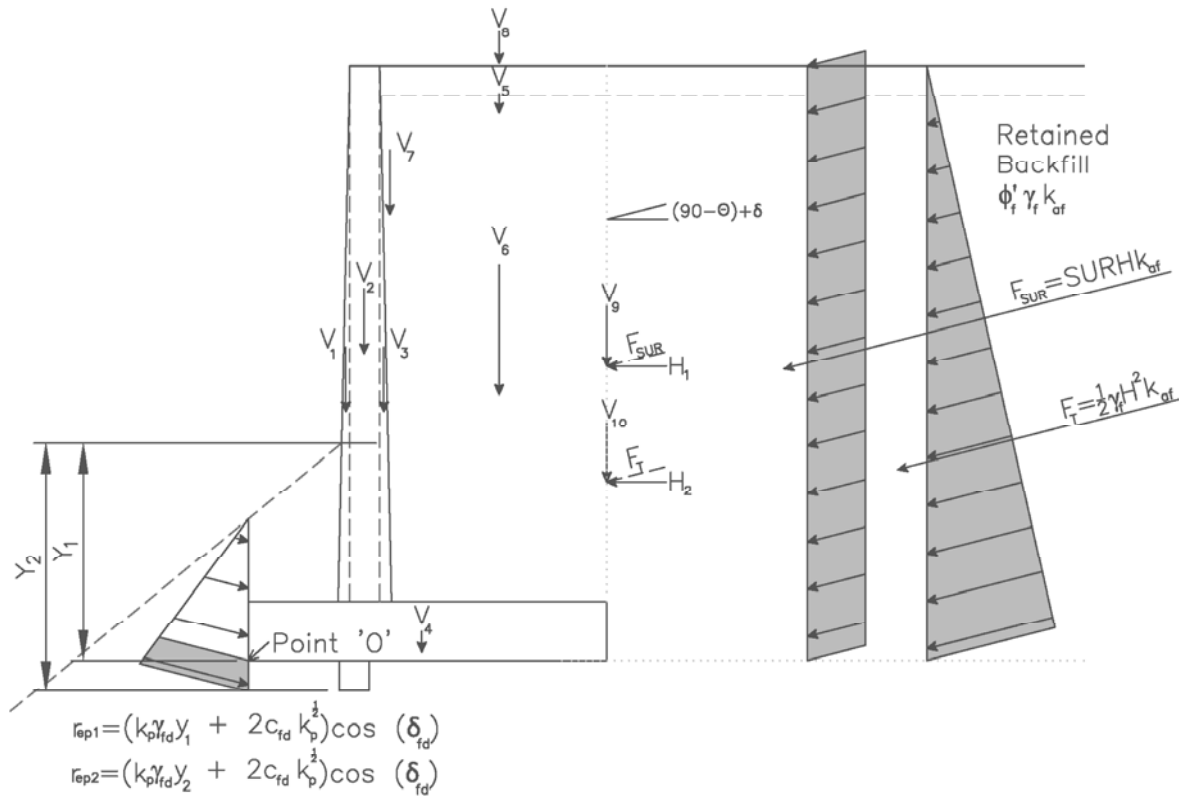

$$F_T := \frac{1}{2} \cdot \gamma_f \cdot H^2 \cdot k_{af}$$

$$F_T = 2646 \frac{\text{lb}}{\text{ft}}$$

Active Earth Force Resultant (EH)

$$F_{SUR} := SUR \cdot H \cdot k_{af}$$

$$F_{SUR} = 3621 \frac{\text{lb}}{\text{ft}}$$

Live Load Surcharge (LS)

Vertical Loads:

$$V_1 := \frac{1}{2} \cdot T_1 \cdot h' \cdot \gamma_c$$

$$V_1 = 971.6 \frac{\text{lb}}{\text{ft}}$$

Wall stem front batter (DC)

$$V_2 := T_t \cdot h' \cdot \gamma_c$$

$$V_2 = 2290.5 \frac{\text{lb}}{\text{ft}}$$

Wall stem (DC)

$$V_3 := \frac{1}{2} \cdot T_2 \cdot h' \cdot \gamma_c$$

$$V_3 = 0 \frac{\text{lb}}{\text{ft}}$$

Wall stem back batter (DC)

$$V_4 := D \cdot B \cdot \gamma_c$$

$$V_4 = 3000 \frac{\text{lb}}{\text{ft}}$$

Wall Footing (DC)

$$V_5 := t \cdot (T_2 + C) \cdot \gamma_p$$

$$V_5 = 429.6 \frac{\text{lb}}{\text{ft}}$$

Pavement (DC)

$$V_6 := C \cdot (h' - t) \cdot \gamma_f$$

$$V_6 = 6653.1 \frac{\text{lb}}{\text{ft}}$$

Soil Backfill - Heel (EV)

$$V_7 := \frac{1}{2} \cdot b_2 \cdot (h' - t)^2 \cdot \gamma_f$$

$$V_7 = 0 \frac{\text{lb}}{\text{ft}}$$

Soil Backfill - Batter (EV)

$$V_8 := SUR \cdot (T_2 + C)$$

$$V_8 = 572.8 \frac{\text{lb}}{\text{ft}}$$

Live Load Surcharge above Heel- (LS)
- Strength lb

$$V_9 := F_{SUR} \cdot \sin(90 \cdot \text{deg} - \theta + \delta)$$

$$V_9 = 124.4 \frac{\text{lb}}{\text{ft}}$$

Live Load Surcharge Resultant (vertical comp. - LS)
- Strength Ia

$$V_{10} := F_T \cdot \sin(90 \cdot \text{deg} - \theta + \delta)$$

$$V_{10} = 909.3 \frac{\text{lb}}{\text{ft}}$$

Active earth force resultant (vertical component - EH)

Moment Arm:

Moments produced from vertical loads about Point 'O'

$$d_{v1} := A + \frac{2}{3} \cdot T_1 = 2.3 \text{ ft}$$

$$d_{v2} := A + T_1 + \frac{T_1}{2} = 3.5 \text{ ft}$$

$$d_{v3} := A + T_1 + T_1 + \frac{T_2}{3} = 4.3 \text{ ft}$$

$$d_{v4} := \frac{B}{2} = 5 \text{ ft}$$

$$d_{v5} := B - \frac{T_2 + C}{2} = 7.1 \text{ ft}$$

$$d_{v6} := B - \frac{C}{2} = 7.1 \text{ ft}$$

$$d_{v7} := A + T_1 + T_1 + \left(\frac{2}{3} \cdot b_2 \cdot (h' - t) \right) = 4.3 \text{ ft}$$

$$d_{v8} := B - \frac{T_2 + C}{2} = 7.1 \text{ ft}$$

$$d_{v9} := B = 10 \text{ ft}$$

$$d_{v10} := B = 10 \text{ ft}$$

Moment:

$$MV_1 := V_1 \cdot d_{v1} = 2281.5 \text{ lbf}$$

$$MV_2 := V_2 \cdot d_{v2} = 8068.3 \text{ lbf}$$

$$MV_3 := V_3 \cdot d_{v3} = 0 \text{ lbf}$$

$$MV_4 := V_4 \cdot d_{v4} = 15000 \text{ lbf}$$

$$MV_5 := V_5 \cdot d_{v5} = 3065.5 \text{ lbf}$$

$$MV_6 := V_6 \cdot d_{v6} = 47477.9 \text{ lbf}$$

$$MV_7 := V_7 \cdot d_{v7} = 0 \text{ lbf}$$

$$MV_8 := V_8 \cdot d_{v8} = 4087.3 \text{ lbf}$$

$$MV_9 := V_9 \cdot d_{v9} = 1244.3 \text{ lbf}$$

$$MV_{10} := V_{10} \cdot d_{v10} = 9093.1 \text{ lbf}$$

Horizontal Loads:

$$H_1 := F_{SUR} \cdot \cos(90 \cdot \text{deg} - \theta + \delta)$$

$$H_1 = 340 \frac{\text{lbf}}{\text{ft}}$$

Live Load Surcharge Resultant (horizontal comp. - LS)

$$H_2 := F_T \cdot \cos(90 \cdot \text{deg} - \theta + \delta)$$

$$H_2 = 2484.8 \frac{\text{lbf}}{\text{ft}}$$

Active Earth Force Resultant (horizontal comp. - EH)

Moment Arm:

$$d_{h1} := \frac{H}{2}$$

$$d_{h1} = 6.1 \text{ ft}$$

$$MH_1 := H_1 \cdot d_{h1}$$

$$MH_1 = 2070.7 \frac{\text{lbf} \cdot \text{ft}}{\text{ft}}$$

$$d_{h2} := \frac{H}{3}$$

$$d_{h2} = 4.1 \text{ ft}$$

$$MH_2 := H_2 \cdot d_{h2}$$

$$MH_2 = 10088.3 \frac{\text{lbf} \cdot \text{ft}}{\text{ft}}$$

Unfactored Loads by Load Type:

$$V_{DC} := V_1 + V_2 + V_3 + V_4 + V_5$$

$$V_{DC} = 6691.6 \frac{\text{lbf}}{\text{ft}}$$

$$V_{EV} := V_6 + V_7$$

$$V_{EV} = 6653.1 \frac{\text{lbf}}{\text{ft}}$$

$$V_{LS_Ia} := V_9$$

$$V_{LS_Ia} = 124.4 \frac{\text{lbf}}{\text{ft}}$$

$$V_{LS_Ib} := V_8 + V_9$$

$$V_{LS_Ib} = 697.2 \frac{\text{lbf}}{\text{ft}}$$

$$V_{EH} := V_{10}$$

$$V_{EH} = 909.3 \frac{\text{lbf}}{\text{ft}}$$

$$H_{LS} := H_1$$

$$H_{LS} = 340 \frac{\text{lbf}}{\text{ft}}$$

$$H_{EH} := H_2$$

$$H_{EH} = 2484.8 \frac{\text{lbf}}{\text{ft}}$$

Unfactored Moments by Load Type

$M_{DC} := MV_1 + MV_2 + MV_3 + MV_4 + MV_5$	$M_{DC} = 28415.3 \frac{\text{lb} \cdot \text{ft}}{\text{ft}}$
$M_{EV} := MV_6 + MV_7$	$M_{EV} = 47477.9 \frac{\text{lb} \cdot \text{ft}}{\text{ft}}$
$M_{LSV_Ia} := MV_9$	$M_{LSV_Ia} = 1244.3 \frac{\text{lb} \cdot \text{ft}}{\text{ft}}$
$M_{LSV_Ib} := MV_8 + MV_9$	$M_{LSV_Ib} = 5331.6 \frac{\text{lb} \cdot \text{ft}}{\text{ft}}$
$M_{EH1} := MV_{10}$	$M_{EH1} = 9093.1 \frac{\text{lb} \cdot \text{ft}}{\text{ft}}$
$M_{LSH} := MH_1$	$M_{LSH} = 2070.7 \frac{\text{lb} \cdot \text{ft}}{\text{ft}}$
$M_{EH2} := MH_2$	$M_{EH2} = 10088.3 \frac{\text{lb} \cdot \text{ft}}{\text{ft}}$

Load Combination Limit States:

$\eta := 1$ LRFD Load Modifier
 Strength Limit State I: EV(min) = 1.00 EV(max) = 1.35
 EH(min) = 0.90 EH(max) = 1.50
 LS = 1.75

Strength Limit State Ia: (Sliding and Eccentricity)	$Ia_{DC} := 0.9$	$Ia_{EV} := 1$	$Ia_{EH} := 1.5$	$Ia_{LS} := 1.75$
Strength Limit State Ib: (Bearing Capacity)	$Ib_{DC} := 1.25$	$Ib_{EV} := 1.35$	$Ib_{EH} := 1.5$	$Ib_{LS} := 1.75$

Factored Vertical Loads by Limit State:

$V_{Ia} := \eta \cdot ((Ia_{DC} \cdot V_{DC}) + (Ia_{EV} \cdot V_{EV}) + (Ia_{EH} \cdot V_{EH}) + (Ia_{LS} \cdot V_{LS_Ia}))$	$V_{Ia} = 14257.2 \frac{\text{lb}}{\text{ft}}$
$V_{Ib} := \eta \cdot ((Ib_{DC} \cdot V_{DC}) + (Ib_{EV} \cdot V_{EV}) + (Ib_{EH} \cdot V_{EH}) + (Ib_{LS} \cdot V_{LS_Ib}))$	$V_{Ib} = 19930.2 \frac{\text{lb}}{\text{ft}}$

Factored Horizontal Loads by Limit State:

$H_{Ia} := \eta \cdot ((Ia_{LS} \cdot H_{LS}) + (Ia_{EH} \cdot H_{EH}))$	$H_{Ia} = 4322.2 \frac{\text{lb}}{\text{ft}}$
$H_{Ib} := \eta \cdot ((Ib_{LS} \cdot H_{LS}) + (Ib_{EH} \cdot H_{EH}))$	$H_{Ib} = 4322.2 \frac{\text{lb}}{\text{ft}}$

Factored Moments Produced by Vertical Loads by Limit State:

$MV_{Ia} := \eta \cdot ((Ia_{DC} \cdot M_{DC}) + (Ia_{EV} \cdot M_{EV}) + (Ia_{EH} \cdot M_{EH1}) + (Ia_{LS} \cdot M_{LSV_Ia}))$	$MV_{Ia} = 88868.8 \frac{\text{lb} \cdot \text{ft}}{\text{ft}}$
$MV_{Ib} := \eta \cdot ((Ib_{DC} \cdot M_{DC}) + (Ib_{EV} \cdot M_{EV}) + (Ib_{EH} \cdot M_{EH1}) + (Ib_{LS} \cdot M_{LSV_Ib}))$	$MV_{Ib} = 122584.1 \frac{\text{lb} \cdot \text{ft}}{\text{ft}}$

Factored Moments Produced by Horizontal Loads by Limit State:

$MH_{Ia} := \eta \cdot ((Ia_{LS} \cdot M_{LSH}) + (Ia_{EH} \cdot M_{EH2}))$	$MH_{Ia} = 18756.1 \frac{\text{lb} \cdot \text{ft}}{\text{ft}}$
$MH_{Ib} := \eta \cdot ((Ib_{LS} \cdot M_{LSH}) + (Ib_{EH} \cdot M_{EH2}))$	$MH_{Ib} = 18756.1 \frac{\text{lb} \cdot \text{ft}}{\text{ft}}$

Compute Bearing Resistance:

Compute the resultant location about the toe of the base length (distance from "O") Strength lb:

$\Sigma M_R := MV_{lb}$	$\Sigma M_R = 122584.1 \frac{\text{lb} \cdot \text{ft}}{\text{ft}}$	Sum of Resisting Moments (Strength lb)
$\Sigma M_O := MH_{lb}$	$\Sigma M_O = 18756.1 \frac{\text{lb} \cdot \text{ft}}{\text{ft}}$	Sum of Overturning Moments (Strength lb)
$\Sigma V := V_{lb}$	$\Sigma V = 19930.2 \frac{\text{lb}}{\text{ft}}$	Sum of Vertical Loads (Strength lb)
$x := \frac{(\Sigma M_R - \Sigma M_O)}{\Sigma V}$	$x = 5.2 \text{ ft}$	Distance from Point "O" the resultant intersects the base

$e := \left \frac{B}{2} - x \right $	$e = 0.21 \text{ ft}$	Wall eccentricity, Note: The vertical stress is assumed to be uniformly distributed over the effective bearing width, B', since the wall is supported by a soil foundation LRFD [11.6.3.2] . The effective bearing width is equal to B-2e. When the foundation eccentricity is negative the absolute value is used.
---------------------------------------	-----------------------	---

Foundation Layout:

$B' := B - 2 \cdot e$	$B' = 9.6 \text{ ft}$	Effective Footing Width
$L' := 91 \text{ ft}$		Effective Footing Length (Assumed)
$H' := H_{lb}$	$H' = 4322.2 \frac{\text{lb}}{\text{ft}}$	Summation of Horizontal Loads (Strength lb)
$V' := V_{lb}$	$V' = 19930.2 \frac{\text{lb}}{\text{ft}}$	Summation of Vertical Loads (Strength lb)
$D_f = 3.5 \text{ ft}$		Footing embedment
$d_w := 0 \text{ ft}$		Depth of Groundwater below ground surface at front of wall.

Drained Conditions (Effective Stress):

$N_q := \text{if} \left(\phi'_{fd} > 0, e^{\pi \cdot \tan(\phi'_{fd})} \cdot \tan \left(45 \text{ deg} + \frac{\phi'_{fd}}{2} \right), 1.0 \right)$	$N_q = 11.85$
$N_c := \text{if} \left(\phi'_{fd} > 0, \frac{N_q - 1}{\tan(\phi'_{fd})}, 5.14 \right)$	$N_c = 22.25$
$N_\gamma := 2 \cdot (N_q + 1) \cdot \tan(\phi'_{fd})$	$N_\gamma = 12.5$

Compute shape correction factors per LRFD [Table 10.6.3.1.2a-3]:

$s_c := \text{if} \left(\phi'_{fd} > 0, 1 + \left(\frac{B'}{L'} \right) \cdot \left(\frac{N_q}{N_c} \right), 1 + \left(\frac{B'}{5 \cdot L'} \right) \right)$	$s_c = 1.056$
$s_q := \text{if} \left(\phi'_{fd} > 0, 1 + \left(\frac{B'}{L'} \right) \cdot \tan(\phi'_{fd}), 1 \right)$	$s_q = 1.051$
$s_\gamma := \text{if} \left(\phi'_{fd} > 0, 1 - 0.4 \cdot \left(\frac{B'}{L'} \right), 1 \right)$	$s_\gamma = 0.958$

Load inclination factors:

$$i_q := 1$$

$$i_\gamma := 1$$

$$i_c := 1$$

Assumed to be 1.0, see **LRFD BDS C10.6.3.1.2a**.
"Most geotechnical engineers do not use the load inclination factors". If desired, use LRFD Equations [10.6.3.1.2a-5] thru [10.6.3.1.2a-9].

Compute groundwater depth correction factors per LRFD [Table 10.6.3.1.2a-2]:

$$C_{wq} := \text{if}(d_w \geq D_f, 1.0, 0.5) \qquad C_{wq} = 0.5$$

$$C_{wy} := \text{if}(d_w \geq (1.5 \cdot B) + D_f, 1.0, 0.5) \qquad C_{wy} = 0.5$$

Depth Correction Factor per Hanson (1970):

$$d_q := \text{if}\left(\frac{D_f}{B} \leq 1, 1 + 2 \cdot \tan(\phi'_{fd}) \cdot (1 - \sin(\phi'_{fd}))^2 \cdot \frac{D_f}{B}, 1 + 2 \cdot \tan(\phi'_{fd}) \cdot (1 - \sin(\phi'_{fd}))^2 \cdot \text{atan}\left(\frac{D_f}{B}\right)\right)$$

$$d_q = 1.11$$

Compute modified bearing capacity factors LRFD [Equation 10.6.3.1.2a-2 to 10.6.3.1.2a-4]:

$$N_{cm} := N_c \cdot s_c \cdot i_c \qquad N_{cm} = 23.502$$

$$N_{qm} := N_q \cdot s_q \cdot i_q \qquad N_{qm} = 12.463$$

$$N_{\gamma m} := N_\gamma \cdot s_\gamma \cdot i_\gamma \qquad N_{\gamma m} = 12.011$$

Compute nominal bearing resistance. LRFD [Eq 10.6.3.1.2a-1]:

$$q_{nd} := c'_{fd} \cdot N_{cm} + \gamma_{fd} \cdot D_f \cdot N_{qm} \cdot d_q \cdot C_{wq} + 0.5 \cdot \gamma_{fd} \cdot B' \cdot N_{\gamma m} \cdot C_{wy} \qquad q_{nd} = 11316.4 \frac{\text{lb}}{\text{ft}^2}$$

Compute factored bearing resistance. LRFD [Eq 10.6.3.1.1]:

$$\phi_b := 0.55$$

Bearing resistance factor LRFD Table 11.5.7-1.

$$q_{Rd} := \phi_b \cdot q_{nd} \qquad q_{Rd} = 6.2 \text{ ksf}$$

Factored bearing resistance Drained Conditions

Undrained Conditions (Effective Stress):

$$N_q := \text{if}\left(\phi_{fd} > 0, e^{\pi \cdot \tan(\phi_{fd})} \cdot \tan\left(45 \text{ deg} + \frac{\phi_{fd}}{2}\right), 1.0\right) \qquad N_q = 1$$

$$N_c := \text{if}\left(\phi_{fd} > 0, \frac{N_q - 1}{\tan(\phi_{fd})}, 5.14\right) \qquad N_c = 5.14$$

$$N_\gamma := 2 \cdot (N_q + 1) \cdot \tan(\phi_{fd}) \qquad N_\gamma = 0$$

Compute shape correction factors per LRFD [Table 10.6.3.1.2a-3]:

$$s_c := \text{if} \left(\phi_{fd_u} > 0, 1 + \left(\frac{B'}{L'} \right) \cdot \left(\frac{N_q}{N_c} \right), 1 + \left(\frac{B'}{5 \cdot L'} \right) \right) \quad s_c = 1.021$$

$$s_q := \text{if} \left(\phi_{fd_u} > 0, 1 + \left(\frac{B'}{L'} \right) \cdot \tan(\phi_{fd_u}), 1 \right) \quad s_q = 1$$

$$s_\gamma := \text{if} \left(\phi_{fd_u} > 0, 1 - 0.4 \cdot \left(\frac{B'}{L'} \right), 1 \right) \quad s_\gamma = 1$$

Load inclination factors:

$$i_q := 1$$

$$i_\gamma := 1$$

$$i_c := 1$$

Assumed to be 1.0, see LRFD BDS C10.6.3.1.2a. "Most geotechnical engineers do not use the load inclination factors". If desired, use LRFD Equations [10.6.3.1.2a-5] thru [10.6.3.1.2a-9].

Compute modified bearing capacity factors LRFD [Equation 10.6.3.1.2a-2 to 10.6.3.1.2a-4]:

$$N_{cm} := N_c \cdot s_c \cdot i_c \quad N_{cm} = 5.248$$

$$N_{qm} := N_q \cdot s_q \cdot i_q \quad N_{qm} = 1$$

$$N_{\gamma m} := N_\gamma \cdot s_\gamma \cdot i_\gamma \quad N_{\gamma m} = 0$$

Depth Correction Factor per Hanson (1970):

$$d_q := \text{if} \left(\frac{D_f}{B} \leq 1, 1 + 2 \cdot \tan(\phi_{fd_u}) \cdot (1 - \sin(\phi_{fd_u}))^2 \cdot \frac{D_f}{B}, 1 + 2 \cdot \tan(\phi_{fd_u}) \cdot (1 - \sin(\phi_{fd_u}))^2 \cdot \text{atan} \left(\frac{D_f}{B} \right) \right)$$

$$d_q = 1$$

Compute nominal bearing resistance. LRFD [Eq 10.6.3.1.2a-1]:

$$q_{nu} := Su_{fd_u} \cdot N_{cm} + \gamma_{fd} \cdot D_f \cdot N_{qm} \cdot d_q \cdot C_{wq} + 0.5 \cdot \gamma_{fd} \cdot B' \cdot N_{\gamma m} \cdot C_{w\gamma} \quad q_{nu} = 10715.2 \frac{\text{lbf}}{\text{ft}^2}$$

Compute factored bearing resistance. LRFD [Eq 10.6.3.1.1]:

$$\phi_b := 0.55$$

$$q_{Ru} := \phi_b \cdot q_{nu} \quad q_{Ru} = 5.9 \text{ ksf}$$

Bearing resistance factor LRFD Table 11.5.7-1.

Factored bearing resistance Undrained Conditions

Factored Bearing Resistance Drained vs. Undrained Conditions:

Drained Conditions: $q_{Rd} = 6.2 \text{ ksf}$

Undrained Conditions: $q_{Ru} = 5.9 \text{ ksf}$

Evaluate External Stability of Wall:

Compute the ultimate bearing stress :

$$e = 0.21 \text{ ft}$$

$$\sigma_V := \frac{\Sigma V}{B - 2 \cdot e} \quad \sigma_V = 2.08 \text{ ksf}$$

Bearing Capacity:Demand Ratio (CDR)

Drained Conditions:	$CDR_{Bearing_D} := \frac{q_{Rd}}{\sigma_V}$	Is the CDR > or = to 1.0?	$CDR_{Bearing_D} = 2.99$
---------------------	---	---------------------------	---------------------------

Undrained Conditions:	$CDR_{Bearing_U} := \frac{q_{Ru}}{\sigma_V}$	Is the CDR > or = to 1.0?	$CDR_{Bearing_U} = 2.83$
-----------------------	---	---------------------------	---------------------------

Limiting Eccentricity at Base of Wall (Strength Ia):

Compute the resultant location about the toe "O" of the base length (distance from Pivot):

$$e_{max} := \frac{B}{3}$$

$$e_{max} = 3.3 \text{ ft}$$

Maximum Eccentricity **LRFD [11.6.3.3.]**
Equals B/3 for soil.

$$\Sigma M_R := MV_{Ia}$$

$$\Sigma M_R = 88868.8 \frac{\text{lb} \cdot \text{ft}}{\text{ft}}$$

Sum of Resisting Moments (Strength Ia)

$$\Sigma M_O := MH_{Ia}$$

$$\Sigma M_O = 18756.1 \frac{\text{lb} \cdot \text{ft}}{\text{ft}}$$

Sum of Overturning Moments (Strength Ia)

$$\Sigma V := V_{Ia}$$

$$\Sigma V = 14257.2 \frac{\text{lb}}{\text{ft}}$$

Sum of Vertical Loads (Strength Ia)

$$x := \frac{(\Sigma M_R - \Sigma M_O)}{\Sigma V}$$

$$x = 4.9 \text{ ft}$$

Distance from Point "O" the resultant intersects the base

$$e := \text{abs} \left(\frac{B}{2} - x \right)$$

$$e = 0.08 \text{ ft}$$

Wall eccentricity, **Note:** The vertical stress is assumed to be uniformly distributed over the effective bearing width, B', since the wall is supported by a soil foundation **LRFD [11.6.3.2]**. The effective bearing width is equal to B-2e. .

Eccentricity Capacity:Demand Ratio (CDR)

$$CDR_{Eccentricity} := \frac{e_{max}}{e}$$

Is the CDR > or = to 1.0?

$$CDR_{Eccentricity} = 40.50$$

Sliding Resistance at Base of Wall LRFD [10.6.3.4]:

Factored Sliding Force (Strength Ia):

$$R_u := H_{fa} \qquad R_u = 4322.2 \frac{\text{lb}f}{\text{ft}}$$

Drained Conditions (Effective Stress):

Compute passive resistance throughout the design life of the wall LRFD [Eq 3.11.5.4-1]:

$$r_{ep1} := (k_{pd} \cdot \gamma_{fd} \cdot y_1 + 2 \cdot c'_{fd} \cdot \sqrt{k_{pd}}) \cdot \cos(\delta_{fd}) \qquad \text{Nominal passive pressure at } y_1$$

$$r_{ep2} := (k_{pd} \cdot \gamma_{fd} \cdot y_2 + 2 \cdot c'_{fd} \cdot \sqrt{k_{pd}}) \cdot \cos(\delta_{fd}) \qquad \text{Nominal passive pressure at } y_2$$

$$R_{ep} := \frac{r_{ep1} + r_{ep2}}{2} \cdot (y_2 - y_1) \qquad R_{ep} = 0 \frac{\text{lb}f}{\text{ft}} \qquad \text{Nominal passive resistance Drained Conditions}$$

416 Note: Passive Resistance shall be neglected in stability computations, unless the base of the wall extends below the depth of maximum scour, freeze-thaw or other disturbances. In the latter case, only the embedment below the greater of these depths shall be considered effective LRFD [11.6.3.5].

Compute sliding resistance between soil and foundation:

$$c := 1.0$$

c = 1.0 for Cast-in-Place
c = 0.8 for Precast

$$\Sigma V := V_{Ia}$$

$$\Sigma V = 14257.2 \frac{\text{lb}f}{\text{ft}} \qquad \text{Sum of Vertical Loads (Strength Ia)}$$

$$R_\tau := c \cdot \Sigma V \cdot \tan(\phi'_{fd})$$

$$R_\tau = 6953.7 \frac{\text{lb}f}{\text{ft}} \qquad \text{Nominal sliding resistance Cohesionless Soils}$$

Compute factored resistance against failure by sliding LRFD [10.6.3.4]:

$$\phi_{ep} := 0.5$$

Resistance factor for passive resistance specified in LRFD Table 10.5.5.2.2-1

$$\phi_\tau := 1.0$$

Resistance factor for sliding resistance specified in LRFD Table 11.5.7-1.

$$\phi R_n := \phi_\tau \cdot R_\tau + \phi_{ep} \cdot R_{ep}$$

$$R_R := \phi R_n$$

Factored Sliding Resistance to be used in CDR Calculations:

$$R_R = 6953.714 \frac{\text{lb}f}{\text{ft}}$$

Sliding Capacity:Demand Ratio (CDR)

$$CDR_{Sliding} := \frac{R_R}{R_u}$$

Is the CDR > or = to 1.0?

$$CDR_{Sliding} = 1.61$$

Undrained Conditions (Total Stress):

Compute passive resistance throughout the design life of the wall LRFD [Eq 3.11.5.4-1]:

$$r_{ep1} := (k_{pu} \cdot \gamma_{fd} \cdot y_1 + 2 \cdot Su_{fd} \cdot \sqrt{k_{pu}}) \cdot \cos(\delta_{fd})$$

Nominal passive pressure at y1

$$r_{ep2} := (k_{pu} \cdot \gamma_{fd} \cdot y_2 + 2 \cdot Su_{fd} \cdot \sqrt{k_{pu}}) \cdot \cos(\delta_{fd})$$

Nominal passive pressure at y2

$$R_{ep} := \frac{r_{ep1} + r_{ep2}}{2} \cdot (y_2 - y_1) \quad R_{ep} = 0 \frac{lbf}{ft}$$

Nominal passive resistance Drained Conditions

416 Note: Passive Resistance shall be neglected in stability computations, unless the base of the wall extends below the depth of maximum scour, freeze-thaw or other disturbances. In the latter case, only the embedment below the greater of these depths shall be considered effective LRFD [11.6.3.5].

Compute sliding resistance between soil and foundation:

$$c := 1.0$$

c = 1.0 for Cast-in-Place
c = 0.8 for Precast

$$\Sigma V := V_{la} \quad \Sigma V = 14257.2 \frac{lbf}{ft}$$

Sum of Vertical Loads (Strength Ia)

$$e = 0.08 \text{ ft}$$

Wall eccentricity, Calculated in above Limiting Eccentricity at Base of Wall (Strength Ia) Section.

$$B = 10 \text{ ft}$$

Footing base width

$$\frac{B}{6} = 1.7 \text{ ft}$$

If e < B/6 the resultant is in the middle one-third

$$\sigma_{vmax} := \frac{\Sigma V}{B} \cdot \left(1 + 6 \cdot \frac{e}{B}\right) \quad \sigma_{vmax} = 1496.1 \frac{lbf}{ft^2}$$

Max vertical stress (if resultant is in the middle one-third of base) LRFD [11.6.3.2-2].

$$\sigma_{vmin} := \frac{\Sigma V}{B} \cdot \left(1 - 6 \cdot \frac{e}{B}\right) \quad \sigma_{vmin} = 1355.3 \frac{lbf}{ft^2}$$

Max vertical stress (if resultant is in the middle one-third of base) LRFD [11.6.3.2-2].

$$q_{max} := \frac{1}{2} \cdot \sigma_{vmax} \quad q_{max} = 748.1 \frac{lbf}{ft^2}$$

Max unit shear resistance as 1/2 max vertical stress LRFD [10.6.3.4].

$$q_{min} := \frac{1}{2} \cdot \sigma_{vmin} \quad q_{min} = 677.7 \frac{lbf}{ft^2}$$

Minimum unit shear resistance as 1/2 minimum vertical stress LRFD [10.6.3.4].

Determine which Cohesive Soil Resistance Case is Present:

$$Case_1 := \text{if}(q_{max} > Su_{fd} > q_{min} \geq 0, 1, 0) \quad Case_1 = 0$$

$$Case_2 := \text{if}(Su_{fd} > q_{max} > q_{min} \geq 0, 1, 0) \quad Case_2 = 1$$

$$Case_3 := \text{if}(q_{max} > q_{min} > Su_{fd}, 1, 0) \quad Case_3 = 0$$

$$Case_4 := \text{if}(q_{min} < 0, \text{if}(Su_{fd} < q_{max}, 1, 0), 0) \quad Case_4 = 0$$

$$Case_5 := \text{if}(q_{min} < 0, \text{if}(Su_{fd} > q_{max}, 1, 0), 0) \quad Case_5 = 0$$

Unit Shear Resistance for Case 1:

$$S_1 := Su_{fdu} - q_{min} = 1322.3 \frac{\text{lb}}{\text{ft}^2}$$

$$B_1 := \frac{B \cdot (Su_{fdu} - q_{min})}{q_{max} - q_{min}} = 187.8 \text{ ft}$$

$$B_3 := B = 10 \text{ ft}$$

$$I := \frac{1}{2} \cdot S_1 \cdot B_1 = 124175 \frac{\text{lb}}{\text{ft}}$$

$$III := S_2 \cdot B_3 = 6776.6 \frac{\text{lb}}{\text{ft}}$$

$$R_{\tau_{case1}} := I + II + III = -104175 \frac{\text{lb}}{\text{ft}}$$

$$S_2 := q_{min} = 677.7 \frac{\text{lb}}{\text{ft}^2}$$

$$B_2 := \frac{B \cdot (q_{max} - Su_{fdu})}{q_{max} - q_{min}} = -177.8 \text{ ft}$$

$$II := S_1 \cdot B_2 = -235126.6 \frac{\text{lb}}{\text{ft}}$$

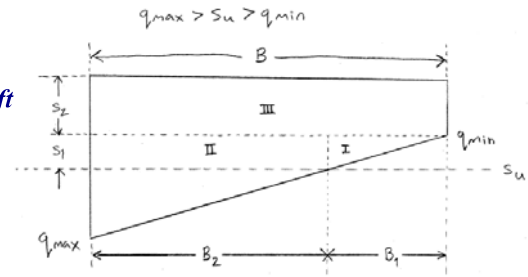

Unit Shear Resistance for Case 2:

$$S_1 := q_{max} - q_{min} = 70.4 \frac{\text{lb}}{\text{ft}^2}$$

$$B = 10 \text{ ft}$$

$$I := \frac{1}{2} \cdot S_1 \cdot B = 352 \frac{\text{lb}}{\text{ft}}$$

$$R_{\tau_{case2}} := I + II = 7128.6 \frac{\text{lb}}{\text{ft}}$$

$$S_2 := q_{min} = 677.7 \frac{\text{lb}}{\text{ft}^2}$$

$$II := S_2 \cdot B = 6776.6 \frac{\text{lb}}{\text{ft}}$$

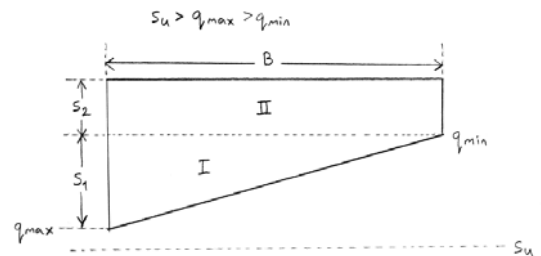

Unit Shear Resistance for Case 3:

$$S_1 := Su_{fdu} = 2000 \frac{\text{lb}}{\text{ft}^2}$$

$$B = 10 \text{ ft}$$

$$I := \frac{1}{2} \cdot S_1 \cdot B = 10000 \frac{\text{lb}}{\text{ft}}$$

$$R_{\tau_{case3}} := I = 10000 \frac{\text{lb}}{\text{ft}}$$

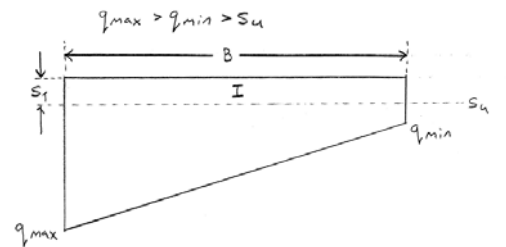

Unit Shear Resistance for Case 4:

$$S_1 := Su_{fdu} = 2000 \frac{\text{lb}}{\text{ft}^2}$$

$$B_3 := \frac{B \cdot (-q_{min})}{q_{max} - q_{min}} = -96.2 \text{ ft}$$

$$B_2 := B - (B_1 + B_3) = -177.8 \text{ ft}$$

$$I := \frac{1}{2} \cdot S_1 \cdot B_1 = 284057.4 \frac{\text{lb}}{\text{ft}}$$

$$R_{\tau_{case4}} := I + II = -71563.9 \frac{\text{lb}}{\text{ft}}$$

$$B_1 := \left(\frac{Su_{fdu}}{q_{max}} \right) \cdot (B - B_3) = 284.1 \text{ ft}$$

$$II := S_1 \cdot B_2 = -355621.3 \frac{\text{lb}}{\text{ft}}$$

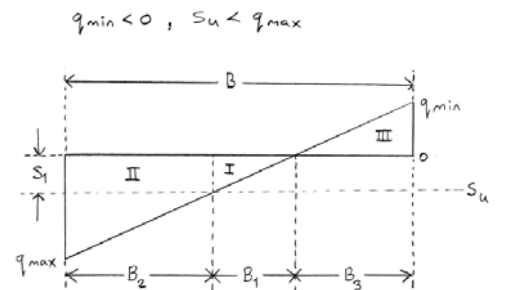

Unit Shear Resistance for Case 5:

$$S_1 := q_{max} = 748.1 \frac{\text{lb}}{\text{ft}^2}$$

$$B_1 := \frac{B \cdot q_{max}}{q_{max} - q_{min}} = 106.2 \text{ ft}$$

$$B_2 := B - B_1 = -96.2 \text{ ft}$$

$$I := \frac{1}{2} \cdot S_1 \cdot B_1 = 39739.8 \frac{\text{lb}}{\text{ft}}$$

$$R_{\tau_{case5}} := I = 39739.8 \frac{\text{lb}}{\text{ft}}$$

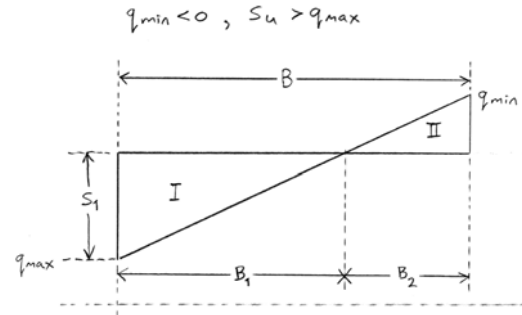

Define the Applicable Case:

$$R_{\tau} := R_{\tau_{case2}}$$

$$R_{\tau} = 7128.6 \frac{\text{lb}}{\text{ft}}$$

Nominal sliding resistance Cohesive Soils

Compute factored resistance against failure by sliding **LRFD [10.6.3.4]:**

$$\phi_{ep} := 0.5$$

Resistance factor for passive resistance specified in **LRFD Table 10.5.5.2.2-1**

$$\phi_{\tau} := 1.0$$

Resistance factor for sliding resistance specified in **LRFD Table 11.5.7-1.**

$$\phi R_n := \phi_{\tau} \cdot R_{\tau} + \phi_{ep} \cdot R_{ep}$$

$$R_R := \phi R_n$$

Factored Sliding Resistance to be used in CDR Calculations:

$$R_R = 7128.613 \frac{\text{lb}}{\text{ft}}$$

Sliding Capacity: Demand Ratio (CDR)

$$CDR_{Sliding} := \frac{R_R}{R_u}$$

Is the CDR > or = to 1.0?

$$CDR_{Sliding} = 1.65$$

APPENDIX 3C
GLOBAL STABILITY ANALYSIS

RETAINING WALL 1 – TALLEST HEIGHT SECTION

Material Name	Color	Unit Weight (lbs/ft ³)	Saturated U.W. (lbs/ft ³)	Cohesion (psf)	Phi (°)
Proposed CIP Wall		150		576000	0
Proposed Embankment Fill		120		0	30
Soil Type 1 - Effective		125	125	205	22
Soil Type 2 - Effective		120	130	0	39

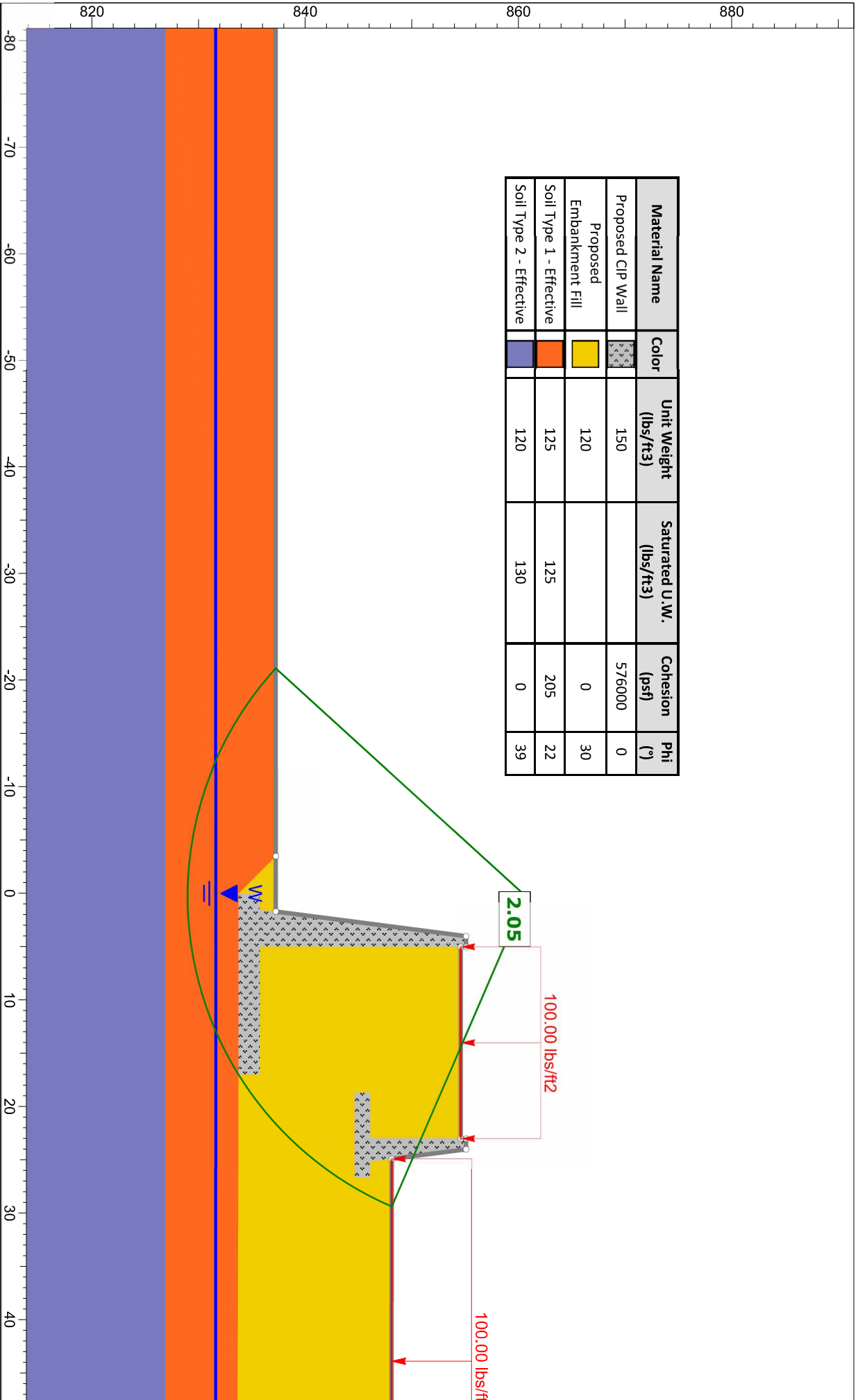

GER-68-12.65, PID 115388

Project: Effective Stress

Group: Effective Stress

Drawn By: KCA

Date: 1/22/2025, 12:05:02 PM

Scenario: Effective - Circular

Company: NEAS Inc.

File Name: RW1_GlobalEffective_012225.slm.d

SLIDE/INTERPRET 9.034

Material Name	Color	Unit Weight (lbs/ft ³)	Saturated U.W. (lbs/ft ³)	Cohesion (psf)	Phi (°)
Proposed CIP Wall		150		576000	0
Proposed Embankment Fill		120		0	30
Soil Type 1 - Effective		125	125	205	22
Soil Type 2 - Effective		120	130	0	39

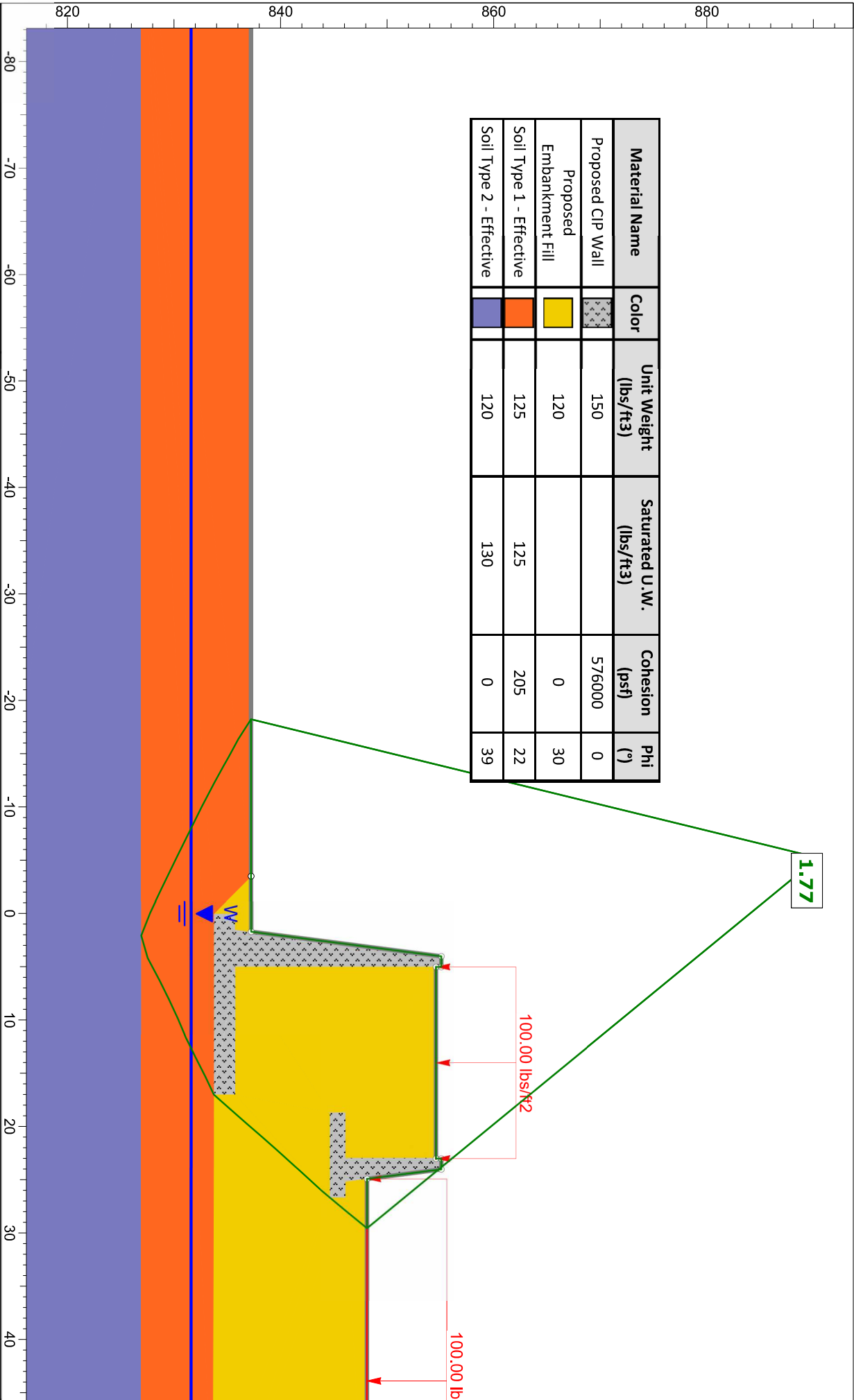

GER-68-12.65, PID 115388



SLIDENINTERPRET 9.034

Project		Scenario	
GER-68-12.65, PID 115388		Effective - Non-Circular	
Group	Effective Stress	Company	NEAS Inc.
Drawn By	KCA	File Name	RW1_GlobalEffective_012225.slmtd
Date	1/22/2025, 12:05:02 PM		

Material Name	Color	Unit Weight (lbs/ft ³)	Saturated U.W. (lbs/ft ³)	Cohesion (psf)	Phi (°)
Proposed CIP Wall		150		576000	0
Proposed Embankment Fill		120		0	30
Soil Type 1 - Total		125	125	2100	0
Soil Type 2 - Total		120	130	0	39

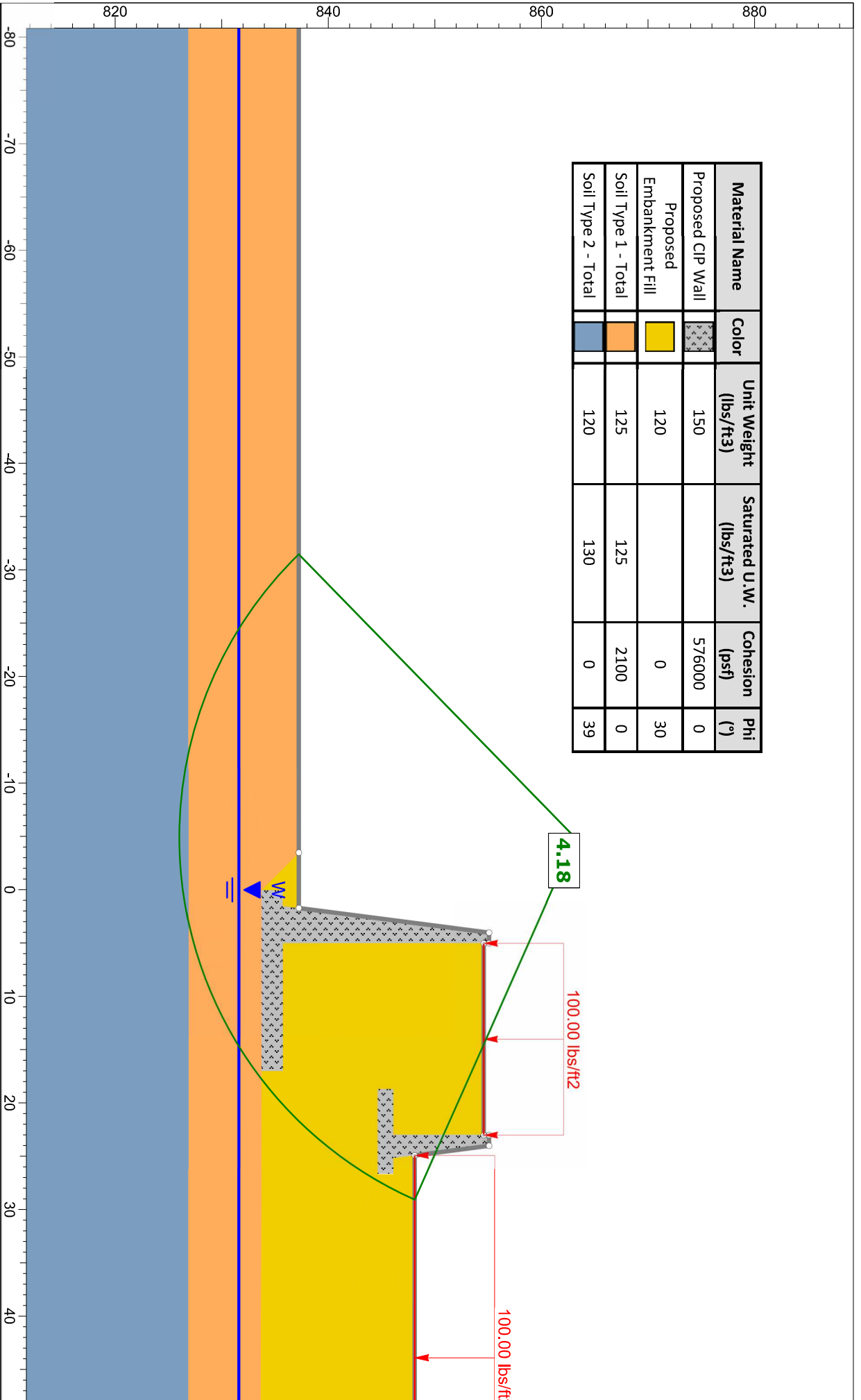

GER-68-12.65, PID 115388

Project		Global Stability - RW-1		Scenario		Total Stress - Circular	
Drawn By		KCA		Company		NEAS Inc.	
Date		1/22/2025, 12:05:02 PM		File Name		RW1_Global_012225.slmd	



Material Name	Color	Unit Weight (lbs/ft ³)	Saturated U.W. (lbs/ft ³)	Cohesion (psf)	Phi (°)
Proposed CIP Wall		150		576000	0
Proposed Embankment Fill		120		0	30
Soil Type 1 - Total		125	125	2100	0
Soil Type 2 - Total		120	130	0	39

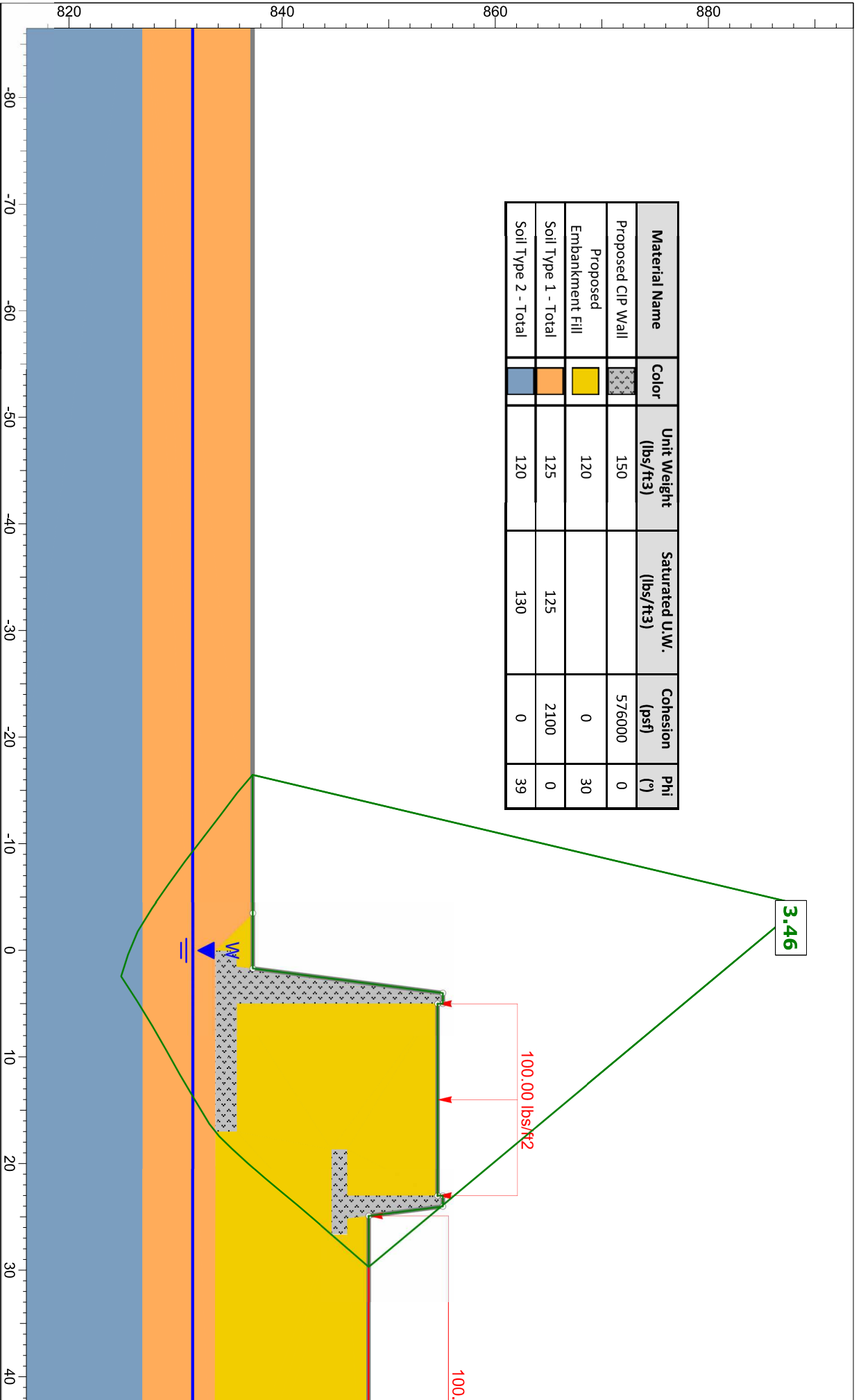

Project GER-68-12.65, PID 115388

Group	Scenario
Effective - Non-Circular	Total - Non-Circular
Drawn By KCA	Company NEAS Inc.
Date 1/22/2025, 12:05:02 PM	File Name RW1_Global_012225.slmd



RETAINING WALL 3 – TALLEST HEIGHT SECTION

Material Name	Color	Unit Weight (lbs/ft ³)	Saturated U.W. (lbs/ft ³)	Cohesion (psf)	Phi (°)
Proposed CIP Wall		150		576000	0
Proposed Embankment Fill		120		0	30
Soil Type 1 - Effective		125		205	22
Soil Type 2 - Effective		120		0	39

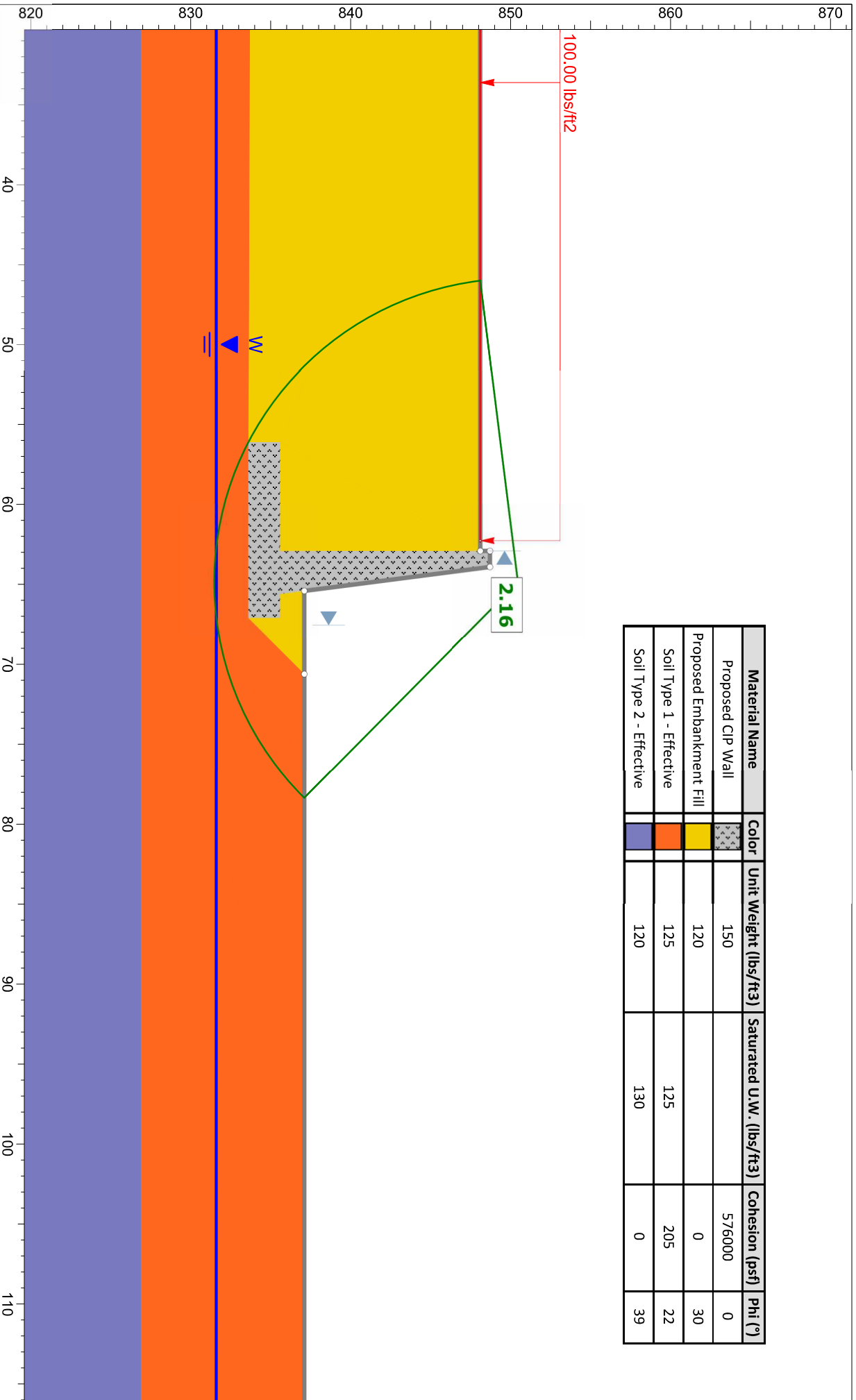

Project GER-68-12.65, PID 115388



SLIDEINTERPRET 9.034

<i>Group</i>	Effective Stress
<i>Drawn By</i>	KCA
<i>Date</i>	1/22/2025, 12:05:02 PM
<i>Scenario</i>	Effective - Circular
<i>Company</i>	NEAS Inc.
<i>File Name</i>	RW3_GlobalEffective_021525.slmd

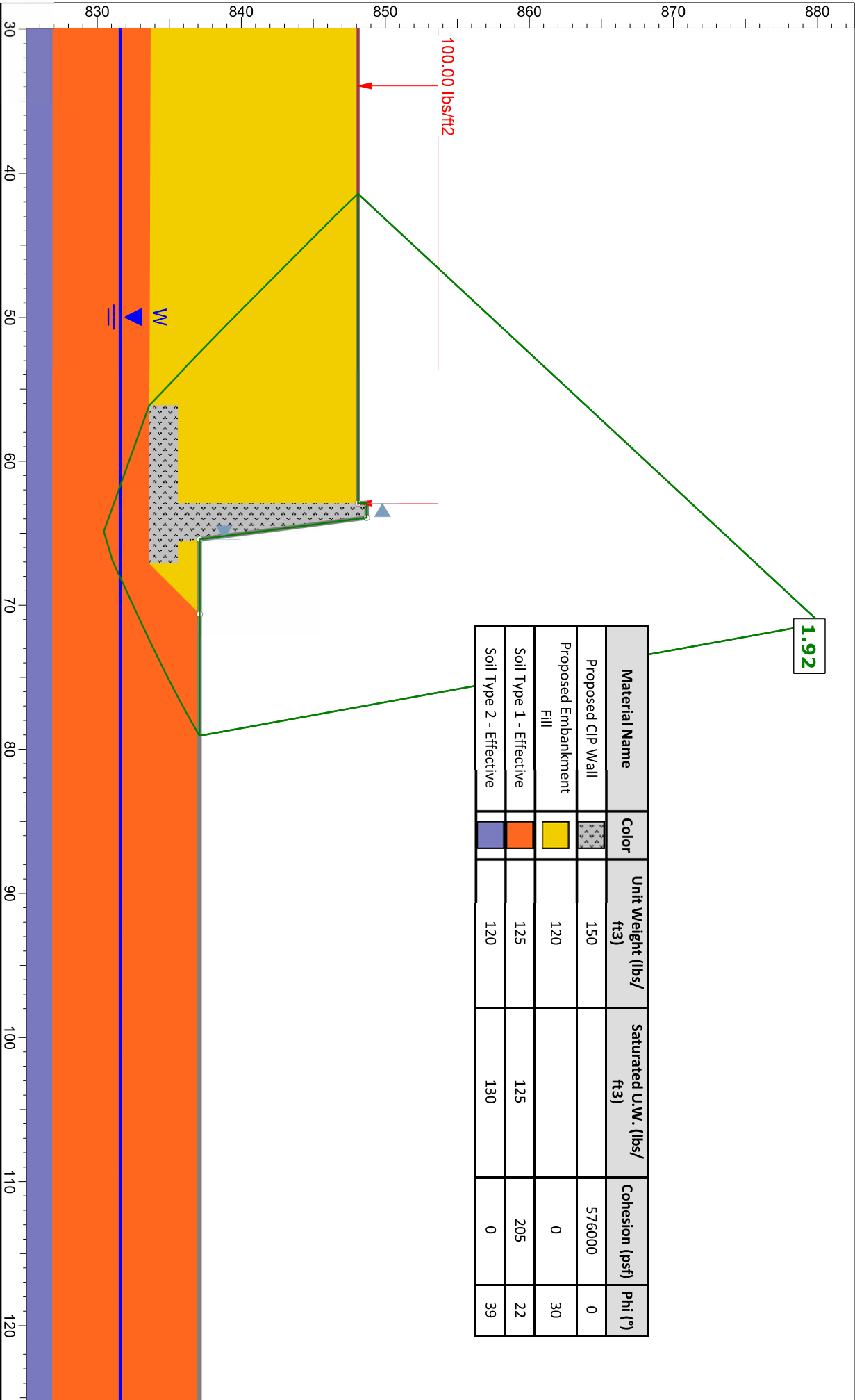





Material Name	Color	Unit Weight (lbs/ft ³)	Saturated U.W. (lbs/ft ³)	Cohesion (psf)	Phi (°)
Proposed CIP Wall		150		576000	0
Proposed Embankment Fill		120		0	30
Soil Type 1 - Effective		125	125	205	22
Soil Type 2 - Effective		120	130	0	39



Project: GER-68-12.65, PID 115388

Group	Effective Stress	Scenario	Effective - Non-Circular
Drawn By	KCA	Company	NEAS Inc.
Date	1/22/2025, 12:05:02 PM	File Name	RW3_GlobalEffective_021525.slmtd

Material Name	Color	Unit Weight (lbs/ft ³)	Saturated U.W. (lbs/ft ³)	Cohesion (psf)	Phi (°)
Proposed CIP Wall		150		576000	0
Proposed Embankment Fill		120		0	30
Soil Type 1 - Total		125	125	2100	0
Soil Type 2 - Total		120	130	0	39

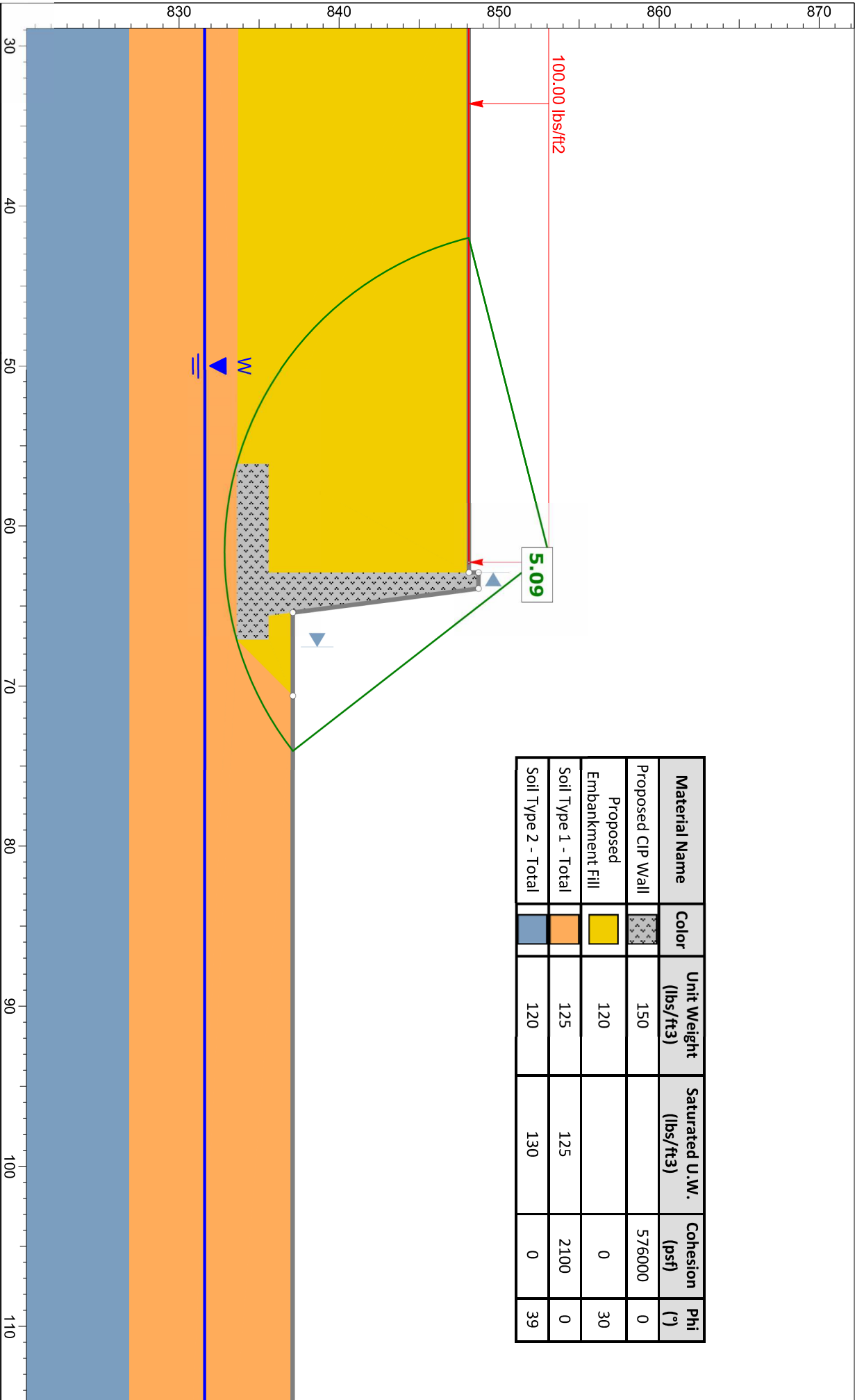

Project GER-68-12.65, PID 115388

	
Group	Total Stress
Drawn By	KCA
Date	1/22/2025, 12:05:02 PM
Scenario	Total - Circular
Company	NEAS Inc.
File Name	RW3_GlobalTotal_021525.slmnd

Material Name	Color	Unit Weight (lbs/ft ³)	Saturated U.W. (lbs/ft ³)	Cohesion (psf)	Phi (°)
Proposed CIP Wall		150		576000	0
Proposed Embankment Fill		120		0	30
Soil Type 1 - Total		125		2100	0
Soil Type 2 - Total		120	130	0	39

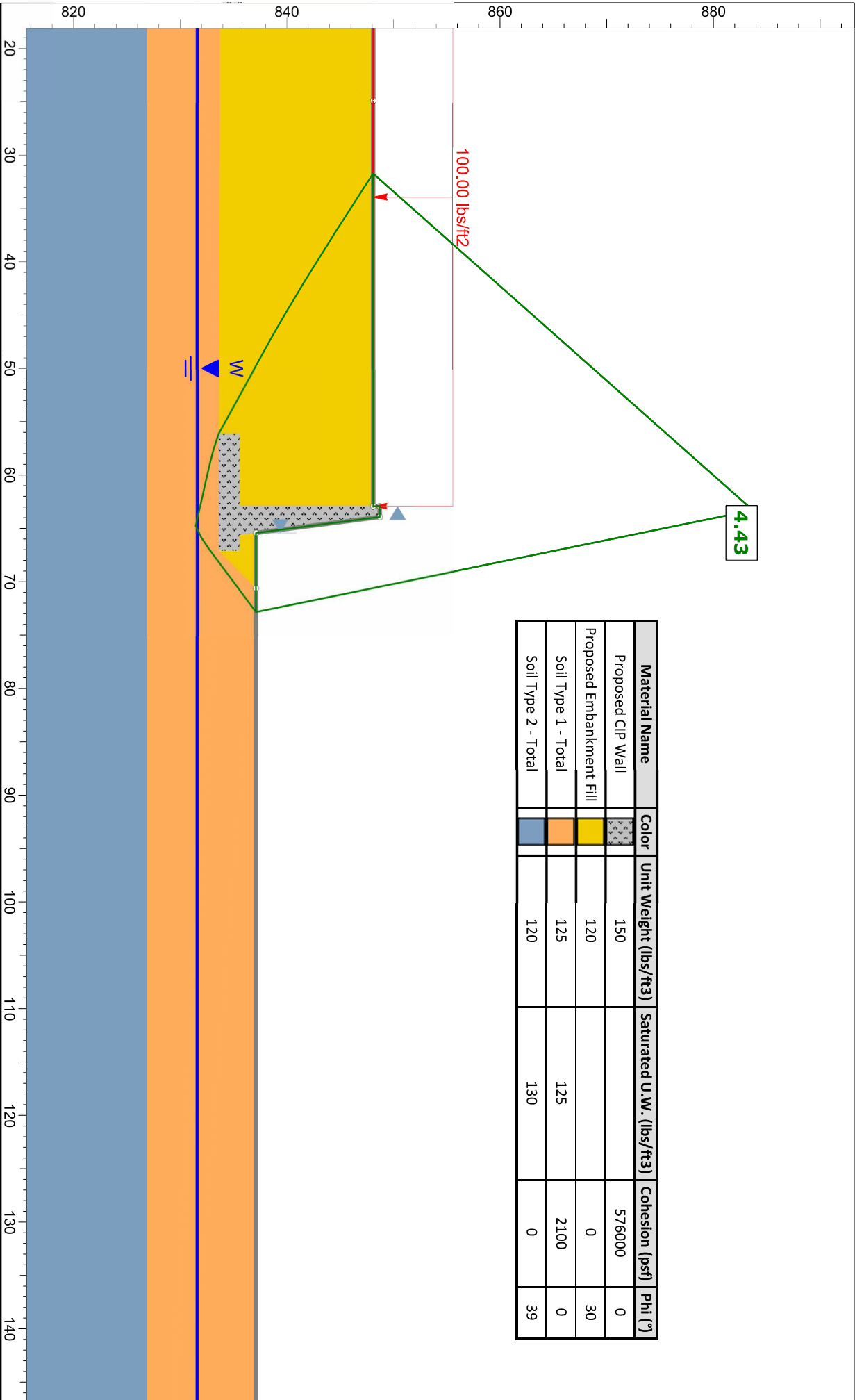

GER-68-12.65, PID 115388

Project

Group

Total Stress

Scenario

Total - Non-Circular

Drawn By

KCA

Company

NEAS Inc.

Date

1/22/2025, 12:05:02 PM

File Name

RW3_GlobalTotal_021525.slmnd



APPENDIX 3D

SETTLEMENT ANALYSIS



GRE-68-12.65 (PID 115388)

NEAS Inc.

Report Creation Date: 2025/02/17, 15:25:53

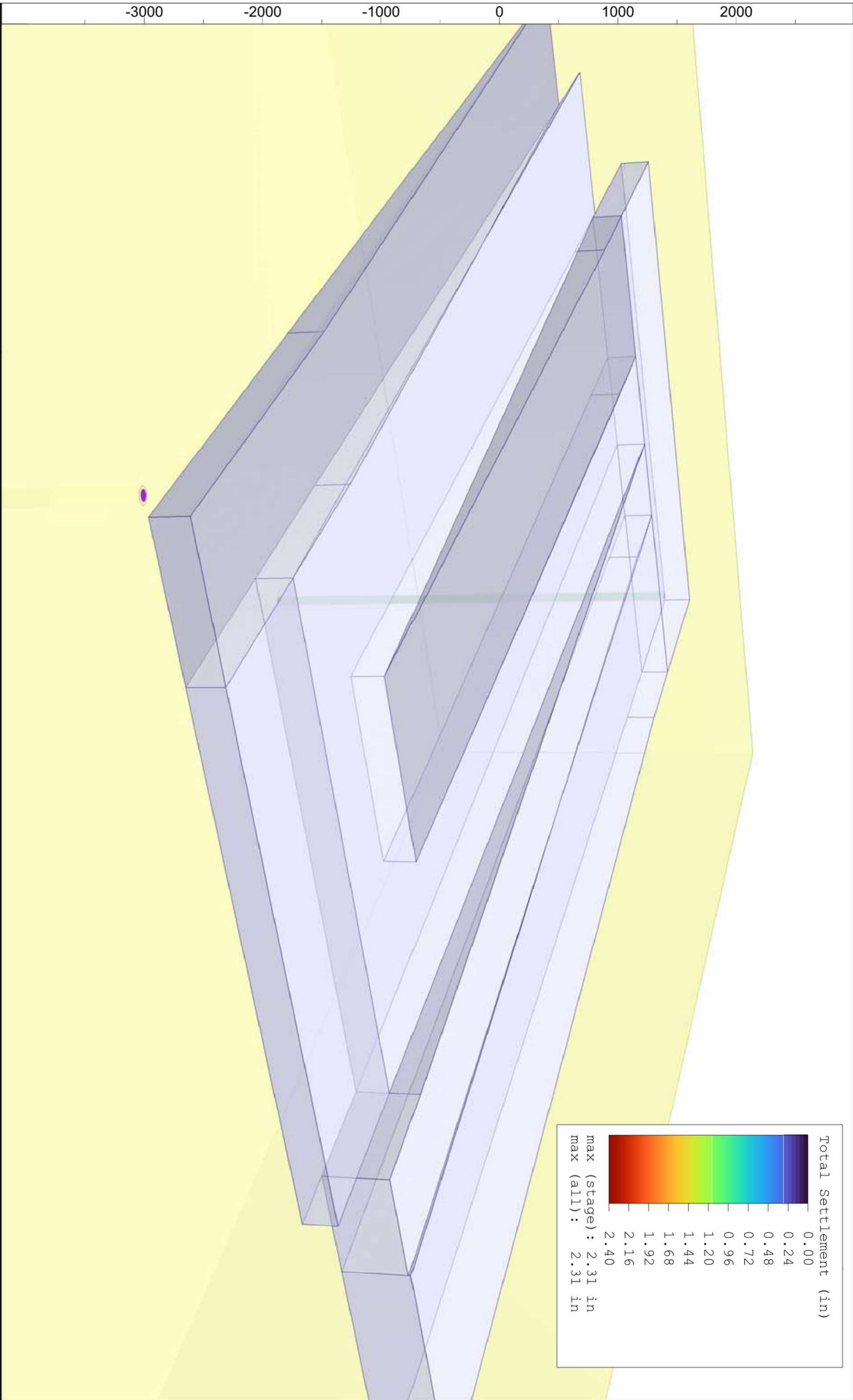

-3000 -2000 -1000 0 1000 2000



SETTLES3 5.024

Project

GRE-68-12.65 (PID 115388)

Analysis Description

Settlement Analysis of Project Retaining Walls

Drawn By

KCA

Company

NEAS Inc.

Date

1/23/2025, 4:01:51 PM

File Name

GRE-68-12.65_RW_Settle012425.s3z

Table of Contents

Project Settings	3
Advanced Settings	3
Soil Profile	3
Stage Settings	4
Results	5
Stage: Stage 1 = 0 d	5
Stage: Stage 2 = 30 d	5
Stage: Stage 3 = 20000 d	6
Loads	8
1. Polygonal Load: "Embankment Load 1"	8
Coordinates and Load	8
2. Polygonal Load: "Embankment Load 2"	8
3. Polygonal Load: "Retaining Wall 5"	8
4. Polygonal Load: "Retaining Wall 4"	9
5. Polygonal Load: "Retaining Wall 1"	9
6. Polygonal Load: "Retaining Wall 2"	9
7. Polygonal Load: "Retaining Wall 3"	10
Soil Layers	11
B-001-2-24	11
B-001-3-24	11
B-001-1-24	11
B-001-0-23	12
Soil Properties	13
Groundwater	14
Query	15
Query Points	15
Query Lines	15

Settle3 Analysis Information

GRE-68-12.65 (PID 115388)

Project Settings

Document Name	GRE-68-12.65_RW_Settle012425.s3z
Project Title	GRE-68-12.65 (PID 115388)
Analysis	Settlement Analysis of Project Retaining Walls
Author	KCA
Company	NEAS Inc.
Date Created	1/23/2025, 4:01:51 PM
Last saved with Settle3 version	5.024
Stress Computation Method	Boussinesq
Stress Units	Imperial, stress as ksf
Settlement Units	inches
Time-dependent Consolidation Analysis	
Time Units	days
Permeability Units	feet/day

Advanced Settings

Start of secondary consolidation (% of primary)	95
Min. stress for secondary consolidation (% of initial)	1
Reset time when load changes for secondary consolidation	No
Minimum settlement ratio for subgrade modulus	0.9
Use average poisson's ratio to calculate layered stresses	
Update Cv in each time step (improves consolidation accuracy)	
Ignore negative effective stresses in settlement calculations	
Add field points to load edges	

Soil Profile

Layer Option	Non-Horizontal Layers
Interpolation Method	Thin-Plate Spline
Use Non-Horizontal Ground Surface	No
Vertical Axis	Elevation
Ground Elevation (ft)	833.7

Stage Settings

Stage #	Name	Time [days]
1	Stage 1	0
2	Stage 2	30
3	Stage 3	20000

Results

Time taken to compute: 0.0011853 seconds

Stage: Stage 1 = 0 d

Data Type	Minimum	Maximum
Total Settlement [in]	0	0.850205
Total Consolidation Settlement [in]	0	0
Virgin Consolidation Settlement [in]	0	0
Recompression Consolidation Settlement [in]	0	0
Immediate Settlement [in]	0	0.850205
Secondary Settlement [in]	0	0
Loading Stress ZZ [ksf]	-5.8019e-06	2.01623
Loading Stress XX [ksf]	-0.425171	1.39723
Loading Stress YY [ksf]	-0.0756113	1.53023
Effective Stress ZZ [ksf]	0	5.1996
Effective Stress XX [ksf]	-0.425171	5.51873
Effective Stress YY [ksf]	-0.0756113	5.3733
Total Stress ZZ [ksf]	-5.8019e-06	6.05104
Total Stress XX [ksf]	-0.425177	6.17224
Total Stress YY [ksf]	-0.0756113	6.22181
Modulus of Subgrade Reaction (Total) [ksf/ft]	-0.000178286	39.7256
Modulus of Subgrade Reaction (Immediate) [ksf/ft]	-0.000178286	39.7256
Modulus of Subgrade Reaction (Consolidation) [ksf/ft]	0	0
Total Strain	1.89241e-07	0.00271879
Pore Water Pressure [ksf]	-5.8019e-06	2.01623
Excess Pore Water Pressure [ksf]	-5.8019e-06	2.01623
Degree of Consolidation [%]	0	0
Pre-consolidation Stress [ksf]	0.00300918	5.197
Over-consolidation Ratio	1	6
Void Ratio	0	0.707
Permeability [ft/d]	0	0.0164789
Coefficient of Consolidation [ft ² /d]	0	0.04
Hydroconsolidation Settlement [in]	0	0
Average Degree of Consolidation [%]	0	10
Undrained Shear Strength	-2.22045e-16	1.11022e-16

Stage: Stage 2 = 30 d

Data Type	Minimum	Maximum
Total Settlement [in]	0	2.13514
Total Consolidation Settlement [in]	0	1.37365
Virgin Consolidation Settlement [in]	0	1.21208
Recompression Consolidation Settlement [in]	0	0.185925
Immediate Settlement [in]	0	0.850205
Secondary Settlement [in]	0	0
Loading Stress ZZ [ksf]	-5.8019e-06	2.01623
Loading Stress XX [ksf]	-0.425171	1.39723
Loading Stress YY [ksf]	-0.0756113	1.53023
Effective Stress ZZ [ksf]	0	5.99518
Effective Stress XX [ksf]	-0.425177	6.01648
Effective Stress YY [ksf]	-0.0756113	6.11594
Total Stress ZZ [ksf]	0	6.05104
Total Stress XX [ksf]	-0.425177	6.17224
Total Stress YY [ksf]	-0.0756113	6.22181
Modulus of Subgrade Reaction (Total) [ksf/ft]	-0.000163532	28.2061
Modulus of Subgrade Reaction (Immediate) [ksf/ft]	-0.000178286	39.7256
Modulus of Subgrade Reaction (Consolidation) [ksf/ft]	-0.00197619	89.7906
Total Strain	-7.35415e-05	0.262513
Pore Water Pressure [ksf]	-1.4727e-25	0.874574
Excess Pore Water Pressure [ksf]	-1.4727e-25	0.874574
Degree of Consolidation [%]	0	100
Pre-consolidation Stress [ksf]	0.0249323	5.99296
Over-consolidation Ratio	1	6.13734
Void Ratio	0	0.707126
Permeability [ft/d]	0	0.210423
Coefficient of Consolidation [ft ² /d]	0	0.04
Hydroconsolidation Settlement [in]	0	0
Average Degree of Consolidation [%]	0	100
Undrained Shear Strength	-0.00125225	0.100393

Stage: Stage 3 = 20000 d

Data Type	Minimum	Maximum
Total Settlement [in]	0	2.31046
Total Consolidation Settlement [in]	0	1.54881
Virgin Consolidation Settlement [in]	0	1.36487
Recompression Consolidation Settlement [in]	0	0.245806
Immediate Settlement [in]	0	0.850205
Secondary Settlement [in]	0	0
Loading Stress ZZ [ksf]	-5.8019e-06	2.01623
Loading Stress XX [ksf]	-0.425171	1.39723
Loading Stress YY [ksf]	-0.0756113	1.53023
Effective Stress ZZ [ksf]	0	6.05104
Effective Stress XX [ksf]	-0.425177	6.17224
Effective Stress YY [ksf]	-0.0756113	6.22181
Total Stress ZZ [ksf]	0	6.05104
Total Stress XX [ksf]	-0.425177	6.17224
Total Stress YY [ksf]	-0.0756113	6.22181
Modulus of Subgrade Reaction (Total) [ksf/ft]	-0.000155818	28.2061
Modulus of Subgrade Reaction (Immediate) [ksf/ft]	-0.000178286	39.7256
Modulus of Subgrade Reaction (Consolidation) [ksf/ft]	-0.00123646	89.7906
Total Strain	4.44947e-06	0.262513
Pore Water Pressure [ksf]	-5.11007e-19	2.44068e-19
Excess Pore Water Pressure [ksf]	-5.11007e-19	2.44068e-19
Degree of Consolidation [%]	0	100
Pre-consolidation Stress [ksf]	0.0249323	6.04888
Over-consolidation Ratio	1	5.79189
Void Ratio	0	0.7068
Permeability [ft/d]	0	0.210423
Coefficient of Consolidation [ft ² /d]	0	0.04
Hydroconsolidation Settlement [in]	0	0
Average Degree of Consolidation [%]	0	100
Undrained Shear Strength	0	0.122893

Loads

1. Polygonal Load: "Embankment Load 1"

Label	Embankment Load 1
Load Type	Flexible
Area of Load	2082.61 ft ²
Elevation	833.7 ft
Installation Stage	Stage 1 = 0 d

Coordinates and Load

X [ft]	Y [ft]	Load Magnitude [ksf]
11	20	0
11	7.6	0
103.9	7.6	1.02
103.9	41.5	1.02
12	41.5	1.26
12	33	1.26
92.4	33	1.02
92.4	20	1.02

2. Polygonal Load: "Embankment Load 2"

Label	Embankment Load 2
Load Type	Flexible
Area of Load	714.96 ft ²
Elevation	833.7 ft
Installation Stage	Stage 1 = 0 d

Coordinates and Load

X [ft]	Y [ft]	Load Magnitude [ksf]
103.9	41.5	1.96
111.3	41.5	1.99
111.3	48.7	1.99
12	48.7	1.26
12	41.5	1.26

3. Polygonal Load: "Retaining Wall 5"

Label	Retaining Wall 5
Load Type	Flexible
Area of Load	853.2 ft ²
Elevation	833.7 ft
Installation Stage	Stage 1 = 0 d

Coordinates and Load

X [ft]	Y [ft]	Load Magnitude [ksf]
20.4	-1.4	0
92.7	-1.4	1.02
115.2	-1.4	1.02
115.2	7.6	1.02
92.7	7.6	1.02
20.4	7.6	0

4. Polygonal Load: "Retaining Wall 4"

Label	Retaining Wall 4
Load Type	Flexible
Area of Load	383.07 ft2
Elevation	833.7 ft
Installation Stage	Stage 1 = 0 d

Coordinates and Load

X [ft]	Y [ft]	Load Magnitude [ksf]
115.2	7.6	1.02
115.2	41.5	1.02
103.9	41.5	1.02
103.9	7.6	1.02

5. Polygonal Load: "Retaining Wall 1"

Label	Retaining Wall 1
Load Type	Flexible
Area of Load	1658.31 ft2
Elevation	833.7 ft
Installation Stage	Stage 1 = 0 d

Coordinates and Load

X [ft]	Y [ft]	Load Magnitude [ksf]
12	65.4	1.26
12	48.7	1.26
20.5	48.7	1.26
111.3	48.7	2.06
111.3	65.4	2.06
20.5	65.4	1.26

6. Polygonal Load: "Retaining Wall 2"

Label	Retaining Wall 2
Load Type	Flexible
Area of Load	676.46 ft2
Elevation	833.7 ft
Installation Stage	Stage 1 = 0 d

Coordinates and Load

X [ft]	Y [ft]	Load Magnitude [ksf]
-2.9	20	1.26
12	20	1.26
12	65.4	1.26
-2.9	65.4	1.26

7. Polygonal Load: "Retaining Wall 3"

Label	Retaining Wall 3
Load Type	Flexible
Area of Load	1045.2 ft2
Elevation	833.7 ft
Installation Stage	Stage 1 = 0 d

Coordinates and Load

X [ft]	Y [ft]	Load Magnitude [ksf]
12	20	1.26
20.5	20	1.26
92.4	20	1.02
92.4	33	1.02
20.5	33	1.26
12	33	1.26

Soil Layers

Ground Surface Drained: Yes

B-001-2-24

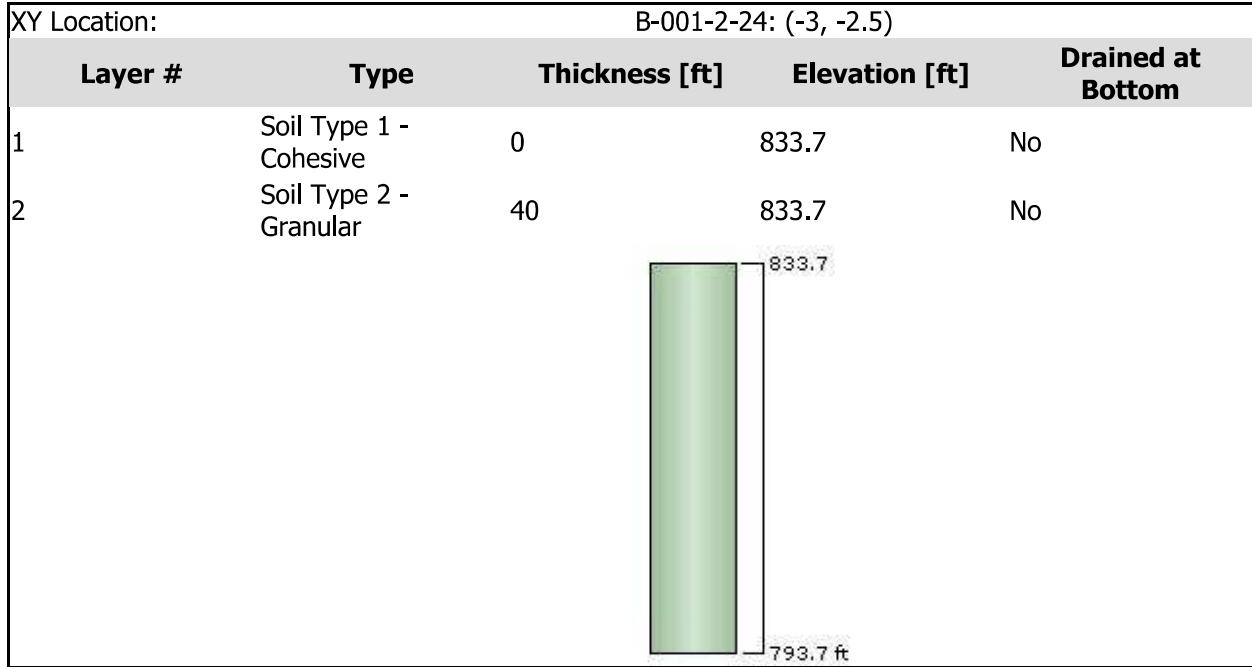

B-001-3-24

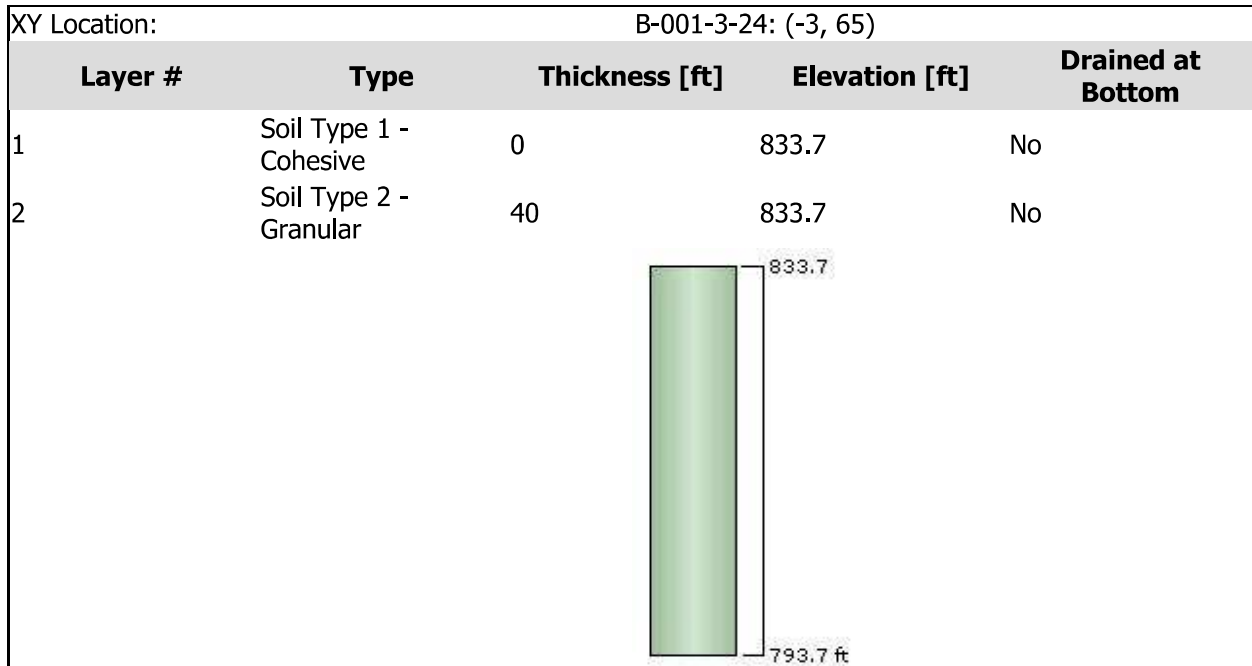

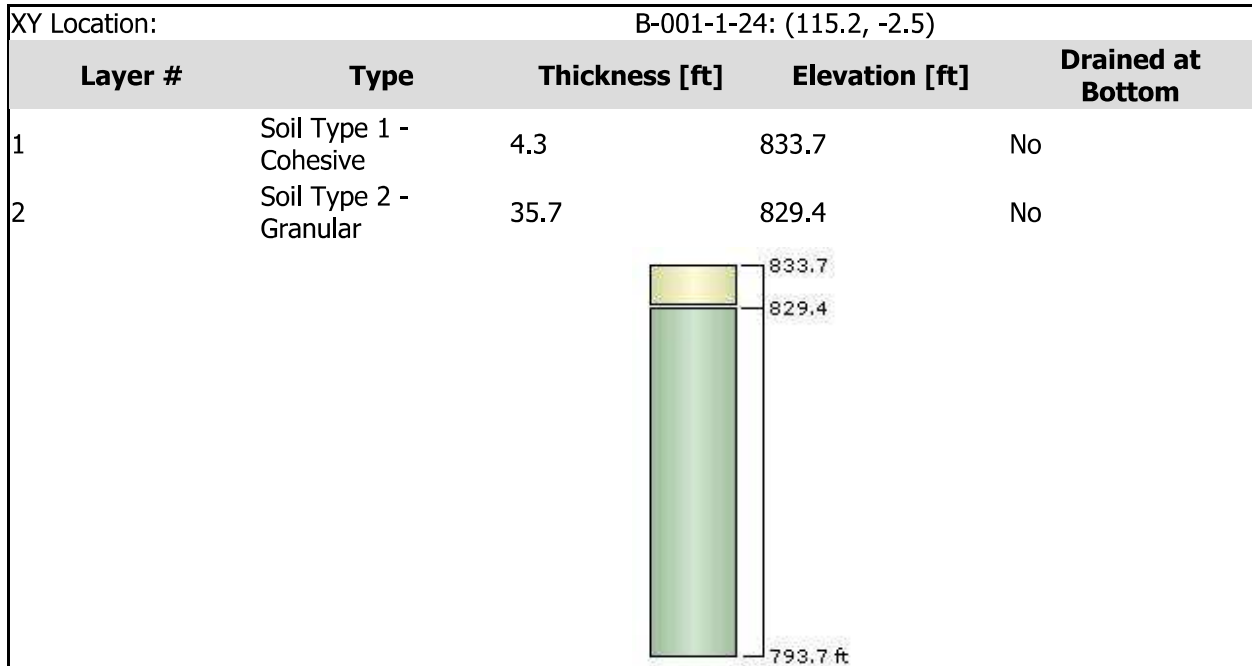

B-001-1-24

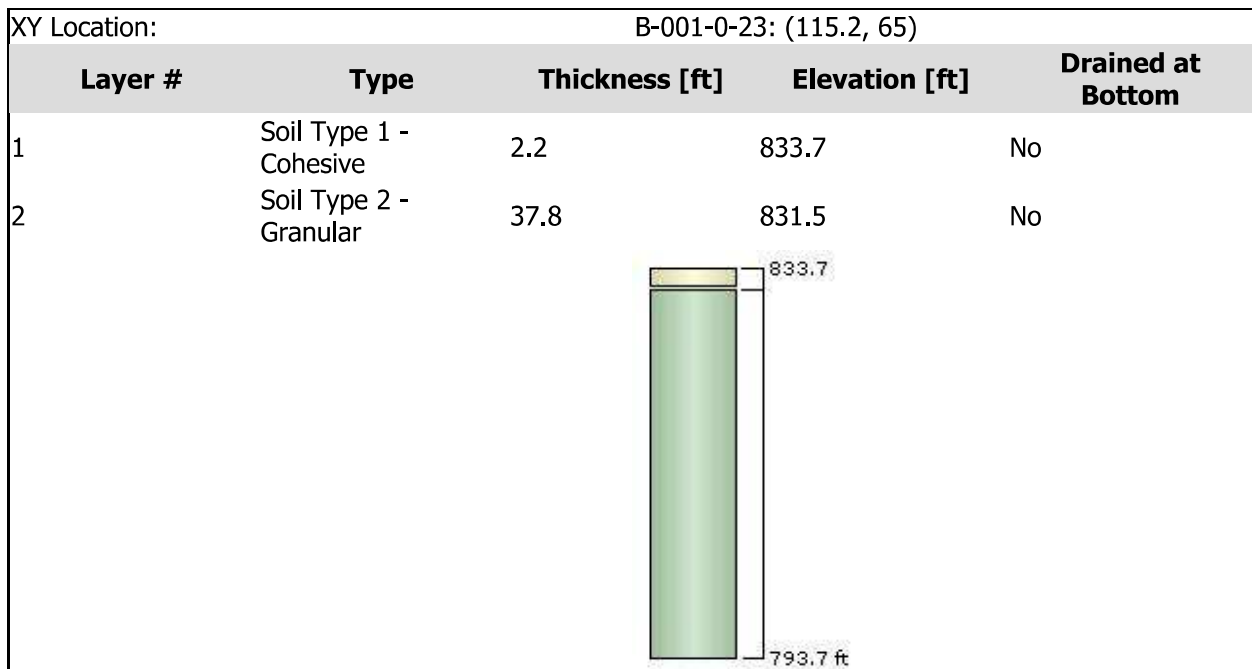

B-001-0-23



Soil Properties

Property	Soil Type 1 - Cohesive	Soil Type 2 - Granular
Color		
Unit Weight [kips/ft3]	0.125	0.13
Saturated Unit Weight [kips/ft3]	0.13	0.13
K0	1	1
Immediate Settlement	Enabled	Enabled
Es [ksf]	789	726
Esur [ksf]	789	726
Primary Consolidation	Enabled	Disabled
Material Type	Non-Linear	
Cc	0.166	-
Cr	0.013	-
e0	0.707	-
OCR	6	-
Cv [ft2/d]	0.04	-
Cvr [ft2/d]	0.04	-
B-bar	1	-
Undrained Su A [kips/ft2]	0	0
Undrained Su S	0.2	0.2
Undrained Su m	0.8	0.8
Piezo Line ID	0	0

Groundwater

Groundwater method

Water Unit Weight

Generating excess pore pressure above water table

Piezometric Lines

0.0624 kips/ft³

Query

Query Points

Point #	Query Point Name	(X,Y) Location	Number of Divisions
1	Query Point 1	112.831, 50.2	Auto: 37

Query Lines

Line #	Query Line Name	Start Location	End Location	Horizontal Divisions	Vertical Divisions
8	Query Line 8	111.3, 57.2171	12, 57.2171	20	Auto: 37
9	Query Line 9	4.54974, 65.4	4.54974, 20	20	Auto: 37
10	Query Line 10	12, 26.5002	92.4, 26.5002	20	Auto: 37
11	Query Line 11	109.55, 41.5	109.55, 7.6	20	Auto: 37
12	Query Line 12	115.2, 3.09983	20.4, 3.09983	20	Auto: 41
13	Query Line 13	20.5, 44.9	111.3, 44.9	20	Auto: 37

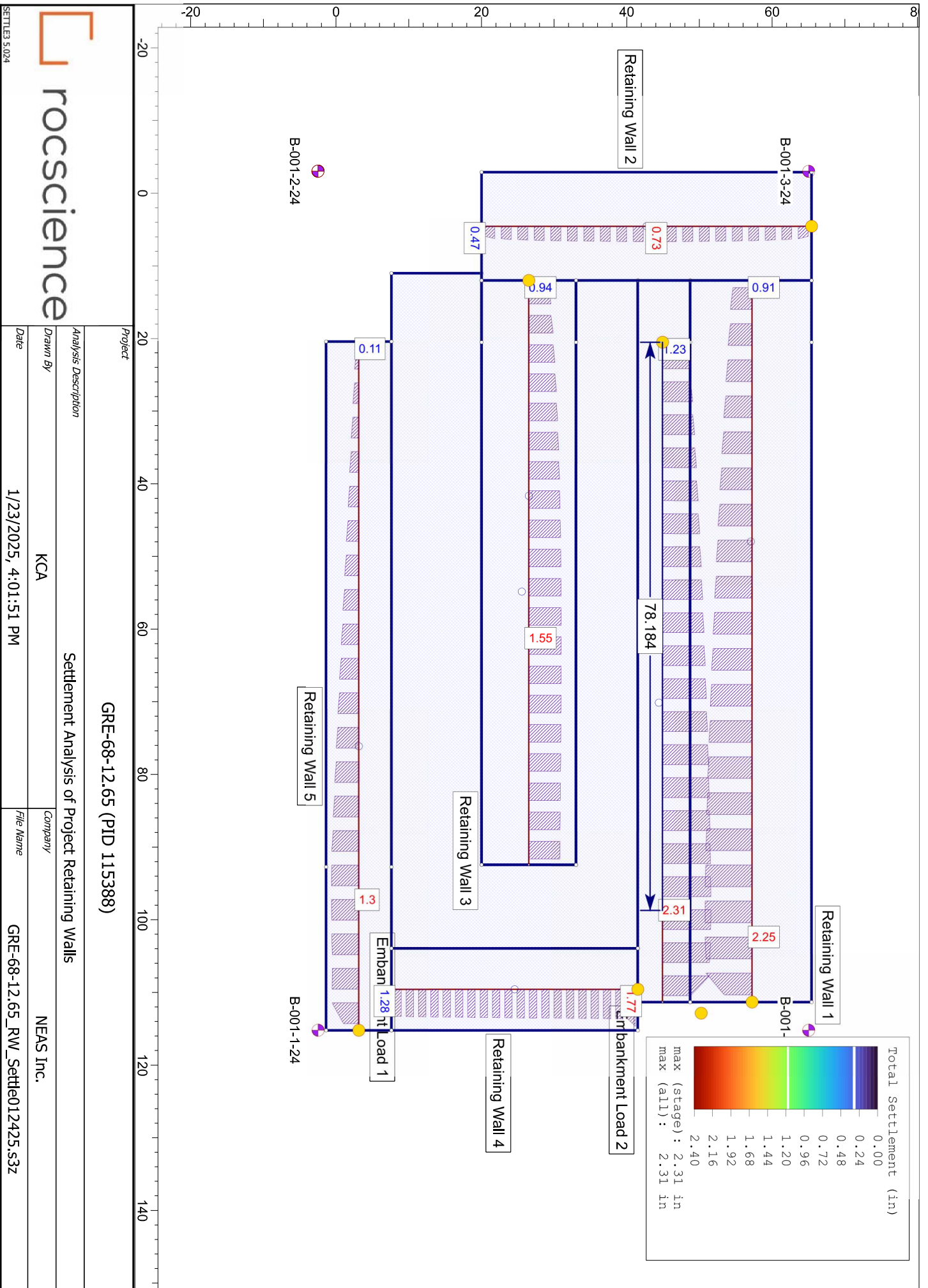

SETTLES3 5.024

Project		GRE-68-12.65 (PID 115388)	
Analysis Description		Settlement Analysis of Project Retaining Walls	
Drawn By	KCA	Company	NEAS Inc.
Date	1/23/2025, 4:01:51 PM	File Name	GRE-68-12.65_RW_Settle012425.s3z