

SCOPE OF WORK

THIS CONTRACT IS TO UPGRADE THE SIGNING ON THE INTERSTATE, THE INTERSTATE RAMPS, AND THE SIDEROADS. THE WORK CONSISTS OF REPLACING SIGNS ON THEIR NEW/ EXISTING SUPPORTS AND FABRICATED IN ACCORDANCE WITH SECTION 630.04.

IN ACCORDANCE TO THE REQUIREMENTS OF 630.03, THE CONTRACTOR SHALL SUBMIT PRIOR TO FABRICATION, TWO SETS OF SIGN LEGEND WORKING DRAWINGS TO THE OHIO DEPARTMENT OF TRANSPORTATION, OFFICE OF PRODUCTION, 1980 W. BROAD STREET, COLUMBUS, OH 43223.

IN NO CASE SHALL THE CONTRACTOR REMOVE ANY EXISTING SIGN UNTIL THE APPLICABLE REPLACEMENT SIGN CAN IMMEDIATELY THEREAFTER BE ERECTED. OVERHEAD SIGNS SHALL HAVE A CLEARANCE OF 17 FEET. IF PROPOSED SIGN CAUSES CLEARANCE TO BE LESS THAN 17 FEET, APPROVAL OF THE SIGN MUST BE MADE BY THE ENGINEER BEFORE PLACEMENT OF NEW SIGN

ALTHOUGH WE BELIEVE THE PLANS TO BE ESSENTIALLY COMPLETE, WE CANNOT GUARANTEE THEIR ACCURACY DUE TO CONTINUALLY CHANGING CONDITIONS OF THE SIGNING AND SUPPORTS. THE CONTRACTOR SHALL UNDER DIRECTIONS OF THE ENGINEER, MAKE CHANGES AS NECESSARY TO COMPLETE THE JOB.

THE FOLLOWING SIGNS ARE NOT INCLUDED IN THE PLANS:

- I-H14 "ADOPT A HIGHWAY LITTER CONTROL"
- D12-H15 "TARGET ENFORCEMENT AREA" SPECIFIC SERVICE SIGNS (LOGO PROGRAM)

THESE SIGNS SHALL REMAIN IN PLACE.

EXISTING SIGN STRUCTURE VERIFICATION

DETAILS AND DIMENSIONS SHOWN ON THESE PLANS PERTAINING TO THE EXISTING SIGN STRUCTURES (SIGNS, POSTS, BEAMS AND OVERHEAD SIGN SUPPORTS) HAVE BEEN OBTAINED FROM EXISTING SIGNING PLANS AND FROM FIELD OBSERVATIONS AND MEASUREMENTS. CONSEQUENTLY, THEY ARE INDICATIVE OF THE EXISTING SIGN STRUCTURES AND THE PROPOSED WORK, BUT SHALL BE CONSIDERED TENTATIVE AND APPROXIMATE. THE CONTRACTOR IS REFERRED TO CMS SECTIONS 102.05 AND 105.02.

BASE CONTRACT BID PRICES UPON A RECOGNITION OF THE UNCERTAINTIES DESCRIBED ABOVE AND UPON A PREBID EXAMINATION OF THE EXISTING SIGN STRUCTURES (SIGNS, POSTS, BEAMS, AND OVERHEAD SIGN SUPPORTS). HOWEVER, THE DEPARTMENT WILL PAY FOR ALL PROJECT WORK BASED UPON ACTUAL DETAILS AND DIMENSIONS THAT HAVE BEEN VERIFIED IN THE FIELD.

ITEM 630: SIGNING, MISC.: CHECK TORQUE

WORK UNDER THIS ITEM SHALL CONSIST OF CHECKING TORQUE ON ALL EXISTING BREAKAWAY BEAM CONNECTIONS. THE NUT SHALL BE LOOSENEED AND TORQUED IN ACCORDANCE WITH 630.06 (SECTION A.2). PAYMENT FOR THIS ITEM SHALL BE ONE EACH PER LOCATION FOR ITEM 630 - SIGNING, MISC.; CHECK TORQUE.

UTILITIES

BELOW IS A LIST OF UTILITY COMPANIES WHICH MAY HAVE UNDERGROUND INSTALLATIONS ALONG THE VARIOUS ROUTES AFFECTED BY THIS PROJECT. THIS IS NOT TO BE CONSTRUED AS A COMPLETE LIST, BUT RATHER A DIRECTORY OF THE MOST FREQUENTLY ENCOUNTERED COMPANIES.

COLUMBIA GAS OF OHIO
2429 LINDEN AVE.
ZANESVILLE, OH 43701
ATTN: DESI MOLINA
740-450-1205

AMERICAN ELECTRIC POWER
TRANS
825 TECH CENTER DRIVE
GAHANNA, OH 43230
ATTN: MICHELLE ODOM
614-552-1108

AMERICAN ELECTRIC POWER CO.
(DISTRIBUTION)
CENTRAL OHIO REGION
850 TECH CENTER DRIVE
GAHANNA, OH 43230
ATTN: RICK ECKLE
614-883-6829

COLUMBIA GAS TRANSMISSION
310 SOUTH MAPLE STREET
P.O. BOX 330
SUGAR GROVE, OH 43155
ATTN: JOHN RADER
740-746-2279

ITEM 614: MAINTAINING TRAFFIC

TWO LANES OF TRAFFIC IN EACH DIRECTION SHALL BE MAINTAINED ON IR 70 AT ALL TIMES, EXCEPT AS NOTED BELOW:

LANE CLOSURES SHALL ONLY BE IMPLEMENTED AT THE TIMES LISTED ON THE SITE WHICH IS LOCATED AT:

OHIO DEPARTMENT OF TRANSPORTATION'S PERMITTED LANE CLOSURE WEB SITE

https://dotaw100.dot.state.oh.us/plcm/plcm_web.jsp

THE PERMITTED CLOSURE TIMES LISTED ON THE WEBSITE, 14 CALENDAR DAYS PRIOR TO THE BID LETTING DATE, SHALL BE IN EFFECT FOR THIS PROJECT.

NO WORK WITHIN ACTIVE TRAVEL LANES OR WHICH WILL SLOW TRAFFIC IS PERMITTED AT ANY OTHER TIMES.

WHEN NECESSARY, LANE CLOSURES SHALL BE ACCOMPLISHED IN ACCORDANCE WITH THE STANDARD DRAWINGS. LENGTH AND DURATION OF LANE CLOSURES AND RESTRICTIONS SHALL BE AT THE APPROVAL OF THE ENGINEER.

ALL WORK AND TRAFFIC CONTROL DEVICES SHALL BE IN ACCORDANCE WITH CMS 614 AND OTHER APPLICABLE PORTIONS OF THE SPECIFICATIONS, AS WELL AS THE OHIO MANUAL OF UNIFORM TRAFFIC CONTROL DEVICES. PAYMENT FOR ALL LABOR, EQUIPMENT AND MATERIALS SHALL BE INCLUDED IN THE LUMP SUM CONTRACT PRICE FOR ITEM 614, MAINTAINING TRAFFIC.

GUERNSEY-MUSKINGUM
ELECTRIC COOPERATIVE, INC
17 S. LIBERTY ST.
NEW CONCORD, OH 43762
ATTN: JOHN MARSHALL
740-826-7661

SBC (AMERITECH)
3935 NORTH POINT RD
ZANESVILLE, OH 43710
ATTN: SANDI RANDOLPH
740-454-3455

VERIZON
9444 CAMPBELL ST.
P.O. BOX 190
CAMBRIDGE, OH 43725
ATTN: JEFF ARNOLD
740-432-7137

EDWARD F. SCHMELZER
DISTRICT 5 UTILITY
COORDINATOR
ESCHMELZ@DOT.STATE.OH.US
740-323-5126

ITEM 631: REMOVAL OF SIGN SERVICE AND DISPOSAL, AS PER PLAN WORK UNDER THIS ITEM SHALL CONSIST OF REMOVING ALL CABLE AND OTHER EQUIPMENT FOR THE USE OF LIGHTING FROM THE LUMINAIRE TO THE TOP OF THE DISCONNECT SWITCH. DISPOSAL OF ITEMS SHALL BE ACCORDING TO 105.17. MEASUREMENT FOR THIS ITEM SHALL BE ONE EACH PER ILLUMINATED SIGN.

PAYMENT WILL BE MADE AT THE CONTRACT UNIT PRICE BID PER EACH OF ITEM 631 REMOVAL OF SIGN SERVICE AND DISPOSAL, AS PER PLAN.

ITEM 630: SIGNING, MISC.: GROUND MOUNTED SUPPORT

THIS ITEM SHALL INCLUDE ALL LABOR AND EQUIPMENT NECESSARY TO INSTALL A MULTI-DIRECTIONAL, BREAKAWAY TRAFFIC SIGN SUPPORT SYSTEM. THIS SYSTEM SHALL MEET OR EXCEED ALL REQUIREMENTS OF NCHRP REPORT #350.

THE SIGN SUPPORT SYSTEM SHALL INCLUDE THE FOLLOWING COMPONENTS: 1) A GROUND STUB, 3" SCHEDULE 40, HOT DIP GALVANIZED PIPE, 36" LONG WITH A TRIANGULAR PLATE WELDED TO IT; 2) A GALVANIZED STEEL BOLT RETAINER PLATE; 3) A ZINC PLATED STEEL SPLIT LOCKING COLLAR OR SIMILAR DEVICE TO KEEP THE SLIP BASE CASTING ON THE TRAFFIC POST; 4) A SLIP BASE CASTING WHICH SLIDES ONTO THE POST (ACTING AS THE POST SUPPORT); 5) A TRAFFIC POST, 2 7/8" OUTSIDE DIAMETER. THE TRAFFIC POSTS SHALL BE ABLE TO SUPPORT AT A MINIMUM: 50 SQUARE FOOT OF SIGN AREA PER POST IN A 90 MPH WIND.

PAYMENT FOR THIS ITEM SHALL INCLUDE ALL LABOR, EQUIPMENT, MATERIALS AND INCIDENTALS NECESSARY TO INSTALL A MULTI-DIRECTIONAL BREAKAWAY TRAFFIC SIGN SUPPORT AT THE CONTRACT UNIT PRICE FOR ITEM 630 SIGNING, MISC.: GROUND MOUNTED SUPPORT.

- ITEM 630: GROUND MOUNTED SUPPORT, W12X30 BEAM, AS PER PLAN
- ITEM 630: SIGN SUPPORT ASSEMBLY, POLE MOUNTED, AS PER PLAN
- ITEM 630: SIGN, OVERHEAD EXTRUSHEET, AS PER PLAN
- ITEM 630: SIGNING, MISC.: GROUND MOUNTED SUPPORT FOR STORAGE
- ITEM 630: SIGN ATTACHMENT ASSEMBLY, AS PER PLAN
- ITEM 630: GROUND MOUNTED SUPPORT, W10X22 BEAM, AS PER PLAN
- ITEM 630: BREAKAWAY CONNECTION, AS PER PLAN
- ITEM 630: SIGN, FLAT SHEET, AS PER PLAN
- ITEM 630: SIGN, GROUND MOUNTED EXTRUSHEET, AS PER PLAN
- ITEM 630: GROUND MOUNTED SUPPORT, NO. 4 POST, AS PER PLAN

ALL MATERIALS REQUIRED TO INSTALL THESE ITEMS SHALL BE DELIVERED TO ODOT DISTRICT 5 (9600 JACKSONTOWN RD. JACKSONTOWN, OHIO, 43030 (CONTACT: TROY RODENISER, (740) 323-4400 x5285) FOR STORAGE. THESE MATERIALS SHALL BE INSPECTED AND APPROVED BY ODOT PRIOR TO DELIVERY TO THE STORAGE FACILITY. THE CONTRACTOR SHALL MAKE ARRANGEMENTS FOR DELIVERY THROUGH PROJECT ENGINEER WITH A 7 DAYS ADVANCE NOTICE TO TROY RODENISER.

THESE ITEMS WILL BE INSTALLED WITH A DIFFERENT PROJECT (OR BY OTHERS). IT SHALL BE NOTED THAT FOR SIGNING, MISC.: GROUND MOUNTED SUPPORT FOR STORAGE, THE OTHER REQUIREMENTS SPECIFIED ELSEWHERE FOR ITEM 630: SIGNING MISC.: GROUND MOUNTED SUPPORT SHALL APPLY EXCEPT THE INSTALLATION.

ALL OTHER RELATED ITEMS OF WORK BETWEEN IR-70 MILE MARKER 152.6 TO 156.7 WILL BE INCLUDED WITH THAT PROJECT (e .g. REMOVAL OF RELATED EXISTING SIGNS, SUPPORT FOUNDATION CONCRETE, ETC.) UNLESS DIRECTED OTHERWISE BY THE PROJECT ENGINEER.

08/25/2004 03:52:42 PM M:\proj\0221\05 22 Sign Inventory\project plans\sheets\1d002170.dgn

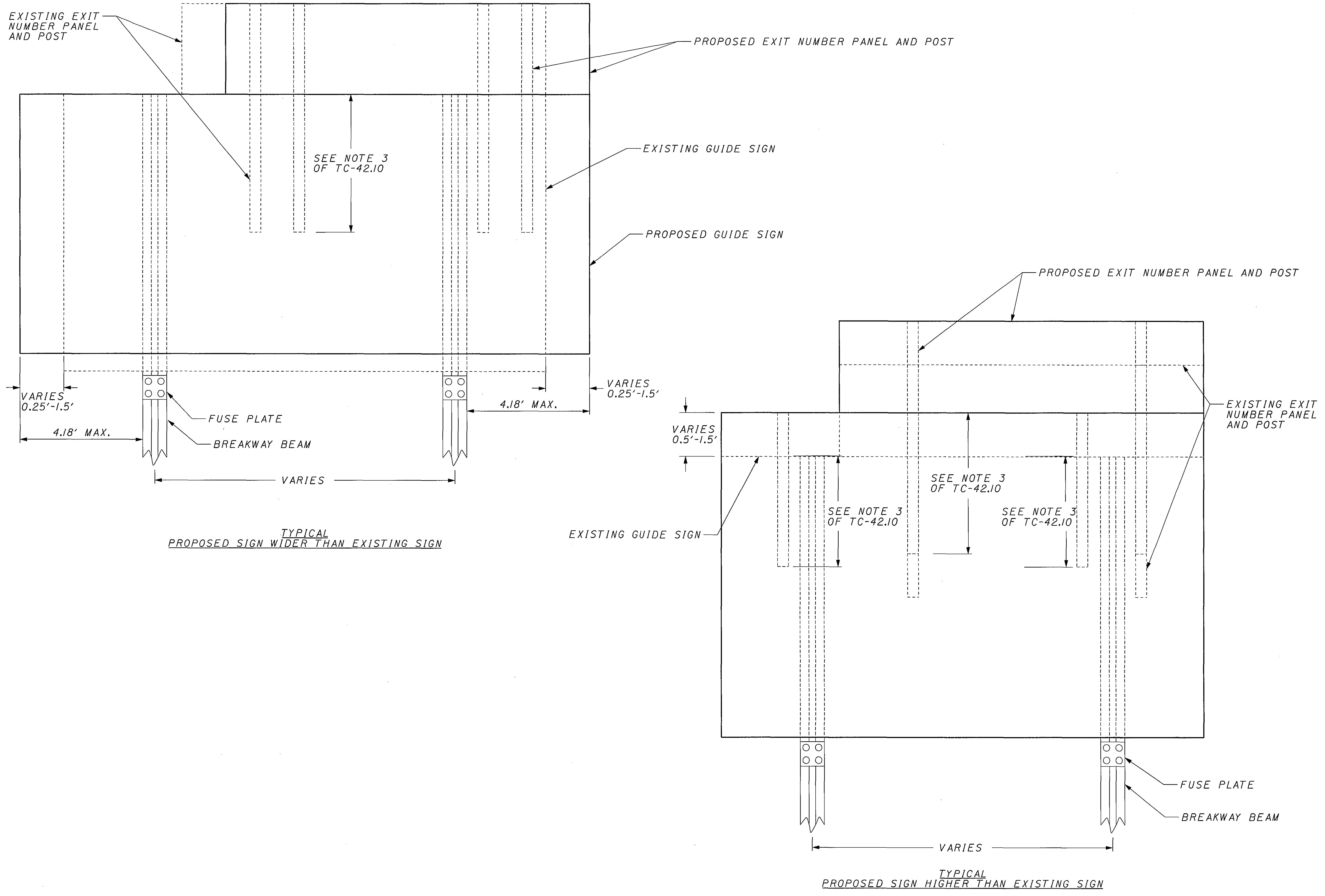

TYPICAL PROPOSED SIGN WIDER THAN EXISTING SIGN

TYPICAL PROPOSED SIGN HIGHER THAN EXISTING SIGN

NOT TO SCALE

CALCULATED
DCB
CHECKED
WEB

TYPICAL GUIDE SIGN REPLACEMENT

D05-SIGN-FY2005

08/25/2004
03:56:43 PM
M:\pro\0221\505\22 Sign Inventory\project plans\sheet\td001170.dgn

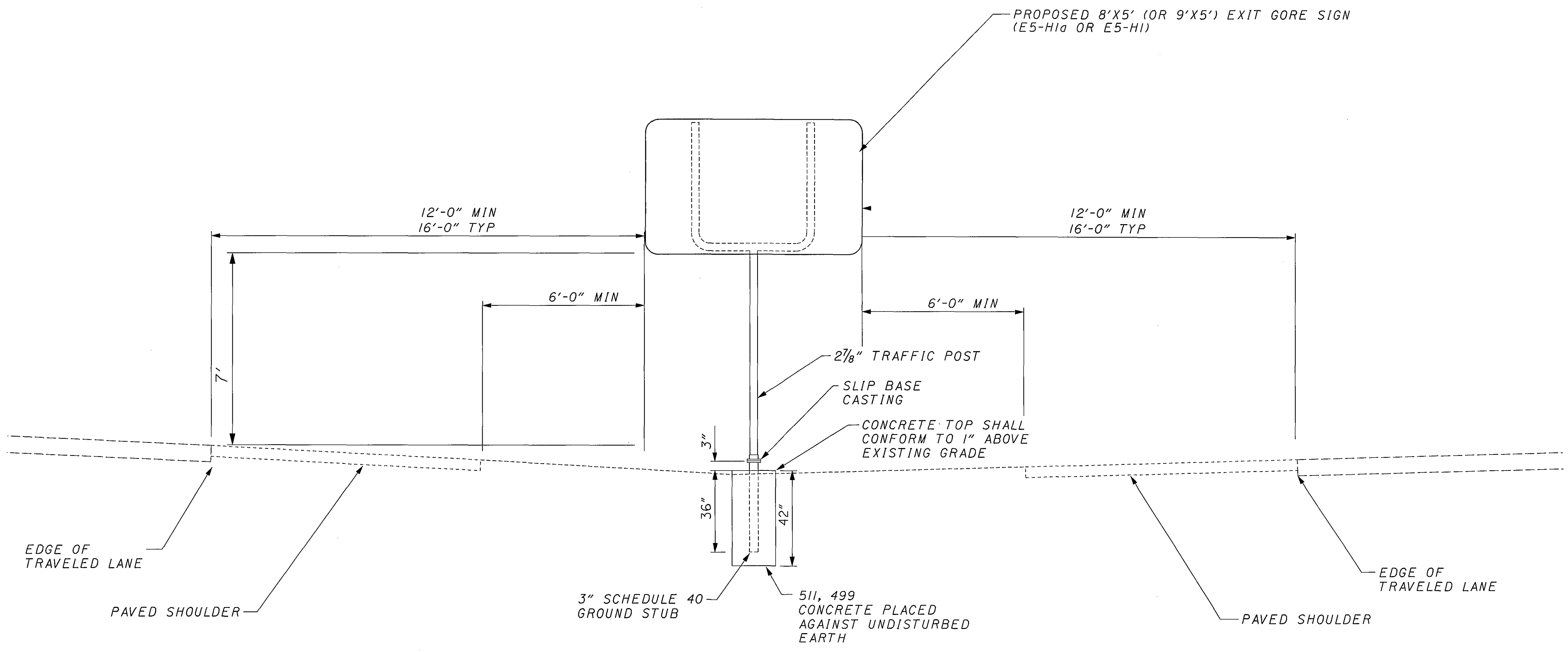

TYPICAL
"SIGNING, MISC.: GROUND MOUNTED SUPPORT"
MULTI-DIRECTIONAL BREAKAWAY TRAFFIC SIGN SUPPORT SYSTEM

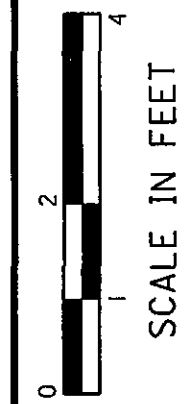

CALCULATED
DCB
CHECKED
EHT

TYPICAL EXIT GORE SIGN

D05 - SIGN - FY2005

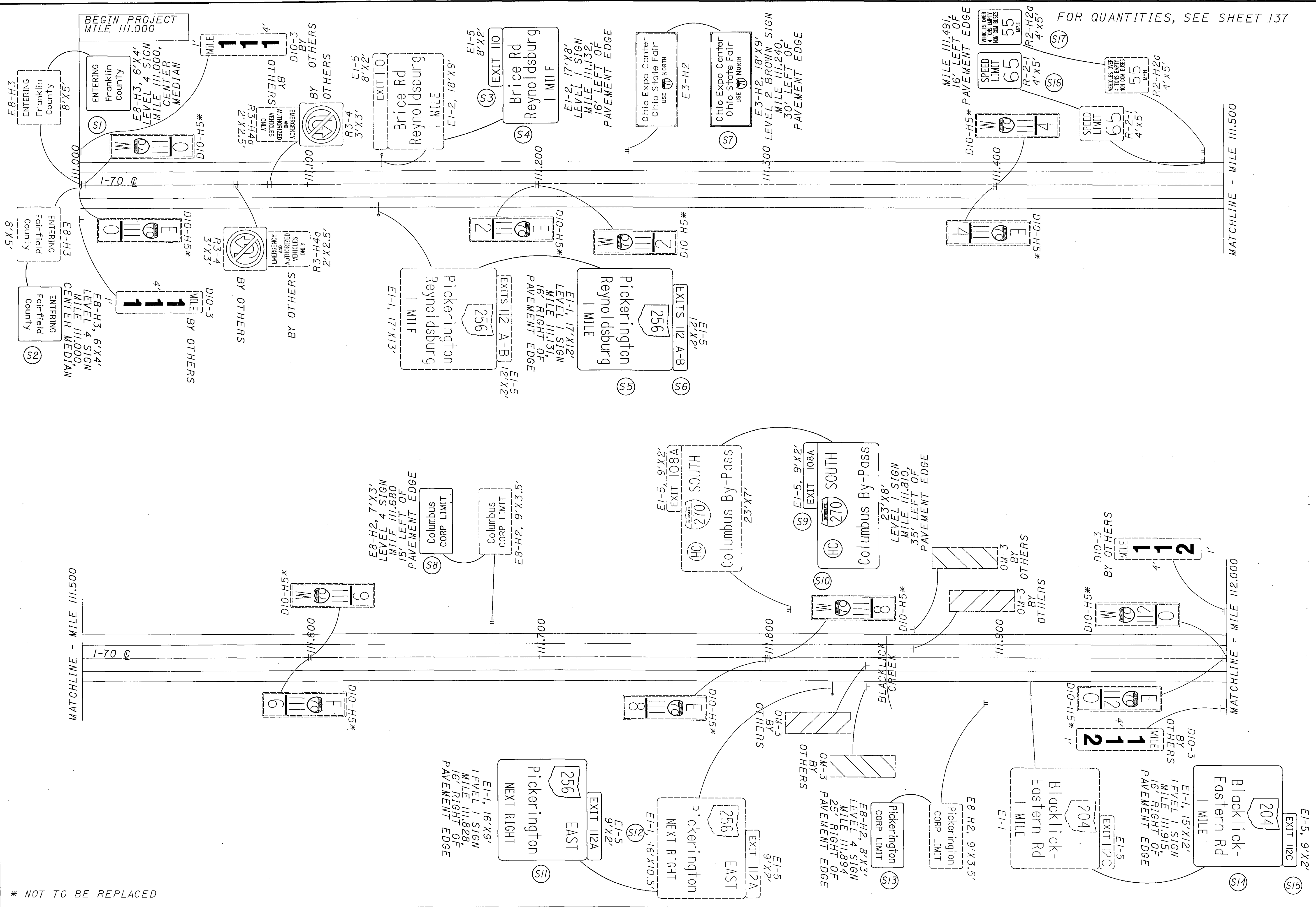

**FAIRFIELD COUNTY
MILE 111.000 TO MILE 112.000**

D05-SIGN-FY2005

6
166

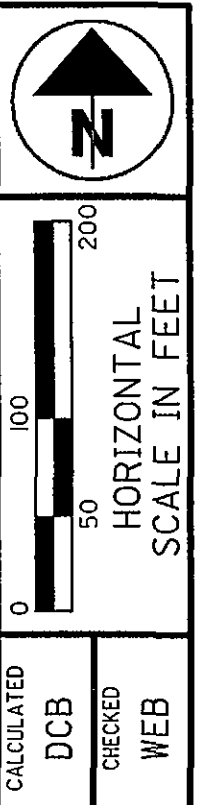

08/13/2004
03:54:08 PM
nt:\p\0221605\22 sign inventory\project plans\plansheets\tp02170.dgn

* NOT TO BE REPLACED

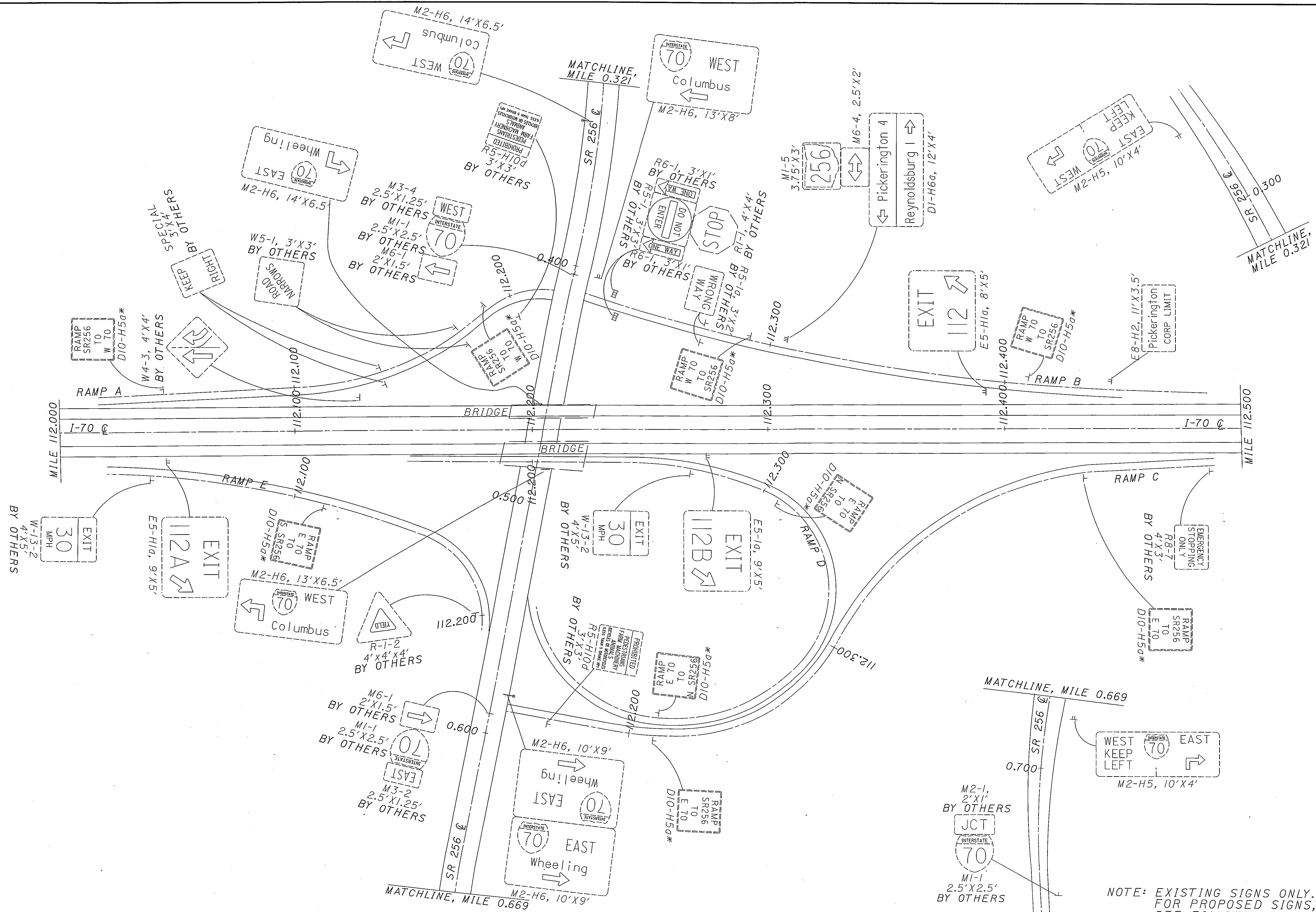

NOTE: EXISTING SIGNS ONLY.
FOR PROPOSED SIGNS,
SEE FOLLOWING SHEET.

0 100 200
HORIZONTAL SCALE IN FEET

CALCULATED
DCB
CHECKED
WEBB

FAIRFIELD COUNTY
SR 256 INTERCHANGE

D05-SIGN-FY2005

FOR QUANTITIES, SEE SHEET 137



0 50 100 200
HORIZONTAL
SCALE IN FEET

CALCULATED
DCB
CHECKED
WEB

**FAIRFIELD COUNTY
SR 256 INTERCHANGE**

D05-SIGN-FY2005

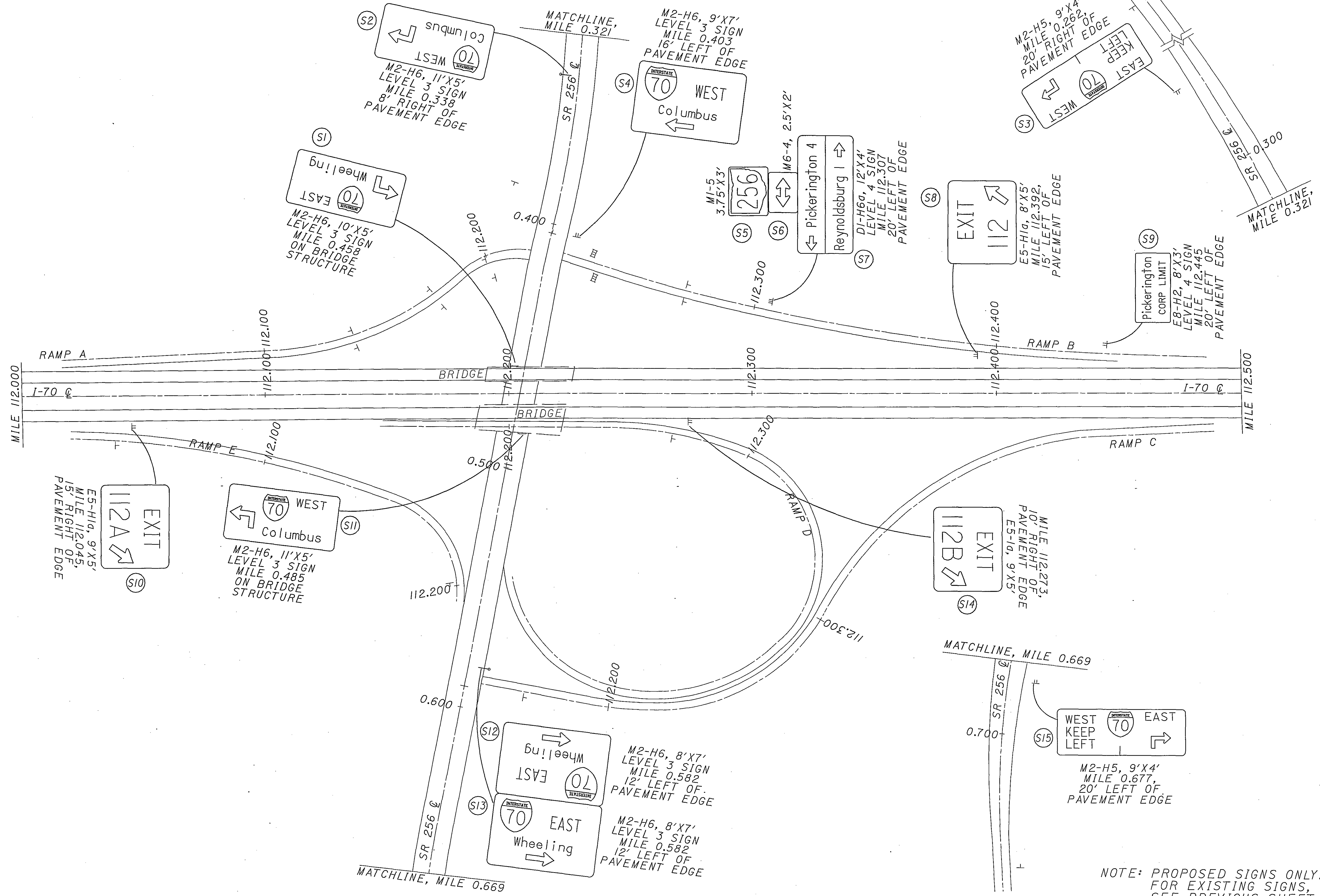

NOTE: PROPOSED SIGNS ONLY.
FOR EXISTING SIGNS,
SEE PREVIOUS SHEET.

08/13/2004
03:54:06
m:\prj\022\1505\22 sign inventory\project plans\plansheets\tp003170.dgn

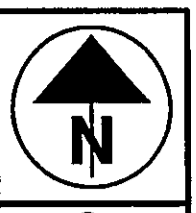

200
100
0
HORIZONTAL SCALE IN FEET

CALCULATED
DCB
CHECKED
WEB

00011 FAIRFIELD COUNTY MILE 112.000 TO MILE 113.000

00200 Y F - SIGN - 505

9 99

FOR QUANTITIES, SEE SHEET 138

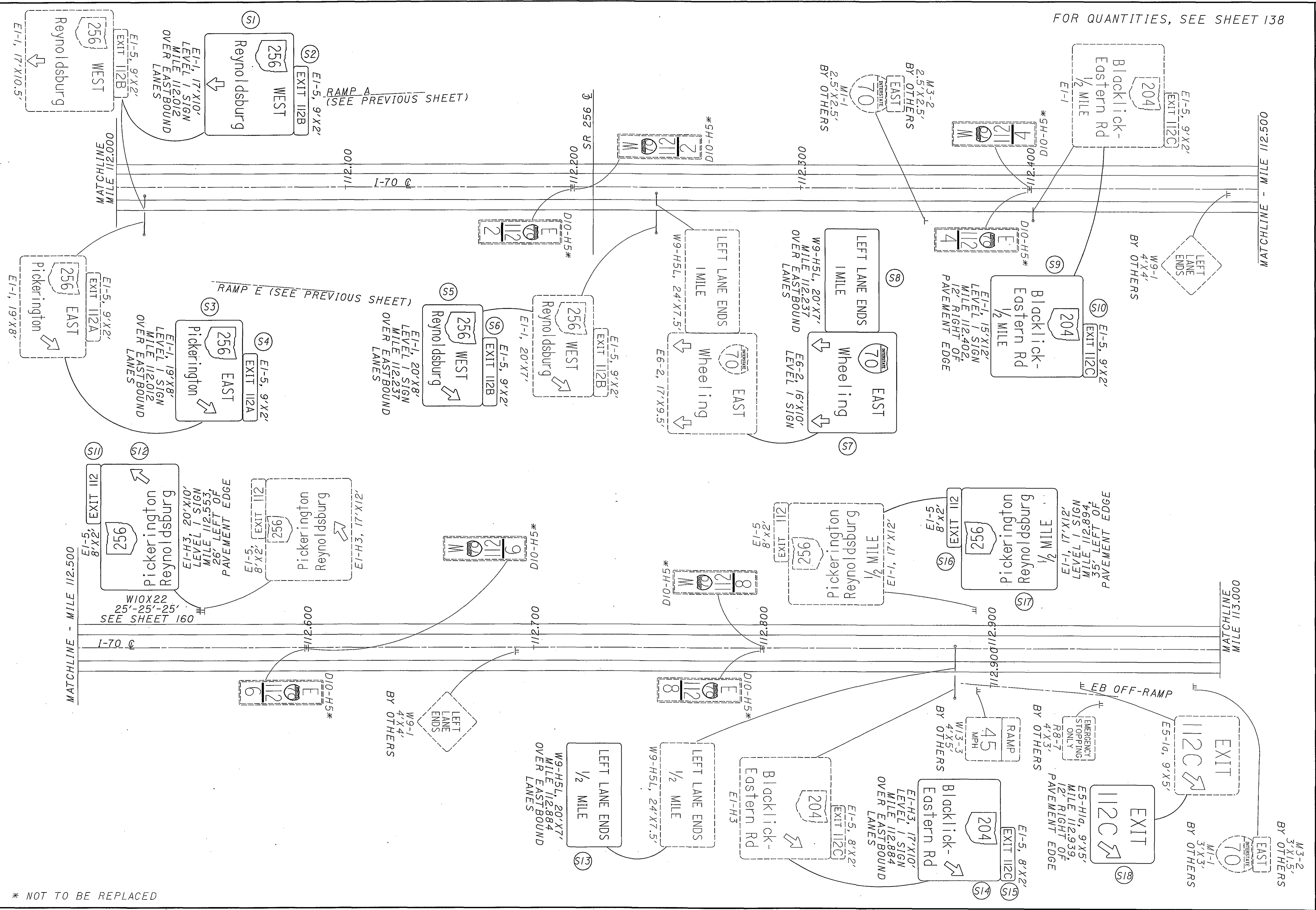

* NOT TO BE REPLACED

08/13/2004 03:54:06 PM m:\brol\0221605\22 sign inventory\project plans\plansheets\tp004170.dgn

* NOT TO BE REPLACED

MATCHLINE - MILE 114.000

MATCHLINE - MILE 114.500

I-70

I-70

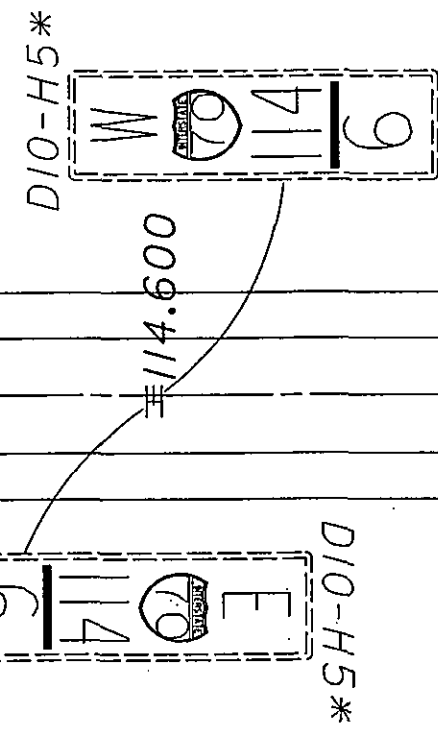
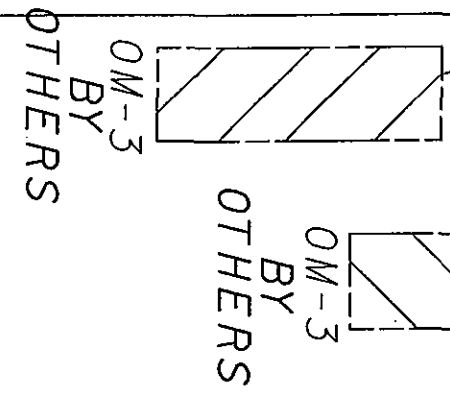

114.600

114.700

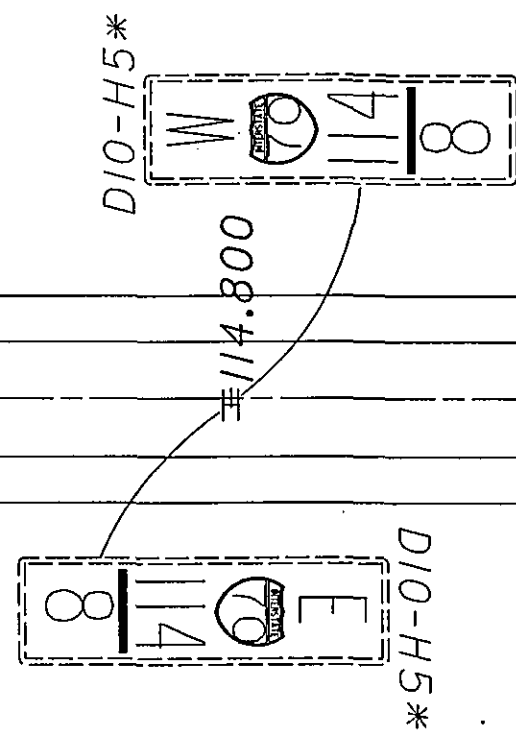

114.800

114.900

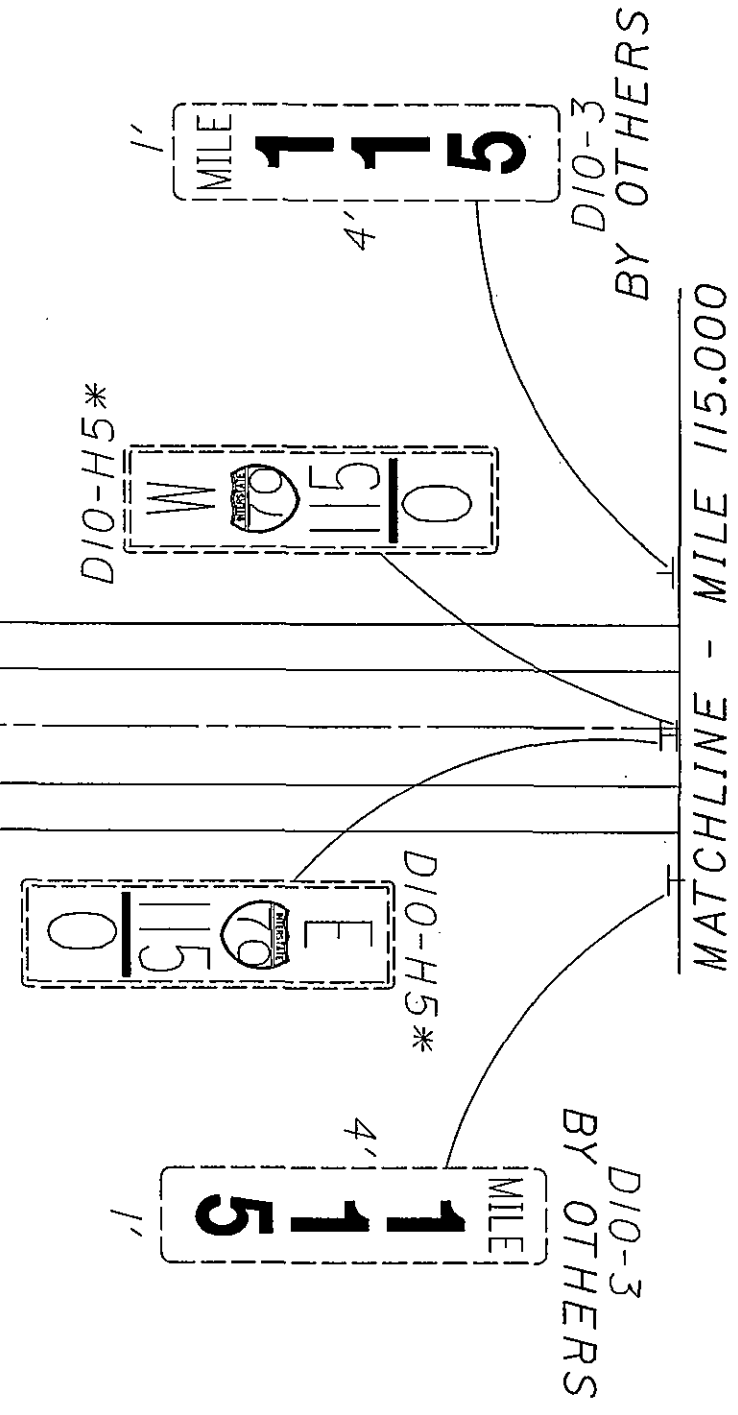

MATCHLINE - MILE 115.000

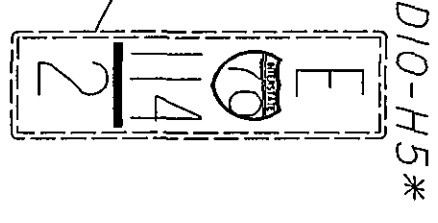
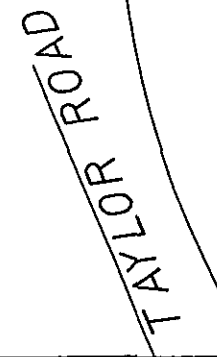

D10-H5*

114.200

D10-H5*

R14-MOD

(S)

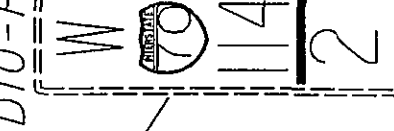

THRU HAZARDOUS
 CARGO CARRIERS
 MUST USE (270) (HC)
 COLUMBUS BY-PASS

114.300

D10-H5*

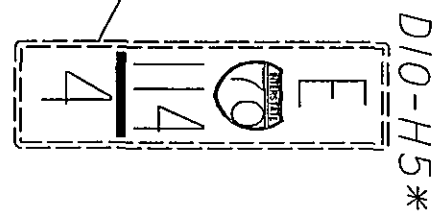

D10-H5*

114.400

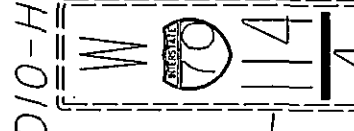

D10-H5*

114.300

D10-H5*

R14-MOD, 19X10'

LEVEL 1, SIGN

MILE 114.153,

25' LEFT OF

PAVEMENT EDGE

FOR QUANTITIES, SEE SHEET 138

* NOT TO BE REPLACED

MATCHLINE - MILE 115.000

MATCHLINE - MILE 115.500

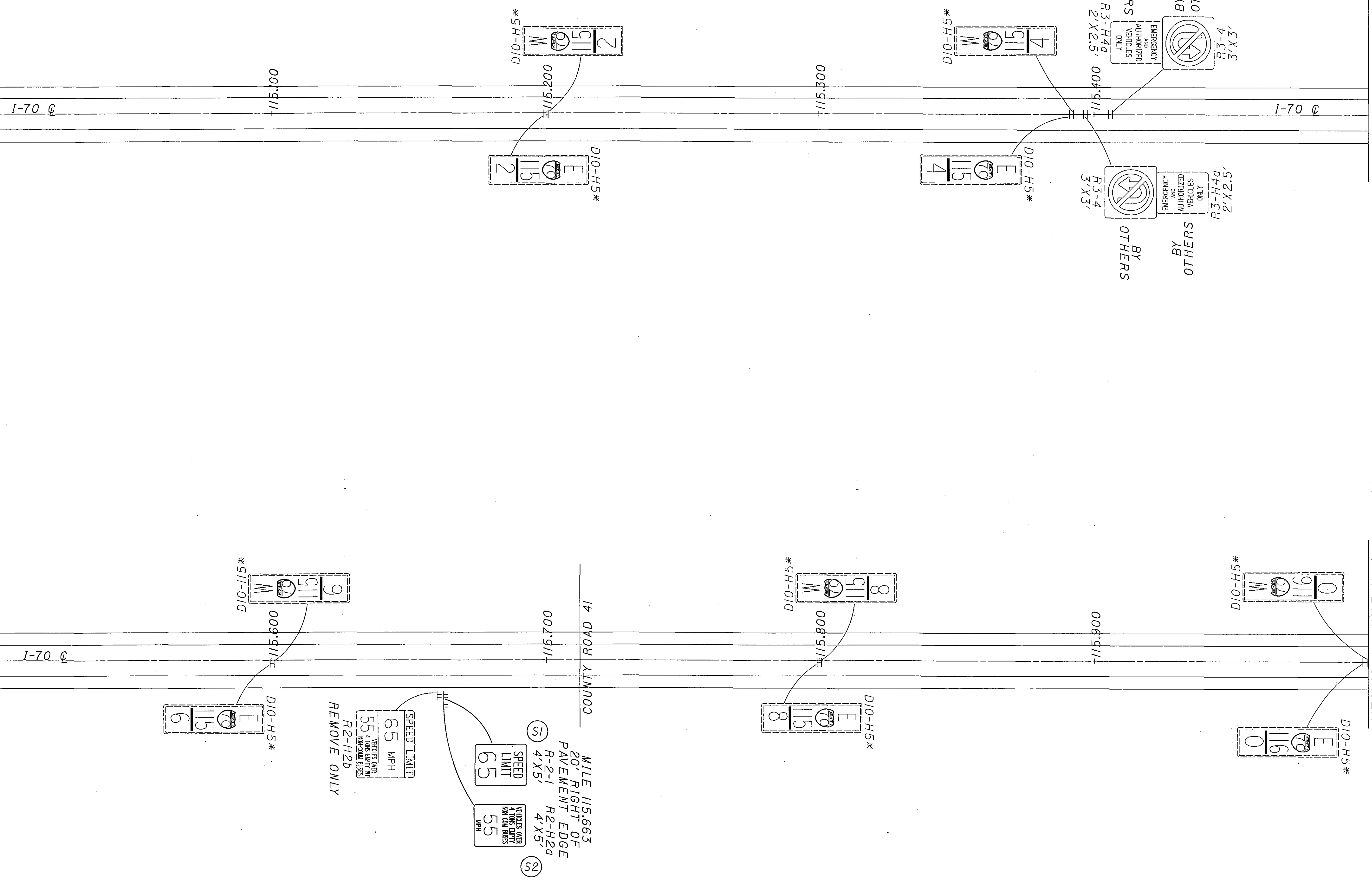

FOR QUANTITIES, SEE SHEET 138

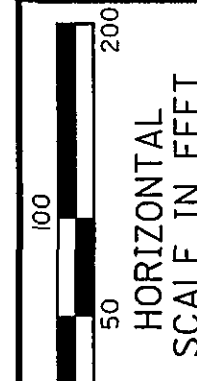
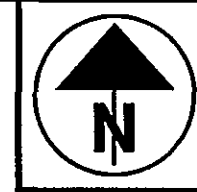

CALCULATED
 DCB
 CHECKED
 WEB

LICKING COUNTY
 MILE 115.000 TO MILE 116.000

D05-SIGN-FY2005

* NOT TO BE REPLACED

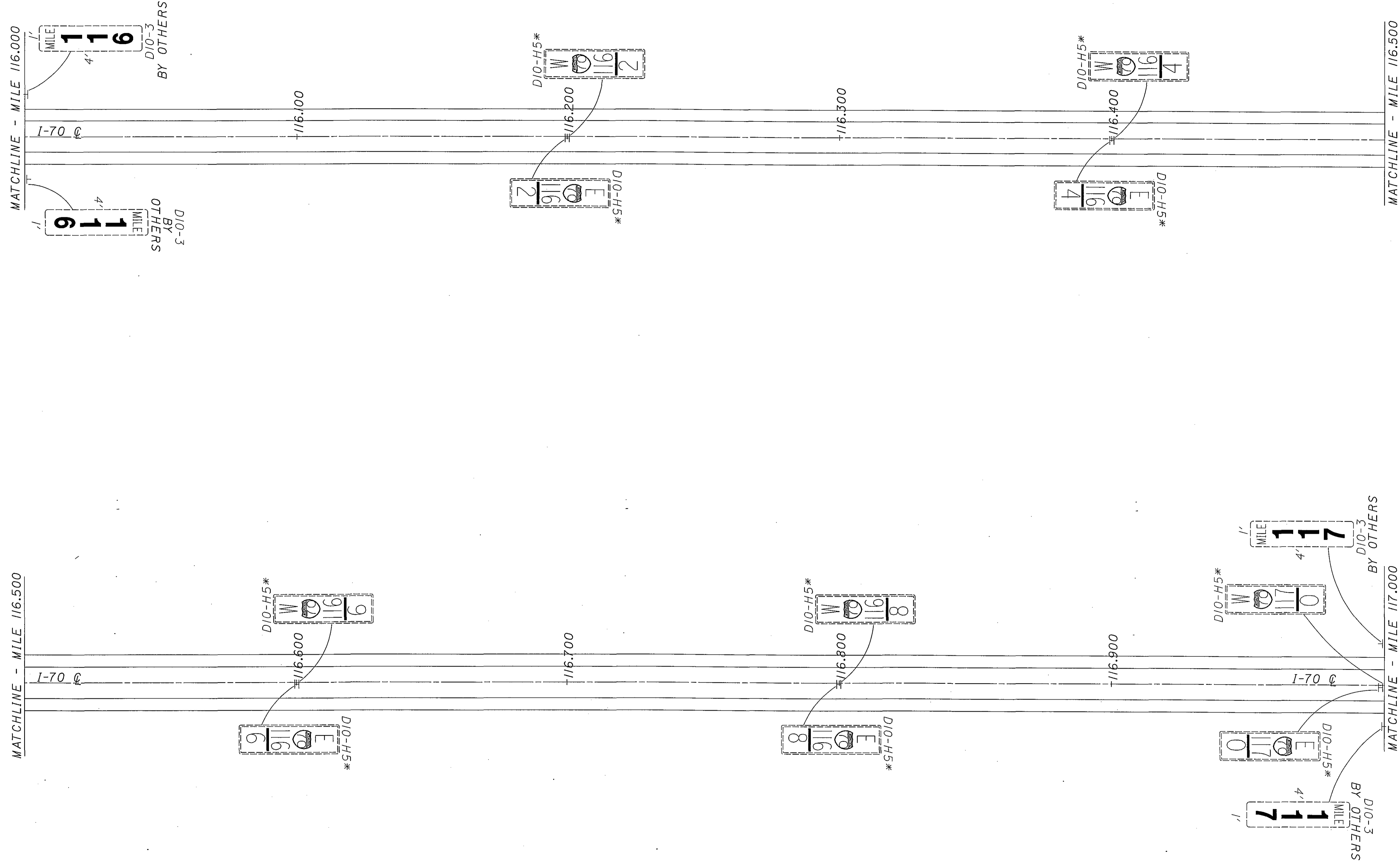

MATCHLINE - MILE 117.000

MATCHLINE - MILE 117.500

MATCHLINE - MILE 117.500

MATCHLINE - MILE 118.000

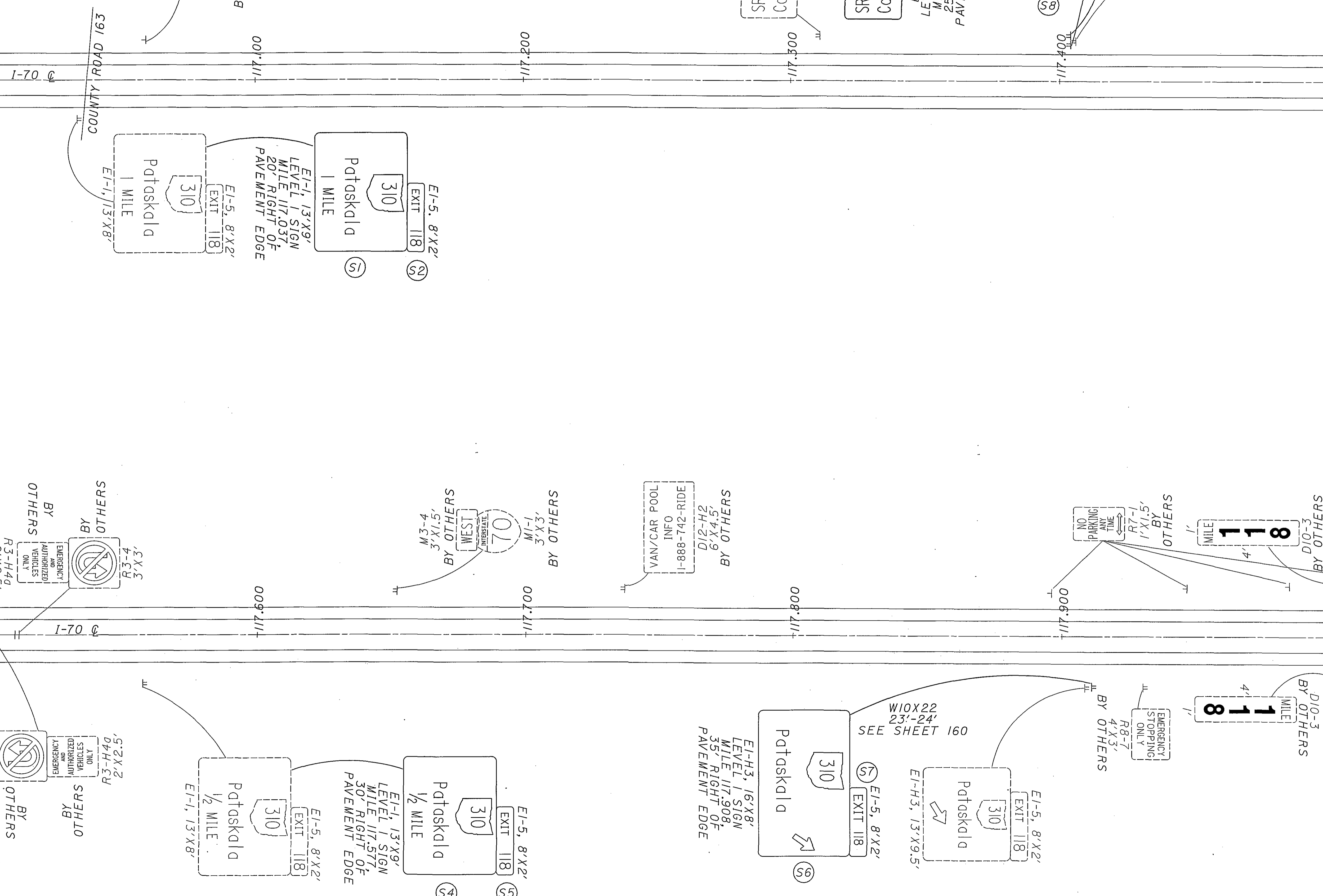

FOR QUANTITIES, SEE SHEET 138

CALCULATED DCB CHECKED WEB

0 50 100 200
 HORIZONTAL SCALE IN FEET

0 100 200
 SCALE IN FEET

LICKING COUNTY
 MILE 117.000 TO MILE 118.000

D05 - SIGN - FY 2005

08/13/2004
03:54:40 PM
m:\p\01\022\1505\22 sign inventory\project plans\plansheets\fp01070.dgn

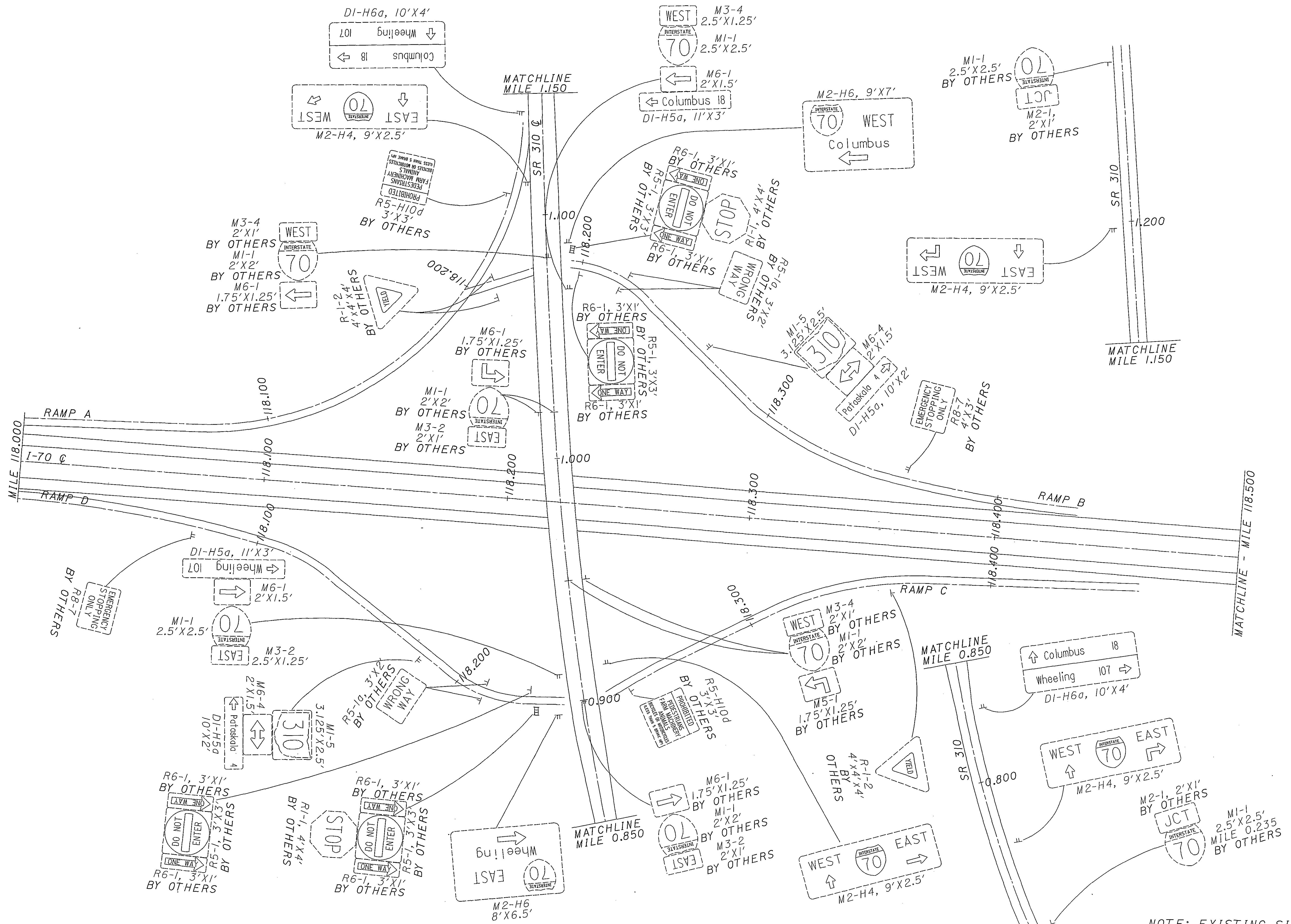

NOTE: EXISTING SIGNS ONLY.
FOR PROPOSED SIGNS,
SEE FOLLOWING SHEET.

CALCULATED
DCB
CHECKED
WEB

0 100 200
HORIZONTAL
SCALE IN FEET

LICKING COUNTY
SR 310 INTERCHANGE

D05 - SIGN - FY 2005

08/13/2004
 09:47:06 PM
 m:\p\01\022\1505\22 sign inventory\project plans\plansheets\tp01170.dgn

FOR QUANTITIES, SEE SHEET 139

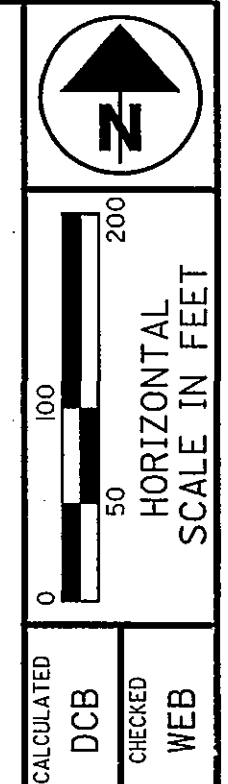

CALCULATED
 DCB
 CHECKED
 WEB

LICKING COUNTY
 SR 310 INTERCHANGE

D05-SIGN-FY2005
 16
 166

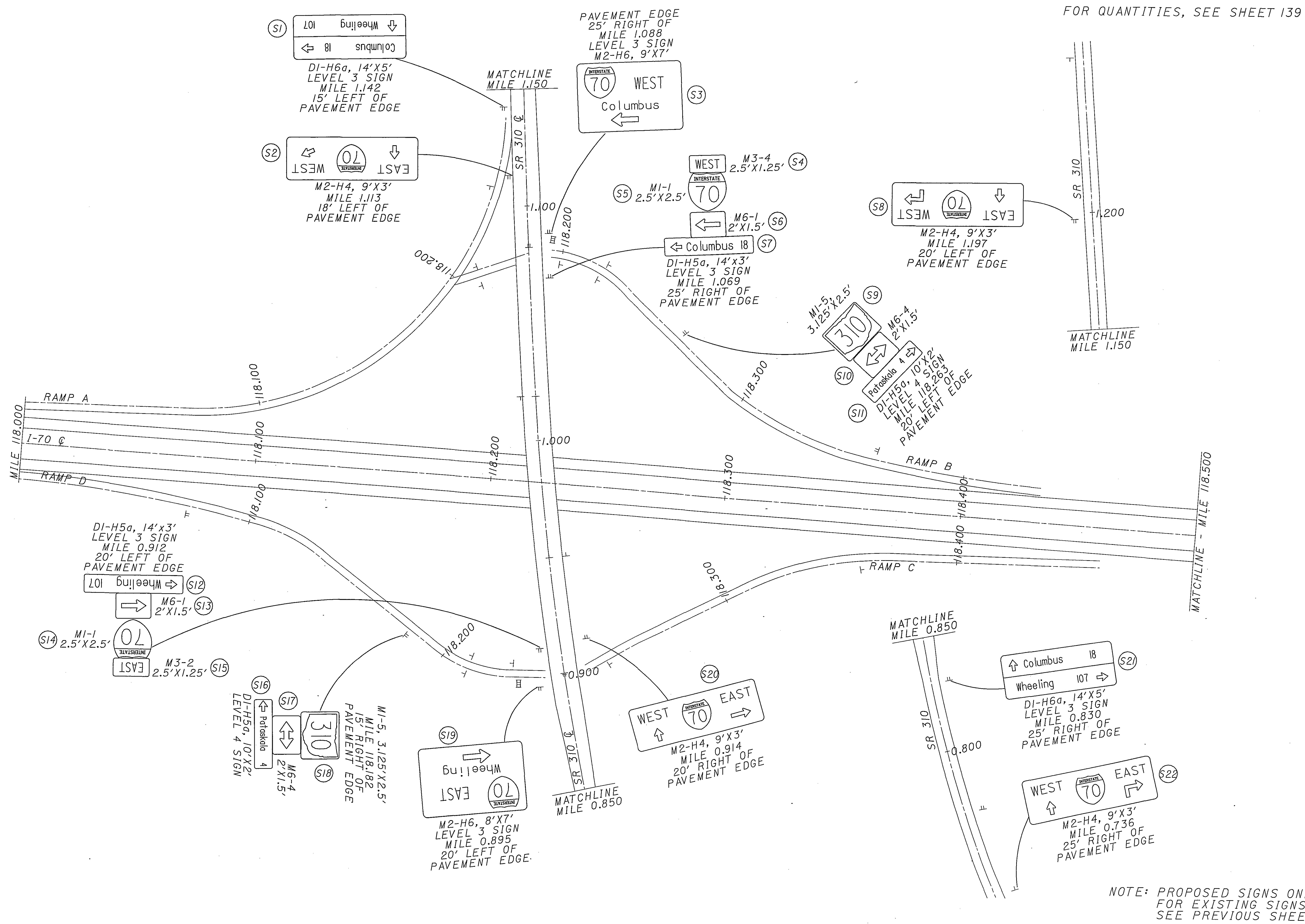

NOTE: PROPOSED SIGNS ONLY.
 FOR EXISTING SIGNS,
 SEE PREVIOUS SHEET.

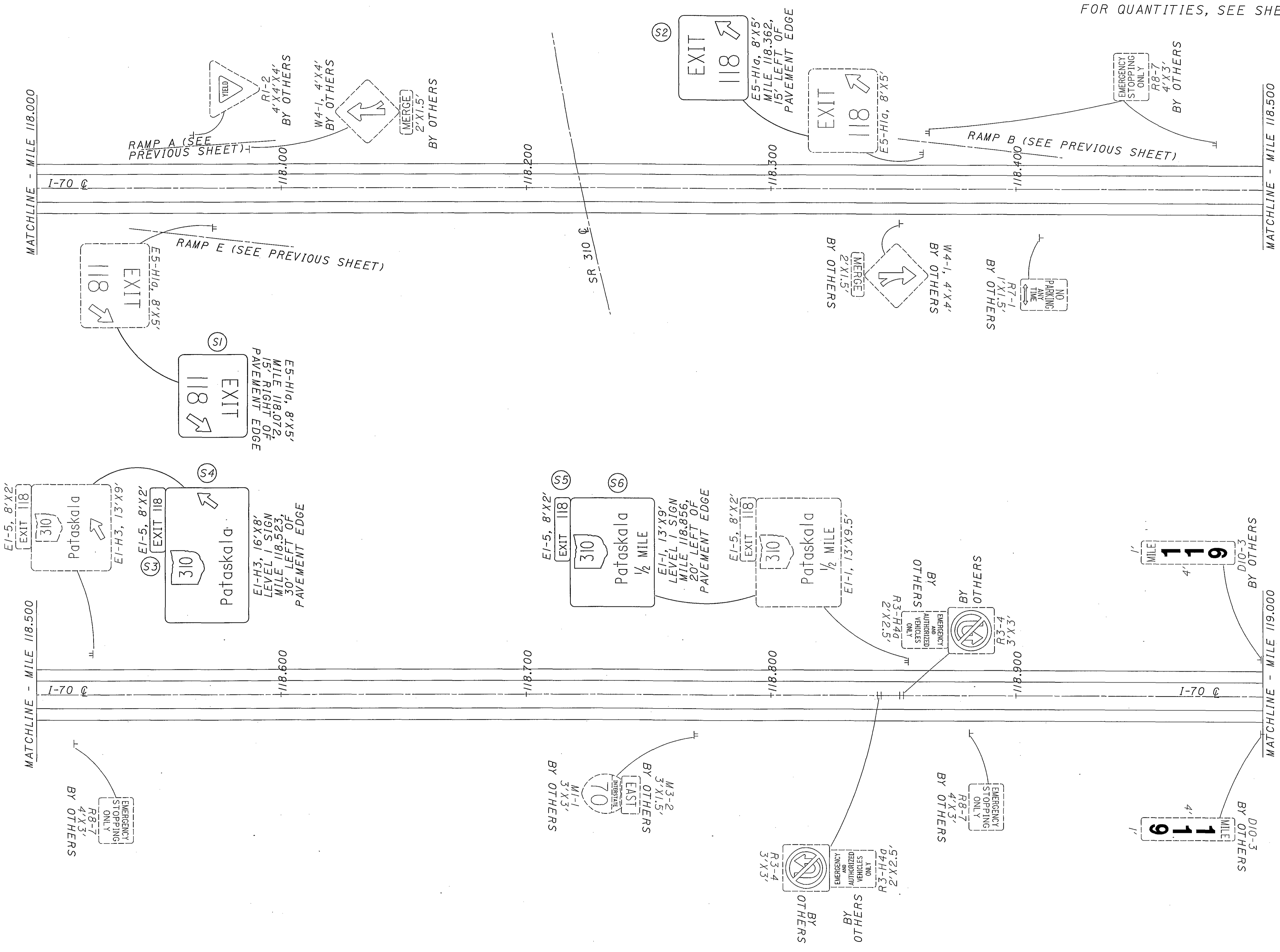

LICKING COUNTY
MILE 118.000 TO MILE 119.000

D05-SIGN-FY2005

CALCULATED DOB CHECKED WEB
 0 100 200
 HORIZONTAL SCALE IN FEET

MATCHLINE - MILE 119.500

MATCHLINE - MILE 119.000

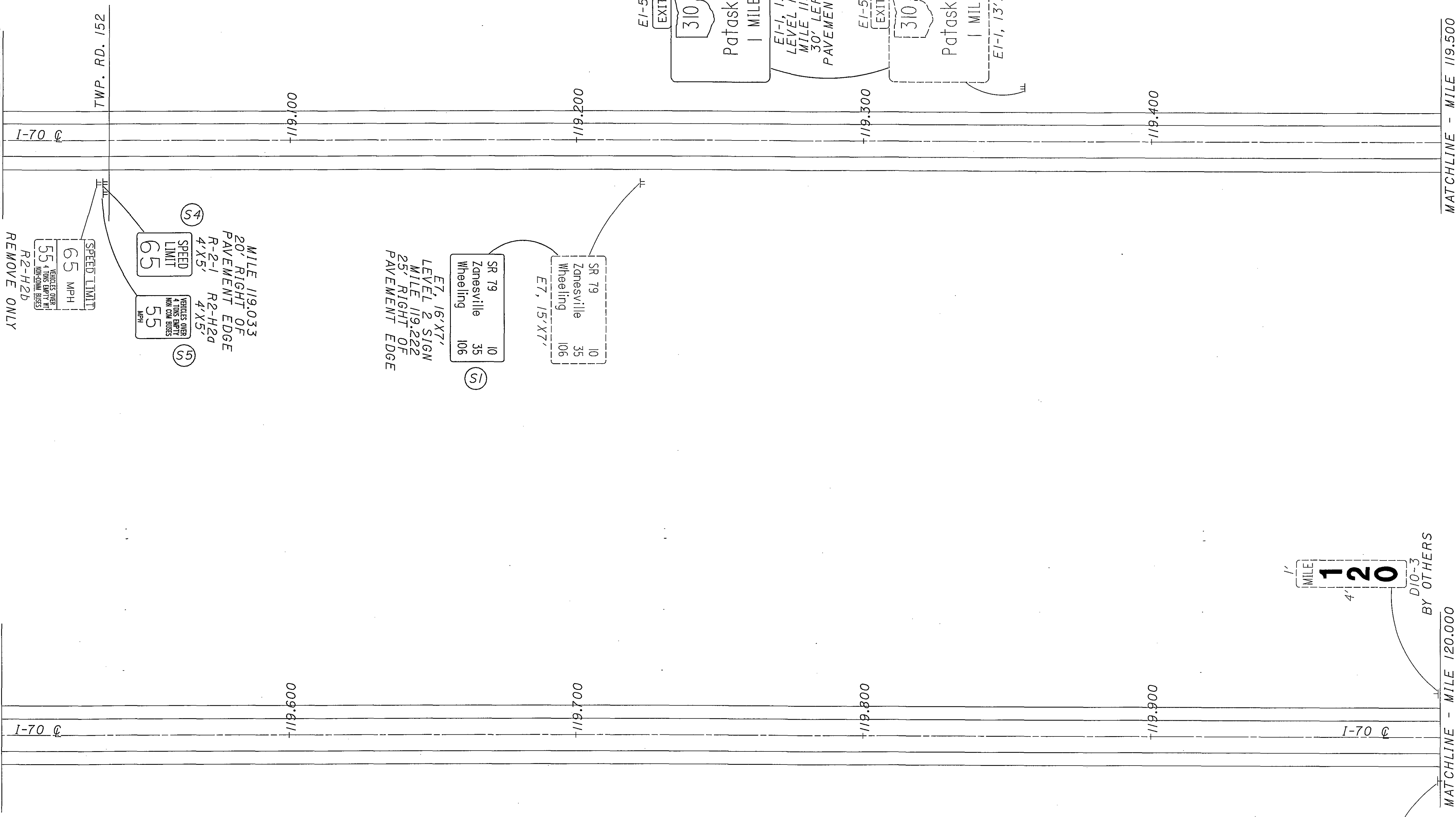

FOR QUANTITIES, SEE SHEET 139

MATCHLINE - MILE 120.000

I-70 ϕ

TWP. RD. 42

+120,100

+120,200

+120,300

+120,400

MATCHLINE - MILE 120.500

MATCHLINE - MILE 120.500

I-70 ϕ

+120,600

+120,700

+120,800

+120,900

MATCHLINE - MILE 121.000

MILE 121
D10-3
BY OTHERS

MILE 121
D10-3
BY OTHERS

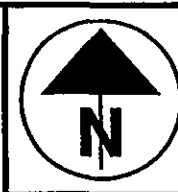

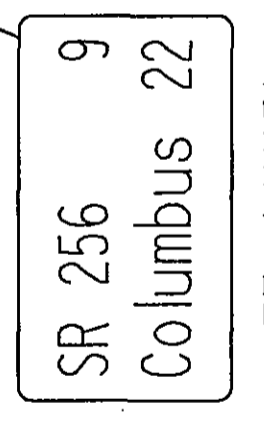
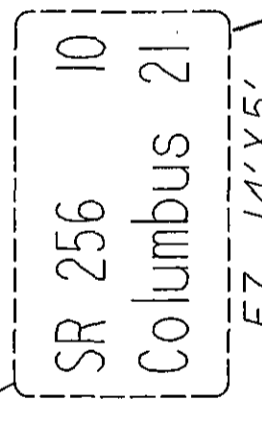
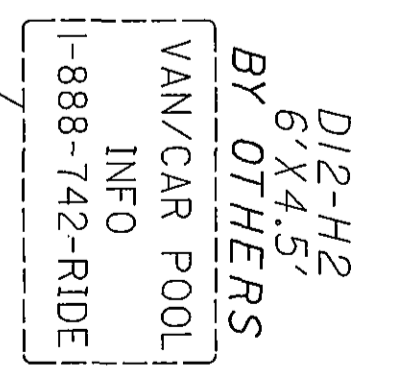
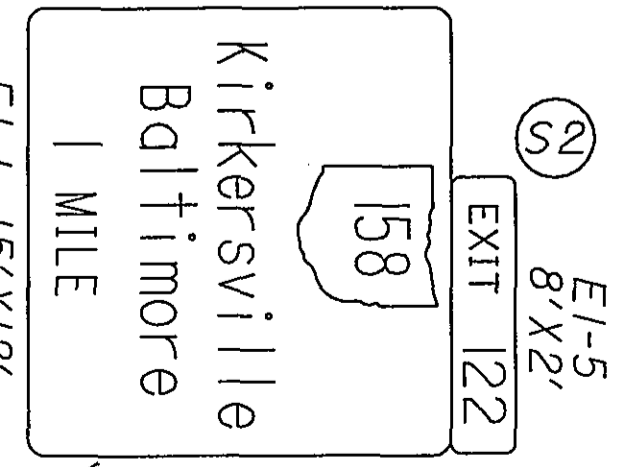
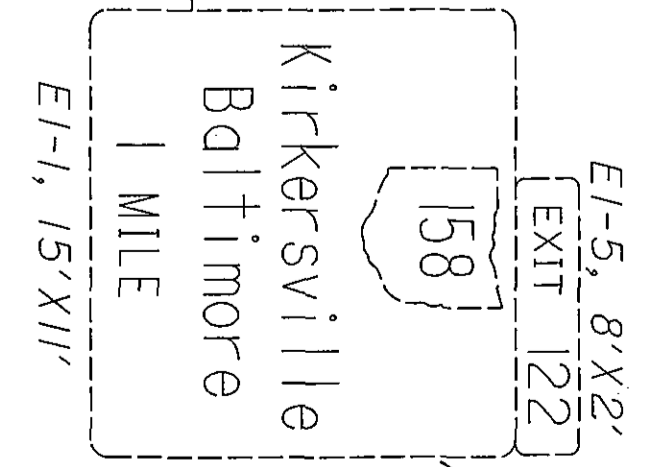
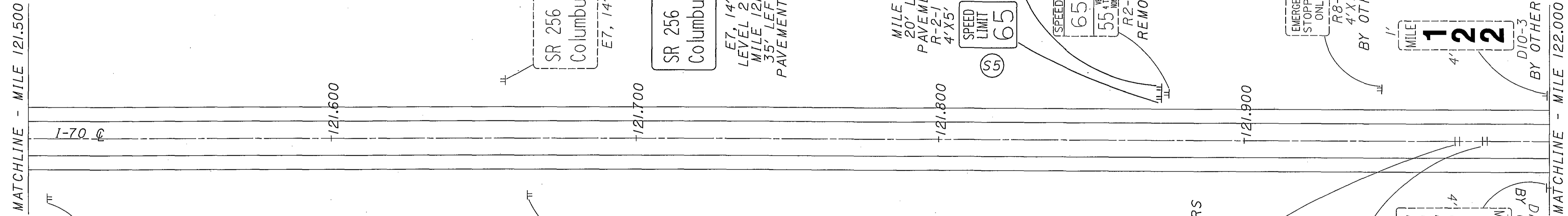
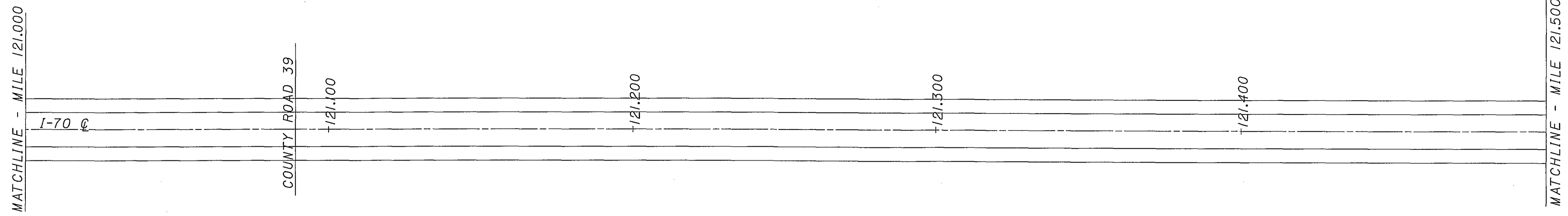

E7, 14'x5',
 LEVEL 2 SIGN
 MILE 121.657,
 35' LEFT OF
 PAVEMENT EDGE

MILE 121.872,
 20' LEFT OF
 PAVEMENT EDGE
 R-2-1 R2-H2a
 4'x5'

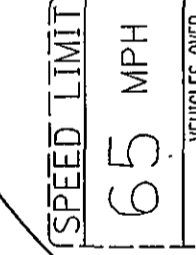

R2-H2b
 REMOVE ONLY

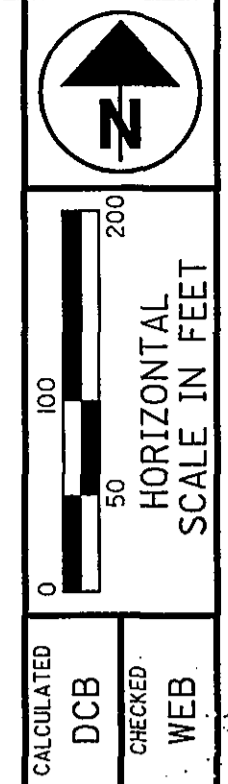
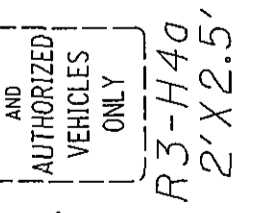
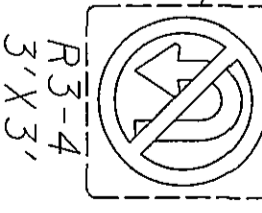
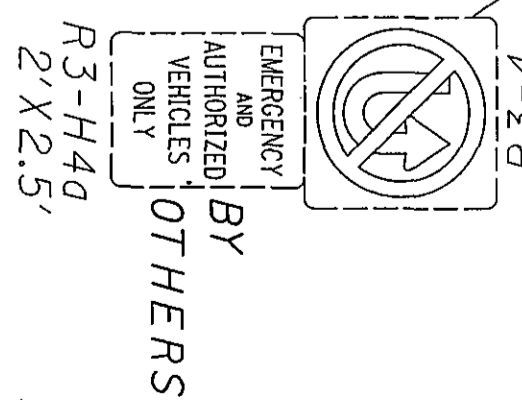

LICKING COUNTY
 MILE 121.000 TO MILE 122.000

D05-SIGN-FY2005

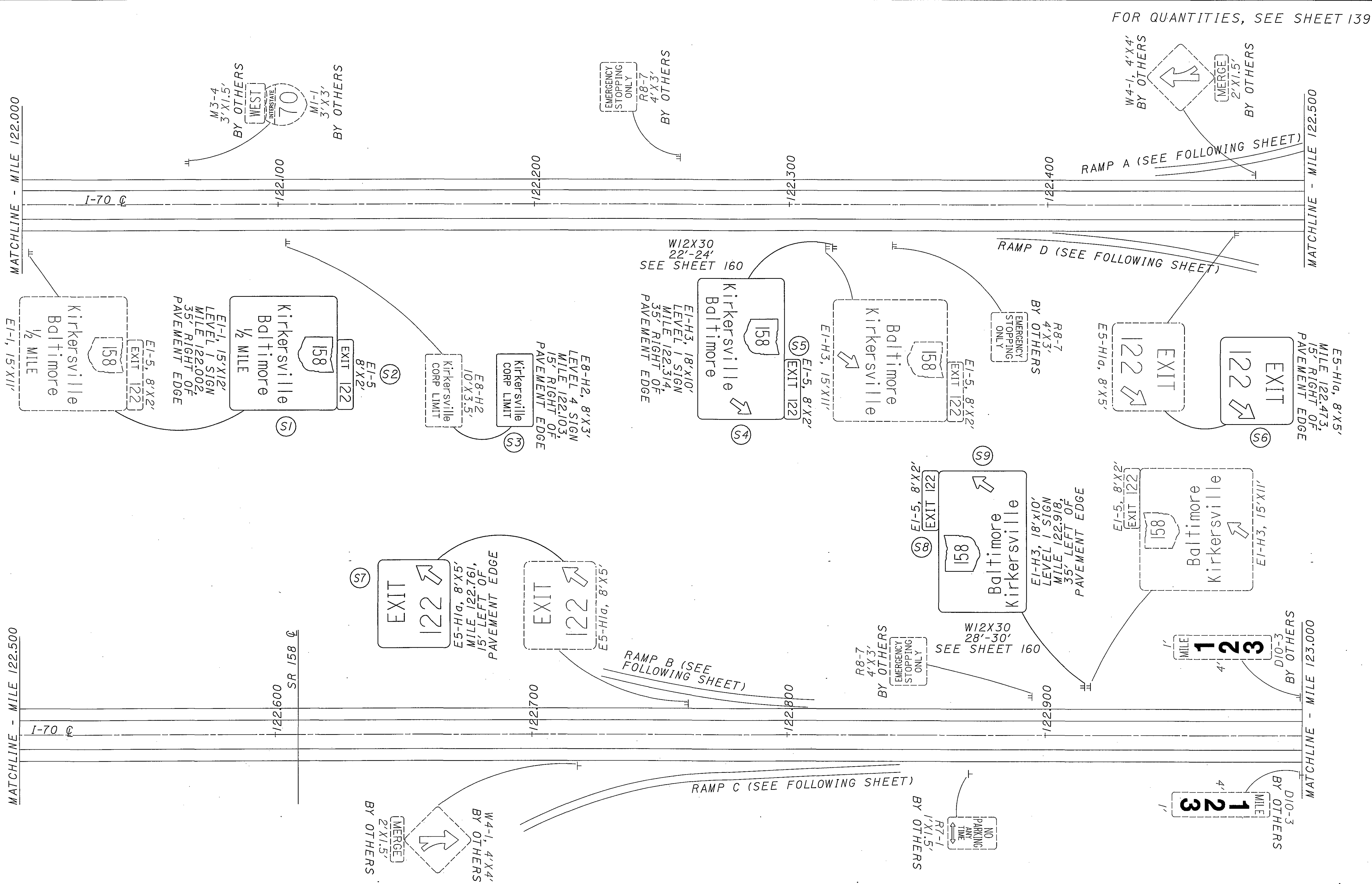

FOR QUANTITIES, SEE SHEET 139

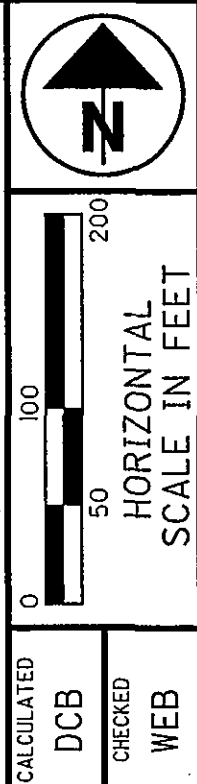

CALCULATED DCB CHECKED WEB

LICKING COUNTY
MILE 122.000 TO MILE 123.000

D05-SIGN-FY2005

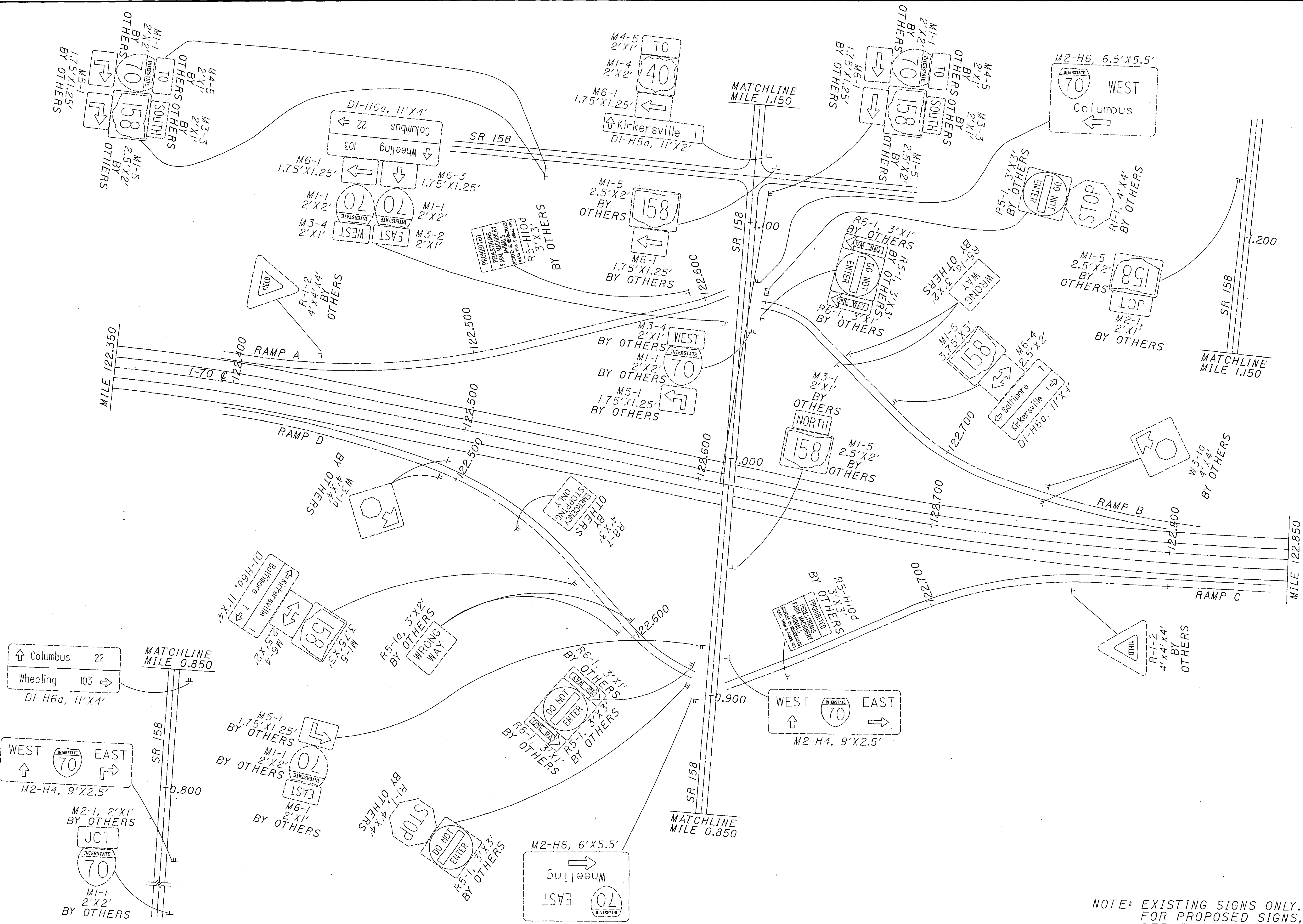

NOTE: EXISTING SIGNS ONLY. FOR PROPOSED SIGNS, SEE FOLLOWING SHEET.

CALCULATED DCB CHECKED WEB

0 50 100 200
HORIZONTAL SCALE IN FEET

LICKING COUNTY SR 158 INTERCHANGE

D05 - SIGN - FY2005

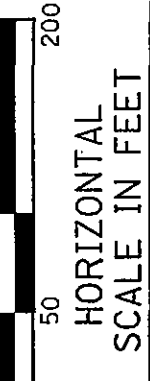

CALCULATED
DCB
CHECKED
WEB

LICKING COUNTY
SR 158 INTERCHANGE

D05 - SIGN - FY2005

08/13/2004 03:54:42 PM m:\proj\0221\505\22 sign inventory\project plans\plansheets\tp018170.dgn

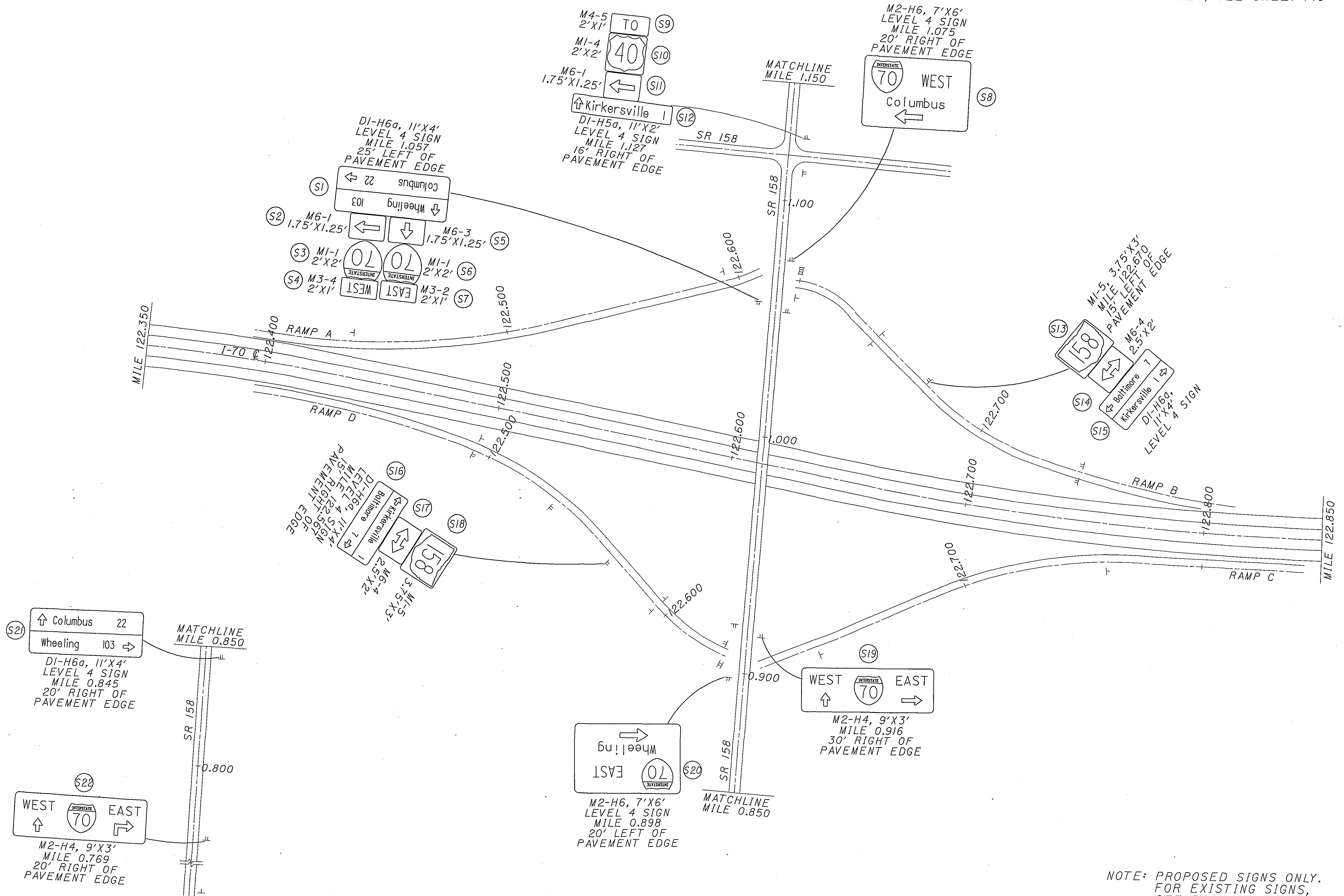

NOTE: PROPOSED SIGNS ONLY.
FOR EXISTING SIGNS,
SEE PREVIOUS SHEET.

MATCHLINE - MILE 123.500

MATCHLINE - MILE 123.000

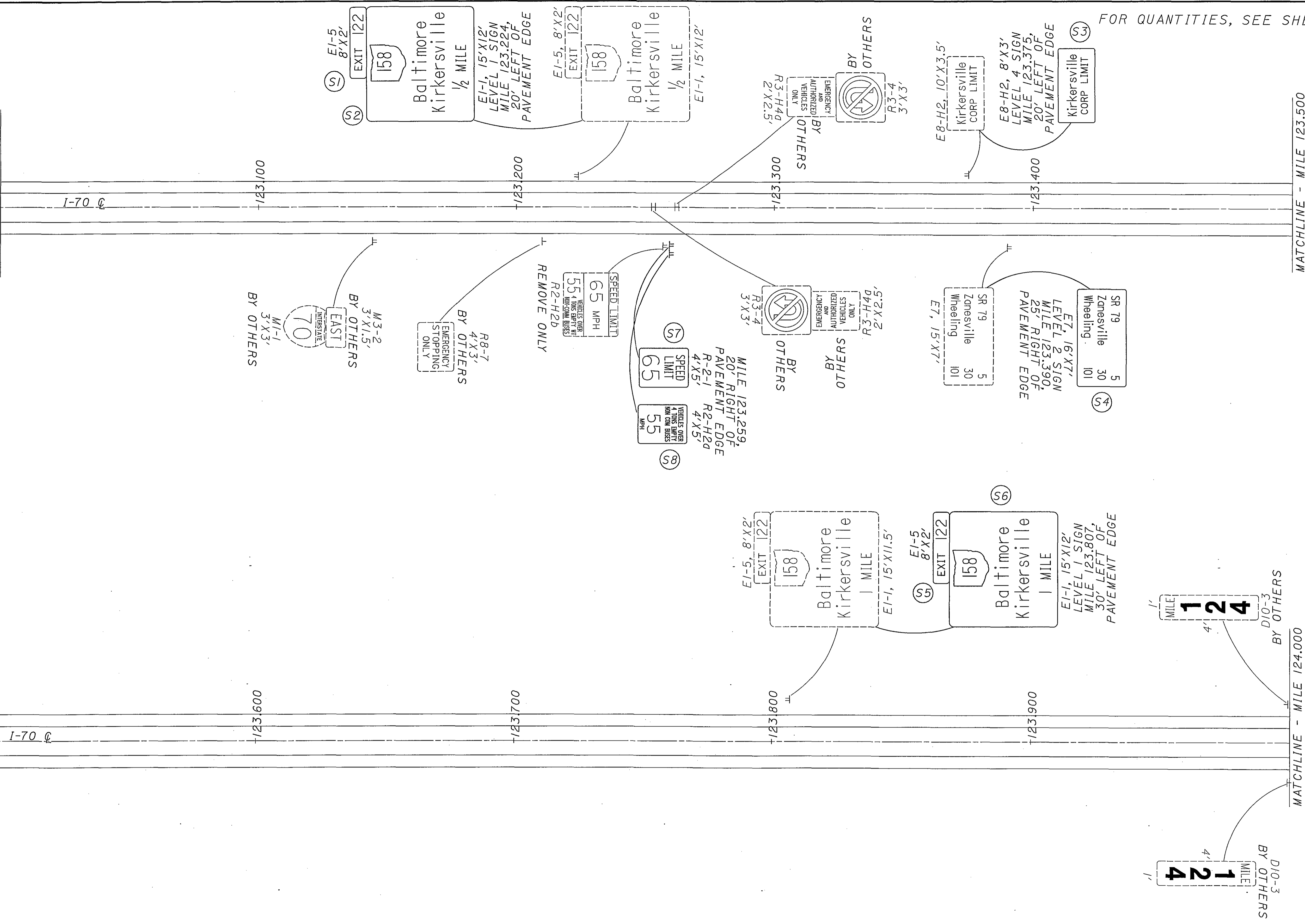

FOR QUANTITIES, SEE SHEET 140

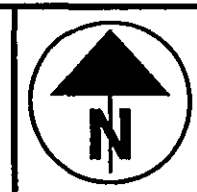

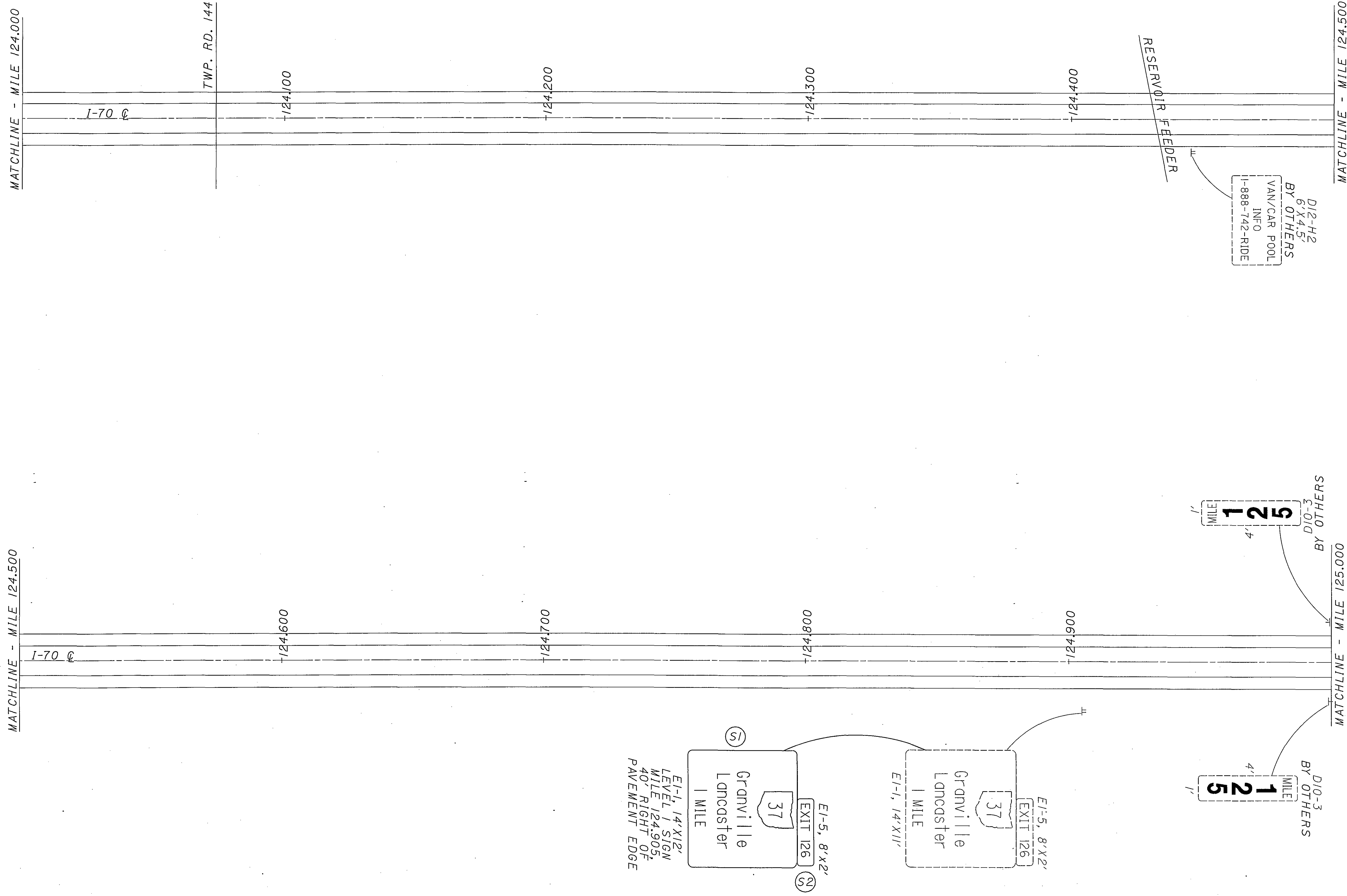

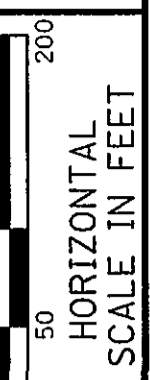

CALCULATED
TAH
CHECKED
WEB

LICKING COUNTY
SR 37 INTERCHANGE

D05-SIGN-FY2005

MATCHLINE - MILE 25.450
(SR 37 - SEE THIS SHEET)

MATCHLINE - MILE 25.450
(SR 37 - SEE THIS SHEET)

MATCHLINE - MILE 25.150
(SR 37 - SEE SHEET 29)

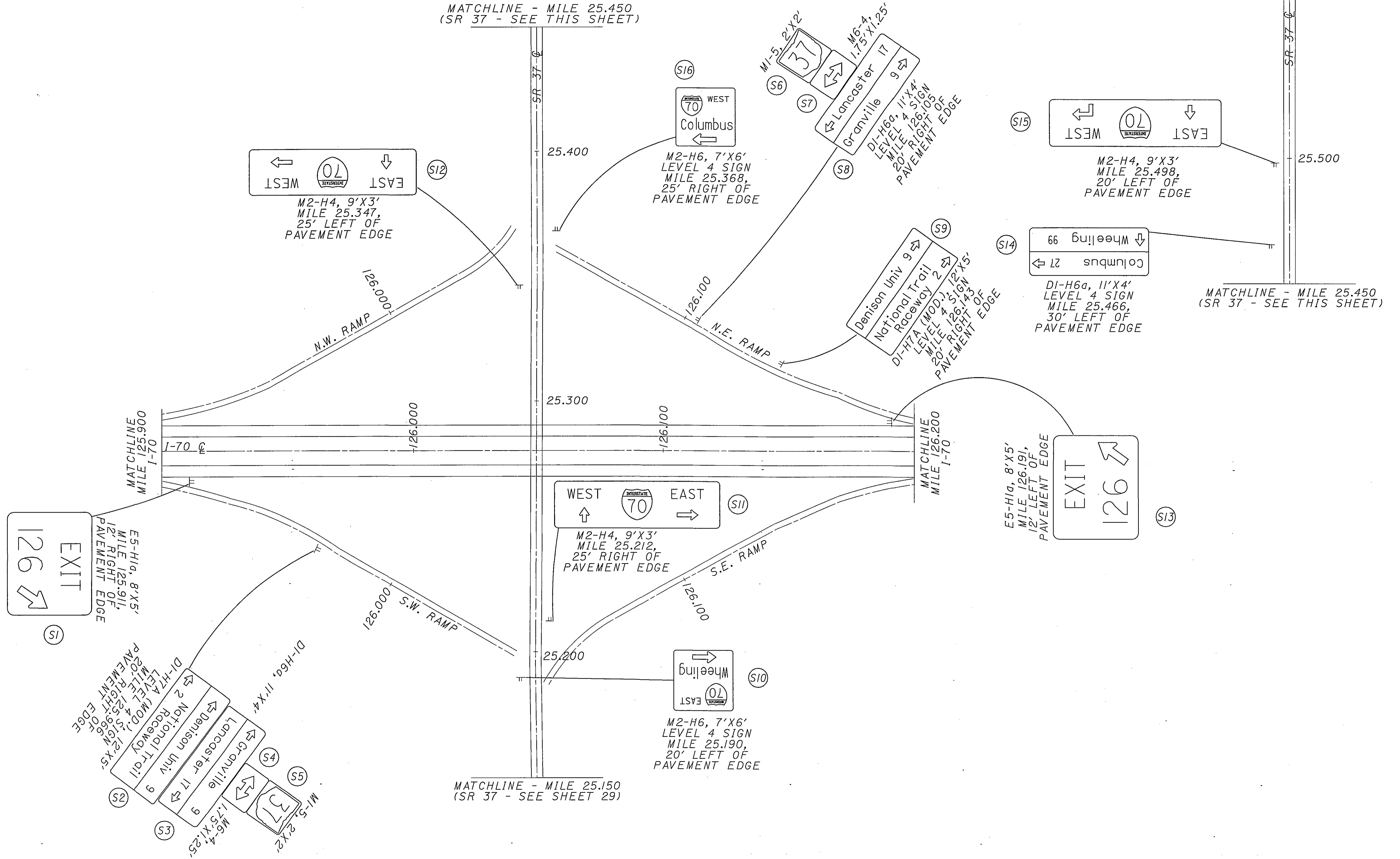

NOTE: PROPOSED SIGNS ONLY.
FOR EXISTING SIGNS,
SEE PREVIOUS SHEET.

08/13/2004 03:44:44 PM m:\pro\0221505\22 sign_inventory\project plans\plansheets\tp023170.dgn

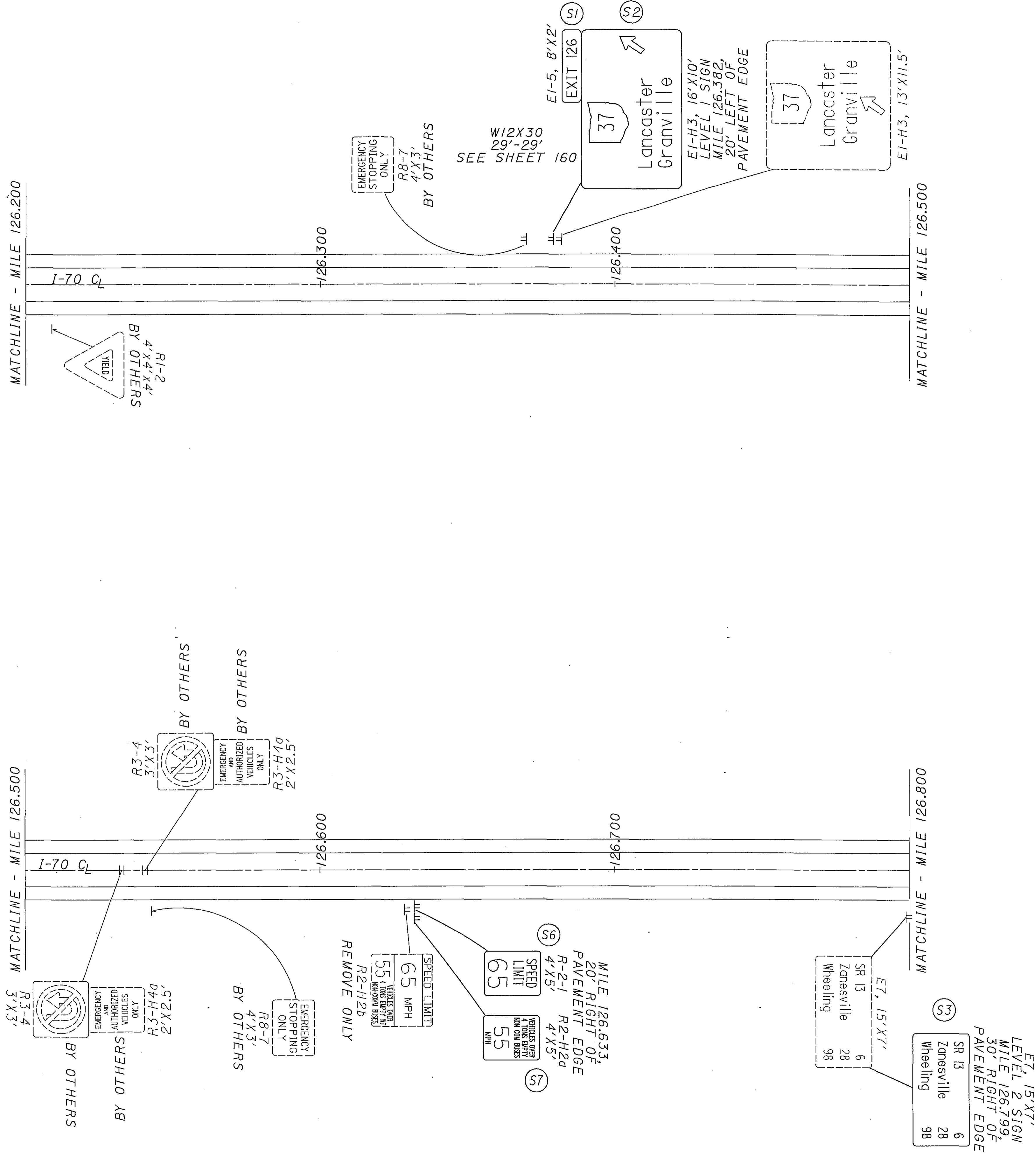

MATCHLINE - MILE 25.150
 (SR 37 - SEE SHEETS 27 AND 28)

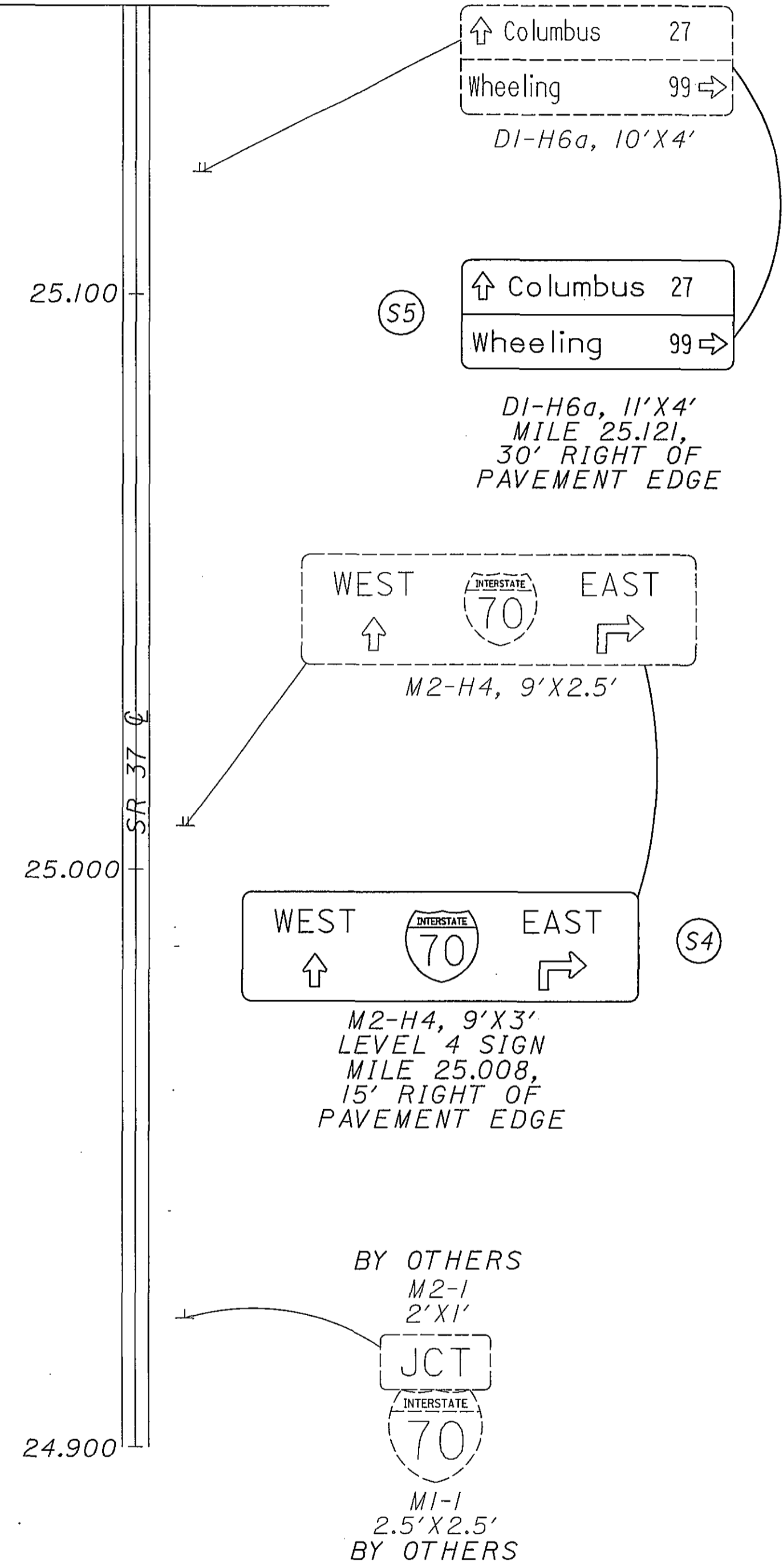

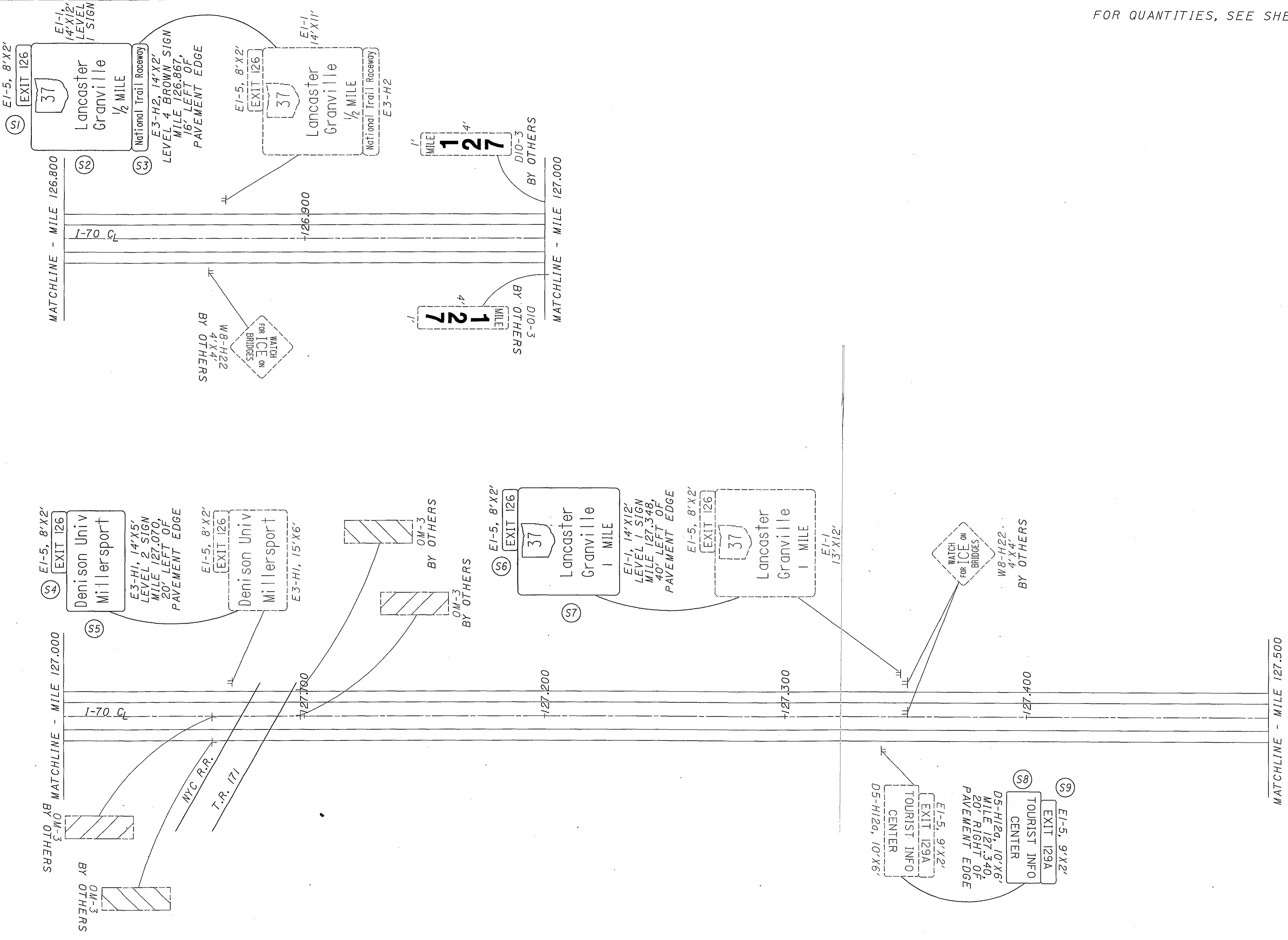

08/13/2004 09:45 AM
m:\pco\022\1505\22 sign inventory\project plans\plansheets\tp028170.dgn

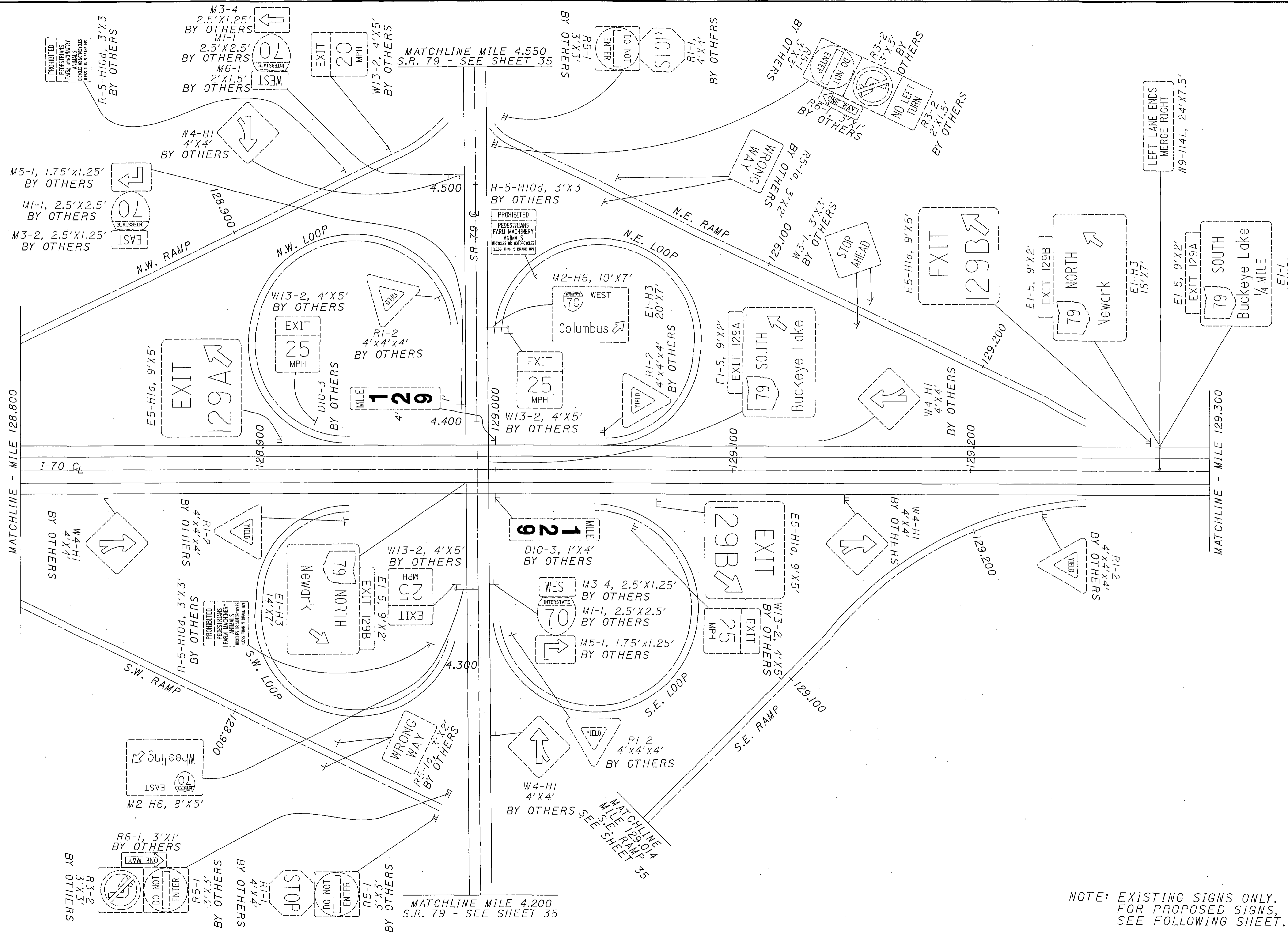

NOTE: EXISTING SIGNS ONLY.
FOR PROPOSED SIGNS,
SEE FOLLOWING SHEET.

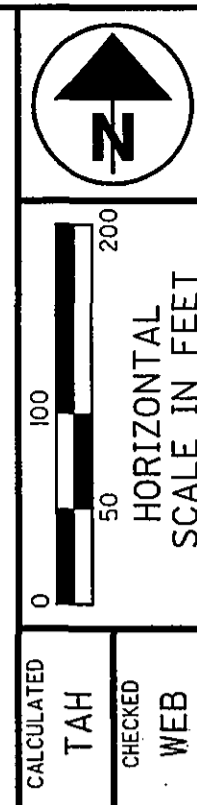

CALCULATED	TAK
CHECKED	WEB

**LICKING COUNTY
SR 79 INTERCHANGE**

D05-SIGN-FY2005



CALCULATED
TAH
CHECKED
WEB

LICKING COUNTY
SR 79 INTERCHANGE

D05-SIGN-FY2005

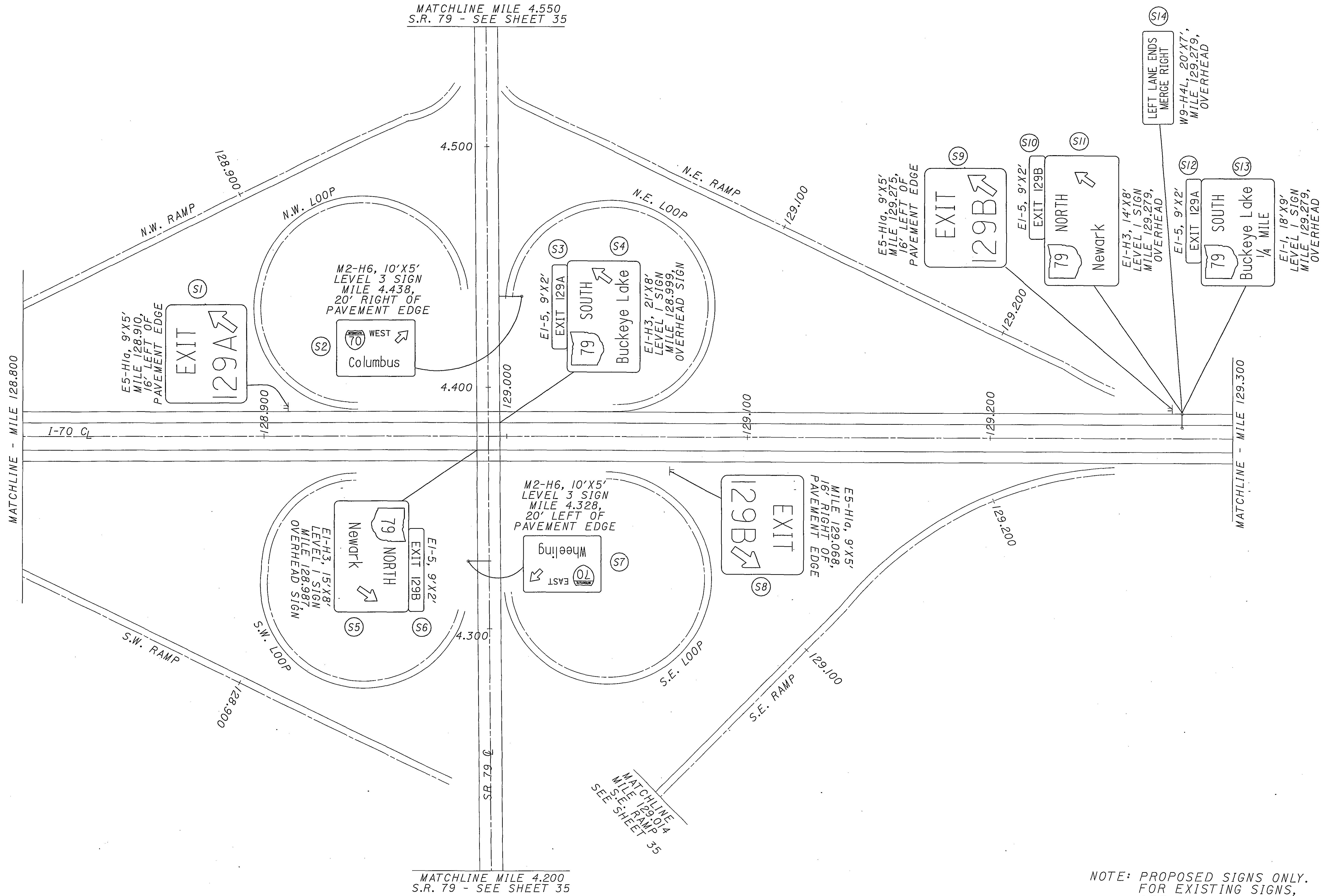

MATCHLINE MILE 4.550
S.R. 79 - SEE SHEET 35

MATCHLINE MILE 4.200
S.R. 79 - SEE SHEET 35

MATCHLINE
MILE 129.014
S.E. RAMP
SEE SHEET 35

NOTE: PROPOSED SIGNS ONLY.
FOR EXISTING SIGNS,
SEE PREVIOUS SHEET.

08/13/2004
03:45:05 PM
m:\proj\0221505\22 sign Inventor\y\project plans\plansheets\tp029170.dgn



0 50 100 200
HORIZONTAL
SCALE IN FEET

CALCULATED
TAM
CHECKED
WEB

LICKING COUNTY
SR 79 INTERCHANGE

D05 - SIGN - FY 2005

MATCHLINE MILE 4.200
S.R. 79 -
SEE SHEETS 33 AND 34

MATCHLINE MILE 129.014
S.E. RAMP
SEE SHEETS
33 AND 34

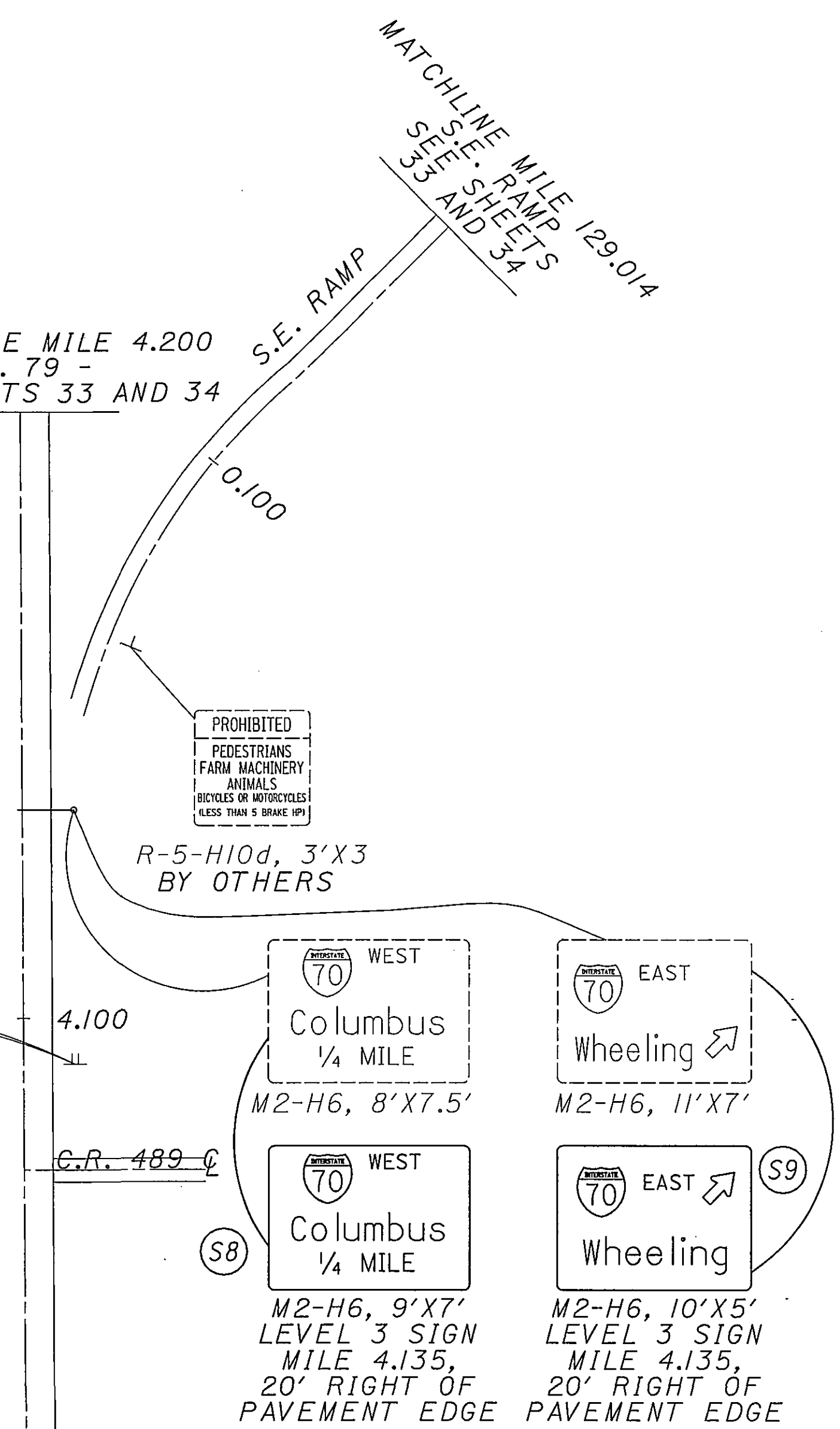

PROHIBITED
PEDESTRIANS
FARM MACHINERY
ANIMALS
BICYCLES OR MOTORCYCLES
(LESS THAN 5 BRAKE IPI)

R-5-H10d, 3'X3'
BY OTHERS

4.100

G.R. 489

4.000

SR 79

M1-1, 2.5'X2.5'
BY OTHERS

M2-1, 2'X1'
BY OTHERS

4.800

DI-H5a, 14'x5'
LEVEL 3 SIGN
MILE 4.677,
20' LEFT OF
PAVEMENT EDGE

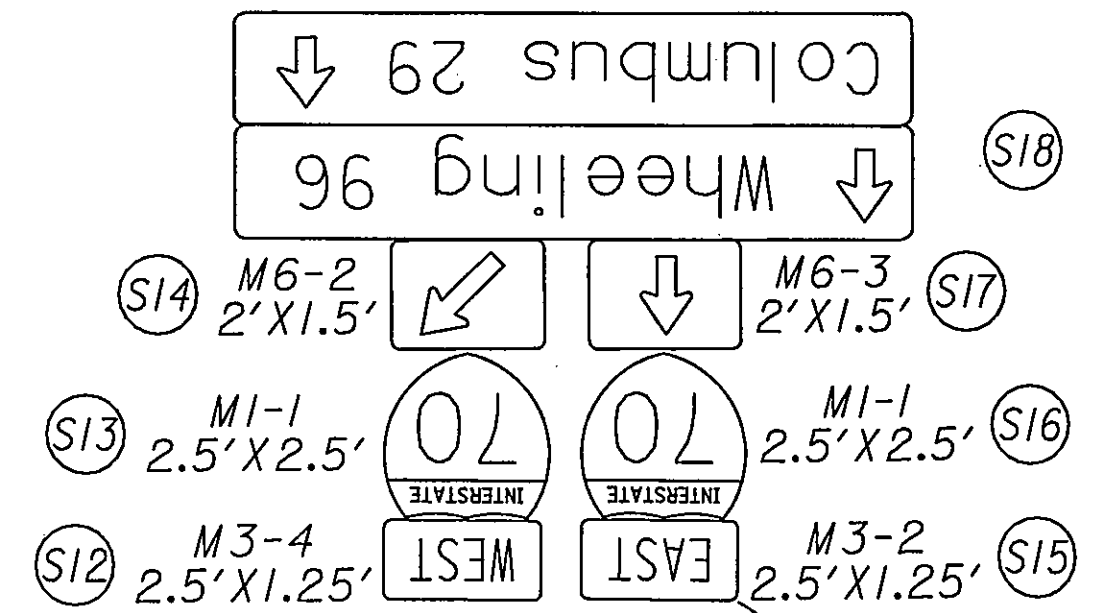

4.700

DI-H5a, 15'X6'

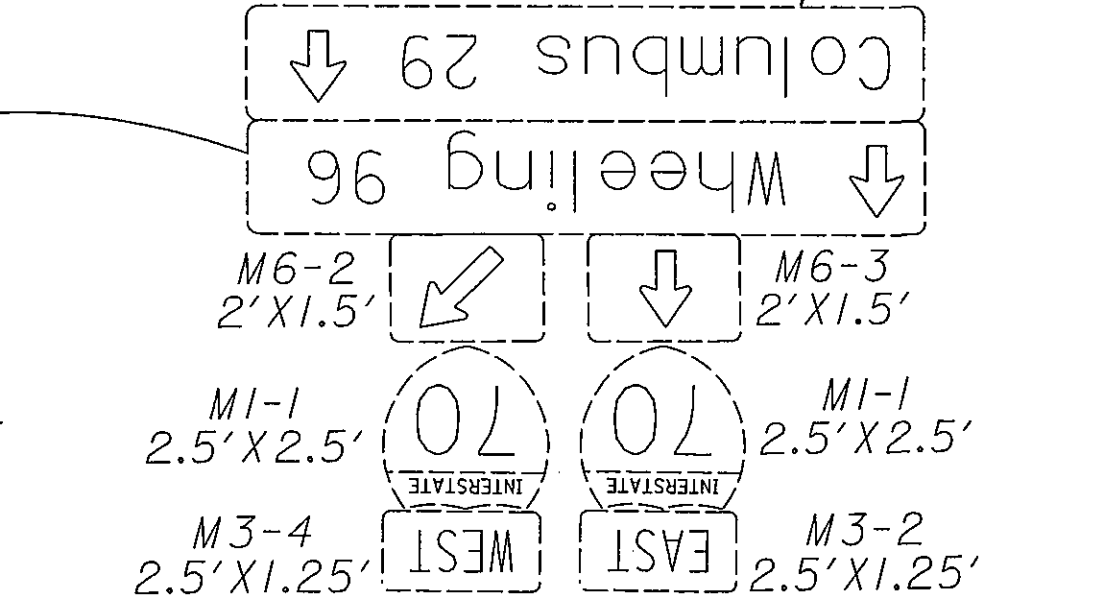

4.600

SOUTH FORK
LICKING RIVER

MATCHLINE MILE 4.550
S.R. 79
SEE SHEETS 33 AND 34

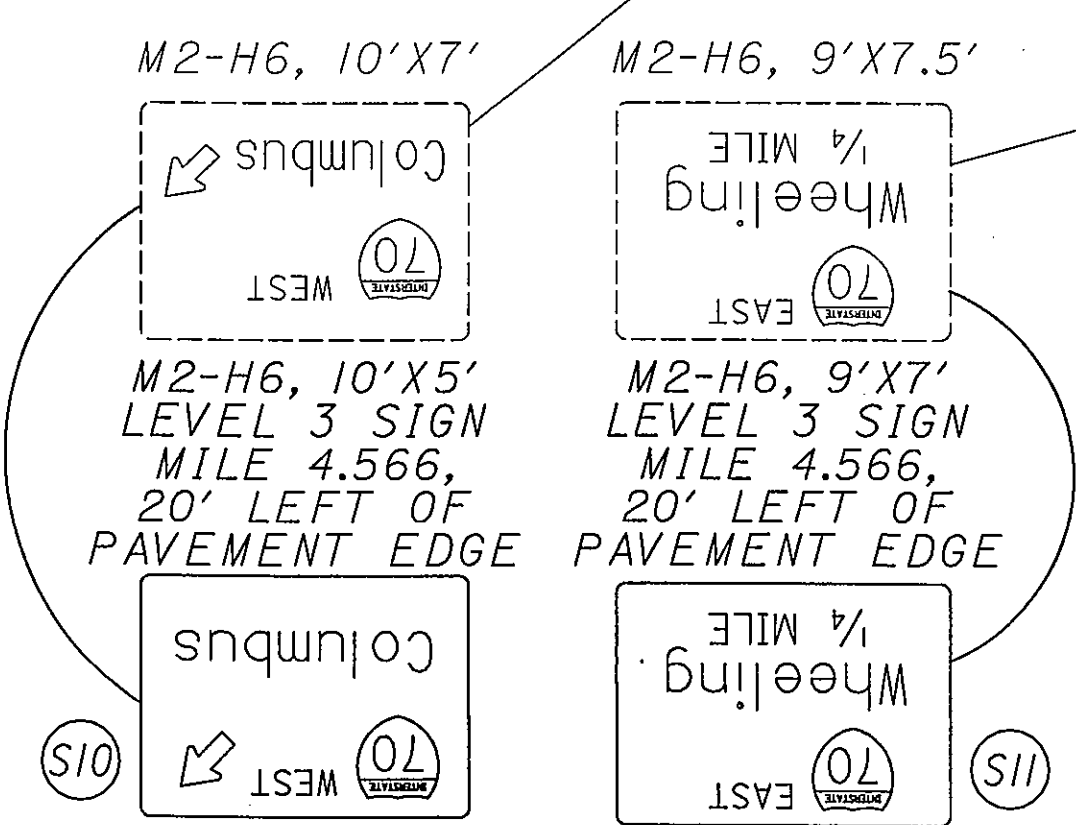

08/13/2004 03:54:46 PM m:\proj\0221\B05\22 sign inventory\project plans\plansheets\tp030170.dgn

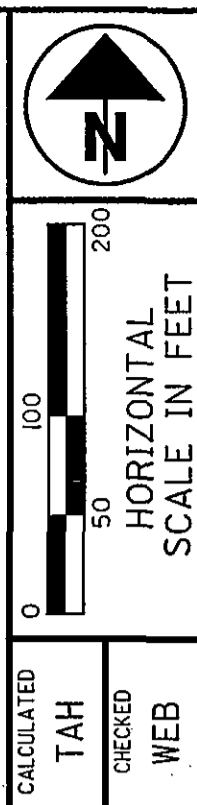
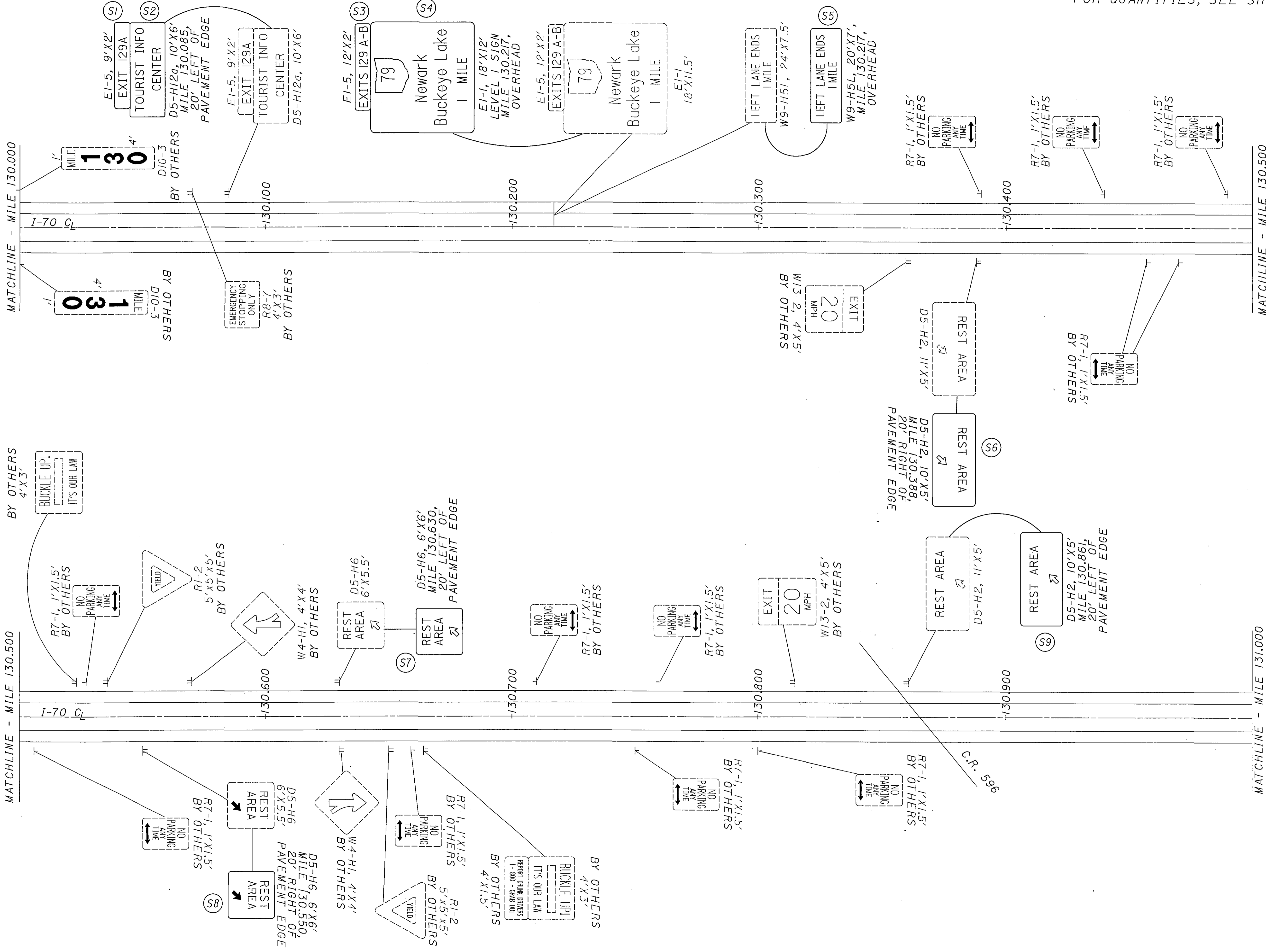

FOR QUANTITIES, SEE SHEET 142

CALCULATED BY T.A.H.
 CHECKED BY WEB

LICKING COUNTY
MILE 130.000 TO MILE 131.000

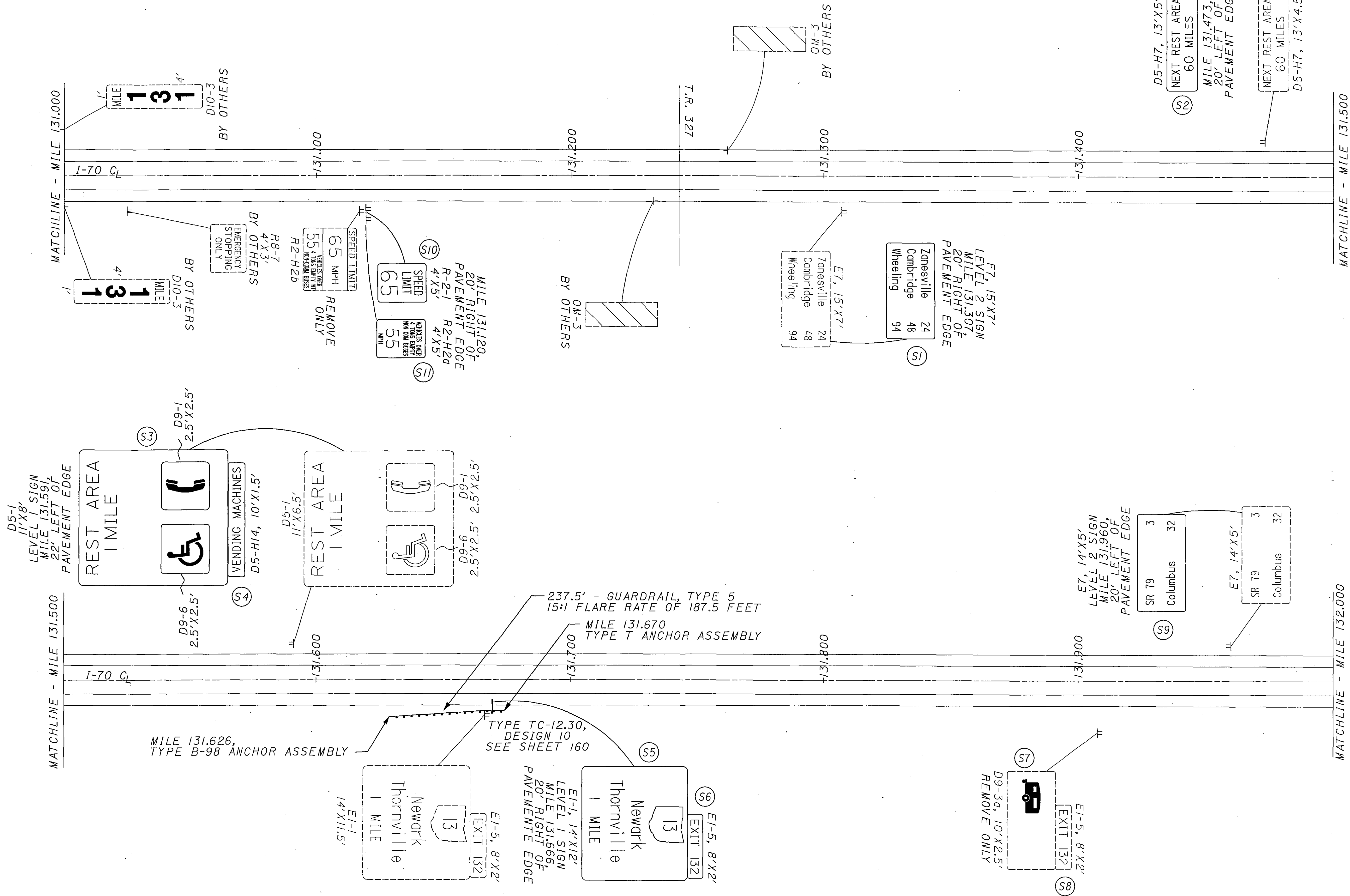

FOR QUANTITIES, SEE SHEET 143

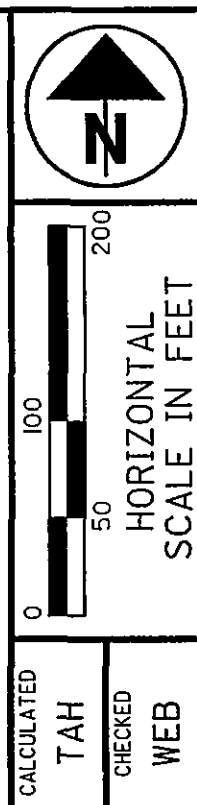

CALCULATED
 T.A.H.
 CHECKED
 WEB

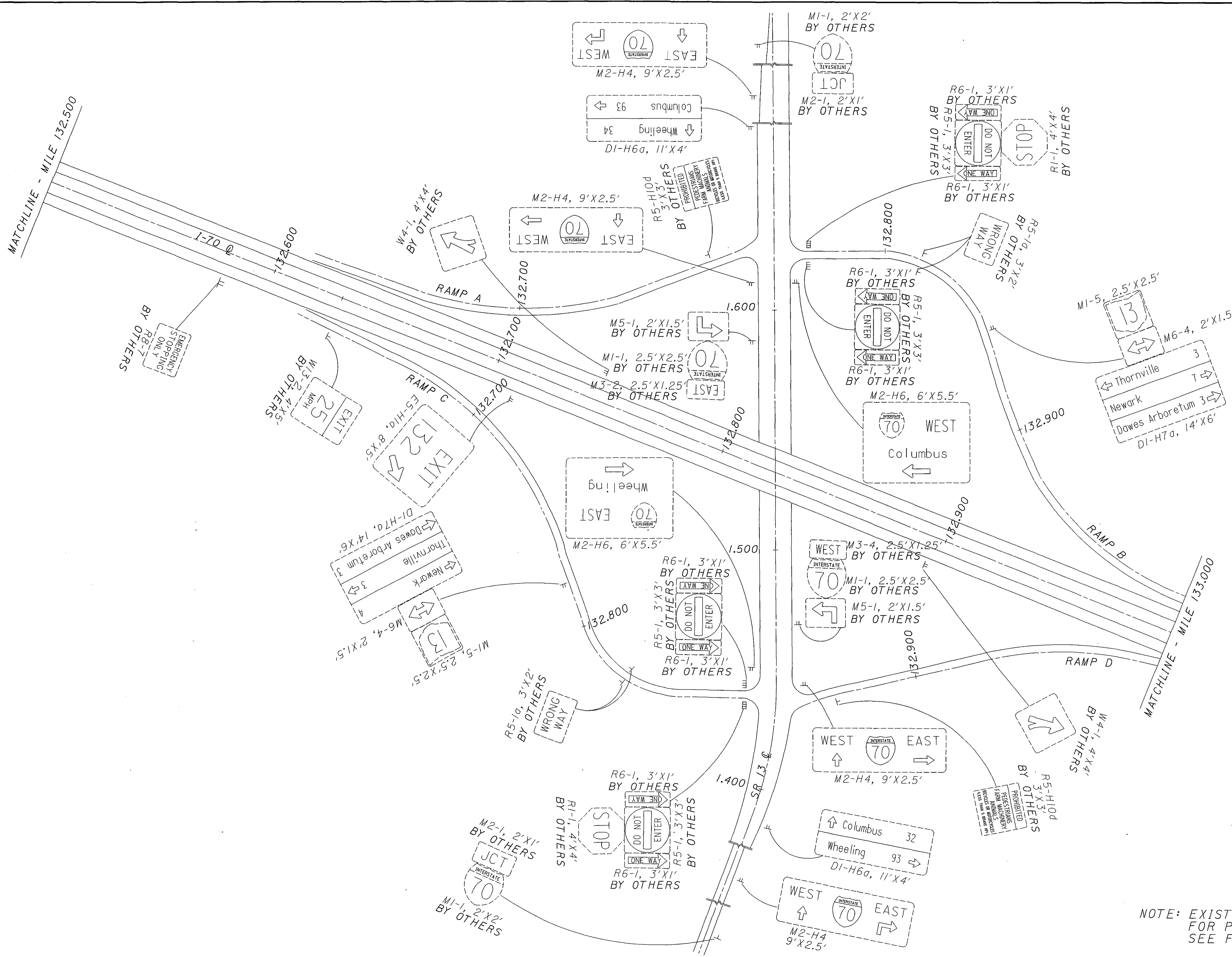

NOTE: EXISTING SIGNS ONLY.
 FOR PROPOSED SIGNS,
 SEE FOLLOWING SHEET.

CALCULATED
 TAHA
 CHECKED
 WEB

0 50 100 200
 HORIZONTAL
 SCALE IN FEET

LICKING COUNTY
 SR 13 INTERCHANGE

D05 - SIGN - FY 2005

MATCHLINE - MILE 135.500

I-70

T.R. 328

+135.600

+135.700

+135.800

+135.900

MATCHLINE - MILE 136.000

MATCHLINE - MILE 135.000

I-70

+135.100

+135.200

+135.300

+135.400

MATCHLINE - MILE 135.500

135
MILE
D10-3
BY OTHERS

135
MILE
D10-3
BY OTHERS

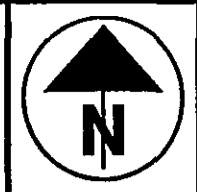

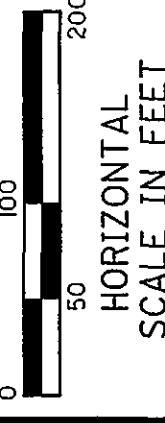

CALCULATED
TAH
CHECKED
WEB

**LICKING COUNTY
MILE 136.000 TO MILE 137.000**

D05 - SIGN - FY2005

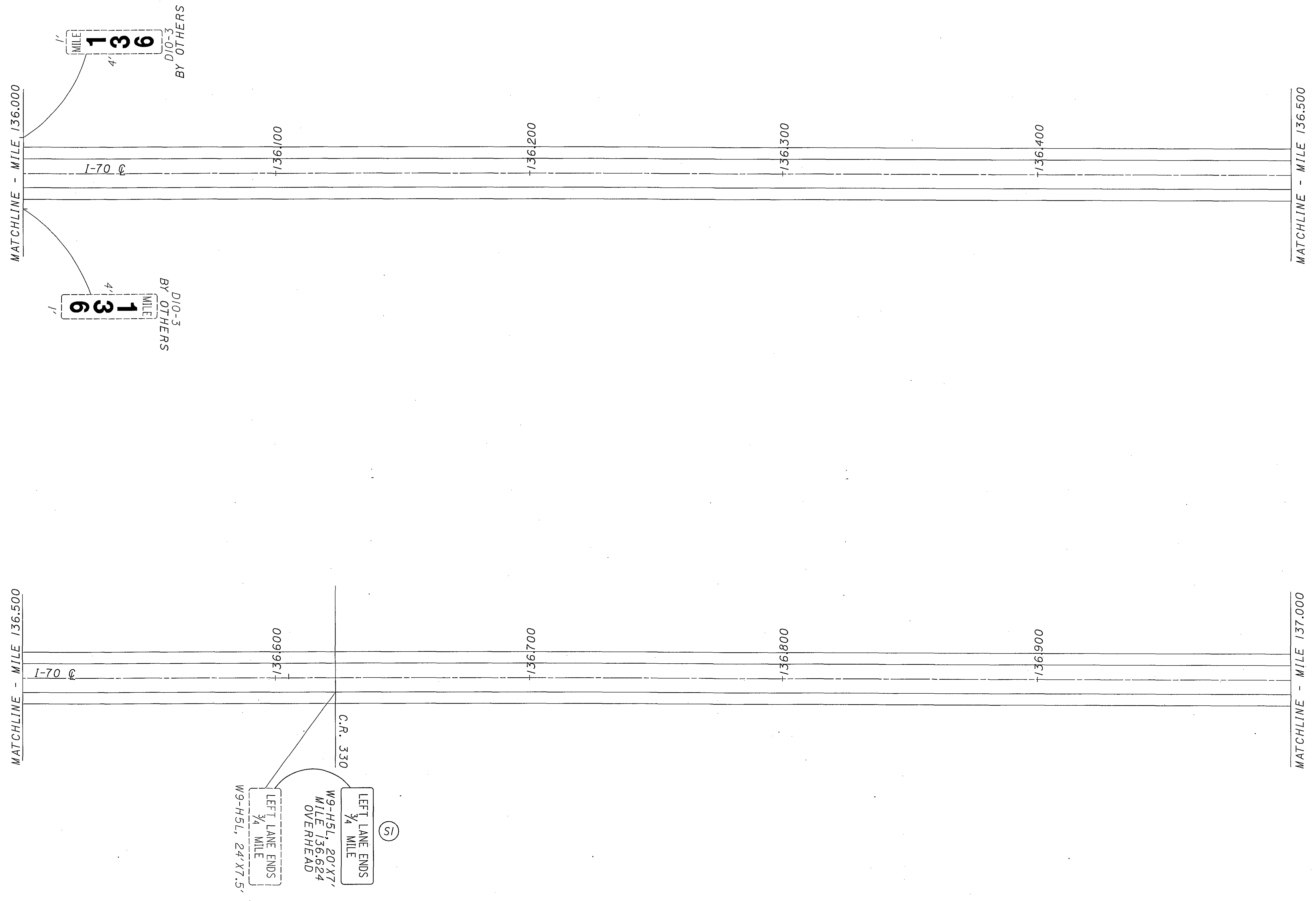

08/13/2004
03:44:49 PM
m:\proj\0221\505122_sign_inventory\project_plans\plansheets\tp040170.dgn



CALCULATED
T.A.H.
CHECKED
WEB

LICKING COUNTY
MILE 137.000 TO MILE 138.000

D05 - SIGN - FY 2005

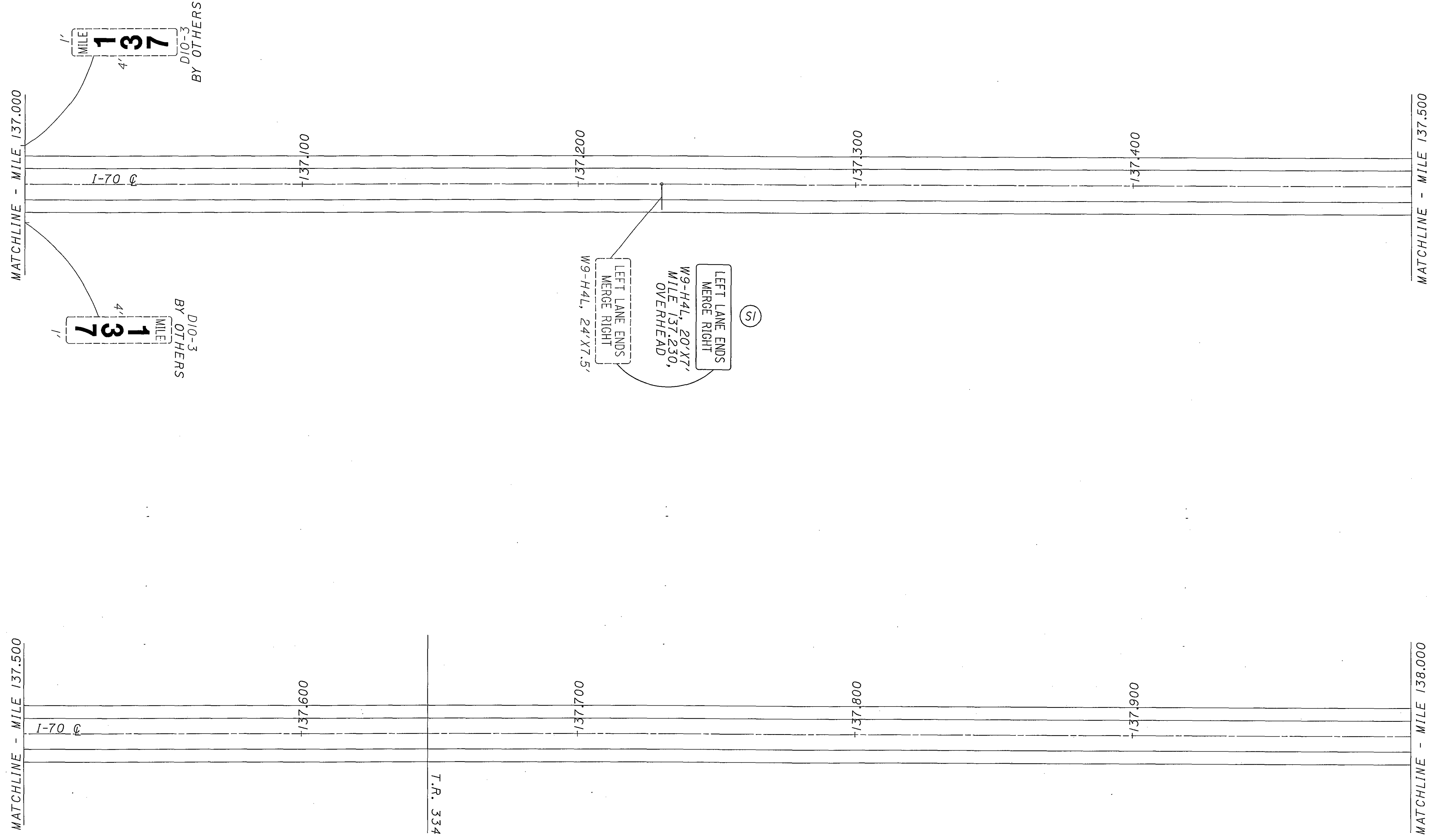

MATCHLINE - MILE 138.500

1-70 @

+138.600

+138.700

+138.800

+138.900

MATCHLINE - MILE 139.000

MATCHLINE - MILE 138.000

1-70 @

+138.100

+138.200

+138.300

+138.400

MATCHLINE - MILE 138.500

1/4" MILE
138
D10-3
BY OTHERS

1/4" MILE
138
D10-3
BY OTHERS

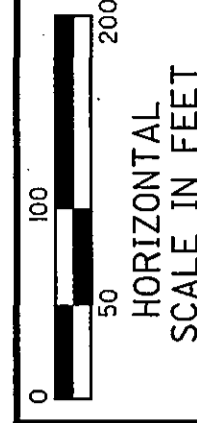
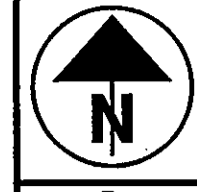

CALCULATED
T.A.H.
CHECKED
WEB

LICKING COUNTY
MILE 139.000 TO MILE 140.000

D05 - SIGN - FY 2005

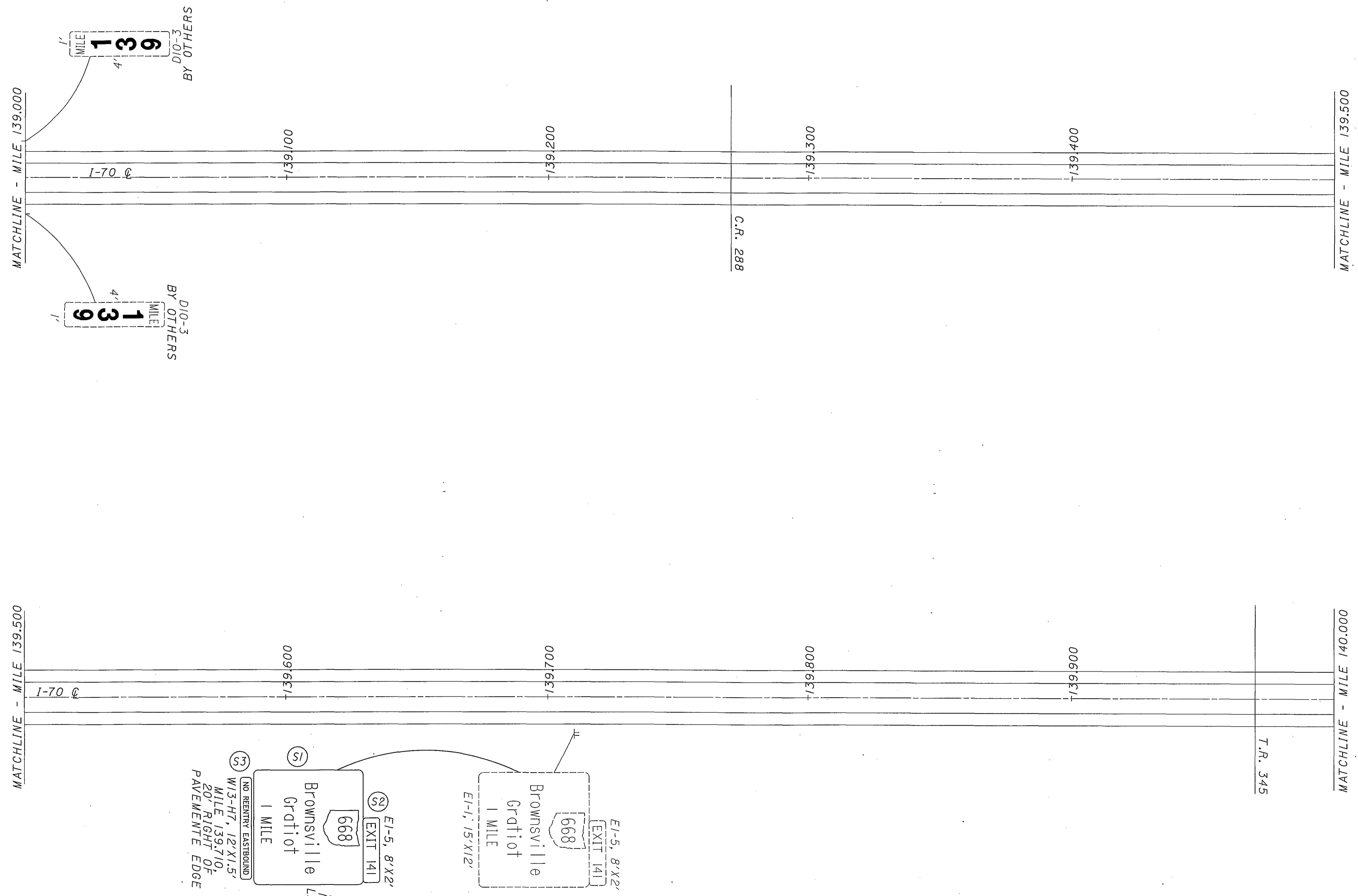

(S) NO REENTRY EASTBOUND
 W13-H7, 12'x1.5'
 MILE 139.710,
 20' RIGHT OF
 PAVEMENT EDGE

(S) E1-1, 15'x12' LEVEL 1 SIGN

(S) E1-5, 8'x2' EXIT 141

(S) Brownsville Gratiot 1 MILE

(S) 668

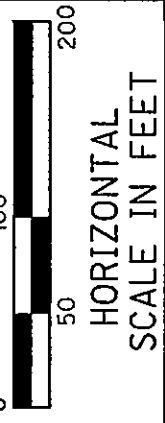

CALCULATED
TAM
CHECKED
WEB

LICKING COUNTY
SR 668 INTERCHANGE

D05 - SIGN - FY 2005

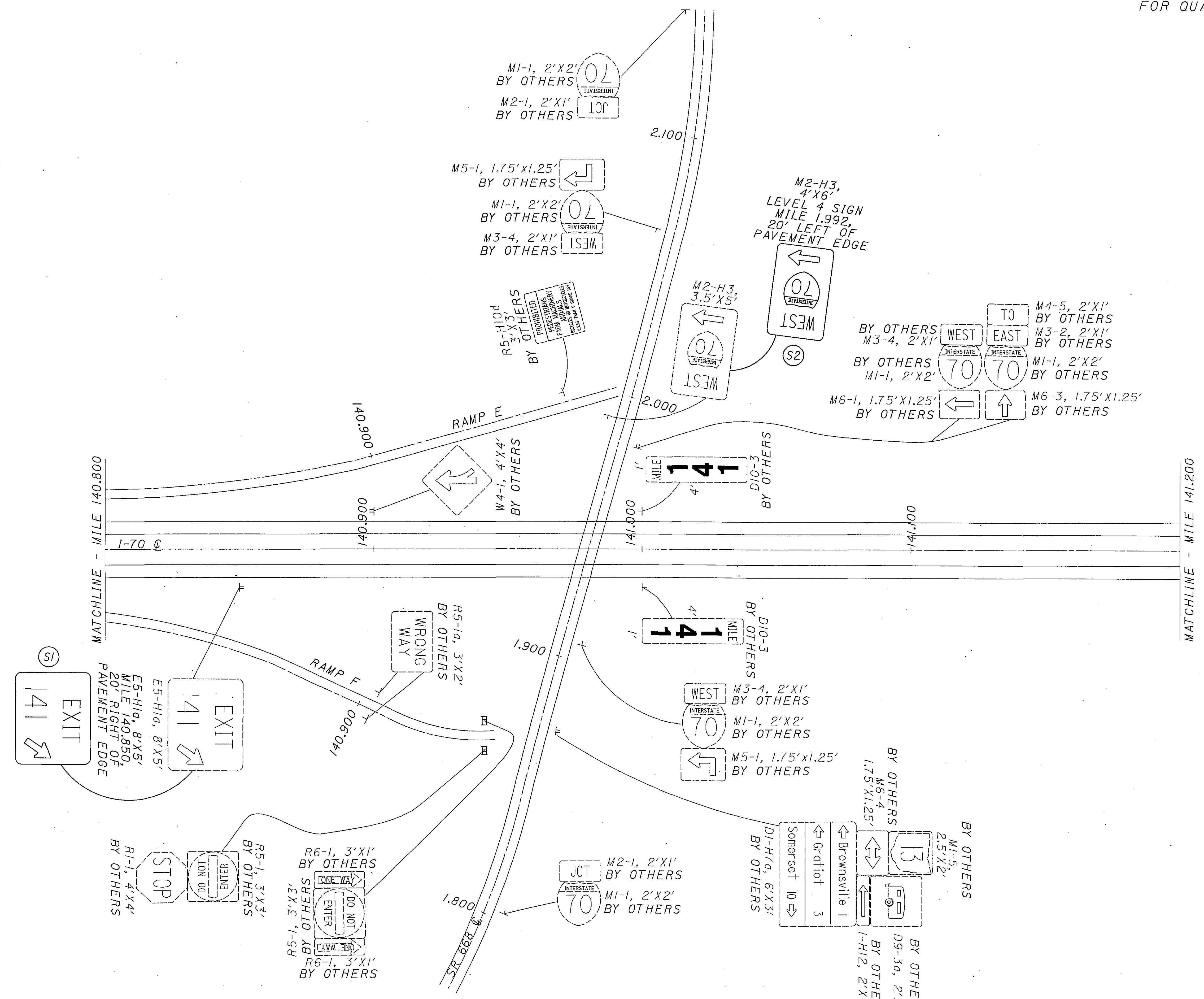

08/13/2004 03:54:20 PM m:\proj\022\1505\22 sign inventory\project plans\plansheets\fp045170.dgn

MATCHLINE - MILE 141.500

I-70

141.600

141.700

141.800

141.900

MATCHLINE - MILE 142.000

MATCHLINE - MILE 141.200

I-70

141.300

141.400

MATCHLINE - MILE 141.500



MATCHLINE - MILE 142.500

I-70 CL

142.600

142.700

MATCHLINE - MILE 142.800

MATCHLINE - MILE 142.000

I-70 CL

142.100

142.200

142.300

142.400

MATCHLINE - MILE 142.500

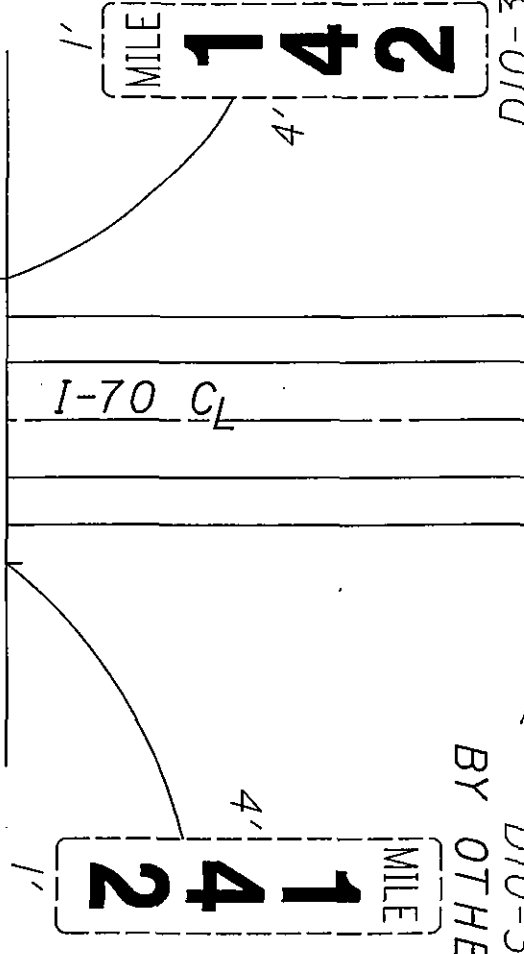

D10-3
BY OTHERS

D10-3
BY OTHERS

C.R. 7

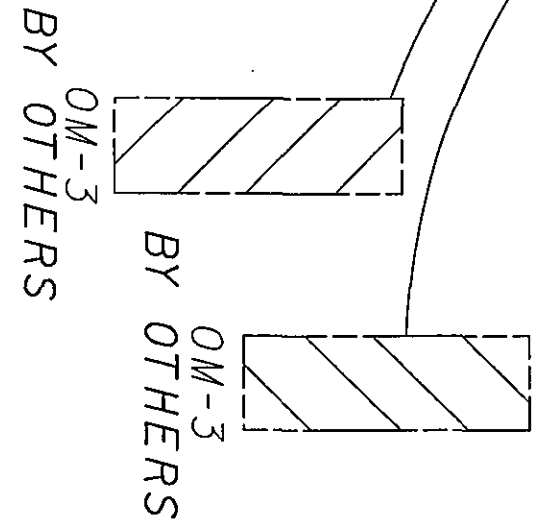

OM-3
BY OTHERS

OM-3
BY OTHERS

STREAM

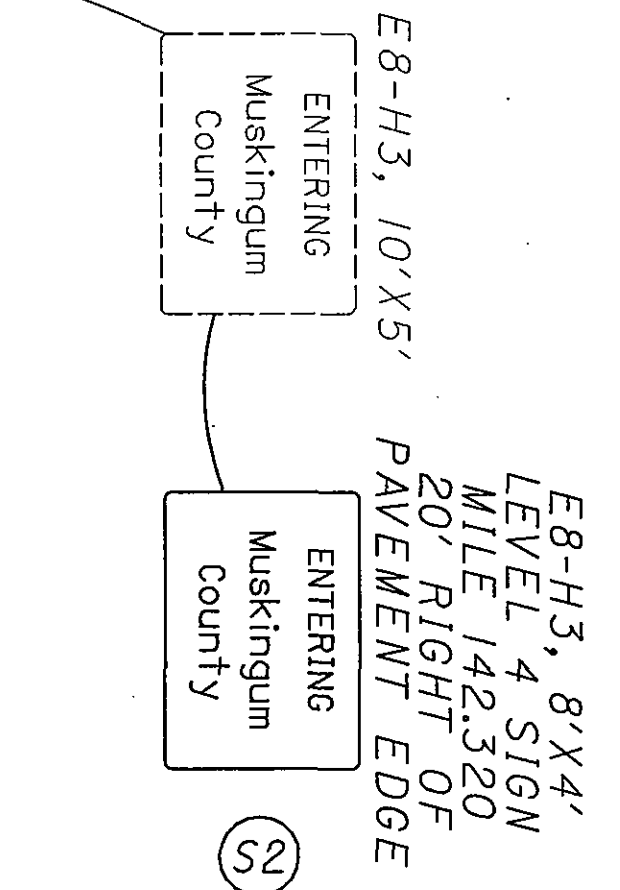
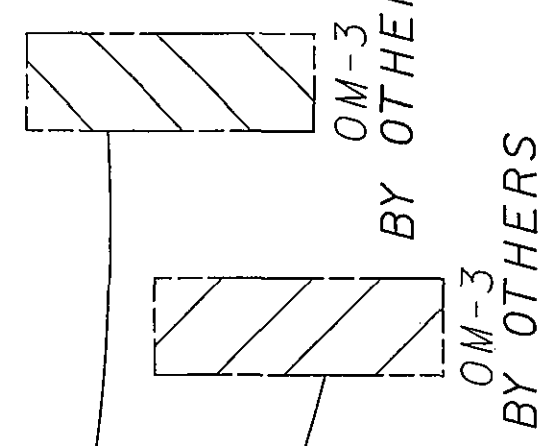

E8-H3, 10'X5'
ENTERING
Muskingum
County

E8-H3, 8'X4'
LEVEL 4 SIGN
MILE 142.320
20' RIGHT OF
PAVEMENT EDGE

S2

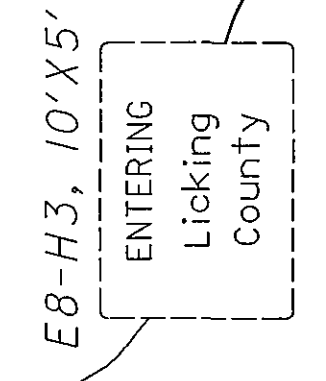

E8-H3, 10'X5'
ENTERING
Licking
County

E8-H3, 6'X4'
LEVEL 4 SIGN
MILE 142.370
20' LEFT OF
PAVEMENT EDGE

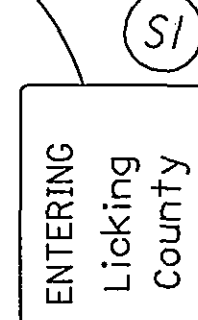

ENTERING
Licking
County

FOR QUANTITIES, SEE SHEET 144

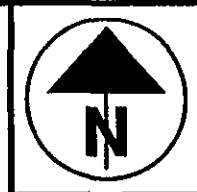

MATCHLINE - MILE 145.000

I-70 @

+145.100

+145.200

+145.300

+145.400

MATCHLINE - MILE 145.500

MATCHLINE - MILE 144.500

I-70 @

+144.600

+144.700

+144.800

+144.900

MATCHLINE - MILE 145.000

OM-3
BY
OTHERS

OM-3
BY
OTHERS

KENT RUN

OM-3
BY
OTHERS

OM-3
BY
OTHERS

D10-3
BY OTHERS

MILE
145

D10-3
BY OTHERS
MILE
145

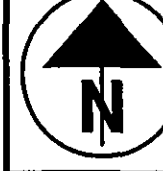

MATCHLINE - MILE 145.500

I-70

BY OTHERS

R3-4
3'X3'

BY OTHERS

R3-H4d
2'X2.5'

EMERGENCY
AUTHORIZED
VEHICLES
ONLY

R3-4
3'X3'

EMERGENCY
AUTHORIZED
VEHICLES
ONLY

R3-H4d
2'X2.5'

EMERGENCY
AUTHORIZED
VEHICLES
ONLY

R3-4
3'X3'

EMERGENCY
AUTHORIZED
VEHICLES
ONLY

BY OTHERS

R3-H4d
2'X2.5'

EMERGENCY
AUTHORIZED
VEHICLES
ONLY

R3-4
3'X3'

EMERGENCY
AUTHORIZED
VEHICLES
ONLY

R3-H4d
2'X2.5'

EMERGENCY
AUTHORIZED
VEHICLES
ONLY

R3-4
3'X3'

EMERGENCY
AUTHORIZED
VEHICLES
ONLY

BY OTHERS

MATCHLINE - MILE 146.000

I-70

145.600

145.700

145.800

145.900

146.000

146.200

146.300

146.400

MATCHLINE - MILE 146.000

BY OTHERS

OM-3
BY OTHERS

OM-3
BY OTHERS

145.700

145.800

145.900

146.000

146.200

146.300

146.400

C.R. 28

146.300

145.800

145.900

146.000

146.200

146.300

146.400

146.500

146.600

OM-3
BY OTHERS

OM-3
BY OTHERS

OM-3
BY OTHERS

OM-3
BY OTHERS

OM-3
BY OTHERS

OM-3
BY OTHERS

OM-3
BY OTHERS

OM-3
BY OTHERS

OM-3
BY OTHERS

OM-3
BY OTHERS

OM-3
BY OTHERS

OM-3
BY OTHERS

OM-3
BY OTHERS

OM-3
BY OTHERS

MATCHLINE - MILE 146.500

BY OTHERS

D10-3
MILE

146

4'

1'

D10-3
BY OTHERS

D10-3
MILE

146

4'

1'

MATCHLINE - MILE 147.000

I-70 ☉

147.100

147.200

147.300

C.R. 34

147.400

MATCHLINE - MILE 147.500

MATCHLINE - MILE 146.500

I-70 ☉

146.600

146.700

146.800

146.900

MATCHLINE - MILE 147.000

D10-3
BY OTHERS

MILE
147
4' 1'

D10-3
BY OTHERS

MILE
147
4' 1'

MATCHLINE - MILE 147.500

I-70

+147.600

+147.700

+147.800

+147.900

MATCHLINE - MILE 148.000

MATCHLINE - MILE 148.000

I-70

+148.100

+148.200

+148.300

+148.400

MATCHLINE - MILE 148.500

BY OTHERS
R3-4
3'X3'
EMERGENCY
AUTHORIZED
VEHICLES
ONLY
R3-H4g
2'X2.5'
BY OTHERS

BY OTHERS
R3-4
3'X3'
EMERGENCY
AUTHORIZED
VEHICLES
ONLY
R3-H4g
2'X2.5'
BY OTHERS

D10-3
BY OTHERS
MILE
148
4'
1'

D10-3
BY OTHERS
MILE
148
4'
1'

MATCHLINE - MILE 148.500

I-70 ☺

+148,600

+148,700

+148,800

+148,900

MATCHLINE - MILE 149.000

MATCHLINE - MILE 149.000

I-70 ☺

+149,100

+149,200

+149,300

+149,400

MATCHLINE - MILE 149.500

D10-3
BY OTHERS

MILE
149
4' 1'

D10-3
BY OTHERS

MILE
149
4' 1'

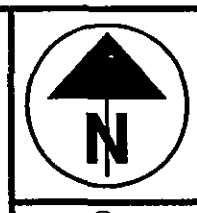

MATCHLINE - MILE 150.000

I-70

150.100

150.200

150.300

150.400

MATCHLINE - MILE 150.500

MATCHLINE - MILE 149.500

I-70

149.600

149.700

149.800

149.900

MATCHLINE - MILE 150.000

OTHERS

OTHERS

OM-3

BY

OTHERS

OM-3

BY

OTHERS

T.R. 271

OM-3

BY

OTHERS

OM-3

BY

OTHERS

D10-3
BY OTHERS

MILE
150

4'

1'

D10-3
BY OTHERS

MILE
150

4'

1'

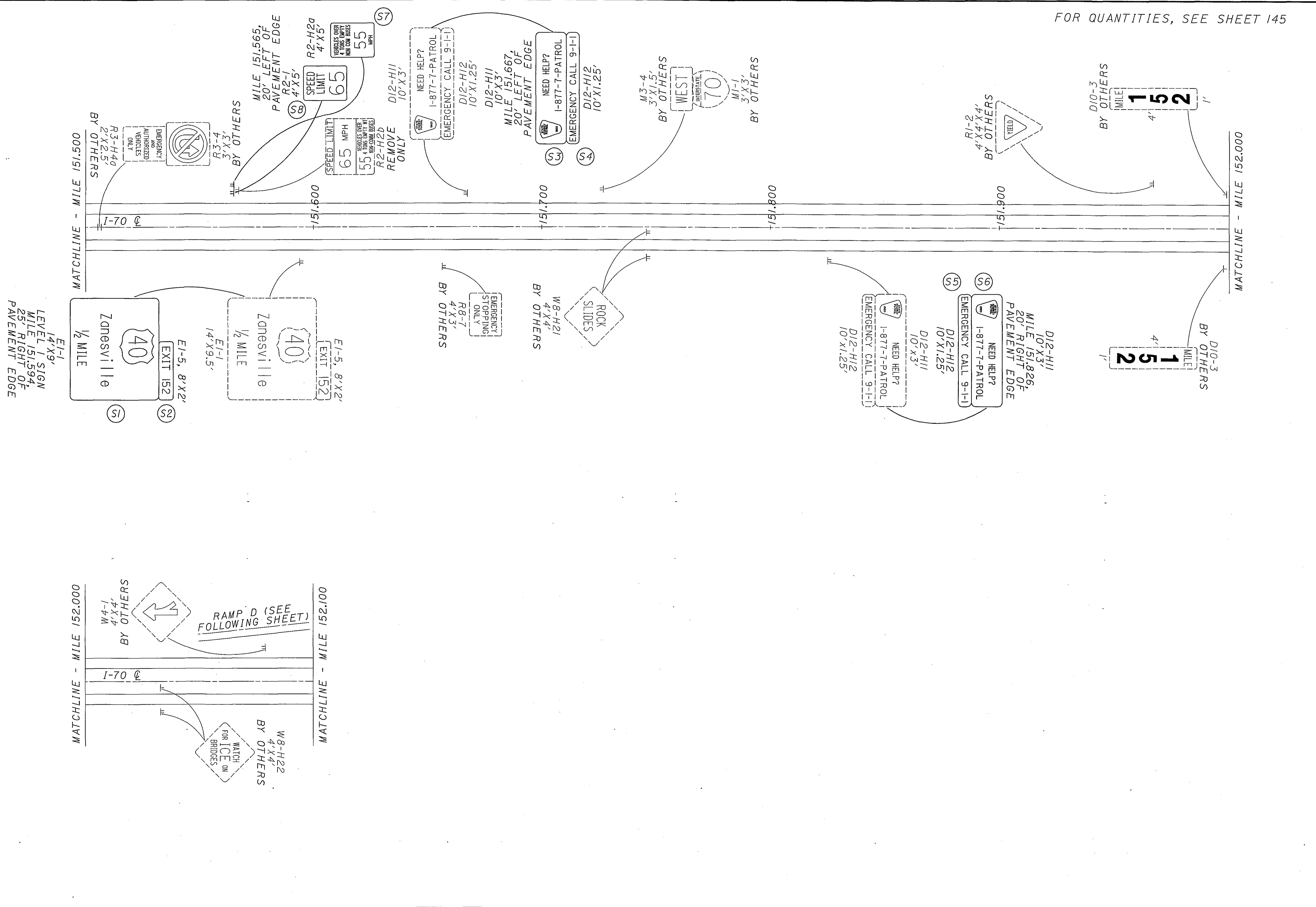

FOR QUANTITIES, SEE SHEET 145

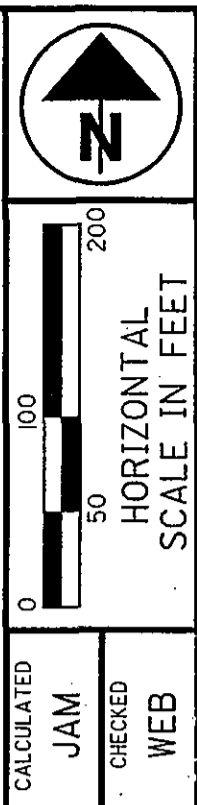

CALCULATED
 JAM
 CHECKED
 WEB

MUSKINGUM COUNTY
MILE 151.500 TO MILE 152.100

D05-SIGN-FY2005

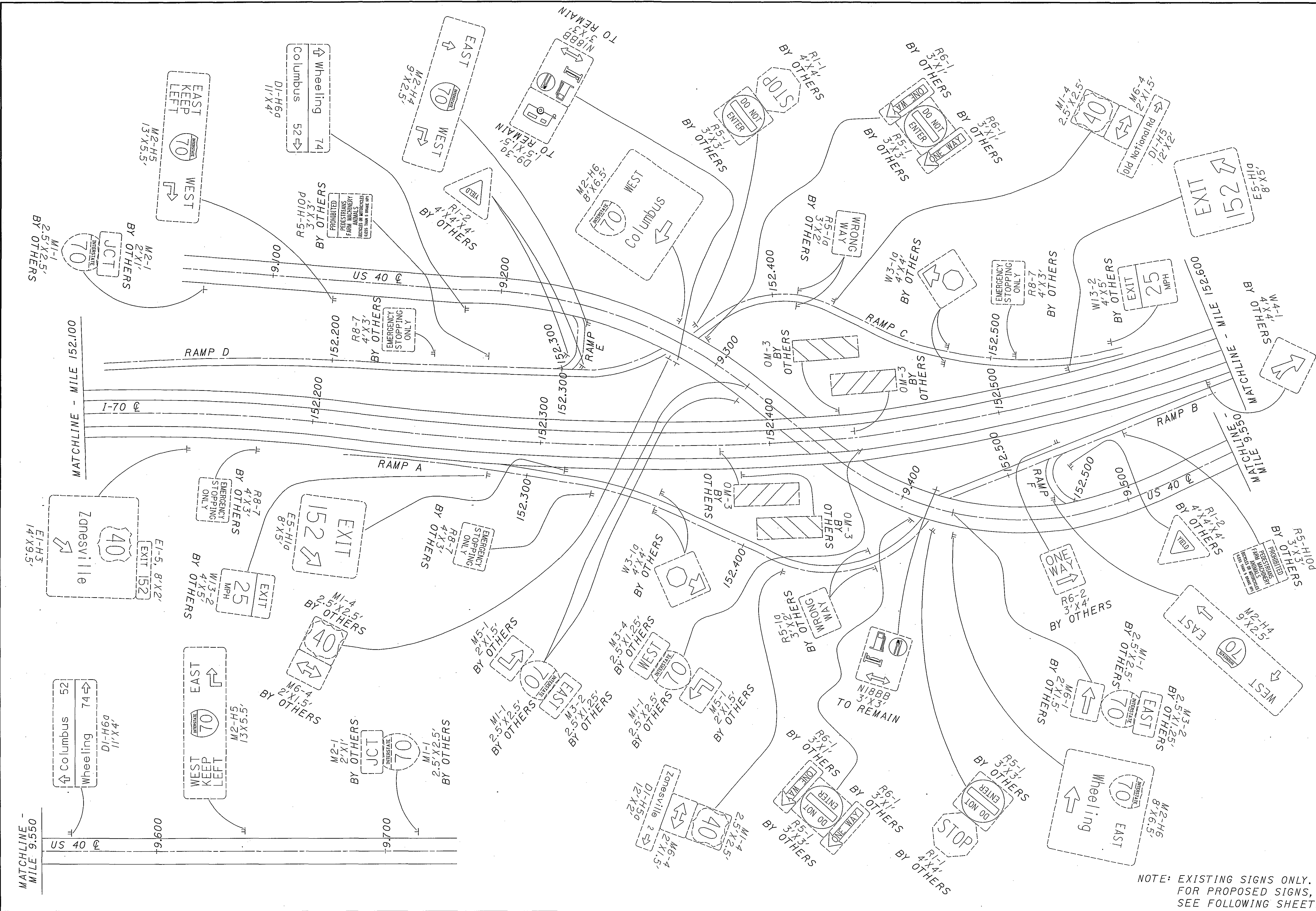

NOTE: EXISTING SIGNS ONLY.
FOR PROPOSED SIGNS,
SEE FOLLOWING SHEET.

SCALE IN FEET
HORIZONTAL
0 50 100 200

CALCULATED	JAM
CHECKED	WEB

MUSKINGUM COUNTY US 40 INTERCHANGE

D05 - SIGN - FY 2005

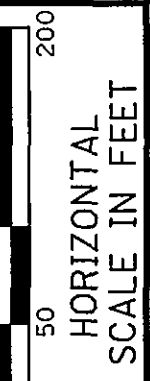

CALCULATED JAM CHECKED WEB

MUSKINGUM COUNTY
US 40 INTERCHANGE

D05 - SIGN - FY 2005

65
166

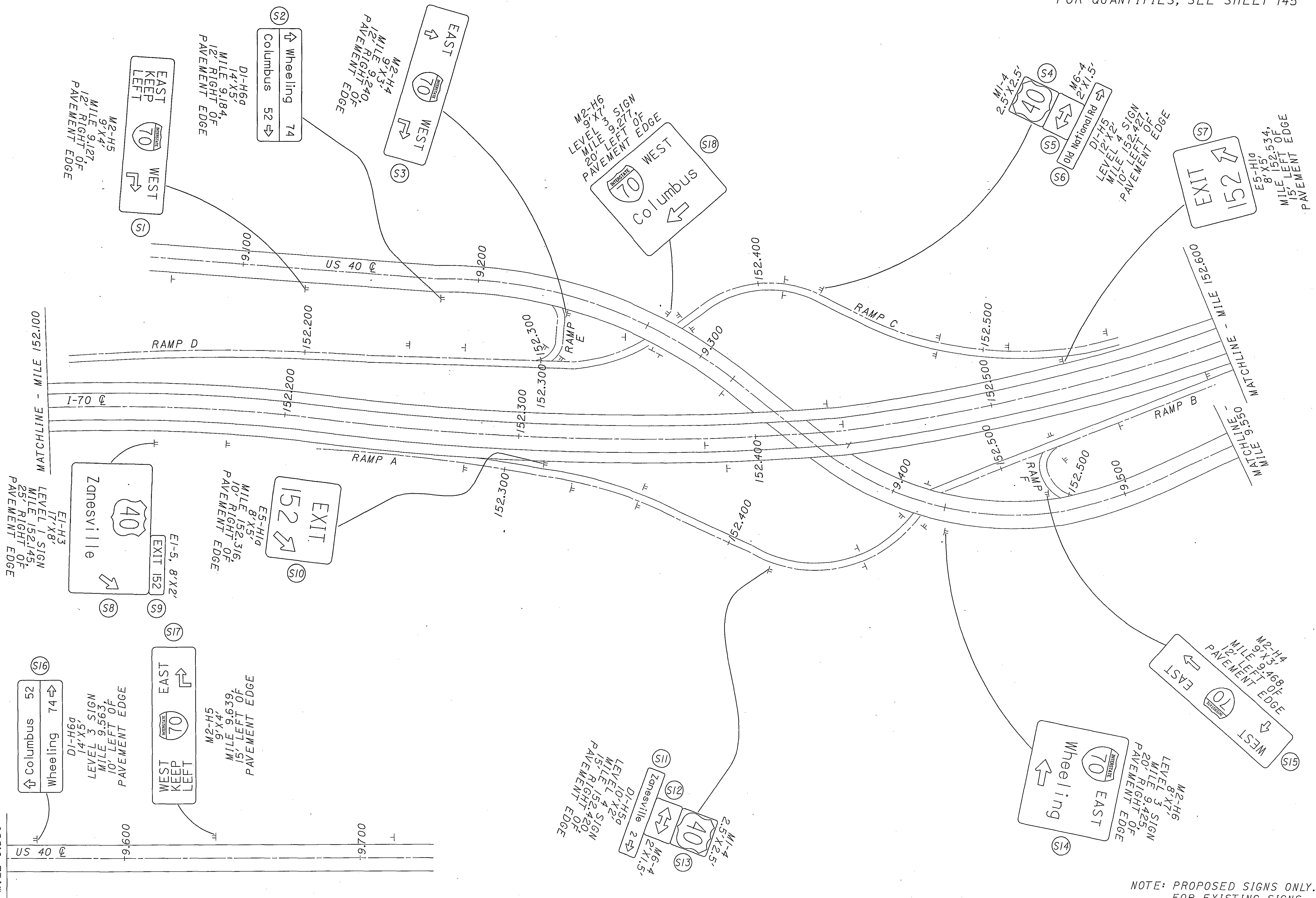

NOTE: PROPOSED SIGNS ONLY.
FOR EXISTING SIGNS,
SEE PREVIOUS SHEET.

08/13/2004 03:44:24 PM
m:\p06\022\1505\22 sign inventory\project plans\plansheets\tp0601to.dgn

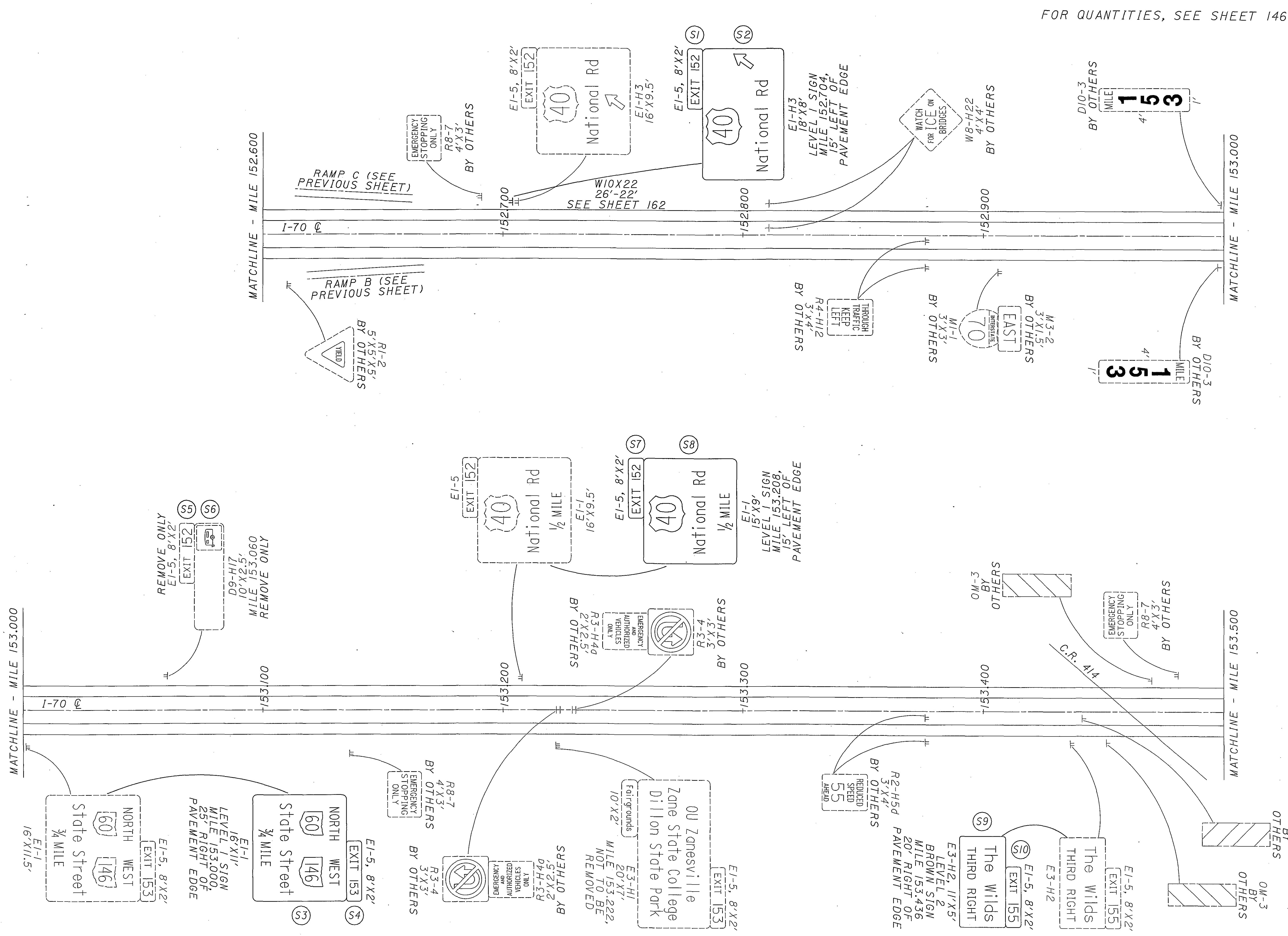

FOR QUANTITIES, SEE SHEET 146



MUSKINGUM COUNTY
MILE 152.600 TO MILE 153.500

D05-SIGN-FY2005

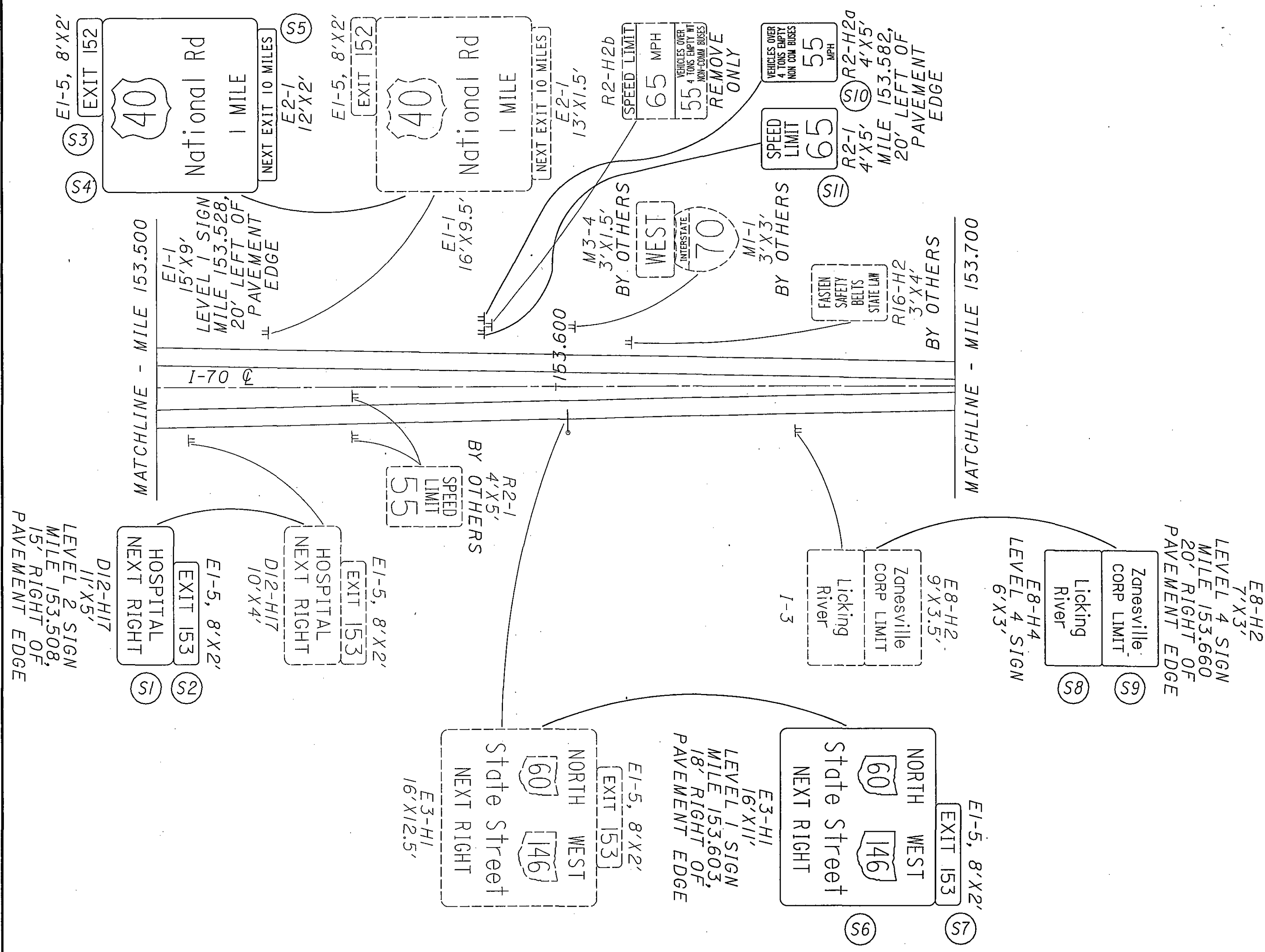

FOR QUANTITIES, SEE SHEET 146

CALCULATED
 JAM
 CHECKED
 WEB

0 100 200
 HORIZONTAL
 SCALE IN FEET

▲
 N

MUSKINGUM COUNTY
 MILE 153.500 TO MILE 153.700

D05 - SIGN - FY 2005

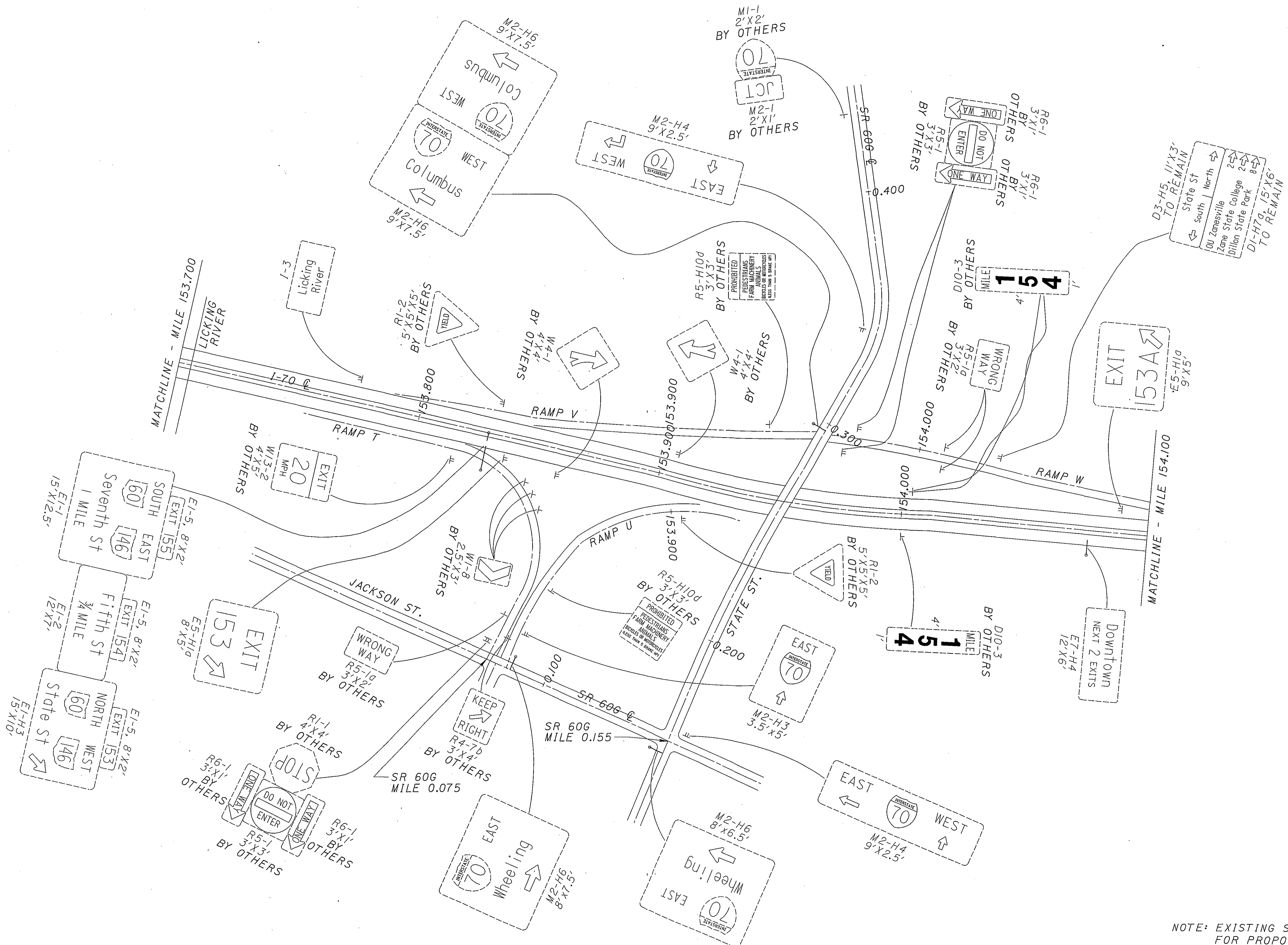

NOTE: EXISTING SIGNS ONLY.
FOR PROPOSED SIGNS,
SEE FOLLOWING SHEET.

0 100 200
HORIZONTAL SCALE IN FEET

CALCULATED JAN
CHECKED WEB

MUSKINGUM COUNTY
SR 60G INTERCHANGE

D05 - SIGN - FY 2005

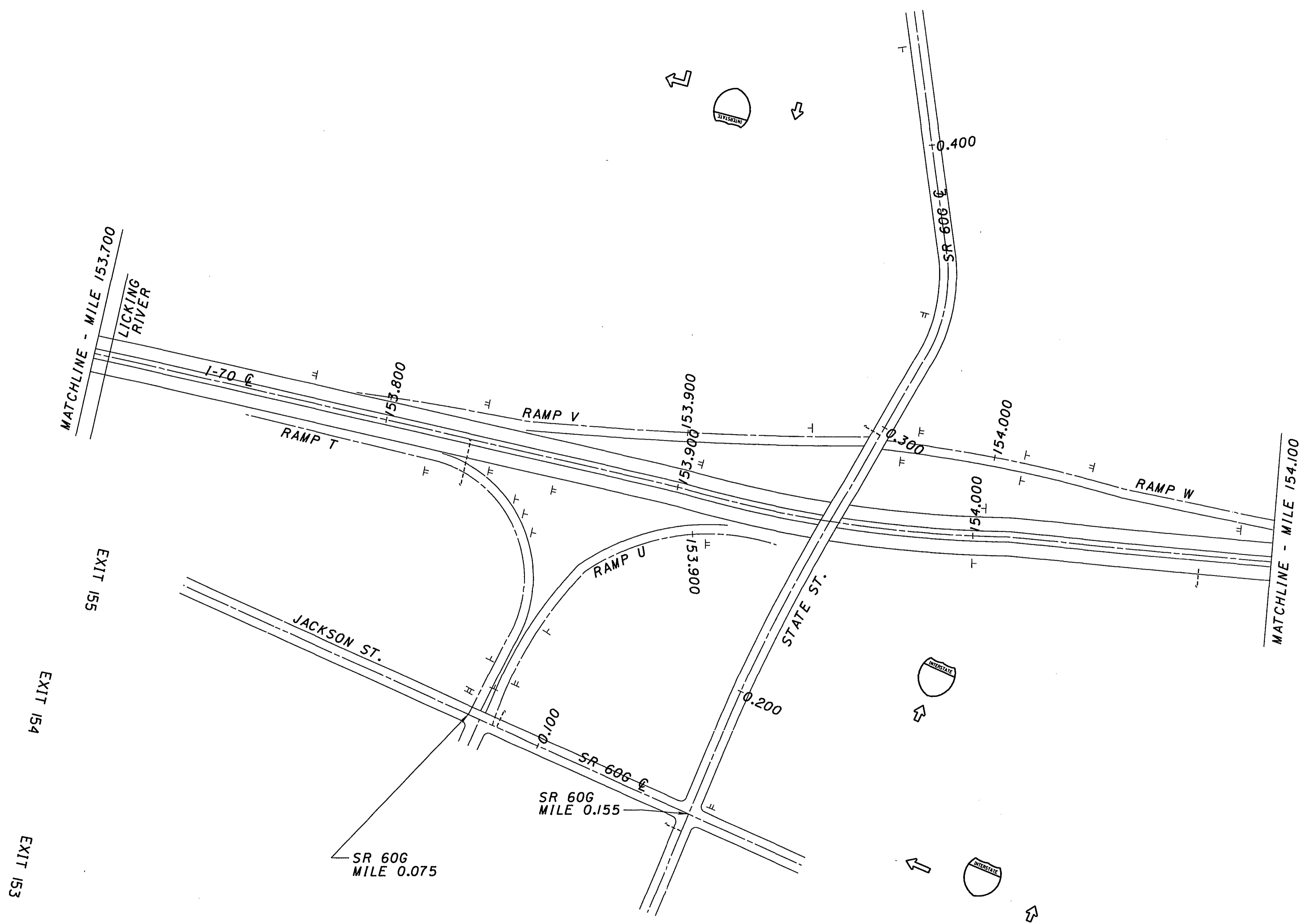

CALCULATED JAM
 CHECKED WEB

0 100 200
 HORIZONTAL SCALE IN FEET

MUSKINGUM COUNTY
 SR 60G INTERCHANGE

D05 - SIGN - FY 2005

69
 66

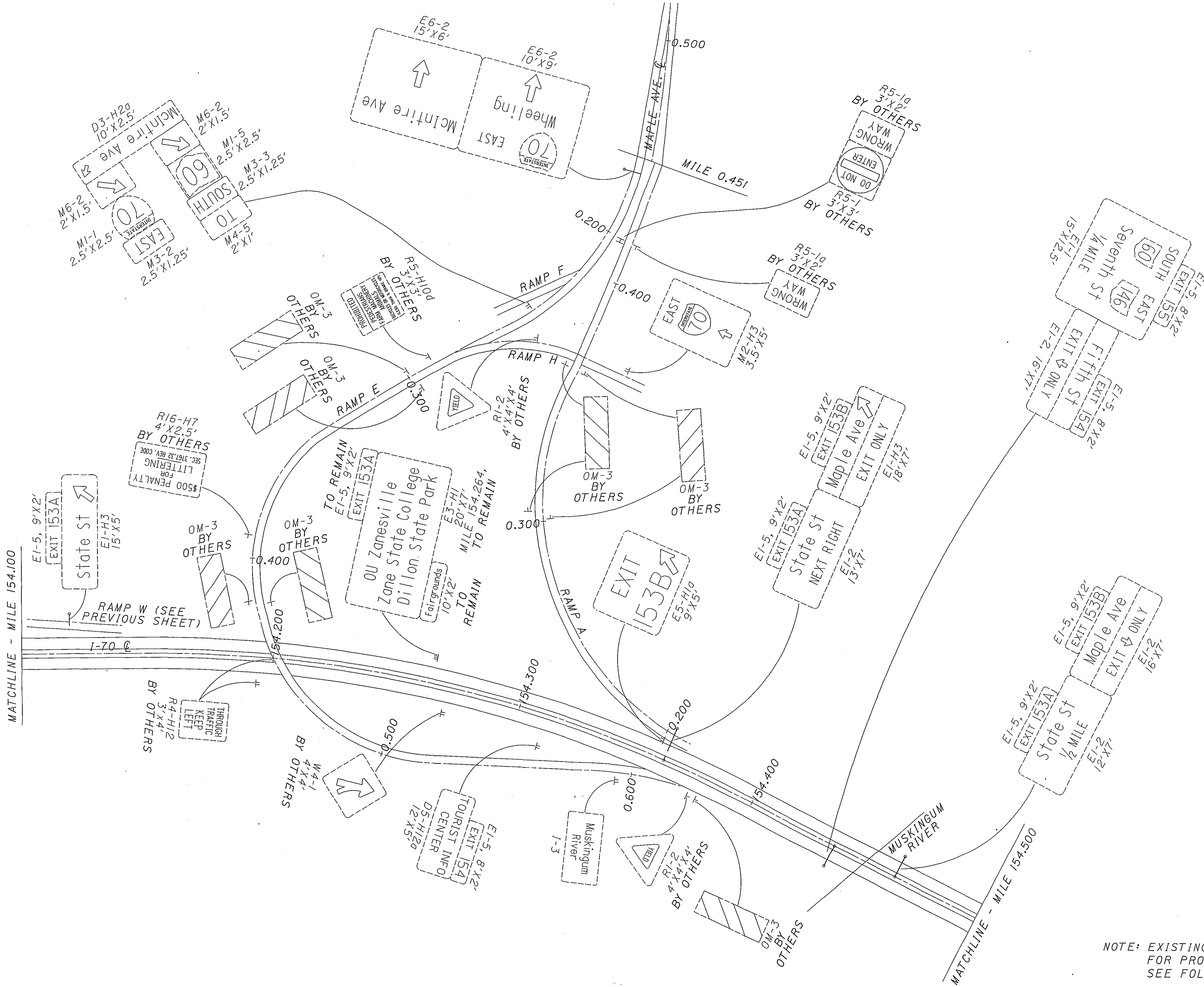

NOTE: EXISTING SIGNS ONLY.
 FOR PROPOSED SIGNS,
 SEE FOLLOWING SHEET.

MUSKINGUM COUNTY
 MAPLE AVENUE INTERCHANGE

D05 - SIGN - FY 2005

CALCULATED JAM CHECKED WEB
 0 100 200
 HORIZONTAL SCALE IN FEET

70
 166

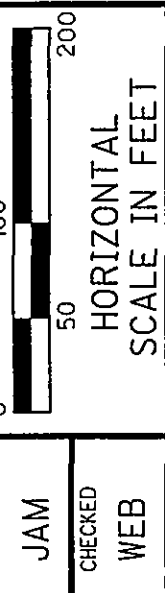

MUSKINGUM COUNTY
MAPLE AVENUE INTERCHANGE

D05 - SIGN - FY 2005

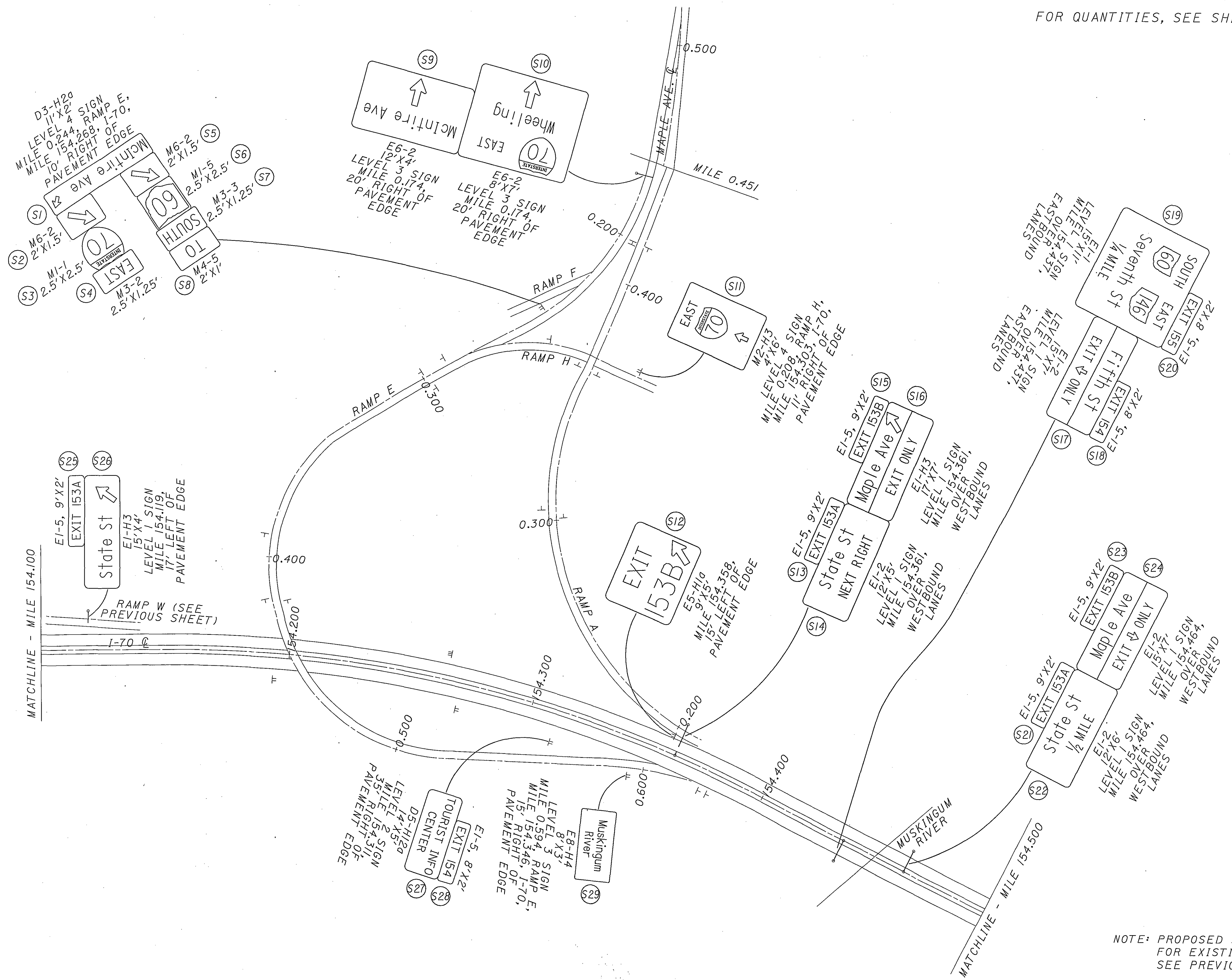

NOTE: PROPOSED SIGNS ONLY.
FOR EXISTING SIGNS,
SEE PREVIOUS SHEET.

08/13/2004
03:54:26 PM
m:\proj\022\1505\22 sign inventory\project plans\plansheets\tp066170.dgn

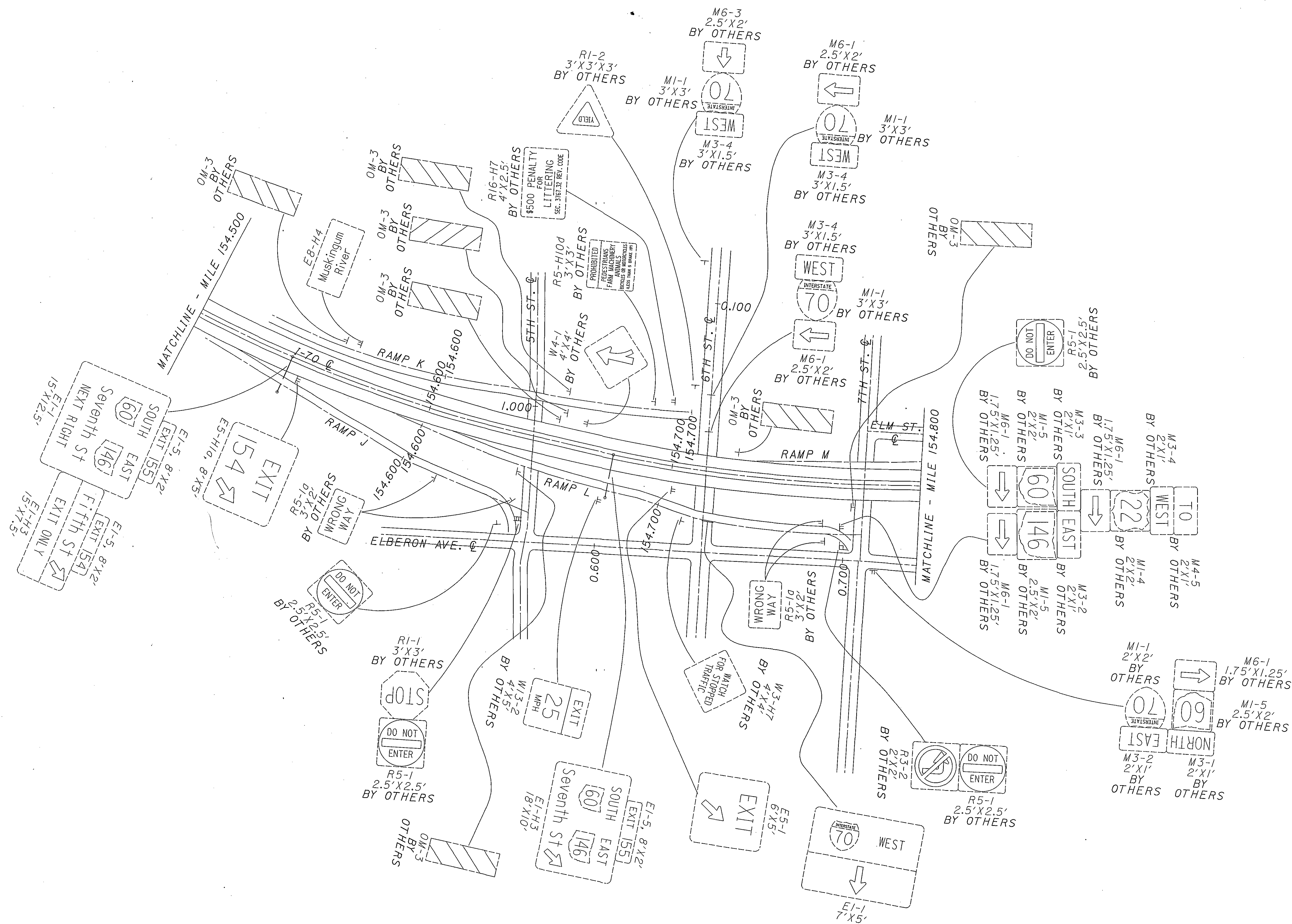

NOTE: EXISTING SIGNS ONLY. FOR PROPOSED SIGNS, SEE FOLLOWING SHEET.

CALCULATED
JAM
CHECKED
WEB

HORIZONTAL SCALE IN FEET
0 50 100 200

MUSKINGUM COUNTY
5TH, 6TH, & 7TH STREET INTERCHANGES

D05 - SIGN - FY2005

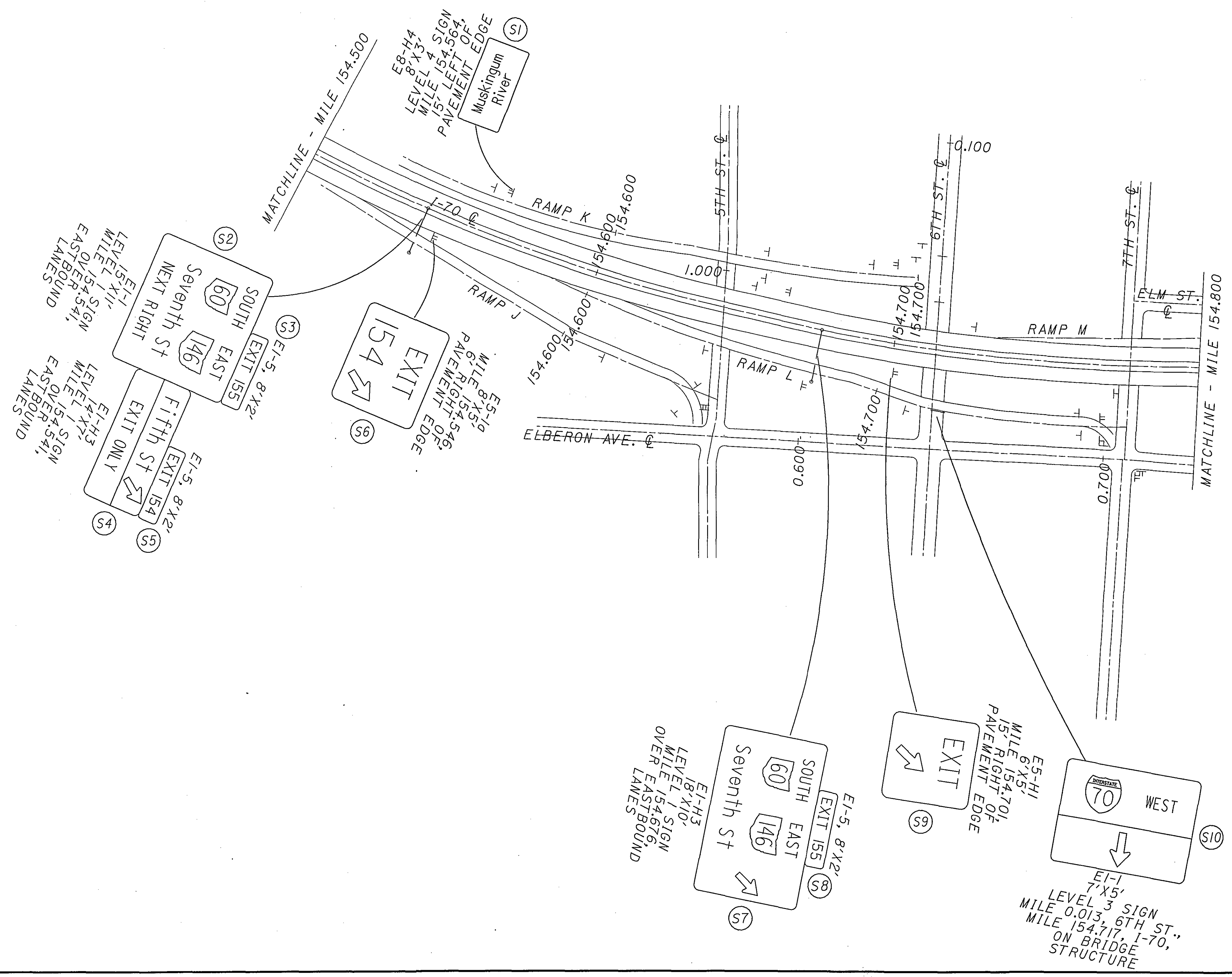

NOTE: PROPOSED SIGNS ONLY.
FOR EXISTING SIGNS,
SEE PREVIOUS SHEET.

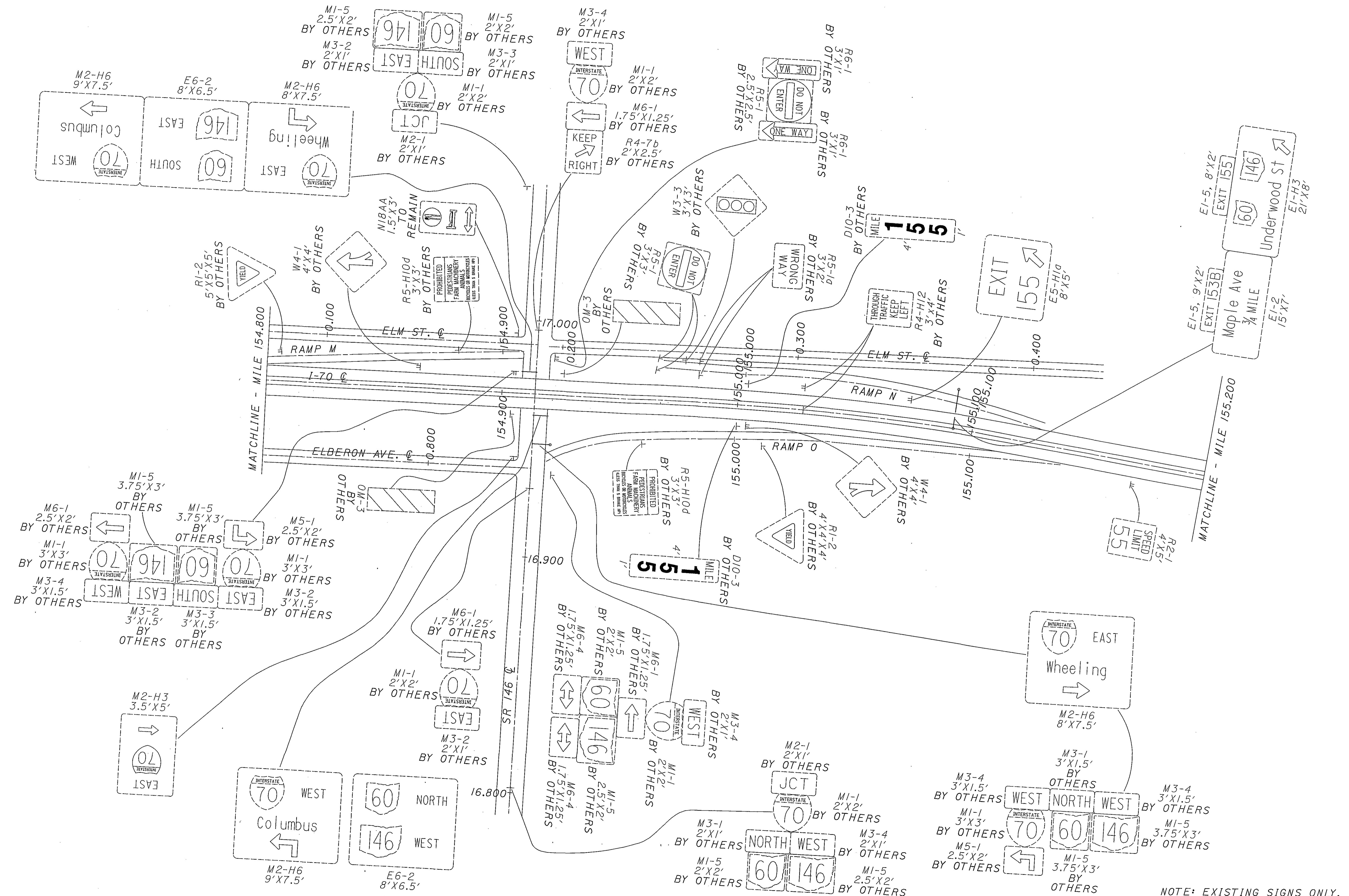

NOTE: EXISTING SIGNS ONLY. FOR PROPOSED SIGNS, SEE FOLLOWING SHEET.

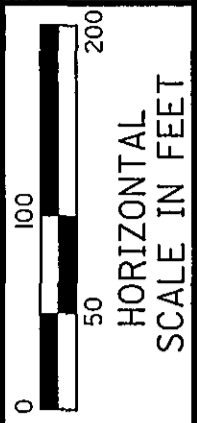

CALCULATED	JAM	CHECKED	WEB
------------	-----	---------	-----

MUSKINGUM COUNTY
SR 146 INTERCHANGE

D05 - SIGN - FY 2005

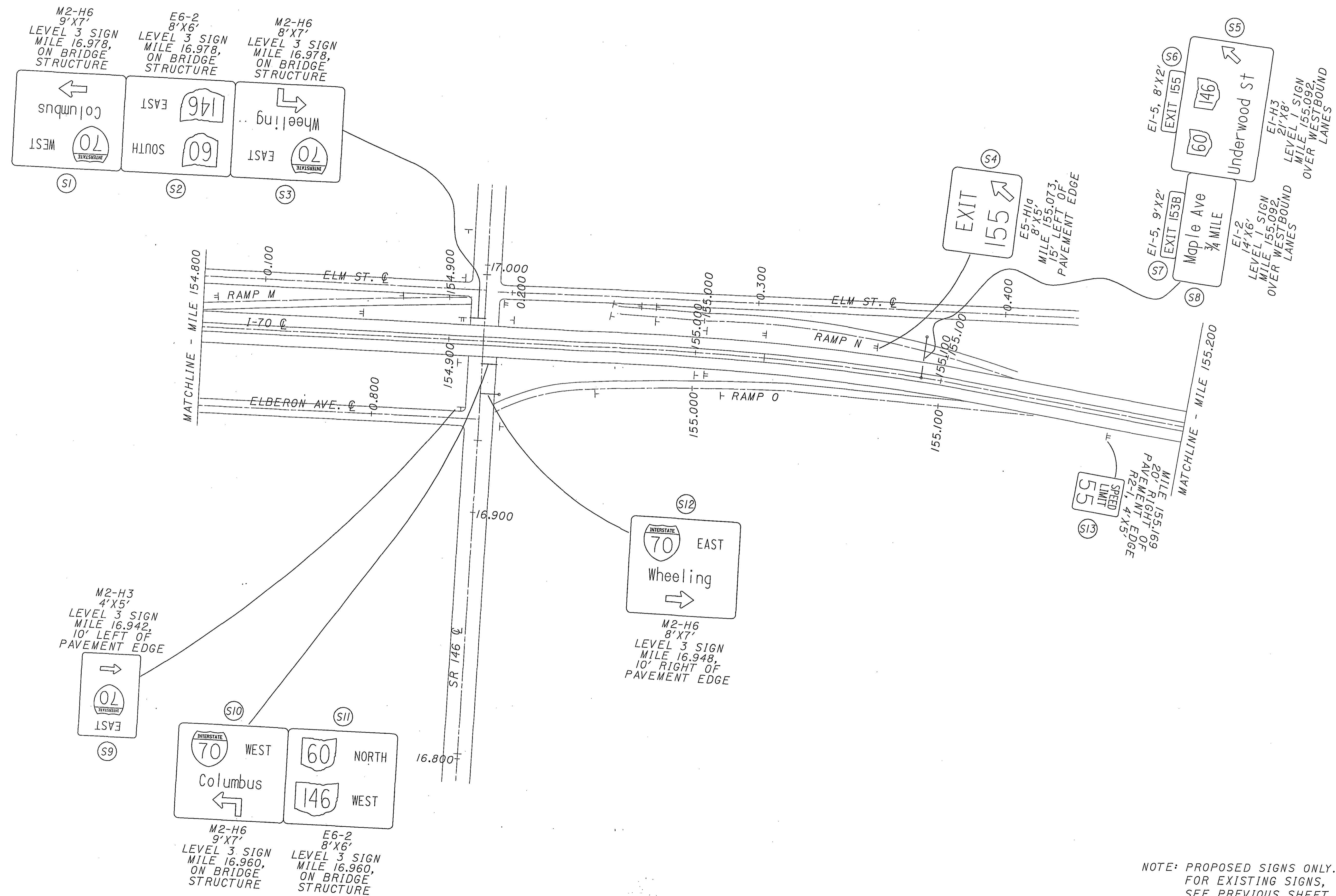

NOTE: PROPOSED SIGNS ONLY.
FOR EXISTING SIGNS,
SEE PREVIOUS SHEET.

08/13/2004 03:54:27 PM m:\p\proj\0221\05\22 sign inventory\project plans\plansheets\tp0701070.dgn

MATCHLINE - MILE 155.500

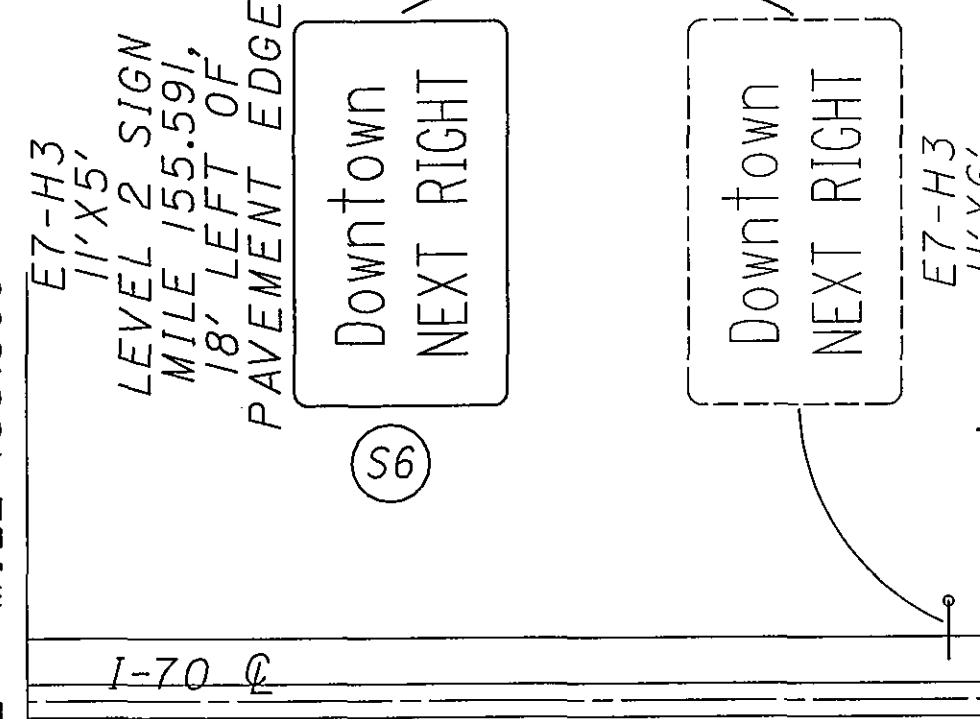

155.600

155.700

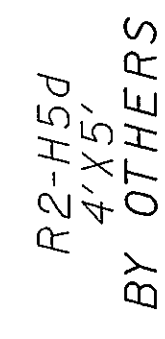

155.800

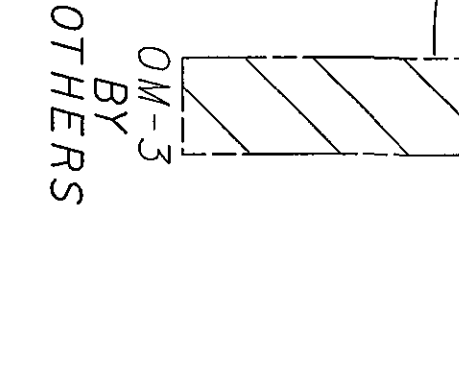

155.900

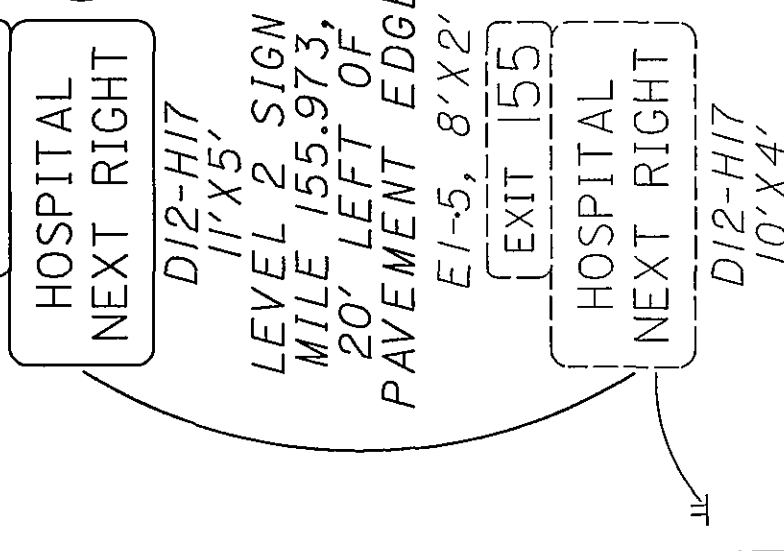

MATCHLINE - MILE 156.000

MATCHLINE - MILE 155.200



155.300

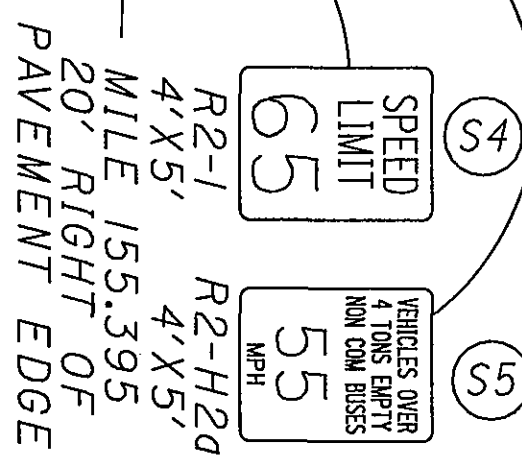
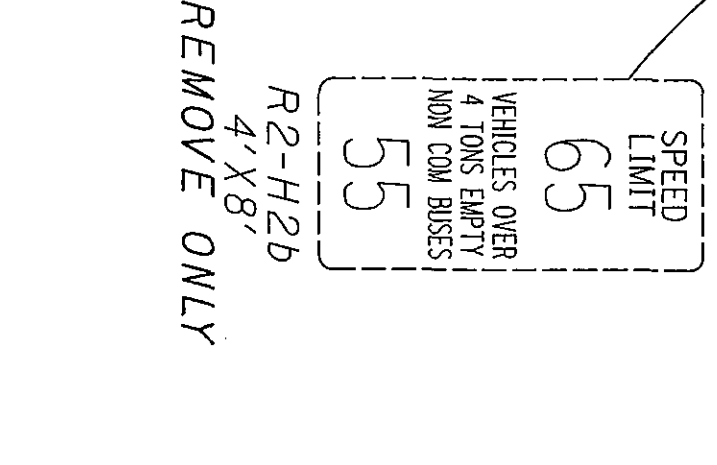

155.400

SIGN ATTACHED TO LIGHT POLE

HAMLIN AVE.

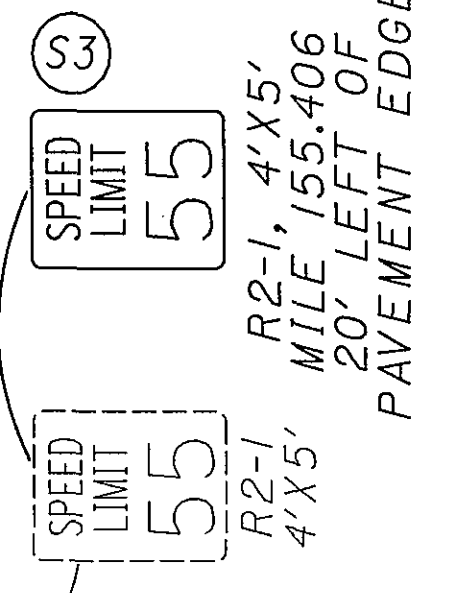

MATCHLINE - MILE 155.500

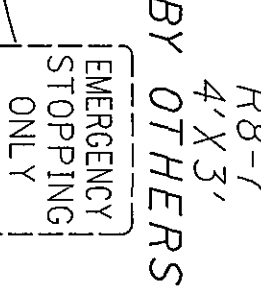

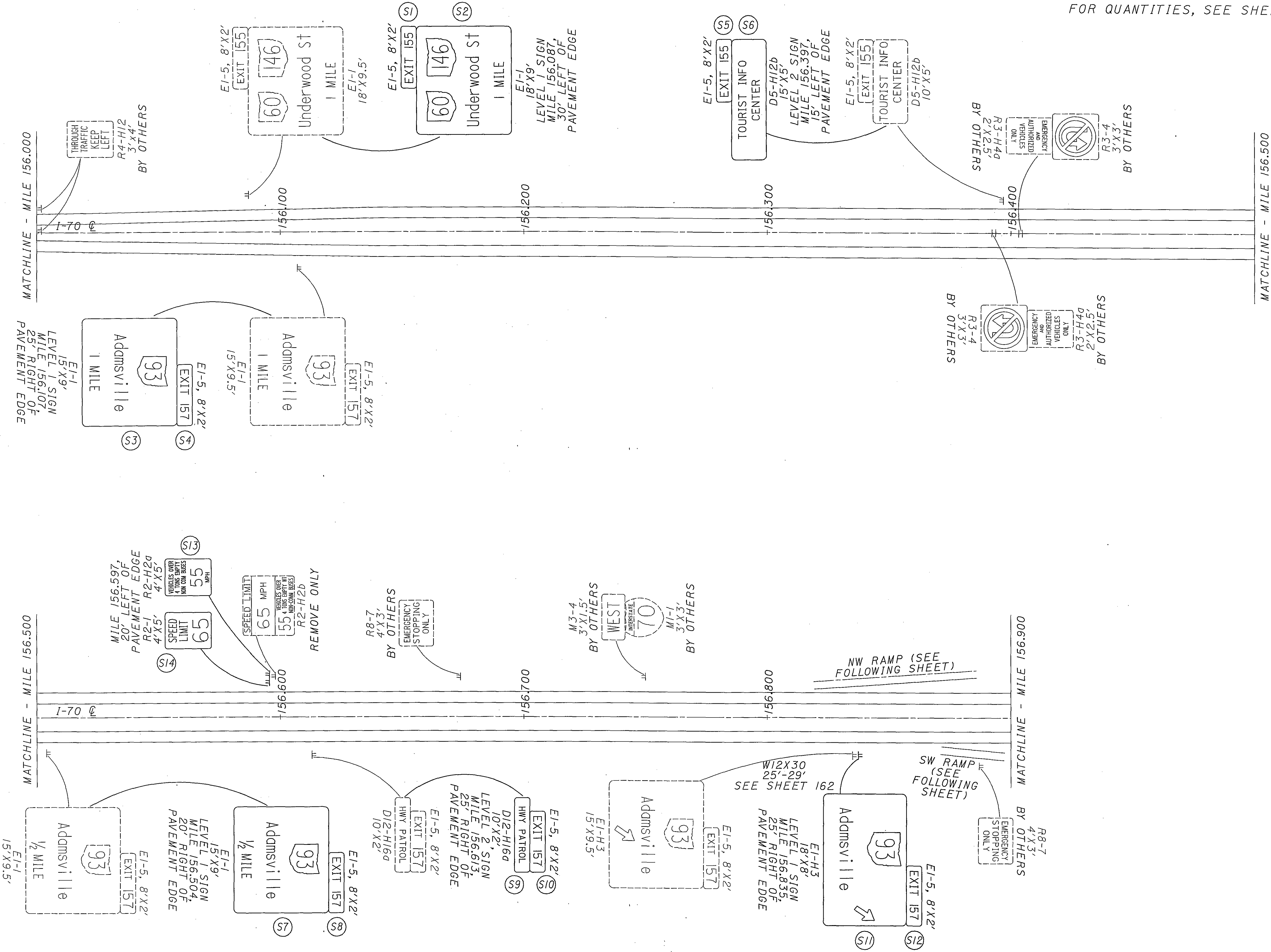

CALCULATED JAM CHECKED WEB

0 100 200

HORIZONTAL SCALE IN FEET

↑

MUSKINGUM COUNTY

MILE 156.000 TO MILE 156.900

D05-SIGN-FY2005

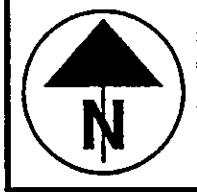

0 100 200
HORIZONTAL
SCALE IN FEET

CALCULATED
DAP
CHECKED
WEB

MUSKINGUM COUNTY
SR 93 INTERCHANGE

D05 - SIGN - FY 2005

79
166

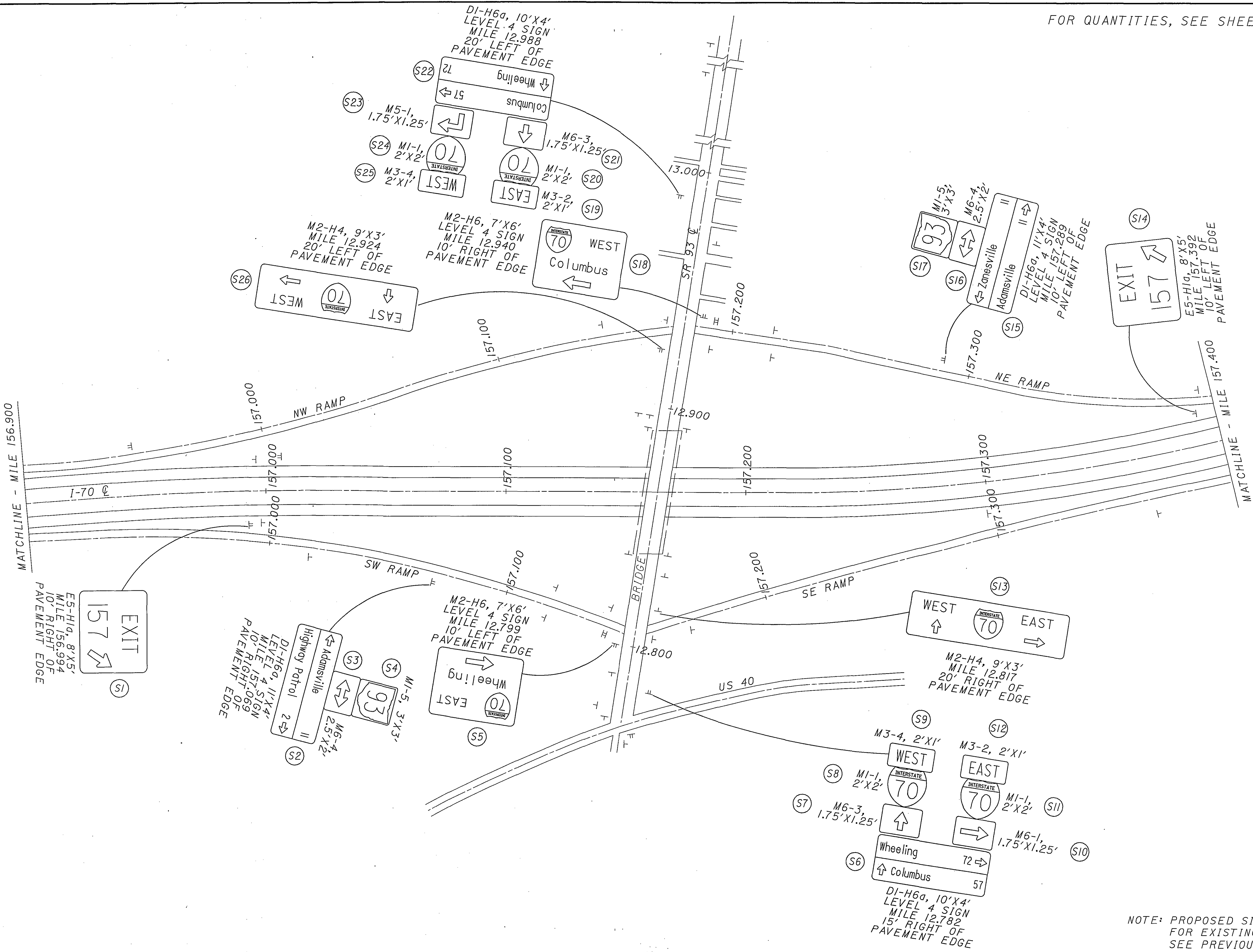

NOTE: PROPOSED SIGNS ONLY.
FOR EXISTING SIGNS,
SEE PREVIOUS SHEET.

MATCHLINE - MILE 158.000

MATCHLINE - MILE 158.500

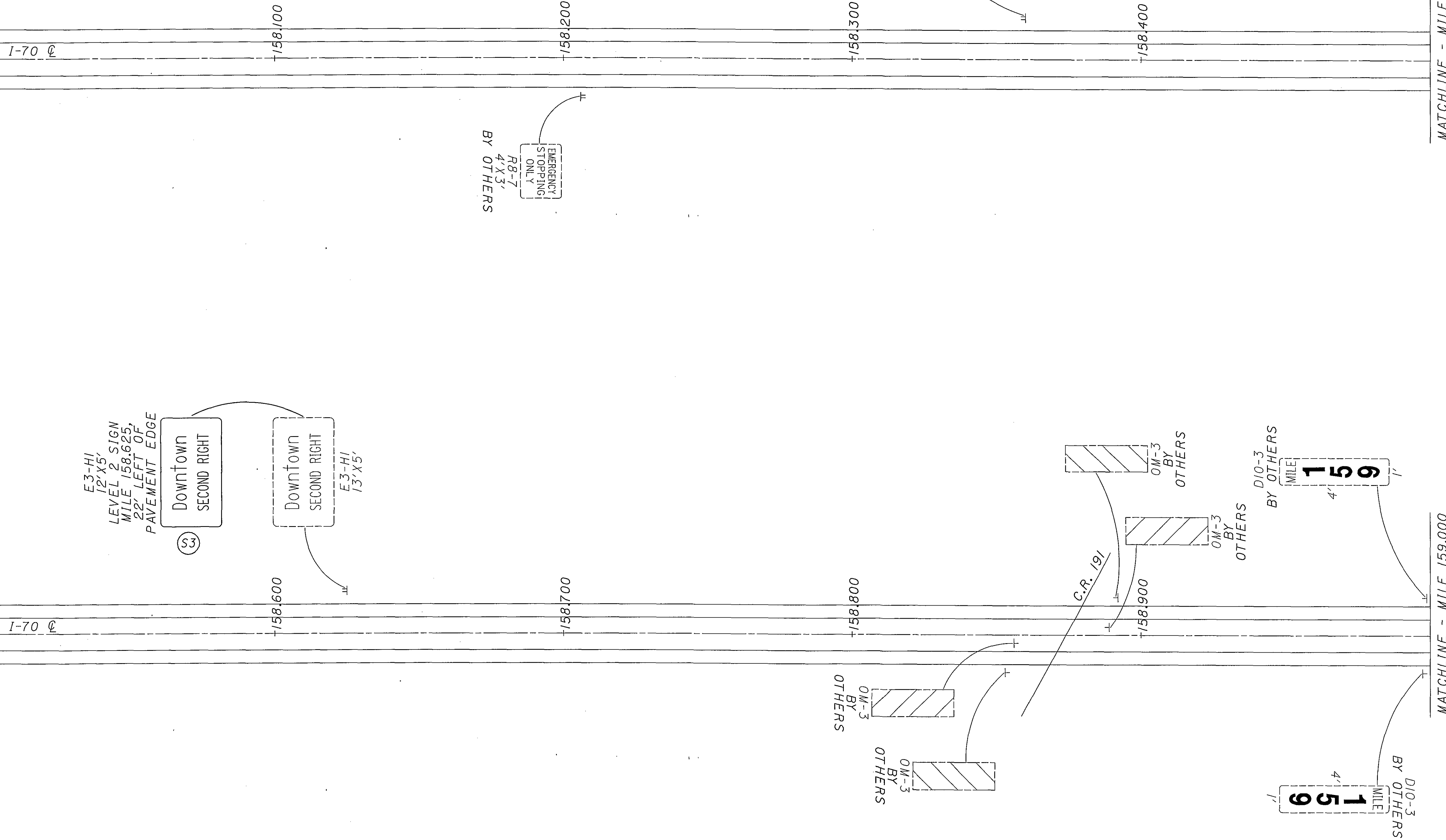

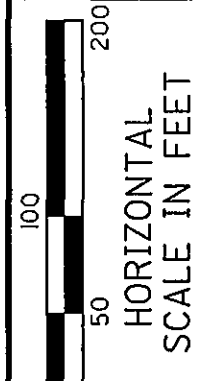
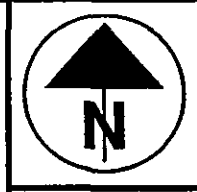

CALCULATED
JAM
CHECKED
WEB

MUSKINGUM COUNTY
MILE 159.000 TO MILE 160.000

D05 - SIGN - FY 2005

MATCHLINE - MILE 159.000

MATCHLINE - MILE 159.500

MATCHLINE - MILE 159.500

MATCHLINE - MILE 160.000

I-70

I-70

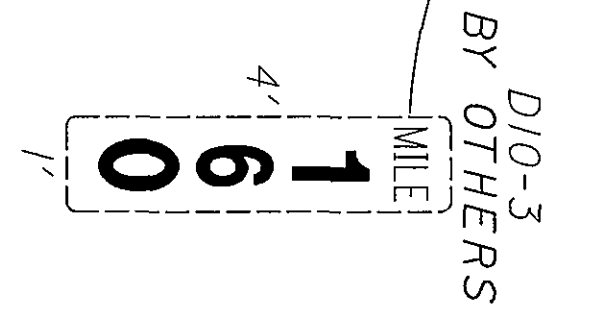
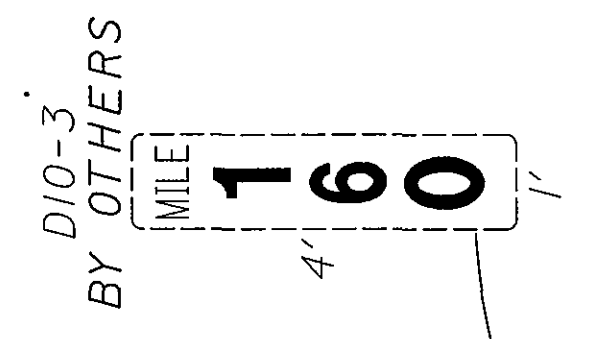
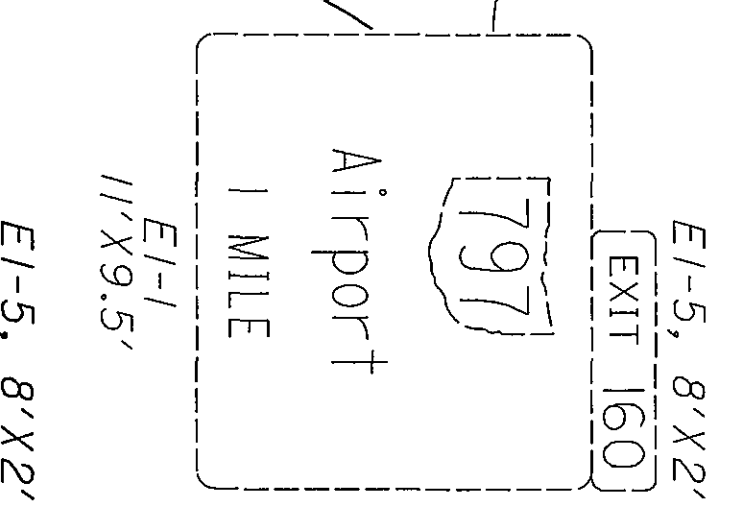
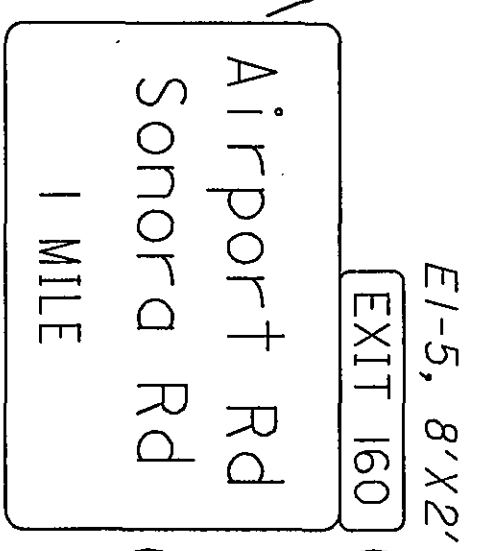
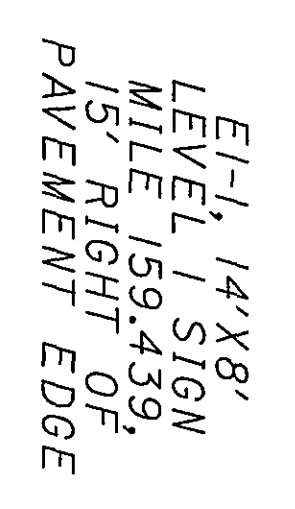
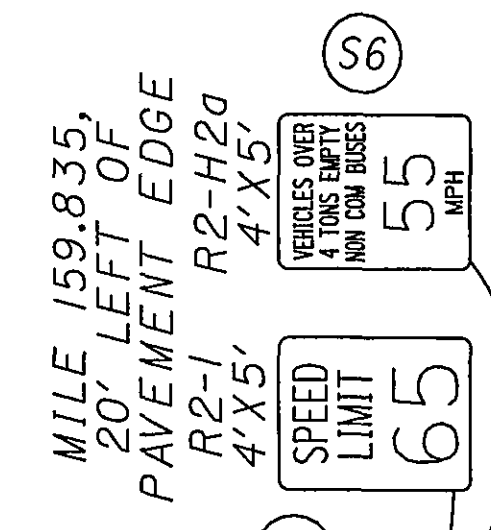
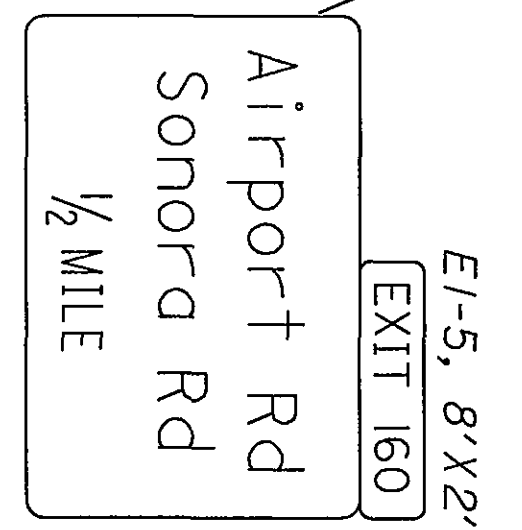
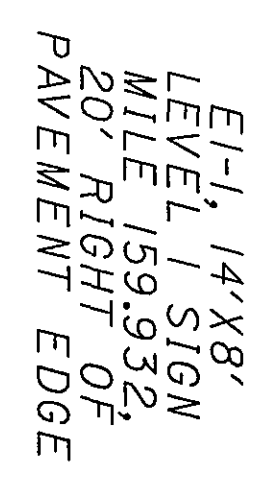
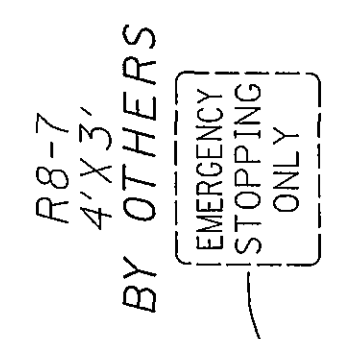
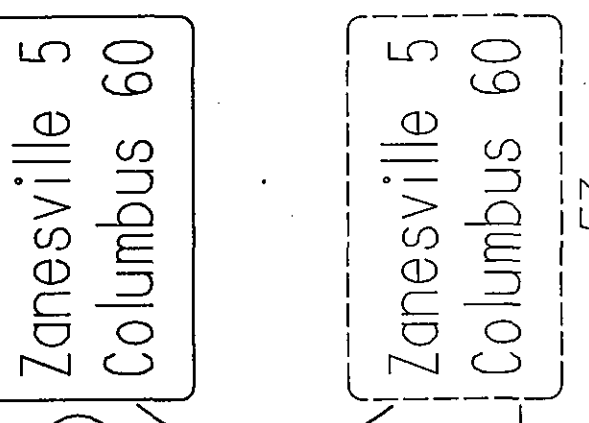
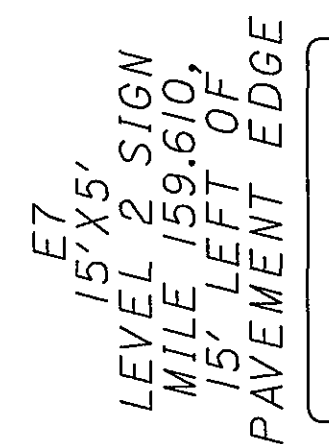
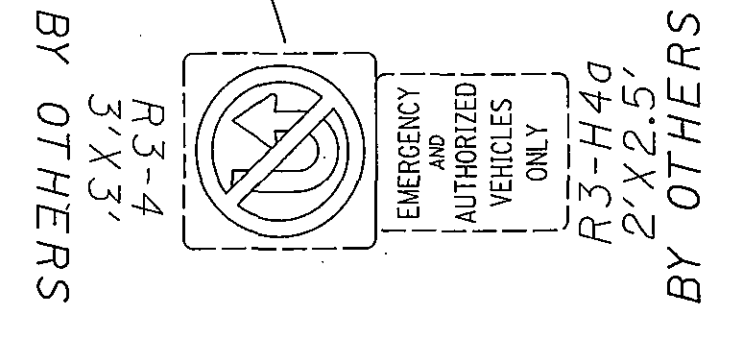
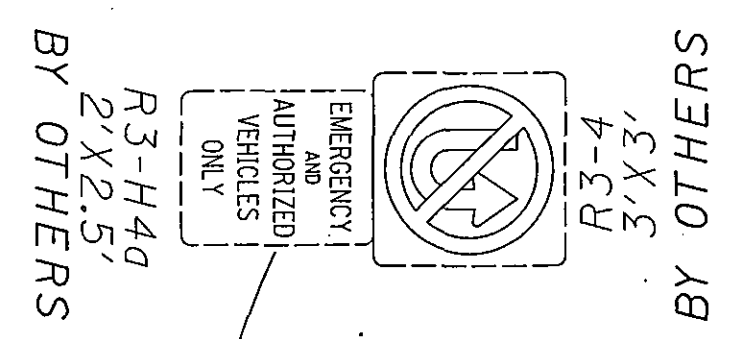

MATCHLINE - MILE 160.000

I-70

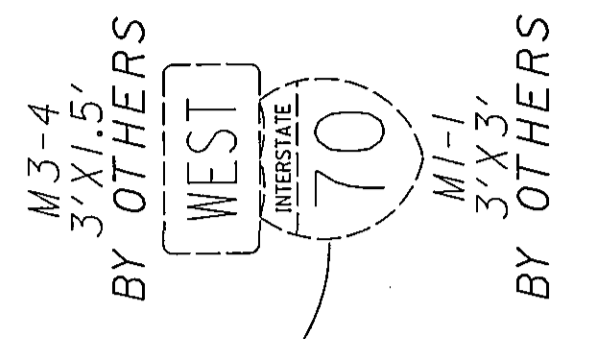

160.100

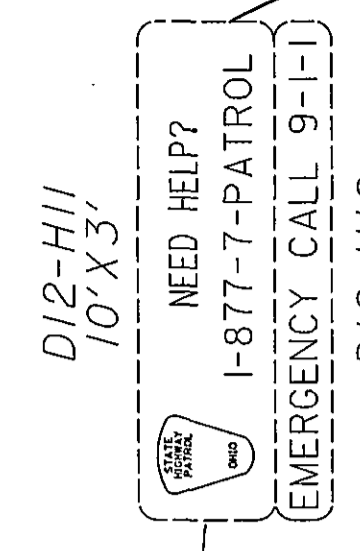

D12-H11
10' X 3'

E1-H3, 17' X 6'
LEVEL 1 SIGN
MILE 160.289,
30' RIGHT OF
PAVEMENT EDGE

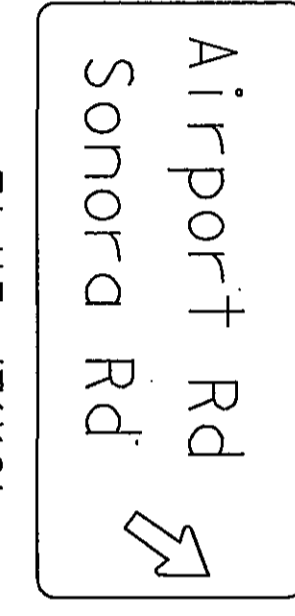

(S3)

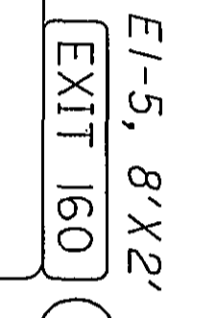

(S4)

W10X22
23'-19'
SEE SHEET 162

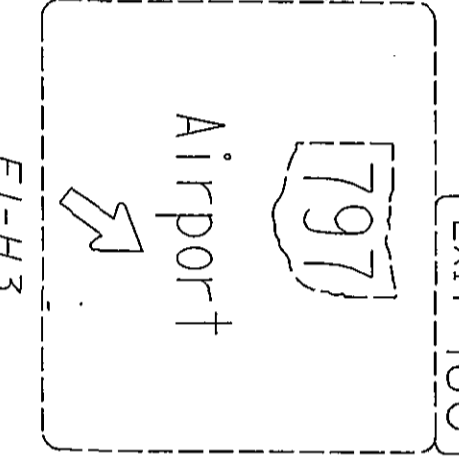

E1-H3
11' X 9.5'

160.200

D12-H11
10' X 3'
MILE 160.141,
15' LEFT OF
PAVEMENT EDGE

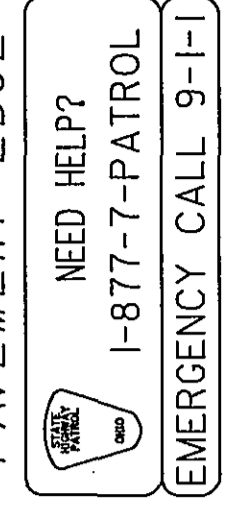

(S1)

(S2)

160.300

NW RAMP (SEE FOLLOWING SHEET)

R8-7
4' X 3'
BY OTHERS



SW RAMP (SEE FOLLOWING SHEET)

MATCHLINE - MILE 160.400

CALCULATED
 JAM
 CHECKED
 WEB

HORIZONTAL SCALE IN FEET

MUSKINGUM COUNTY
 MILE 160.000 TO MILE 160.400

D05 - SIGN - FY 2005

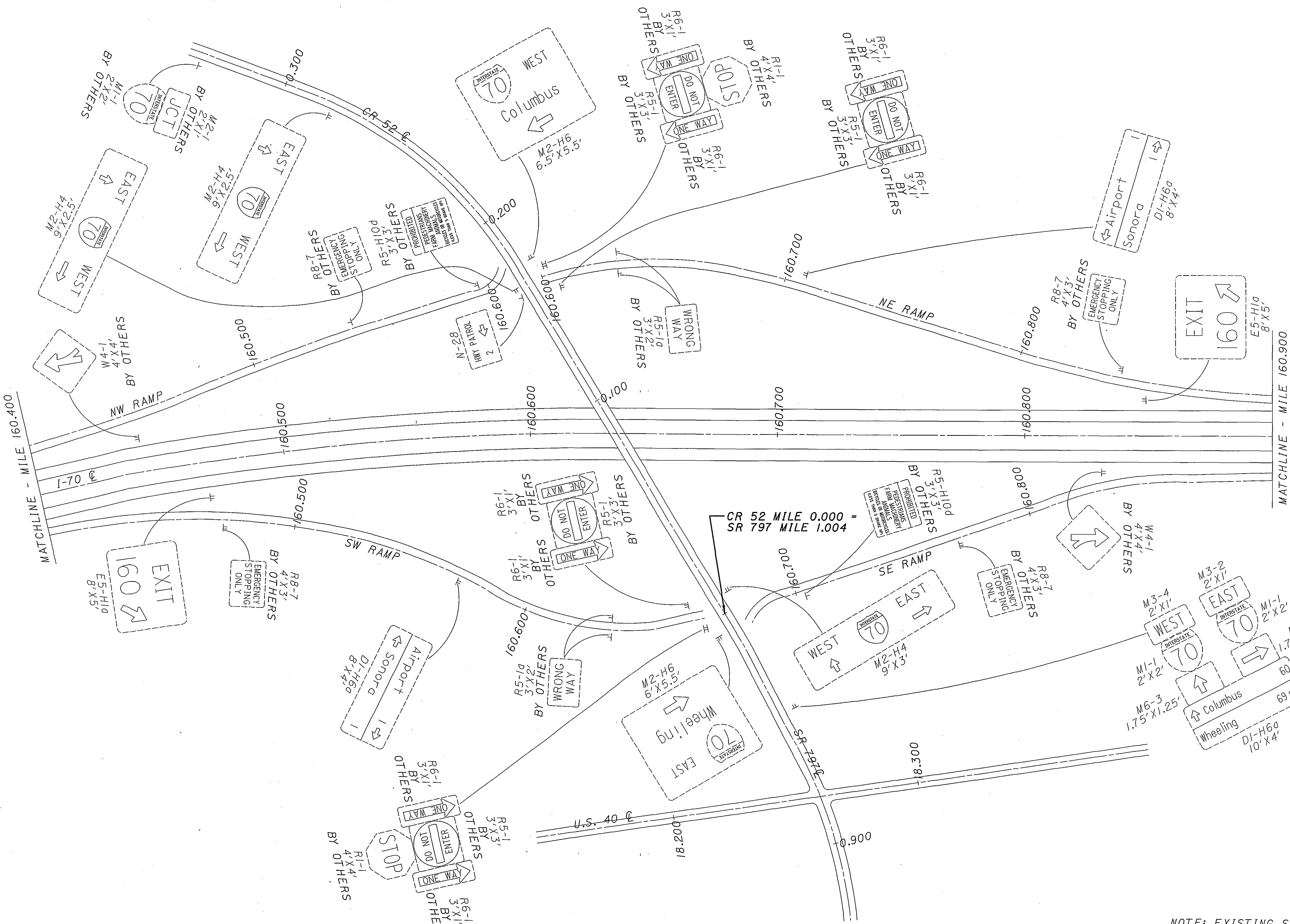

NOTE: EXISTING SIGNS ONLY.
 FOR PROPOSED SIGNS,
 SEE FOLLOWING SHEET.

 0 100 200
 HORIZONTAL SCALE IN FEET
 CALCULATED JAM CHECKED WEB

**MUSKINGUM COUNTY
 CR 52 INTERCHANGE**

D05 - SIGN - FY 2005

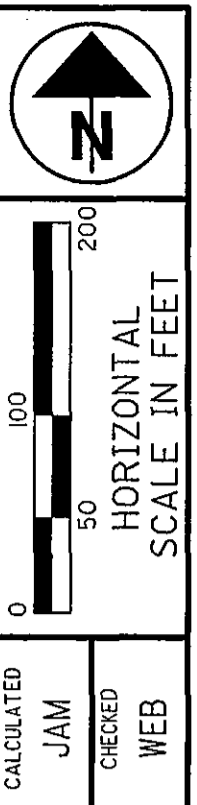

MUSKINGUM COUNTY
CR 52 & SR 797 INTERCHANGE

D05 - SIGN - FY 2005

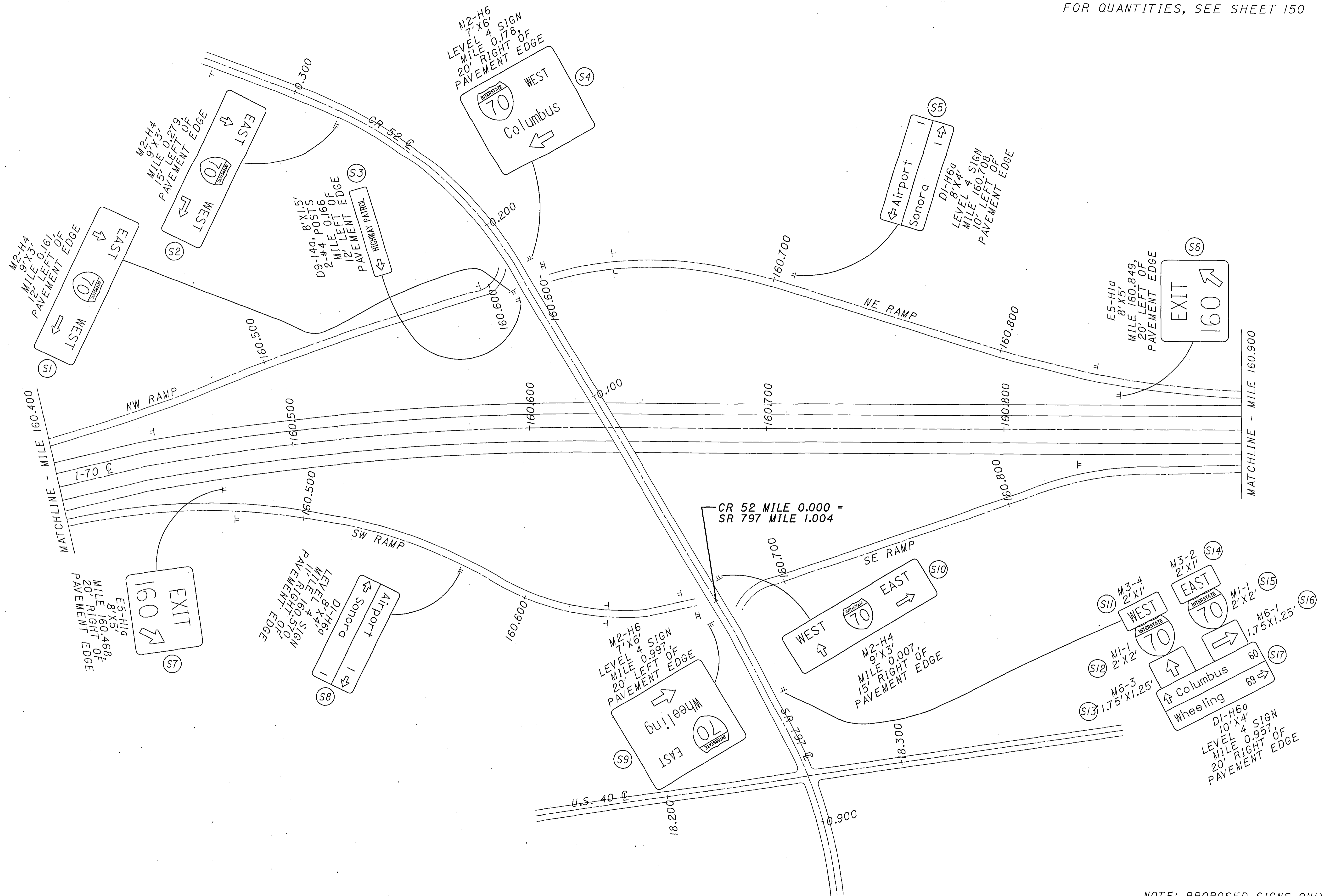

NOTE: PROPOSED SIGNS ONLY.
FOR EXISTING SIGNS,
SEE PREVIOUS SHEET.

08/13/2004 03:54:30 PM m:\p\01\022\1505\22 sign inventory\project plans\plansheets\150810.dgn

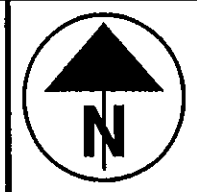

MUSKINGUM COUNTY
 MILE 160.900 TO MILE 161.500

D05 - SIGN - FY 2005

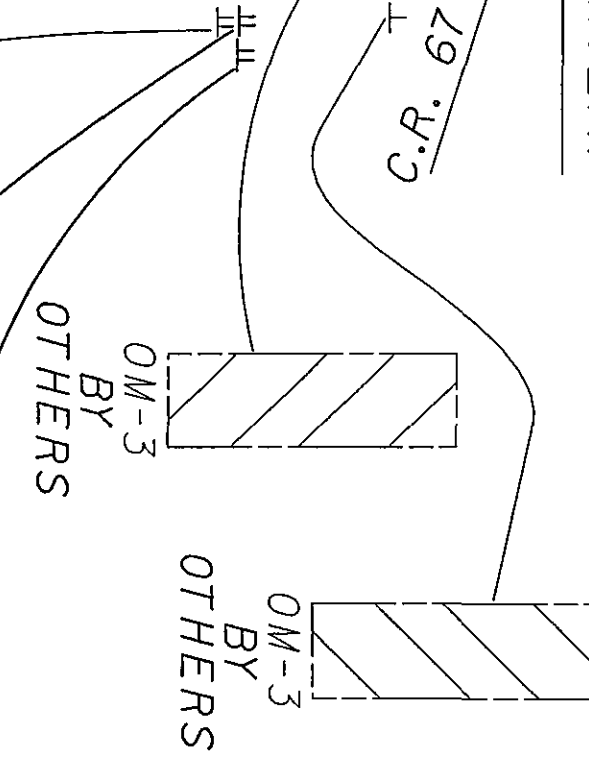
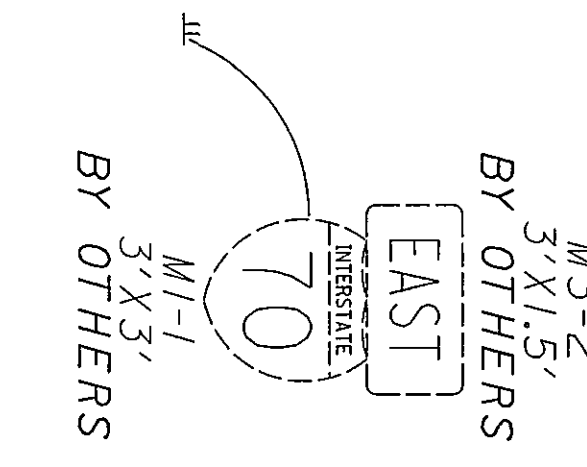
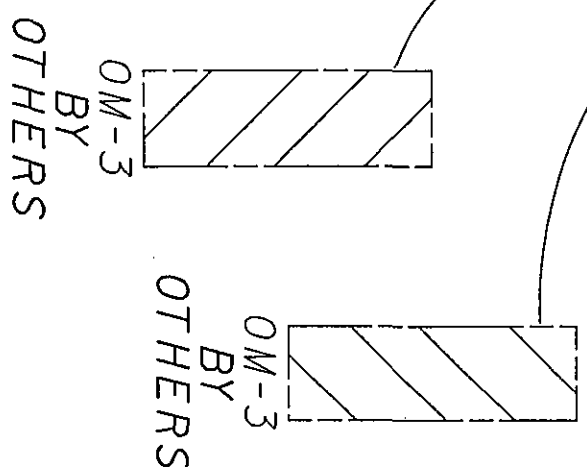
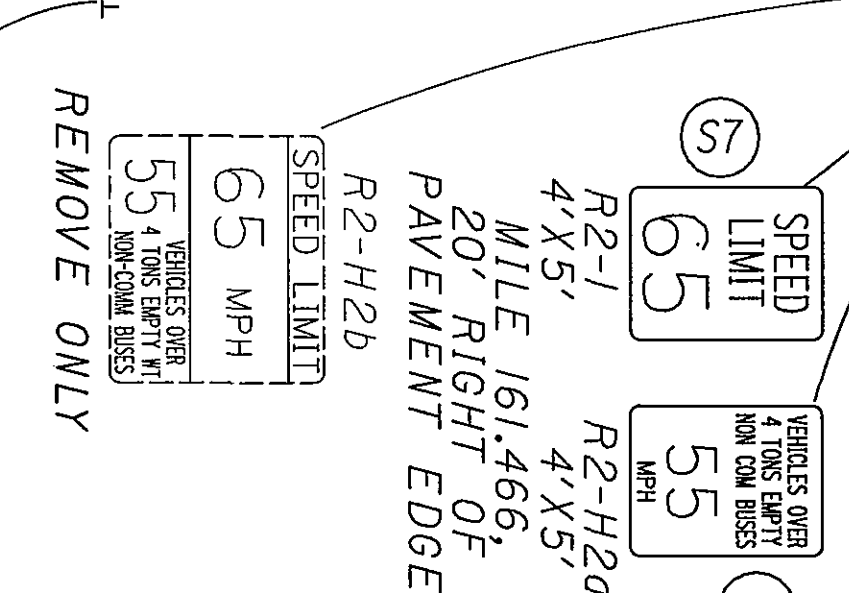
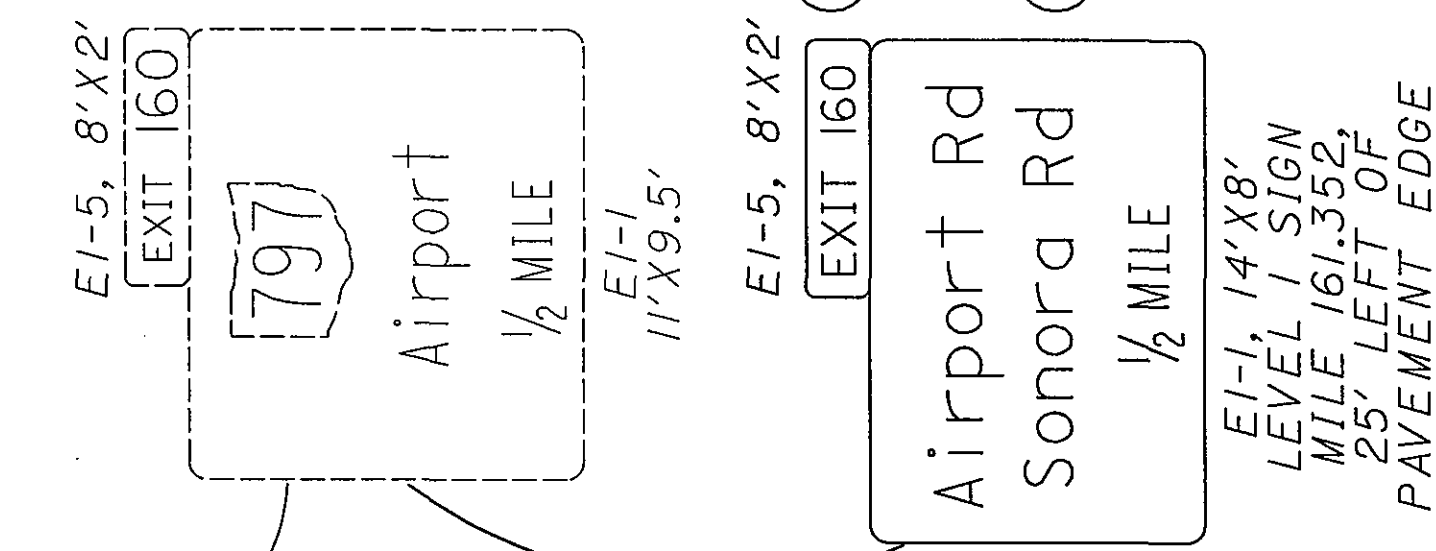
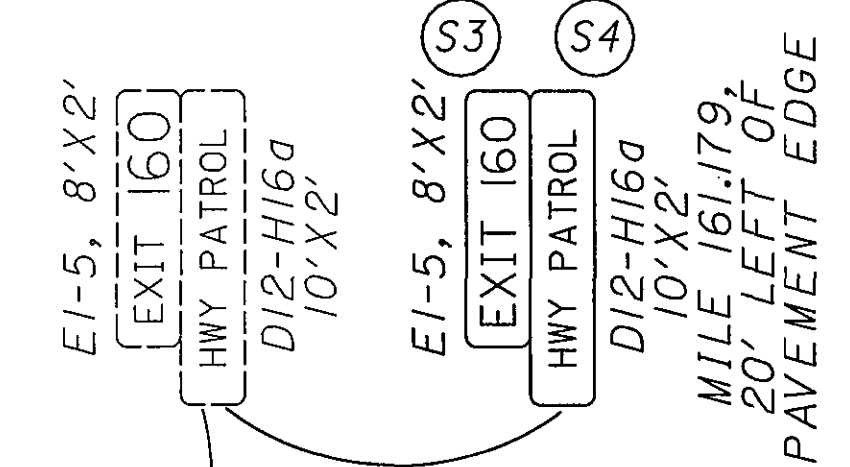
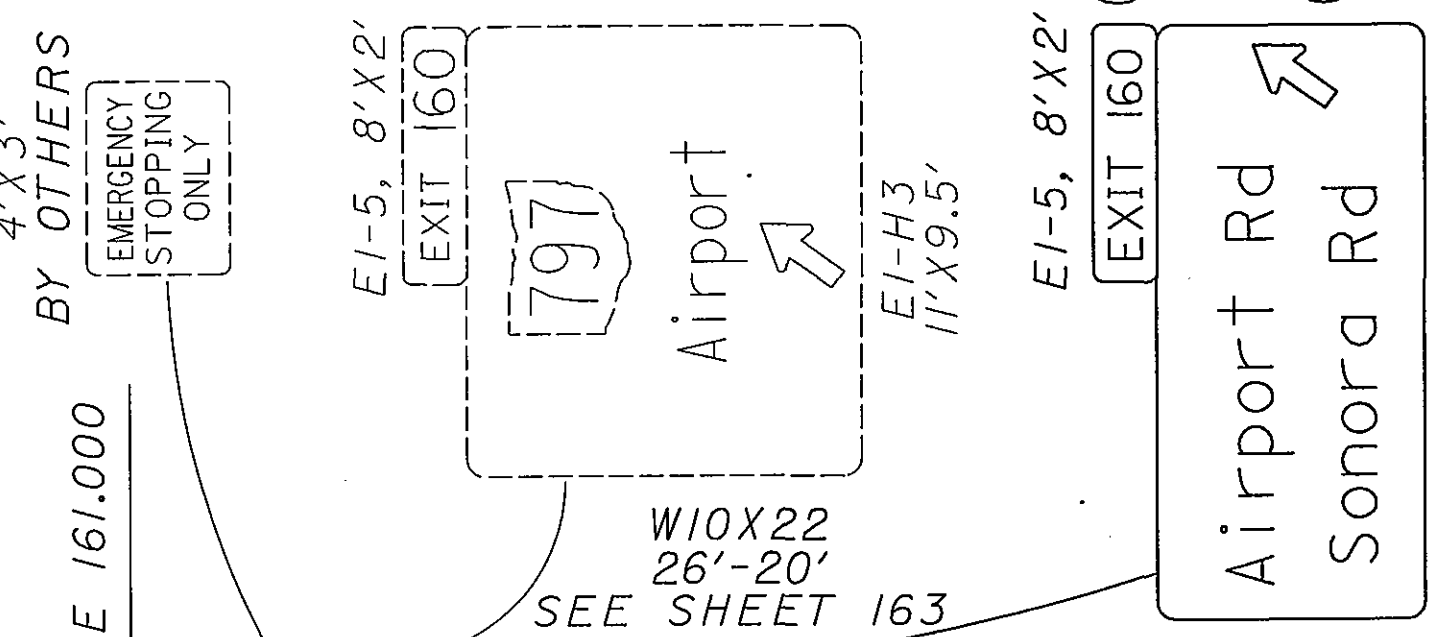
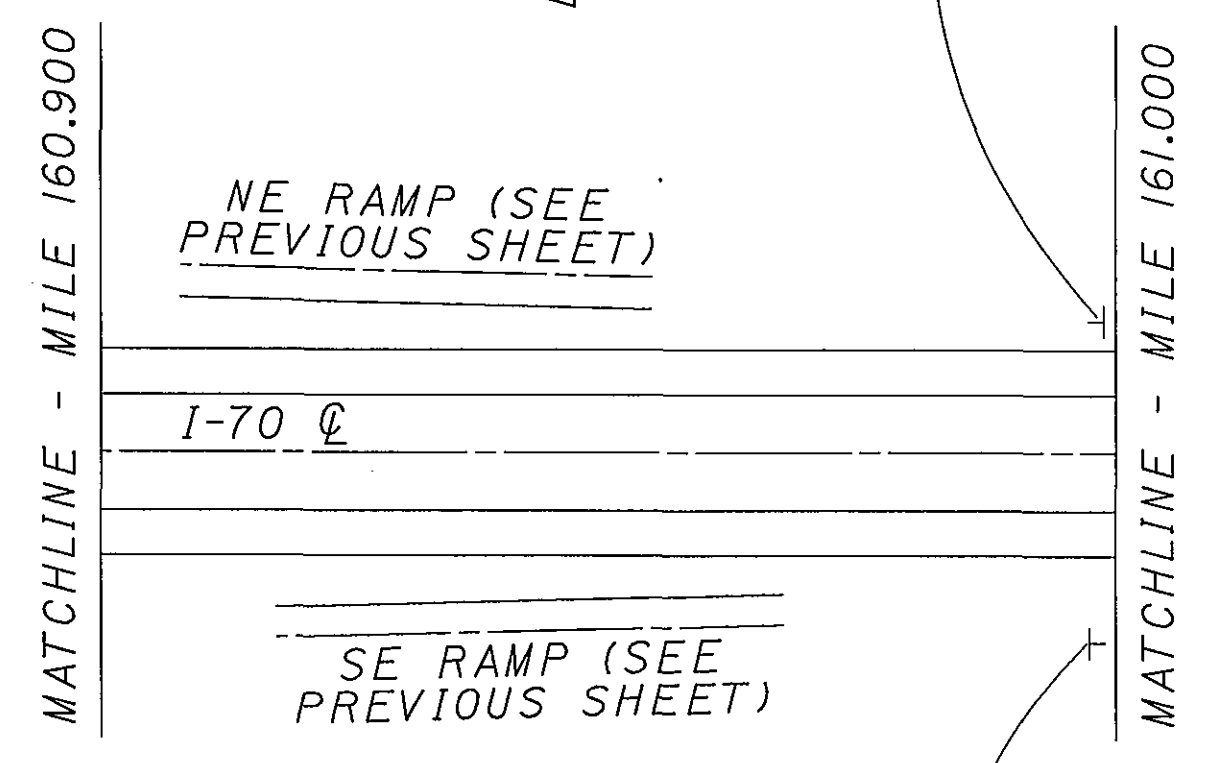
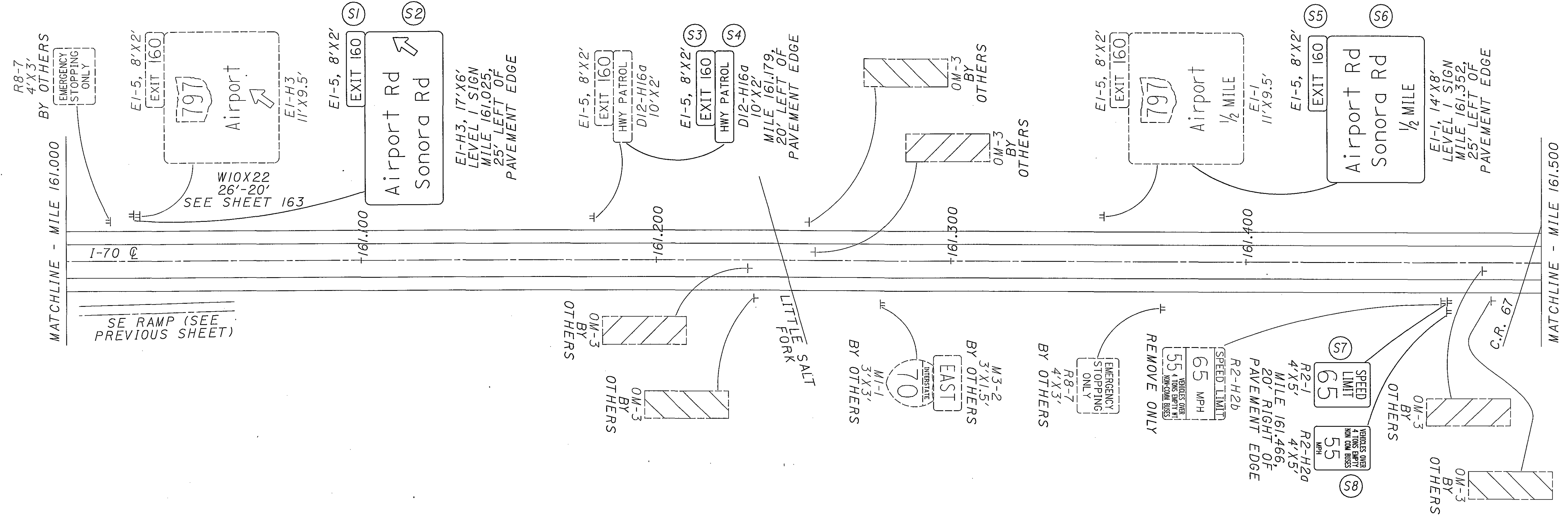

FOR QUANTITIES, SEE SHEET 150

MATCHLINE - MILE 161.500

MATCHLINE - MILE 162.000

MATCHLINE - MILE 162.000

MATCHLINE - MILE 162.500

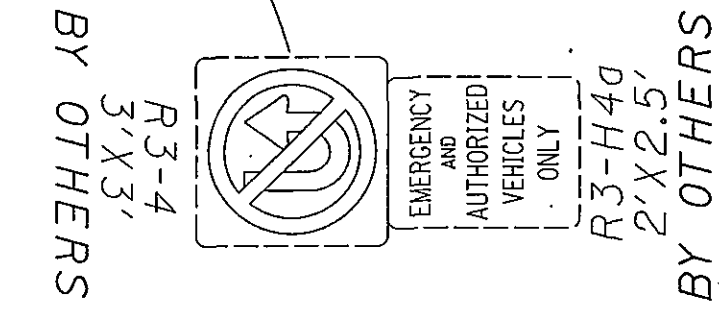
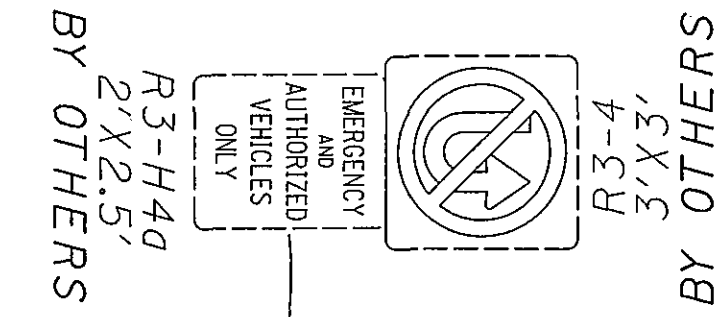
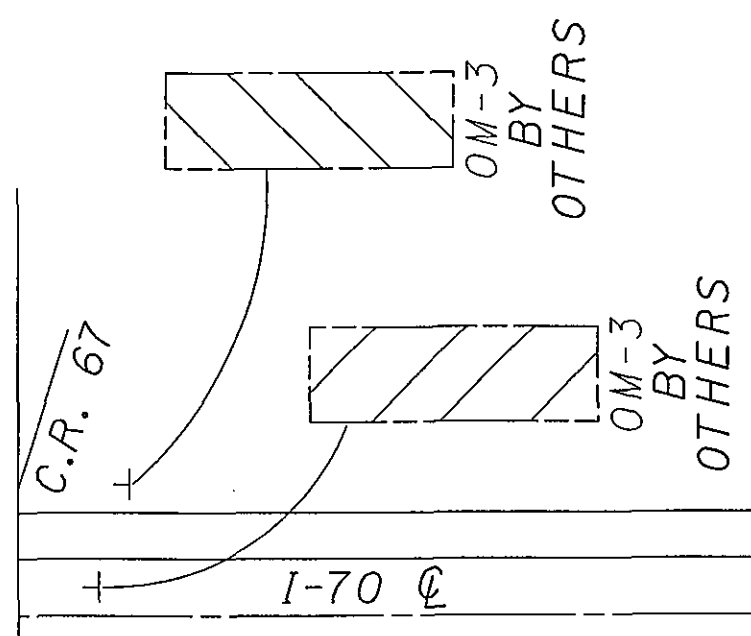

161.600

162.100

161.700

162.200

161.800

162.300

161.900

162.400

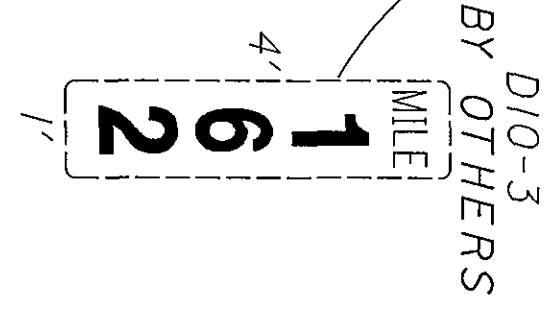
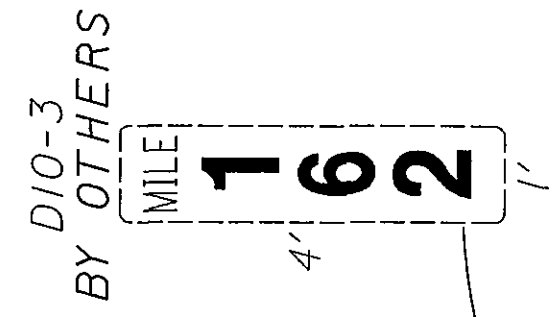
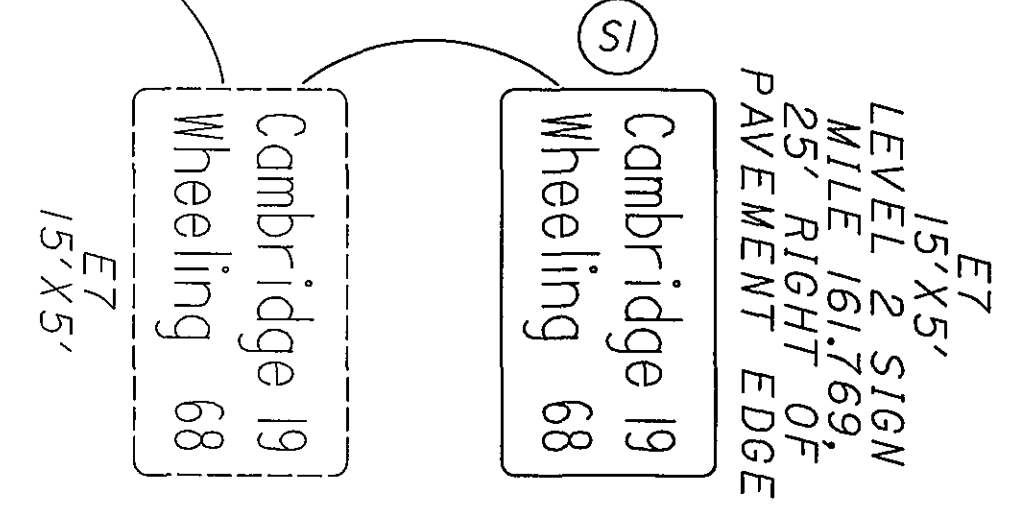
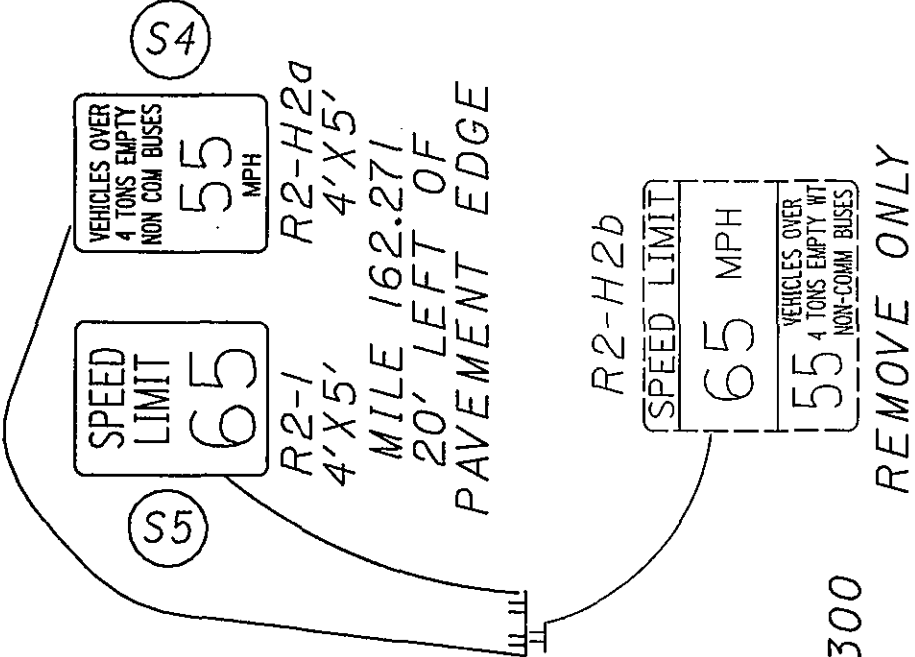
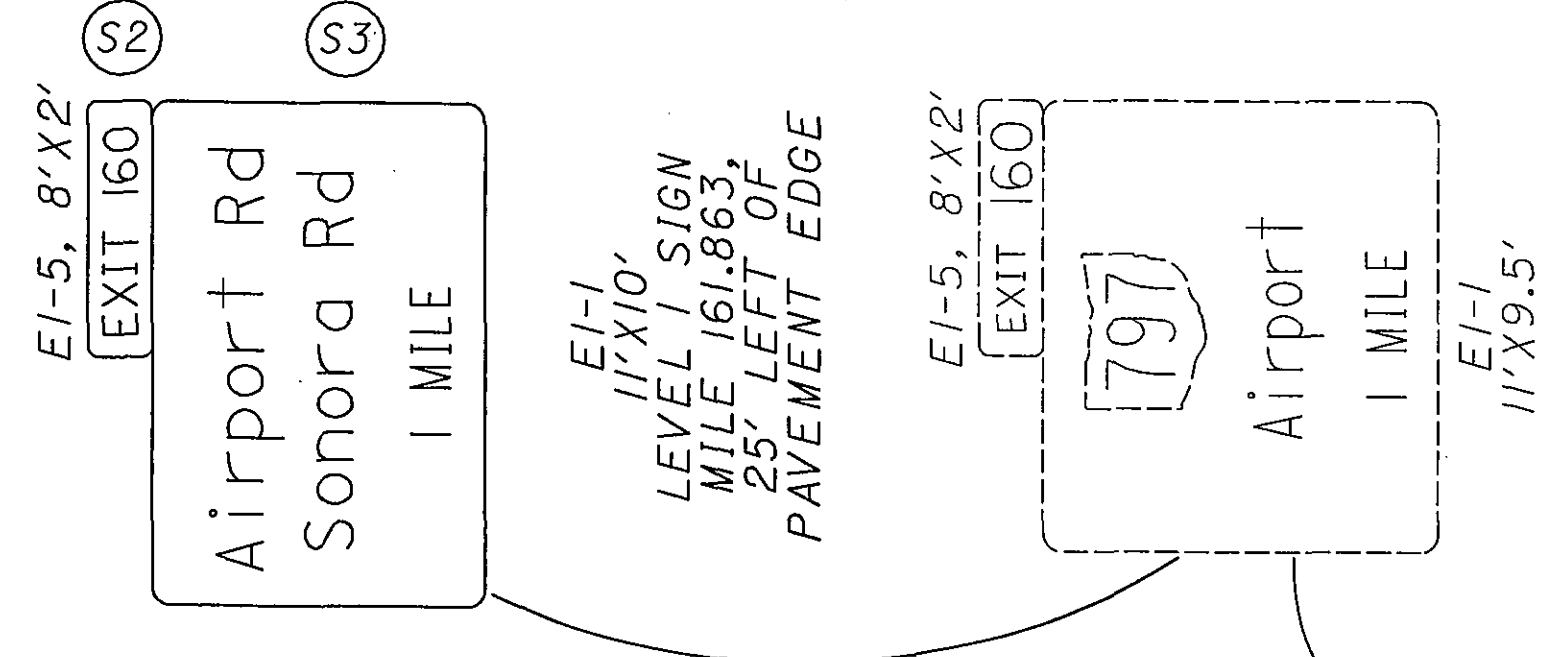

CALCULATED
JAM
CHECKED
WEB

HORIZONTAL SCALE IN FEET

MUSKINGUM COUNTY
MILE 161.500 TO MILE 162.500

D05-SIGN-FY 2005

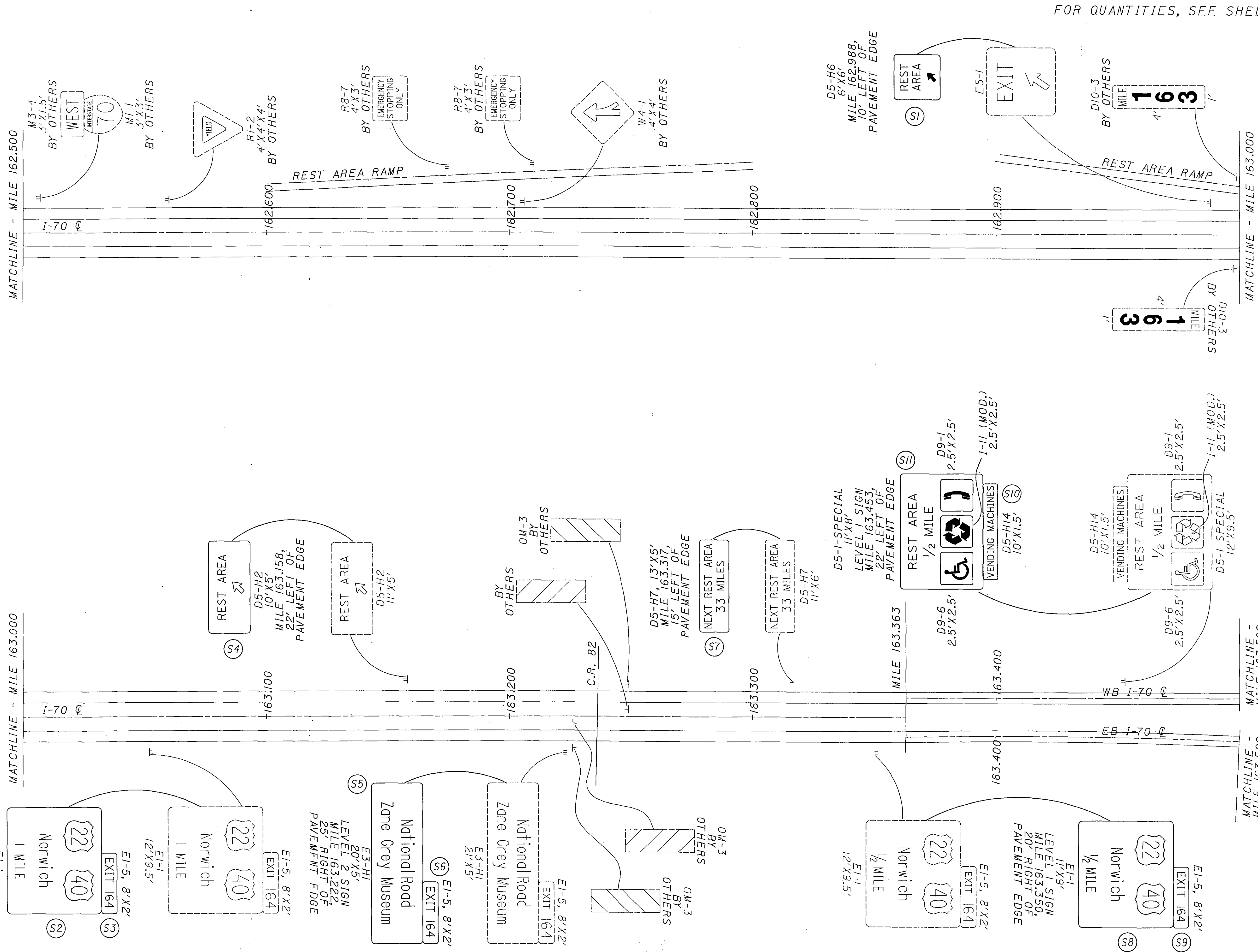

FOR QUANTITIES, SEE SHEET 150

08/16/2004 08:34:45 AM
 m:\p\0221505\22 sign inventory\project plans\plansheets\tp085170.dgn

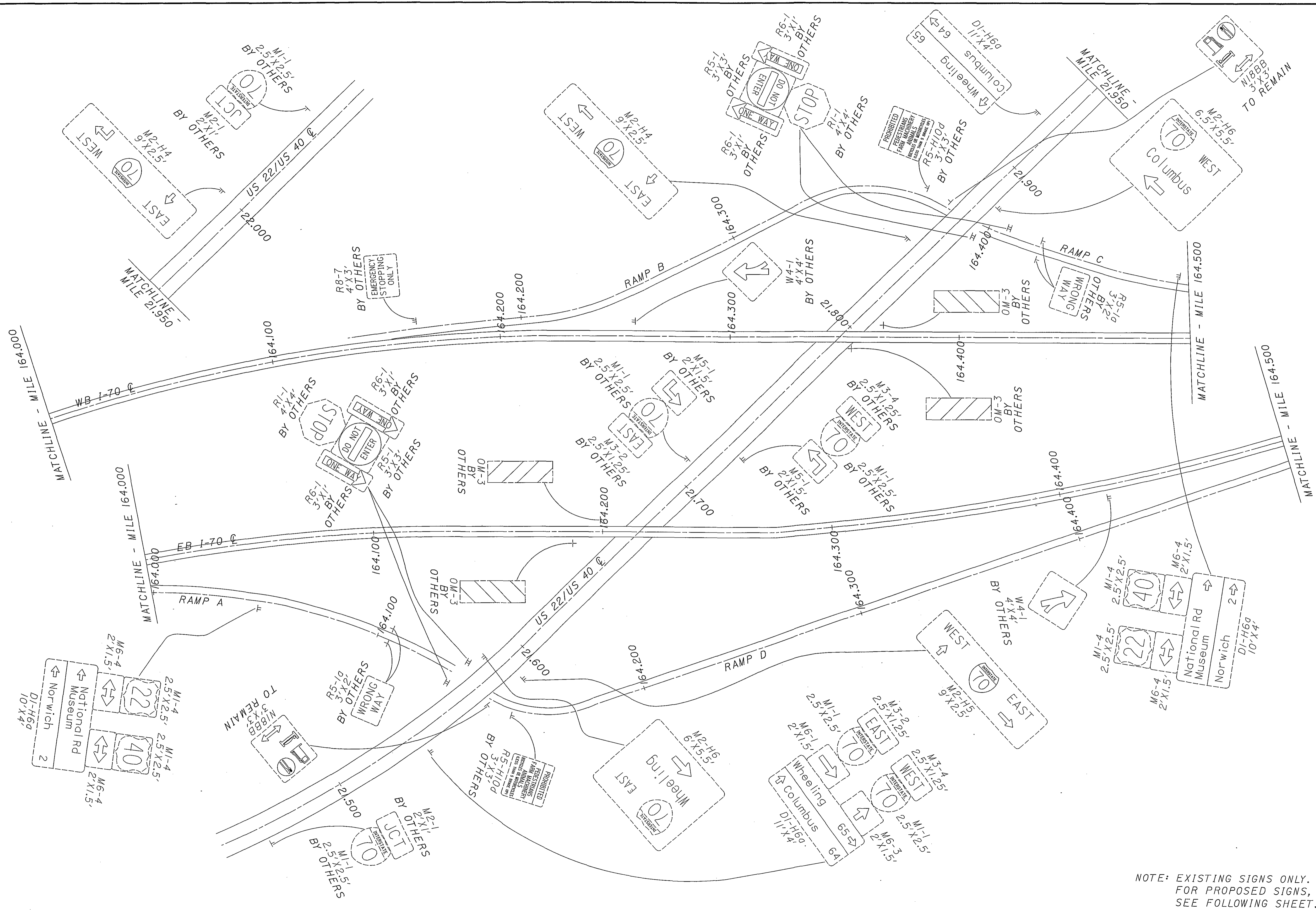

NOTE: EXISTING SIGNS ONLY.
 FOR PROPOSED SIGNS,
 SEE FOLLOWING SHEET.

0 100 200
 HORIZONTAL SCALE IN FEET

CALCULATED
 JAM
 CHECKED
 WEB

**MUSKINGUM COUNTY
 US 22/US 40 INTERCHANGE**

D05-SIGN-FY2005

90
 166

08/13/2004 03:54:32 PM
m:\proj\0221\505\22 sign inventory\project plans\plansheets\tp066170.dgn

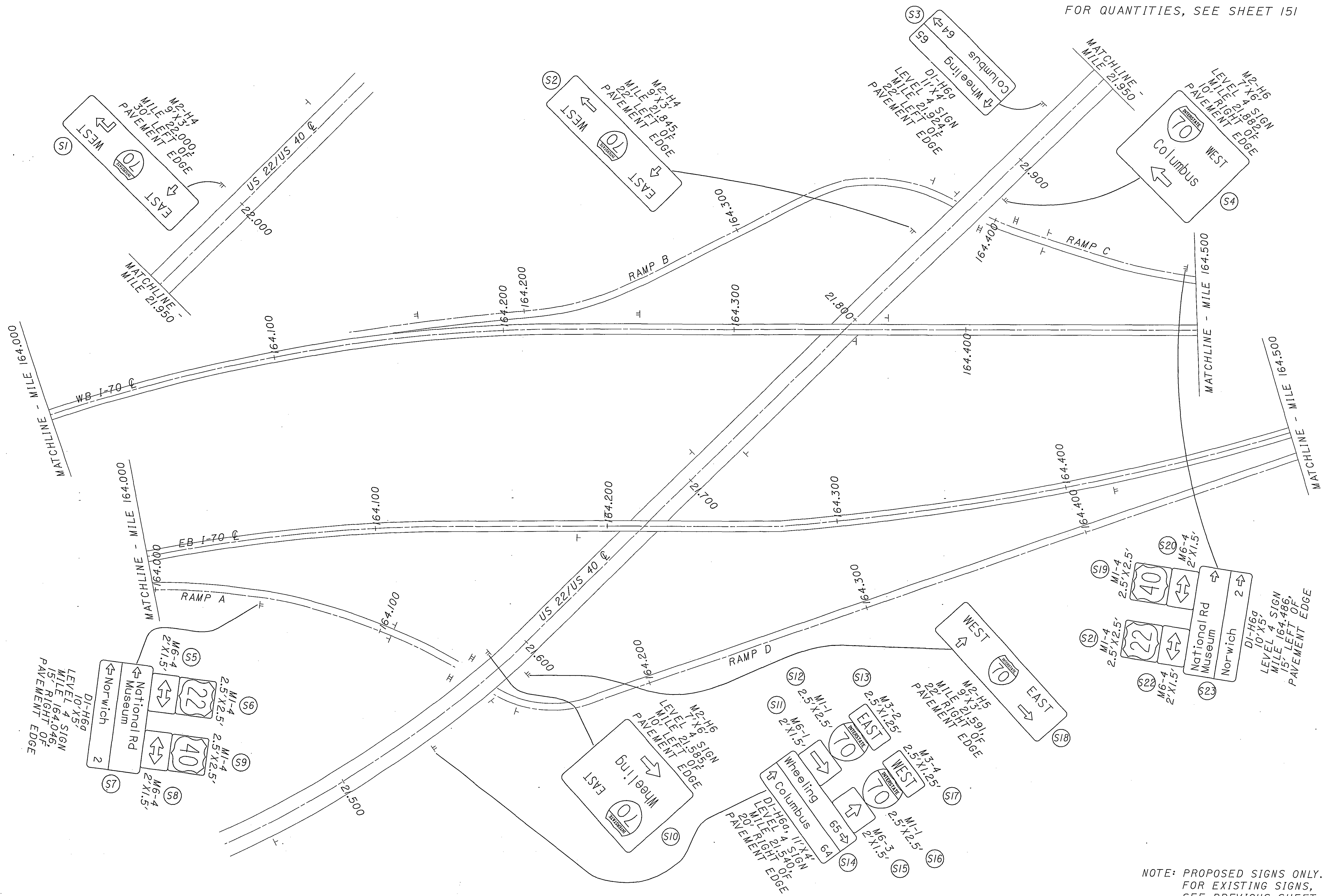

FOR QUANTITIES, SEE SHEET 151

0 100 200
HORIZONTAL SCALE IN FEET

CALCULATED	JAM
CHECKED	WEB

MUSKINGUM COUNTY
US 22/US 40 INTERCHANGE

D05 - SIGN - FY 2005

NOTE: PROPOSED SIGNS ONLY.
FOR EXISTING SIGNS,
SEE PREVIOUS SHEET.

MATCHLINE - MILE 166.000

I-70

166.100

166.200

166.300

166.400

MATCHLINE - MILE 166.500

MATCHLINE - MILE 165.500

I-70

165.600

165.700

165.800

165.900

MATCHLINE - MILE 166.000

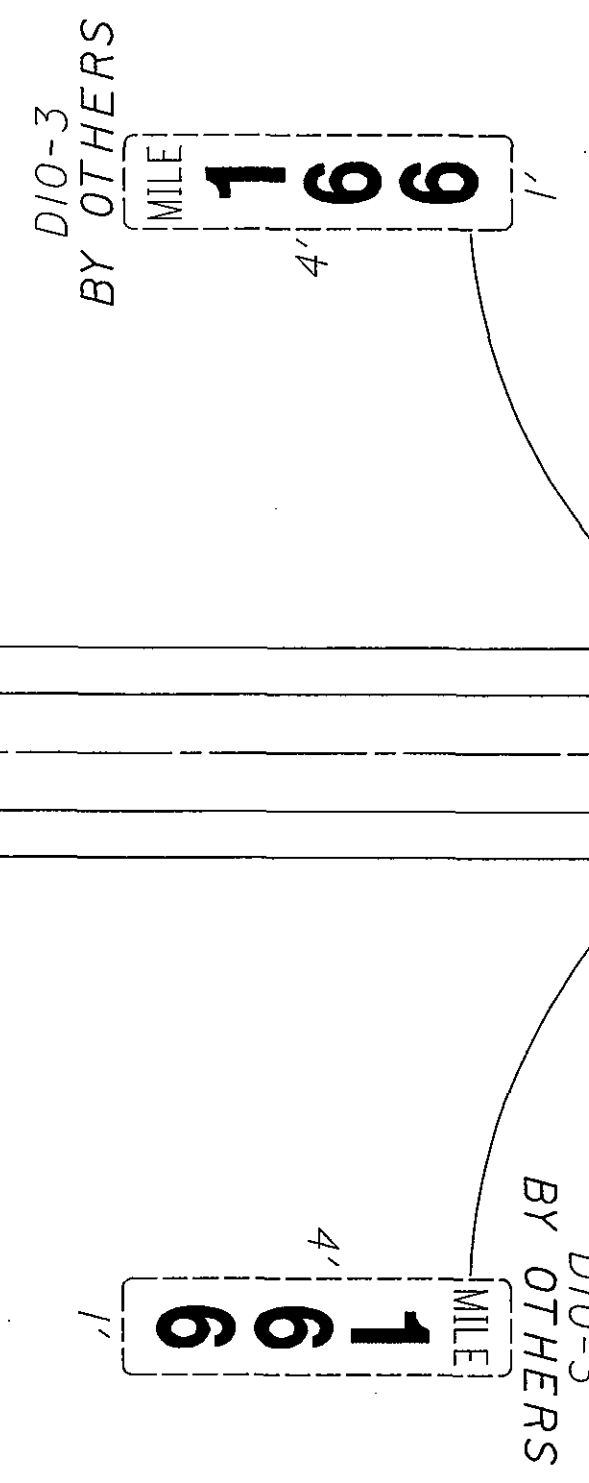
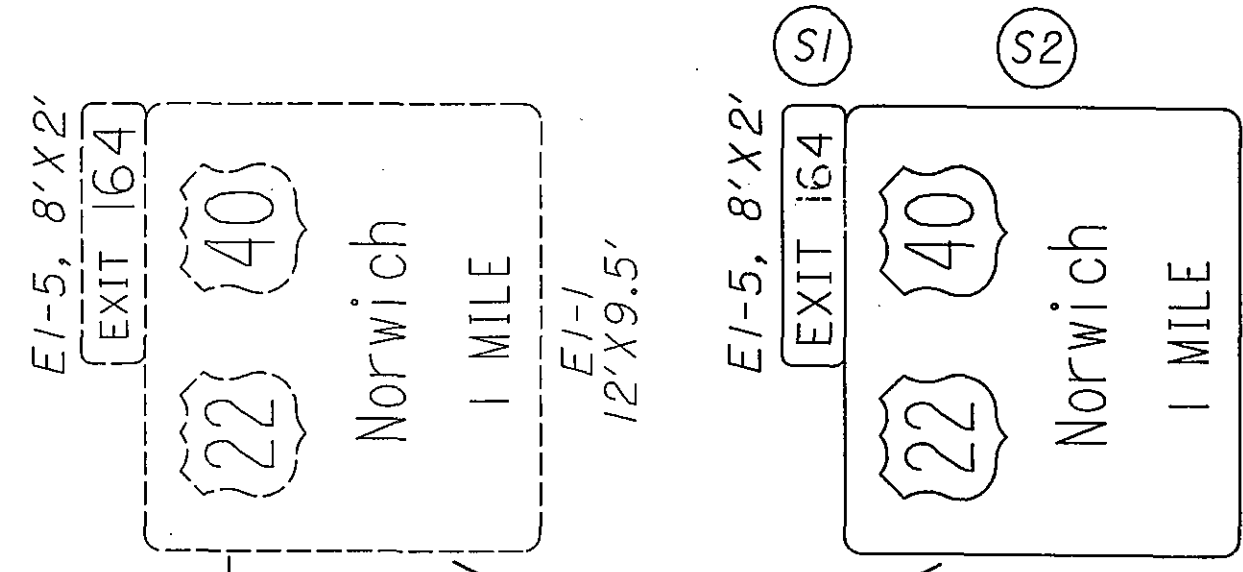

FOR QUANTITIES, SEE SHEET 151



MATCHLINE - MILE 167.000

I-70

167.100

167.200

167.300

167.400

T.R. 436

MATCHLINE - MILE 167.500

MATCHLINE - MILE 166.500

I-70

166.600

166.700

166.800

166.900

C.R. 107

MATCHLINE - MILE 167.000

167

D10-3
BY OTHERS
MILE
4'
1'

167

D10-3
BY OTHERS
MILE
4'
1'

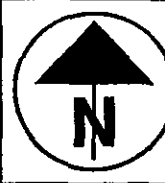

MATCHLINE - MILE 168.000

I-70

168,100

168,200

168,300

168,400

MATCHLINE - MILE 168.500

MATCHLINE - MILE 167.500

I-70

167,600

167,700

167,800

167,900

MATCHLINE - MILE 168.000

BY OTHERS
R3-4
3'X3'
EMERGENCY
AND
AUTHORIZED
VEHICLES
ONLY
R3-H4d
2'X2.5'

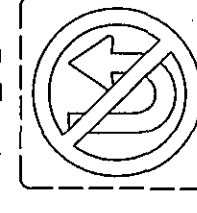

BY OTHERS
R3-4
3'X3'
EMERGENCY
AND
AUTHORIZED
VEHICLES
ONLY
R3-H4d
2'X2.5'

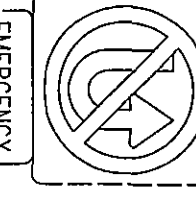

BY OTHERS
D10-3
MILE
168
4'

BY OTHERS
D10-3
MILE
168
4'

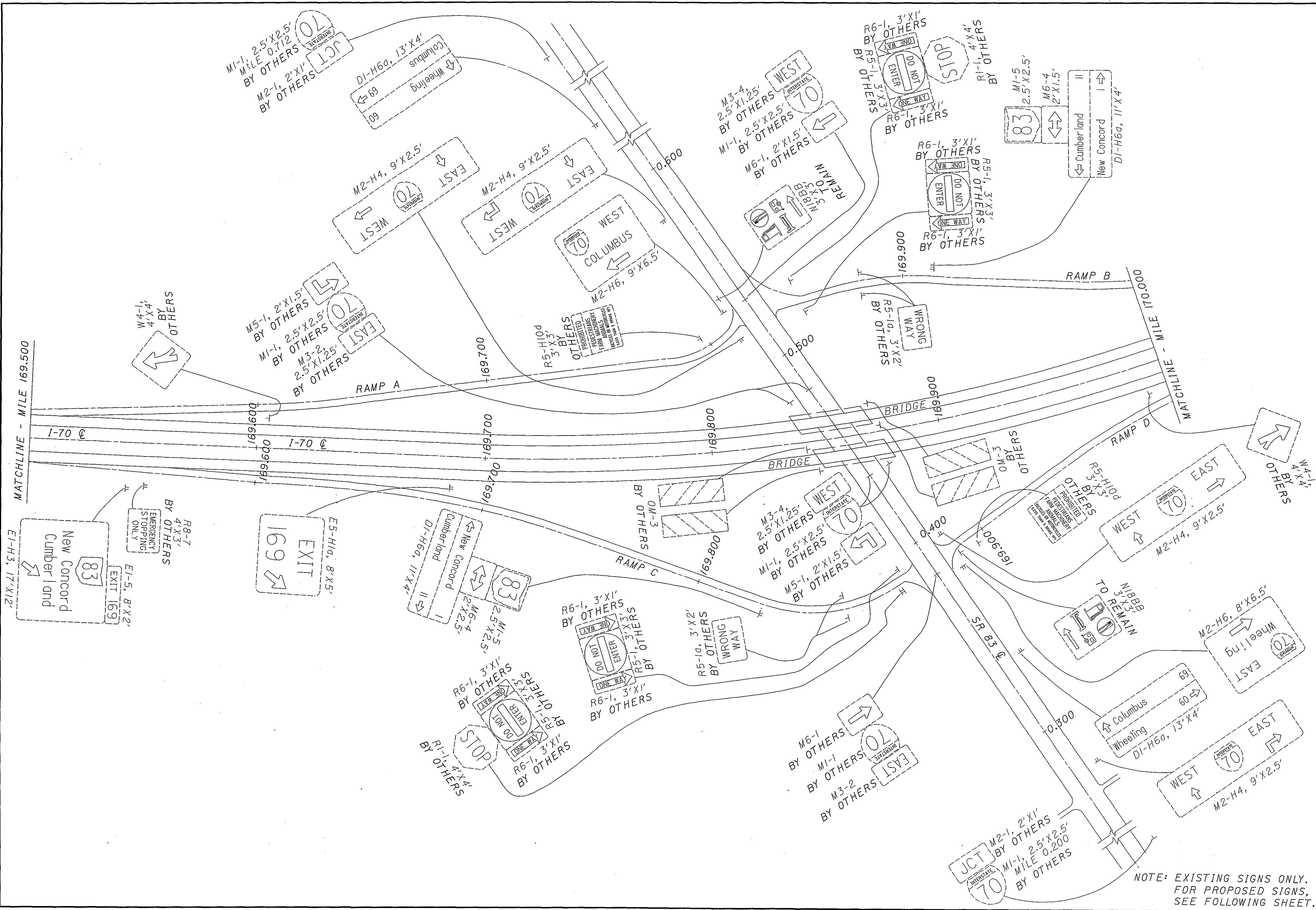

NOTE: EXISTING SIGNS ONLY.
FOR PROPOSED SIGNS,
SEE FOLLOWING SHEET.

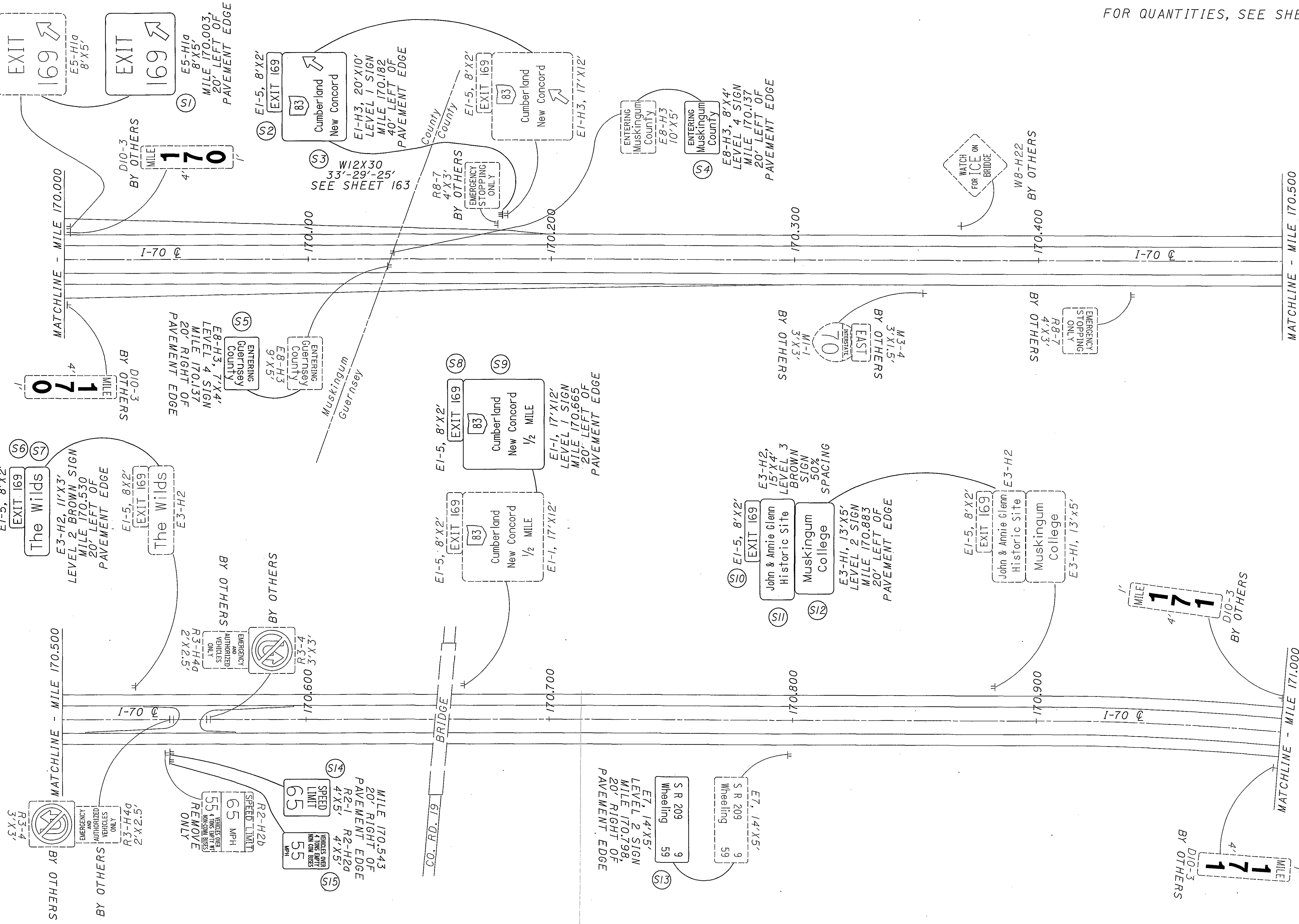

FOR QUANTITIES, SEE SHEET 152



CALCULATED	KSD
CHECKED	WEB

**MUSKINGUM & GUERNSEY COUNTY
 MILE 170.000 TO MILE 171.000**

D05-SIGN-FY2005

MATCHLINE - MILE 171.500

MATCHLINE - MILE 171.000

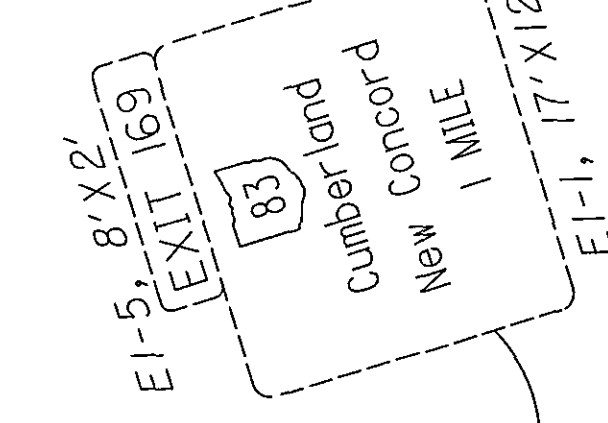
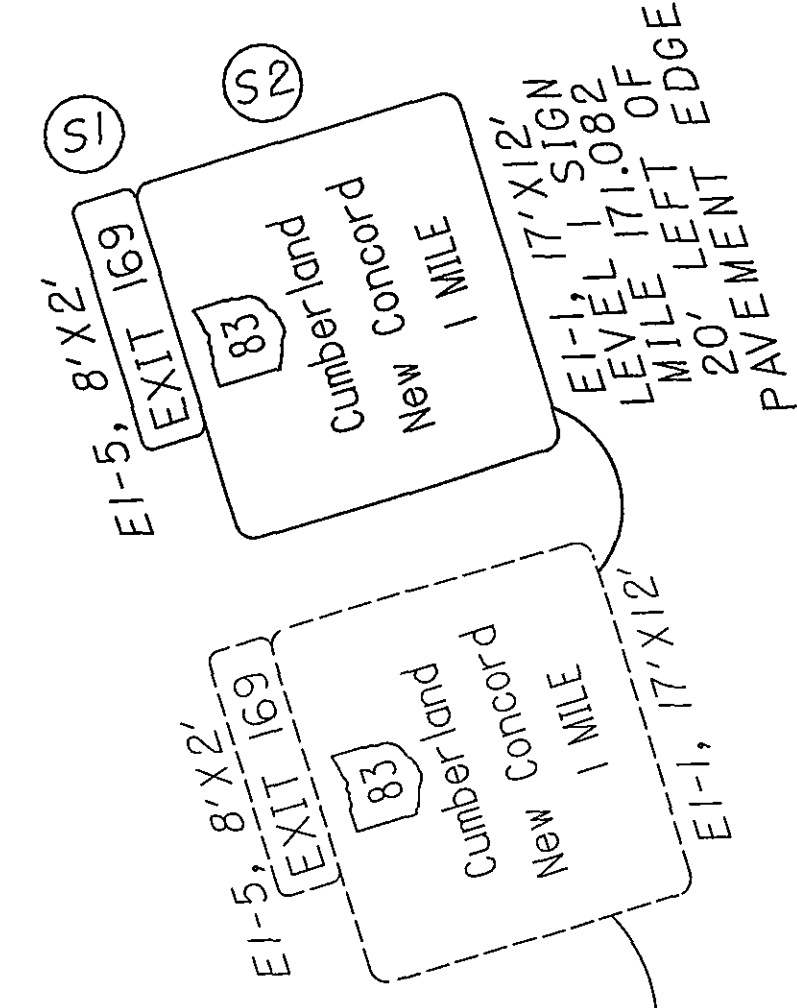

I-70

171.600

171.700

171.800

171.900

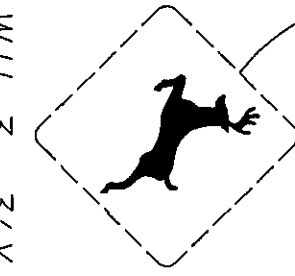
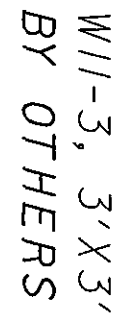
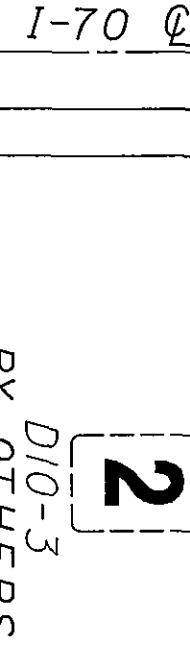

MATCHLINE - MILE 172.000

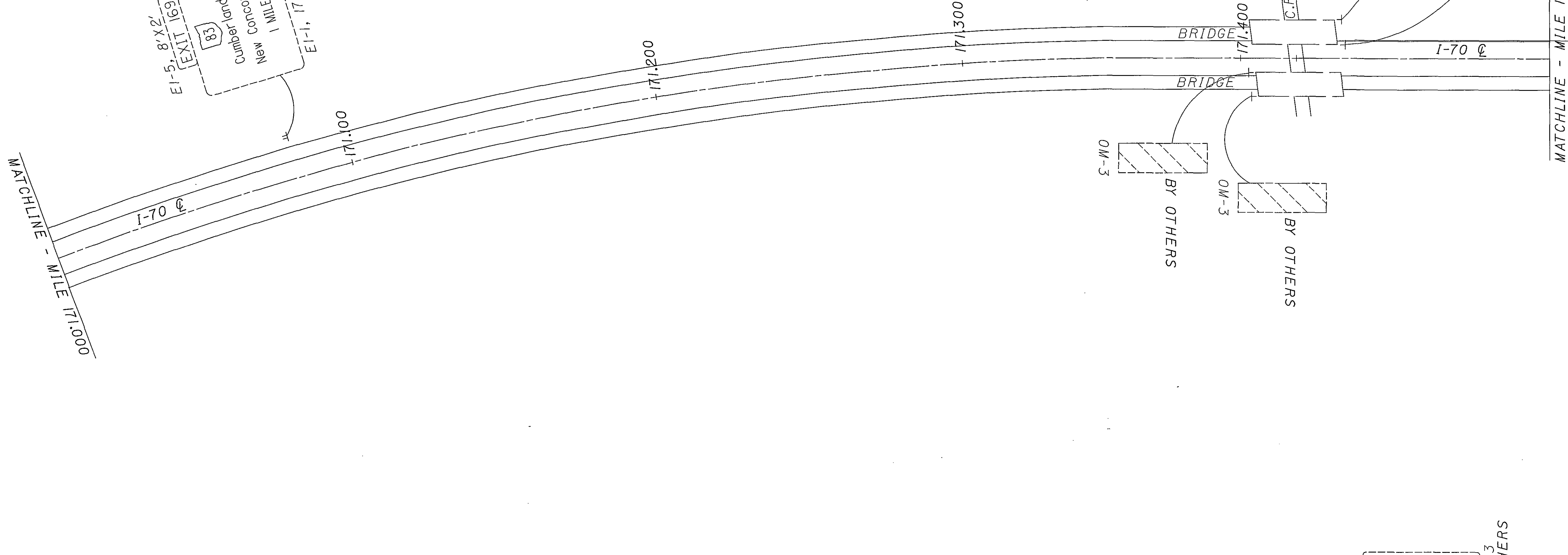

FOR QUANTITIES, SEE SHEET 152

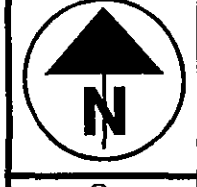

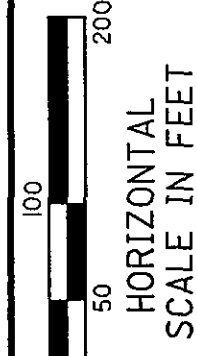

CALCULATED
 KSD
 CHECKED
 WEB

**GUERNSEY COUNTY
 MILE 172.000 TO MILE 173.000**

D05-SIGN-FY2005

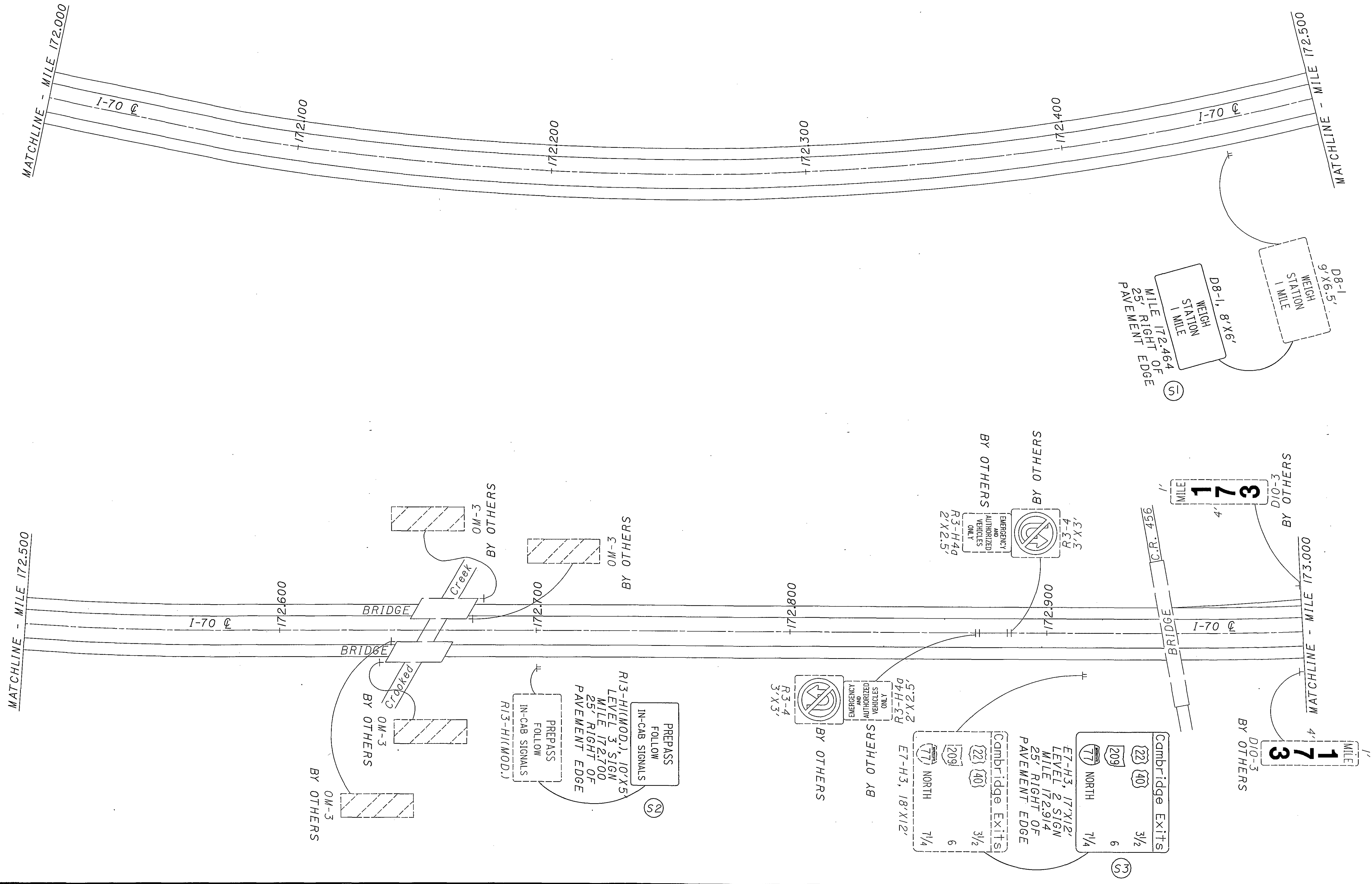

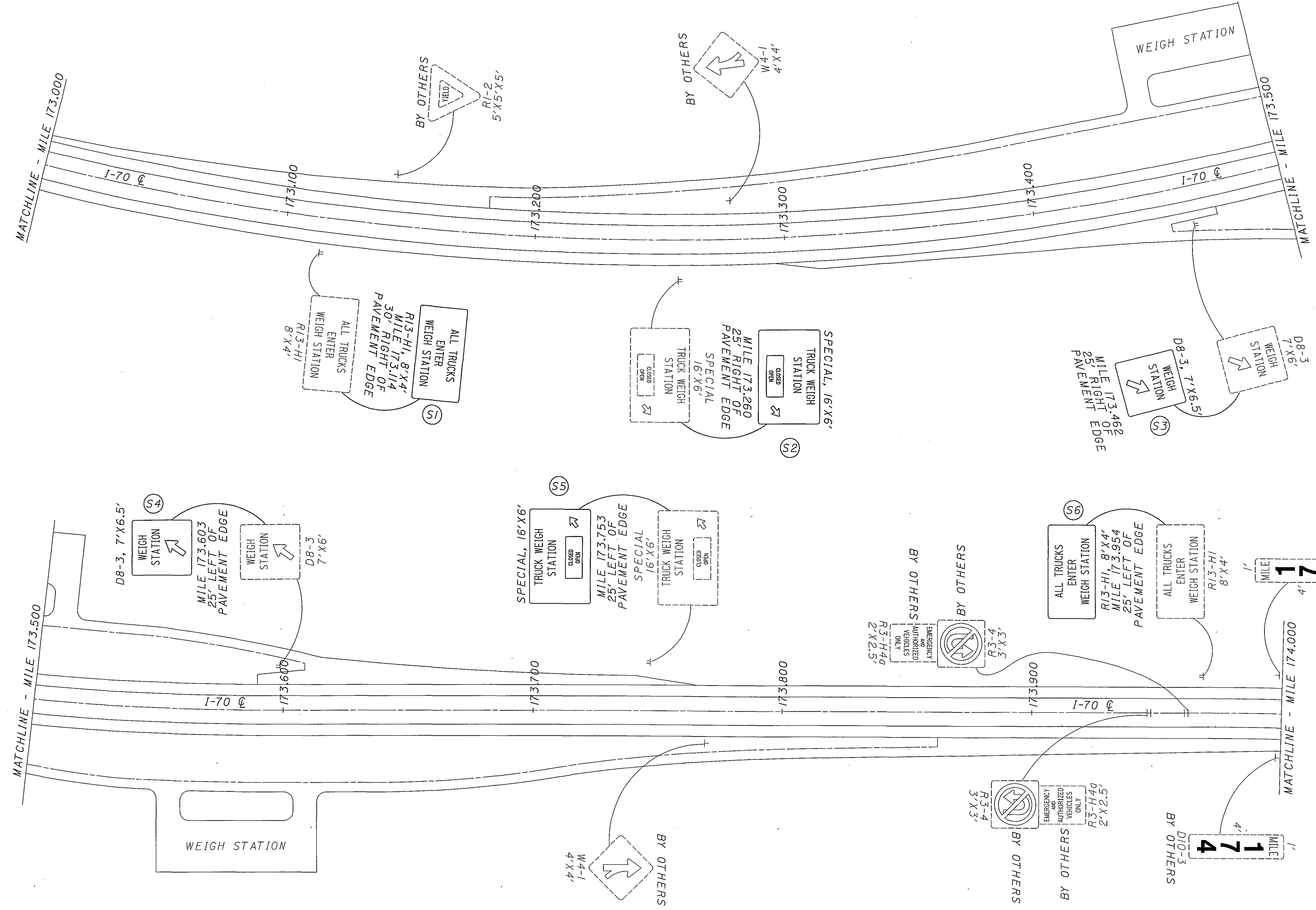

BY OTHERS

BY OTHERS

BY OTHERS

BY OTHERS

BY OTHERS

BY OTHERS

BY OTHERS

BY OTHERS

BY OTHERS

BY OTHERS

BY OTHERS

BY OTHERS

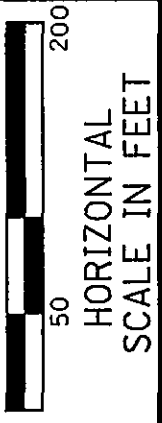

CALCULATED KSD
CHECKED WEB

**GUERNSEY COUNTY
SR 723 INTERCHANGE**

D05 - SIGN - FY2005

105
166

08/13/2004
03:54:56
m:\p\1022\1605\22 sign inventory\project plans\plansheets\160070.dgn

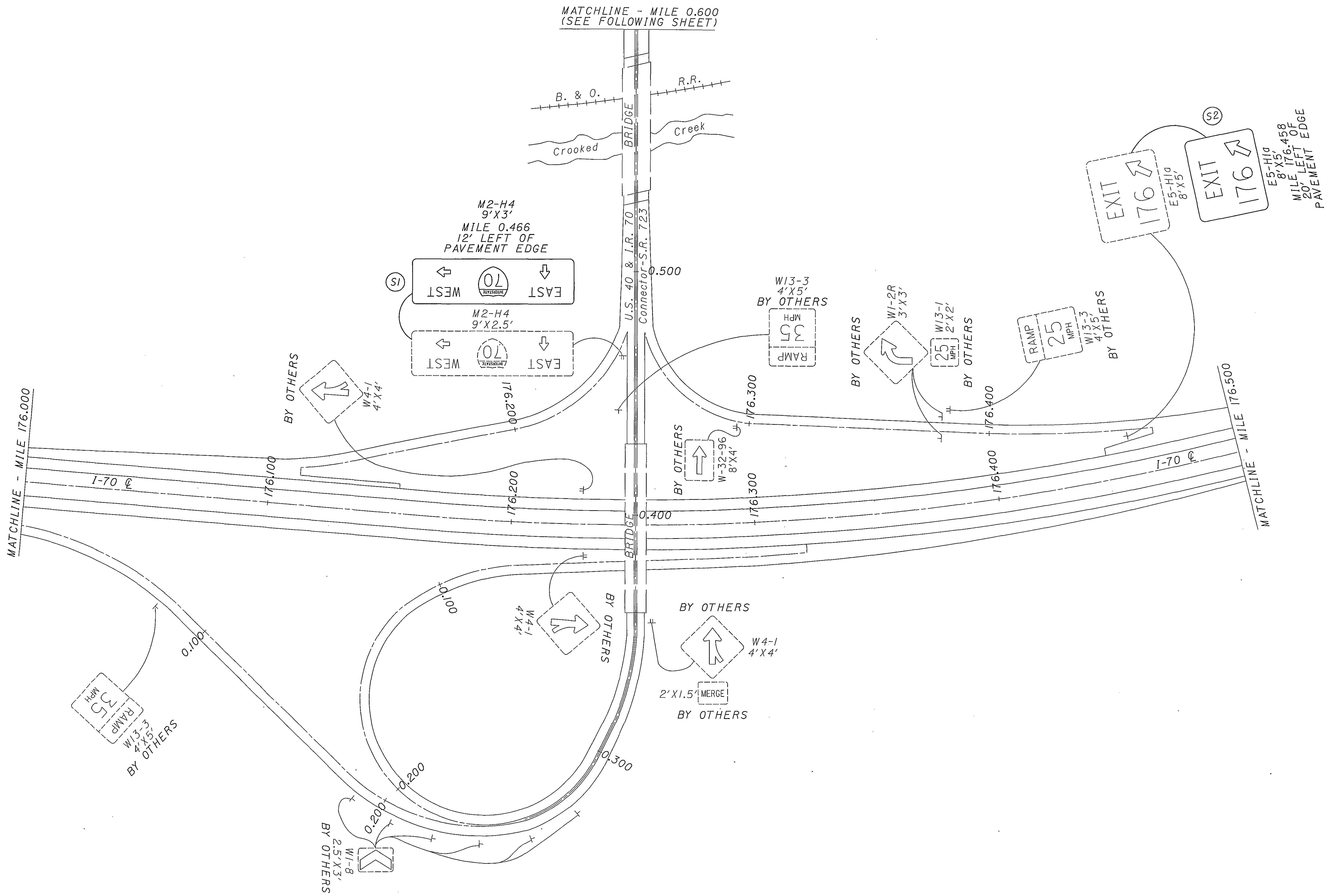



CALCULATED KSD CHECKED WEB

GUERNSEY COUNTY SR 723 INTERCHANGE

D05-SIGN-FY2005

106
166

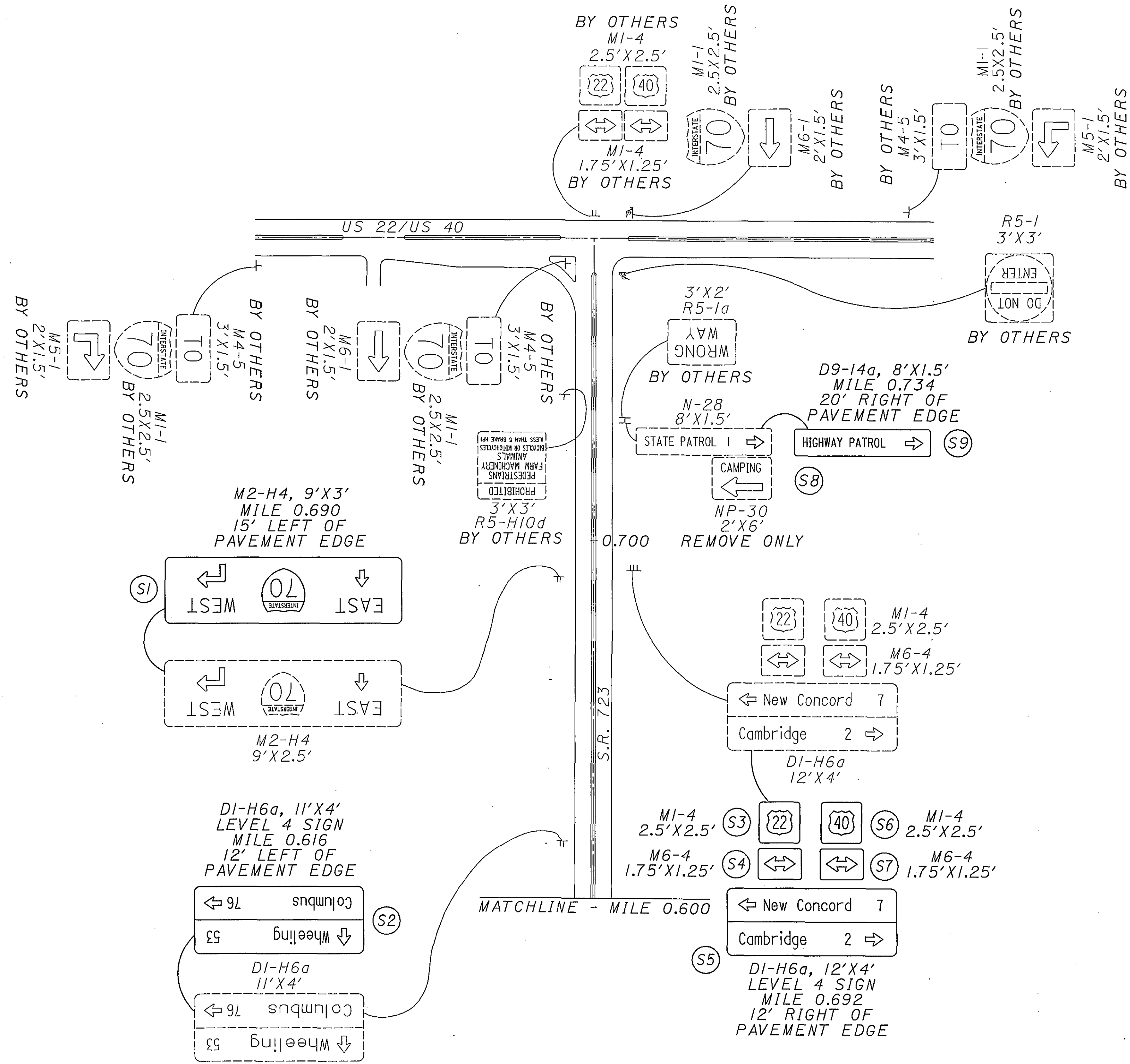

08/13/2004 03:24:36 PM m:\pro\022\1505\22 sign inventory\project plans\plansheets\tp010170.dgn

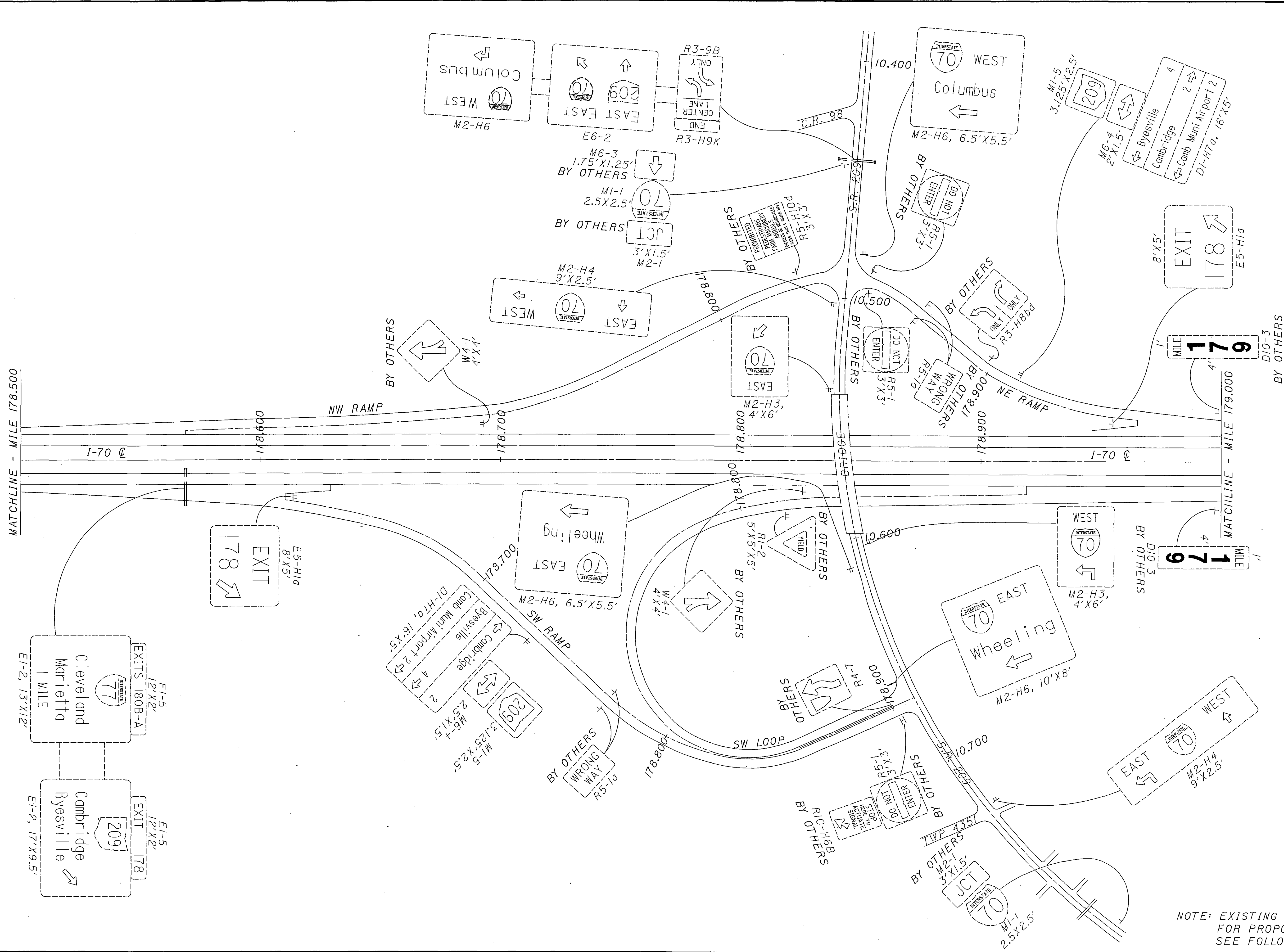

NOTE: EXISTING SIGNS ONLY,
 FOR PROPOSED SIGNS,
 SEE FOLLOWING SHEET.

FOR QUANTITIES, SEE SHEET 154

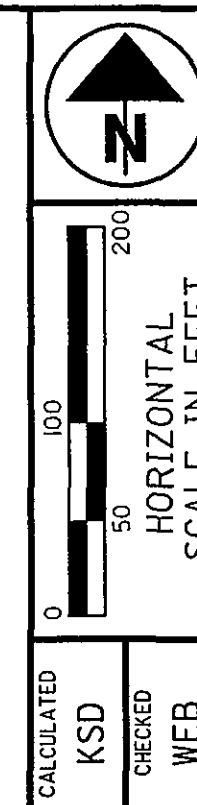

**GUERNSEY COUNTY
SR 209 INTERSECTION**

D05-SIGN-FY2005

110
166

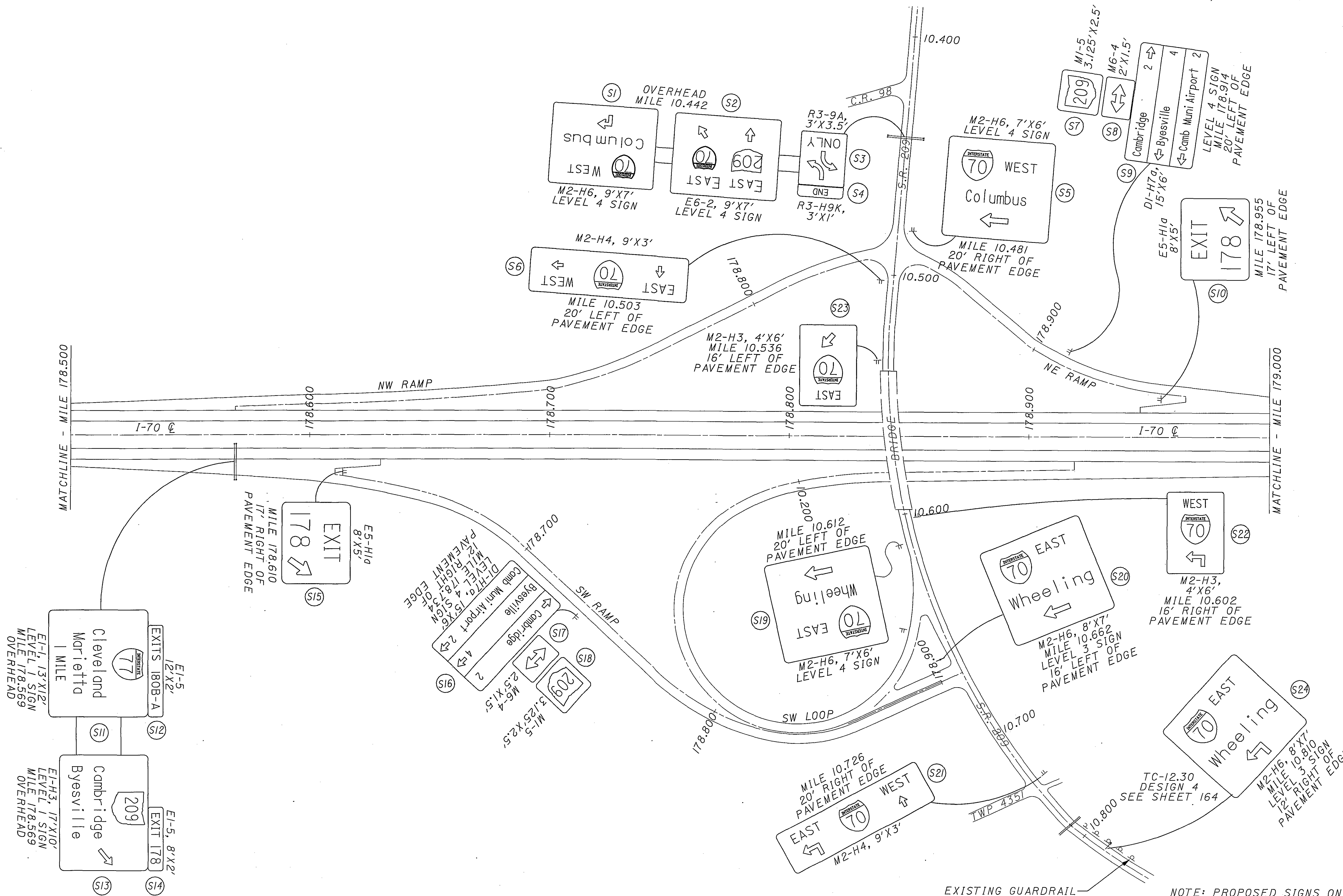

NOTE: PROPOSED SIGNS ONLY,
FOR EXISTING SIGNS,
SEE PREVIOUS SHEET.

08/15/2004
03:54:58
c:\p01\0221\0505\22 sign inventory\project plans\plansheets\1p05170.dgn

FOR QUANTITIES, SEE SHEET 155

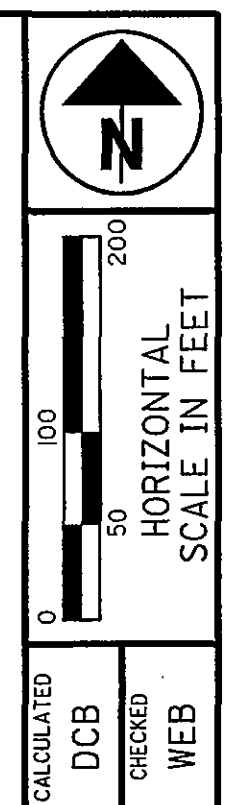
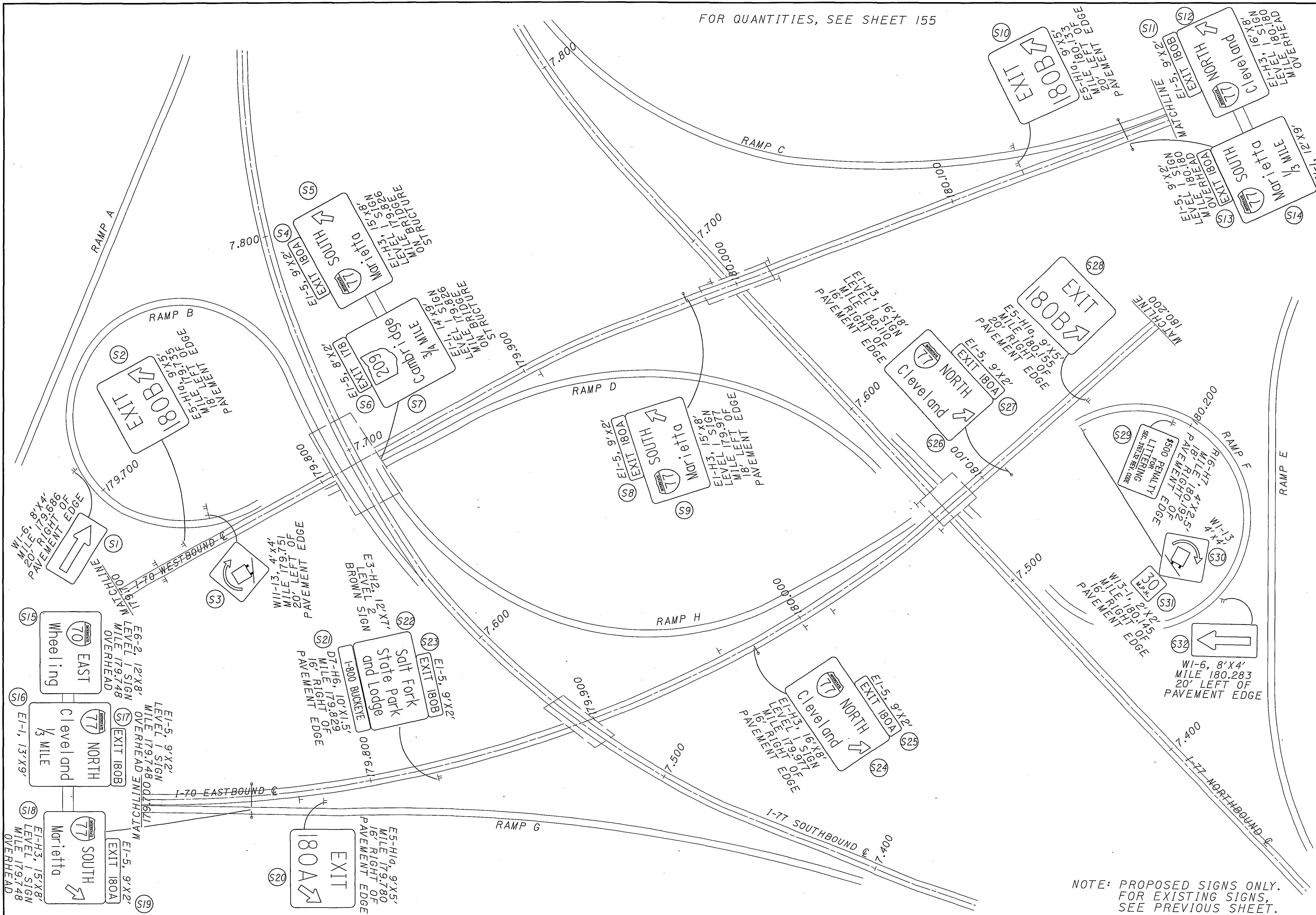

**GUERNSEY COUNTY
I-77 INTERCHANGE**

D05-SIGN-FY2005

113
166

NOTE: PROPOSED SIGNS ONLY.
FOR EXISTING SIGNS,
SEE PREVIOUS SHEET.

08/15/2004
140064
m:\p\o\1\022\1505\22 sign inventory\project plans\plansheets\tp08170.dgn

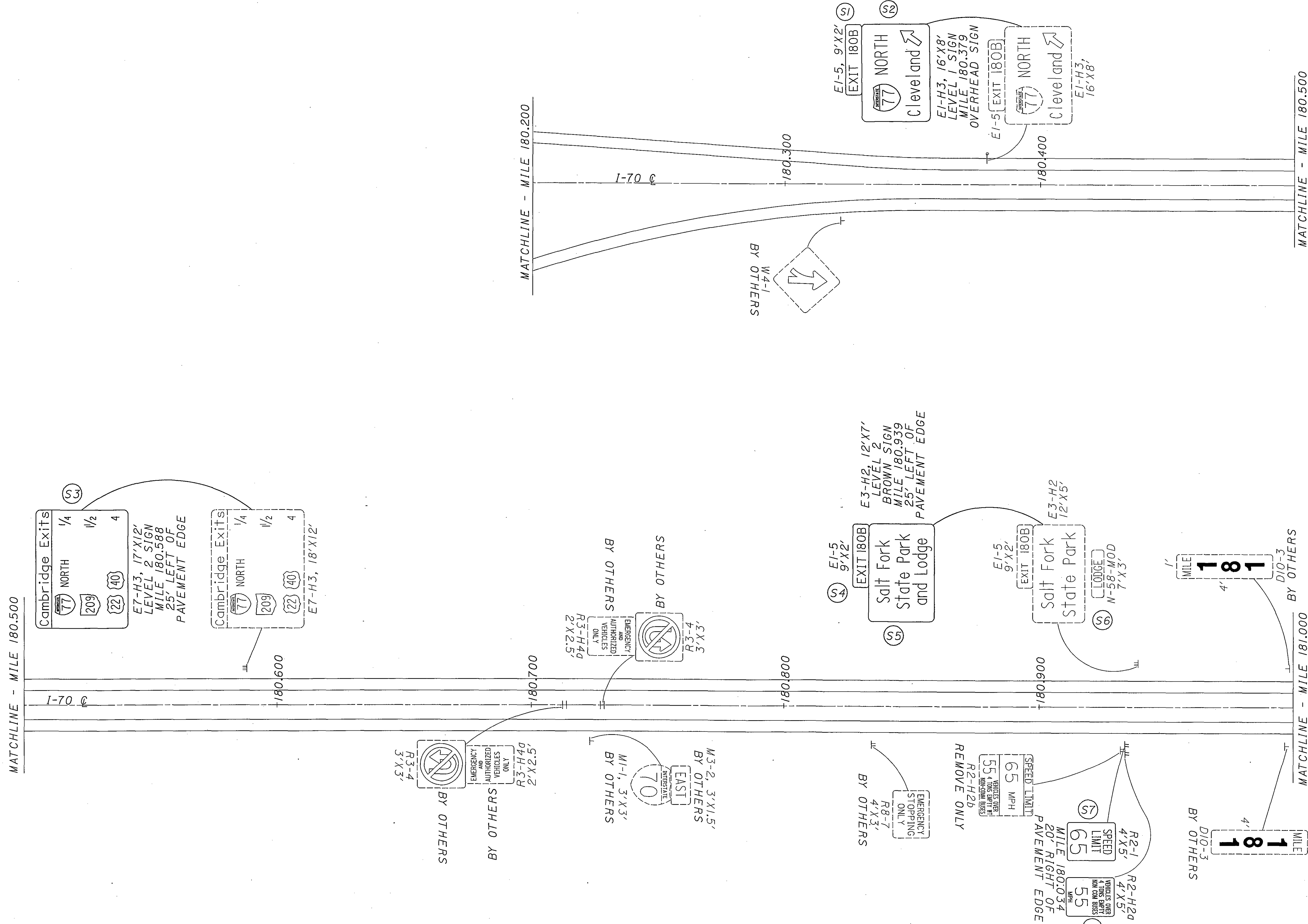

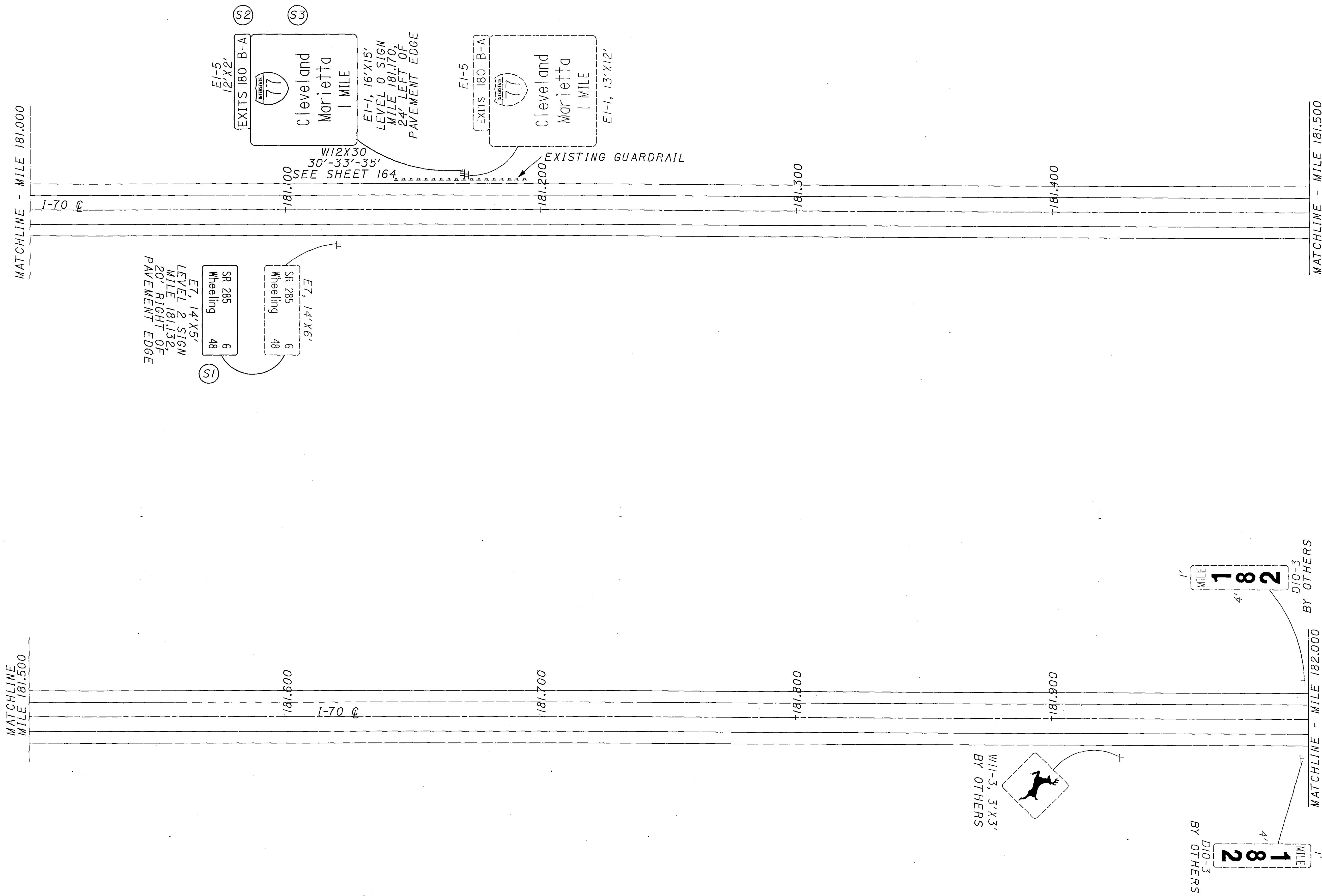

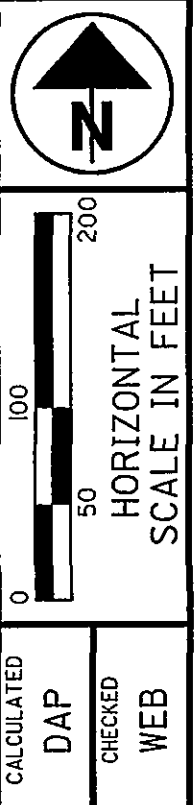
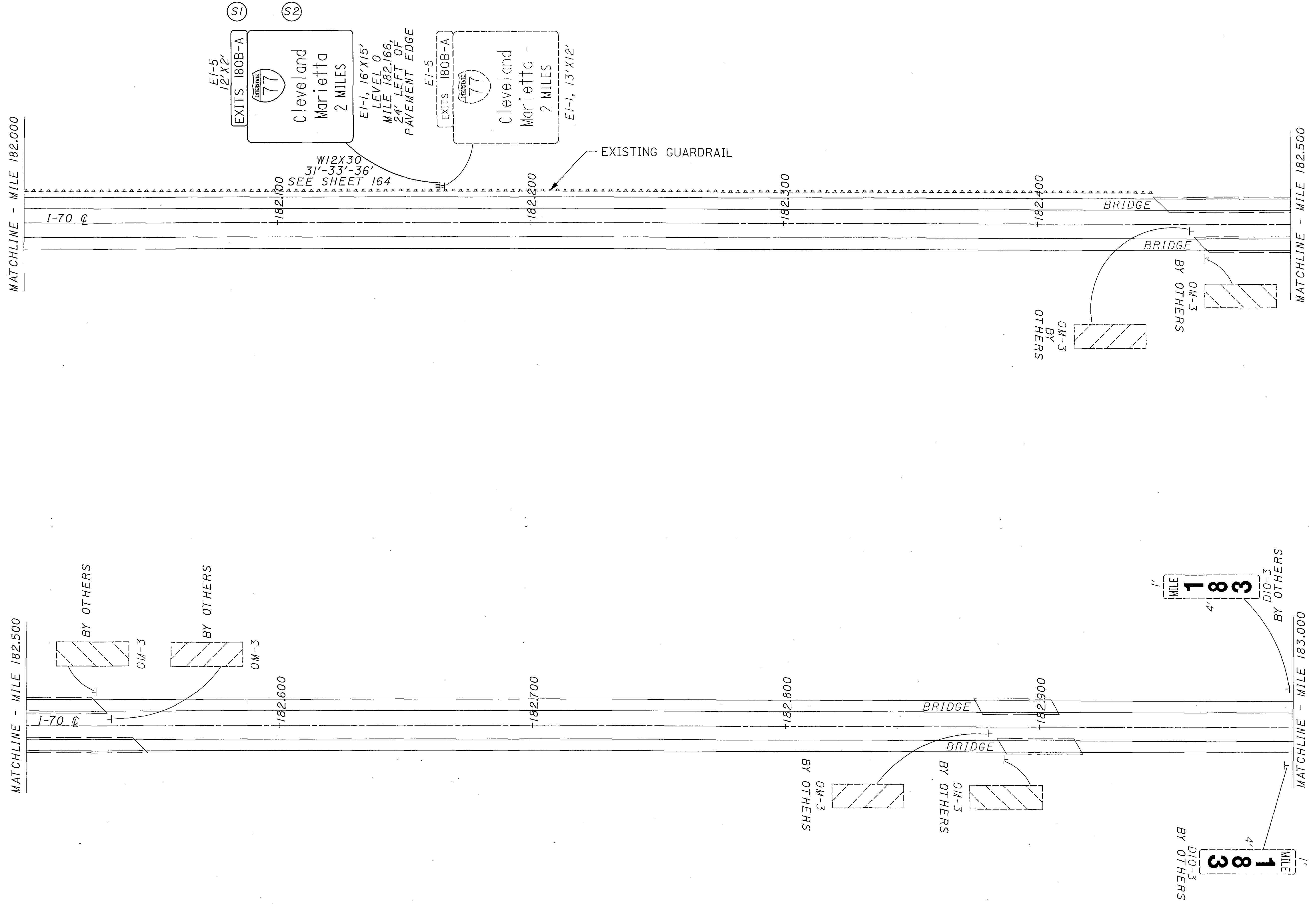

CALCULATED
 DAP
 CHECKED
 WEB

GUERNSEY COUNTY
MILE 182.000 TO MILE 183.000

D05-SIGN-FY2005

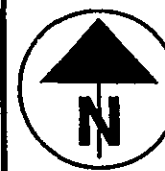
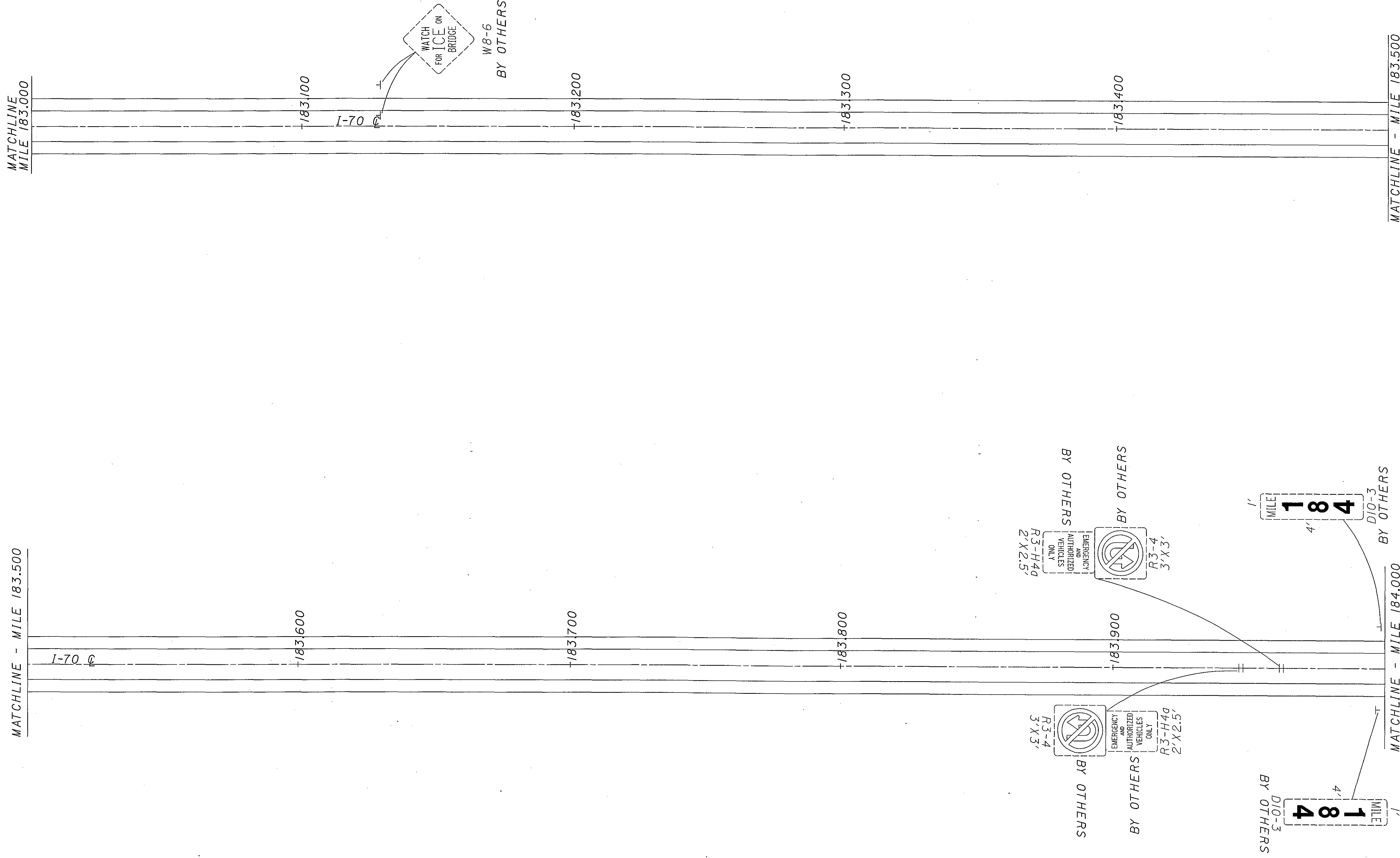

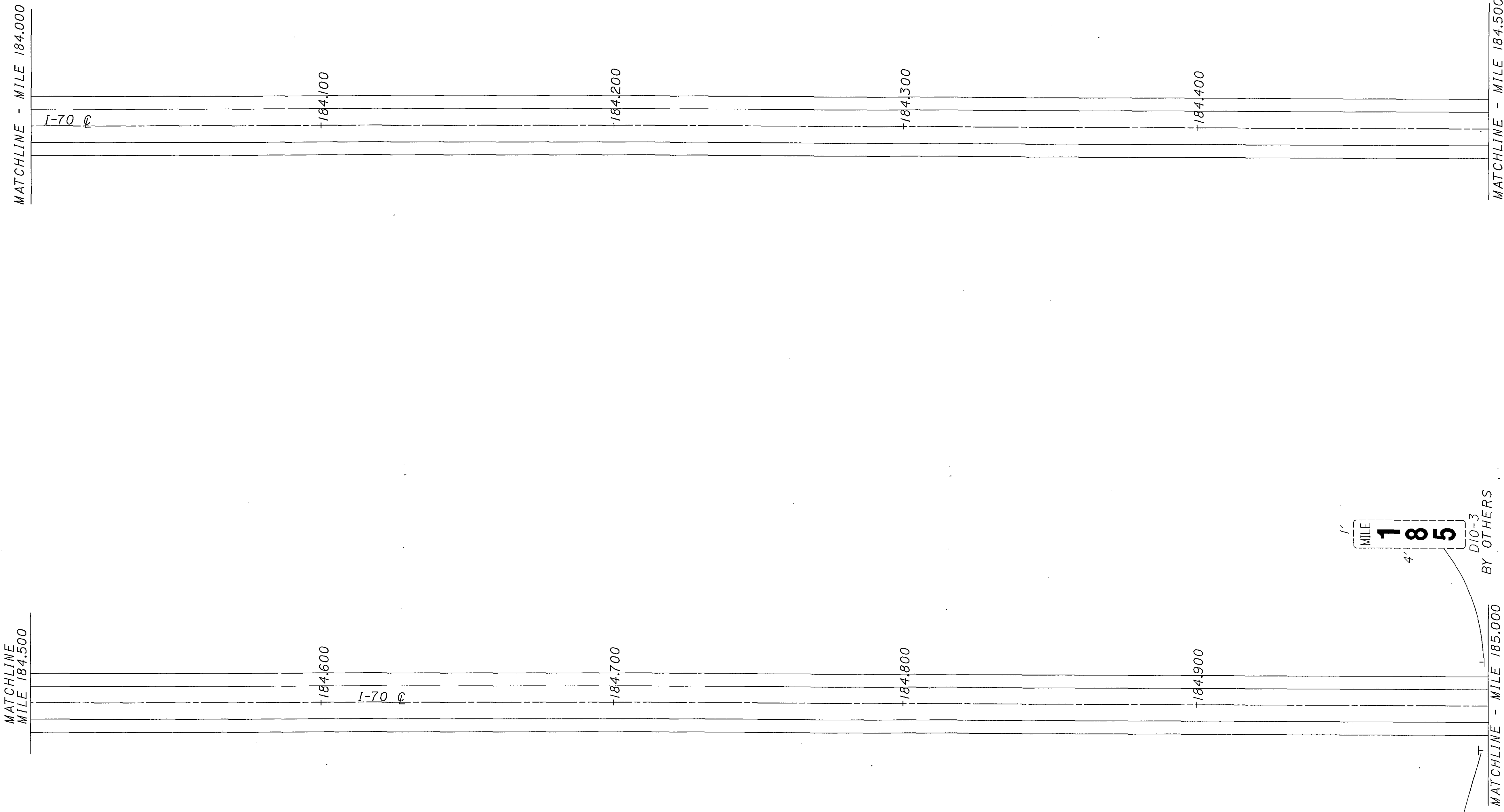

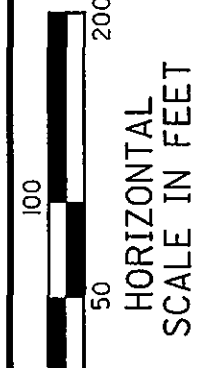

CALCULATED
 DAP
 CHECKED
 WEB

GUERNSEY COUNTY
MILE 185.000 TO MILE 186.000

D05-SIGN-FY2005

MATCHLINE - MILE 185.000

MATCHLINE - MILE 185.500

I-70

I-70

185.100

185.600

185.200

185.700

185.300

185.800

185.400

185.900

MATCHLINE - MILE 185.500

MATCHLINE - MILE 186.000

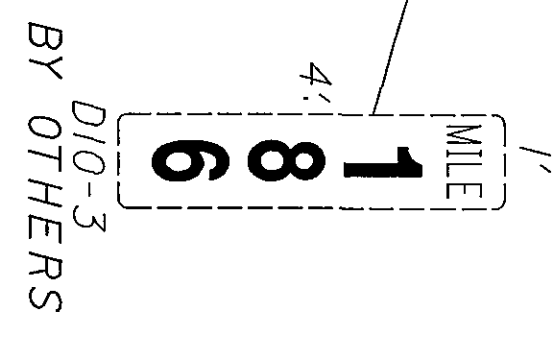
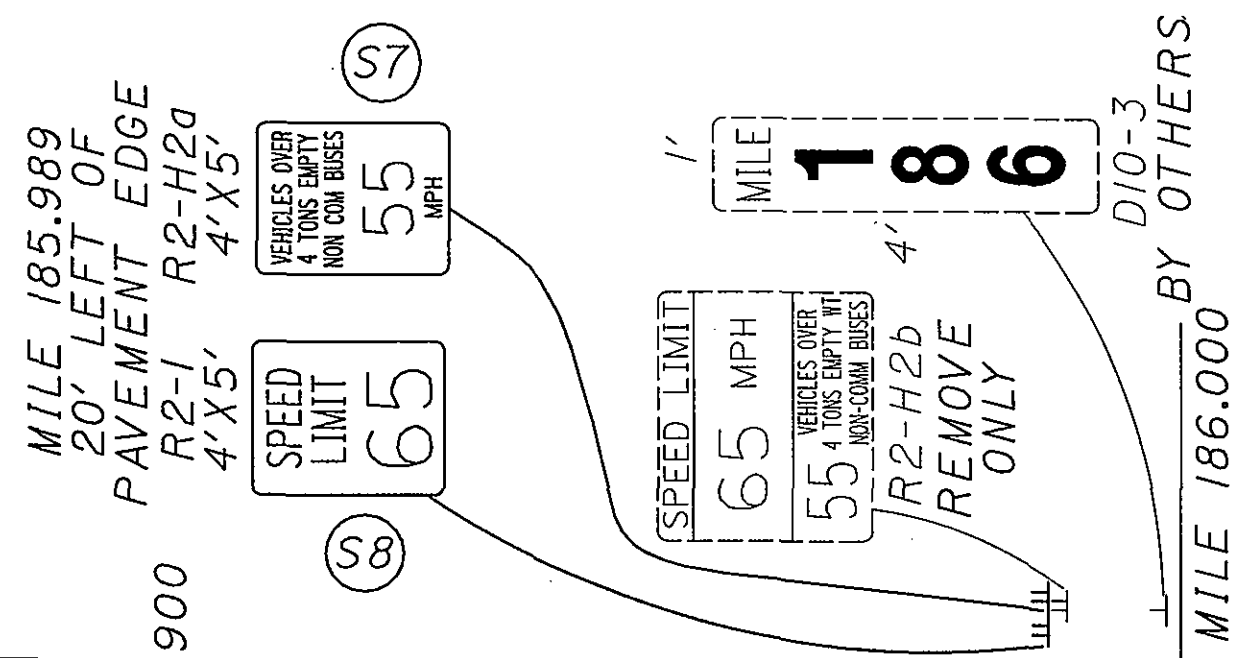
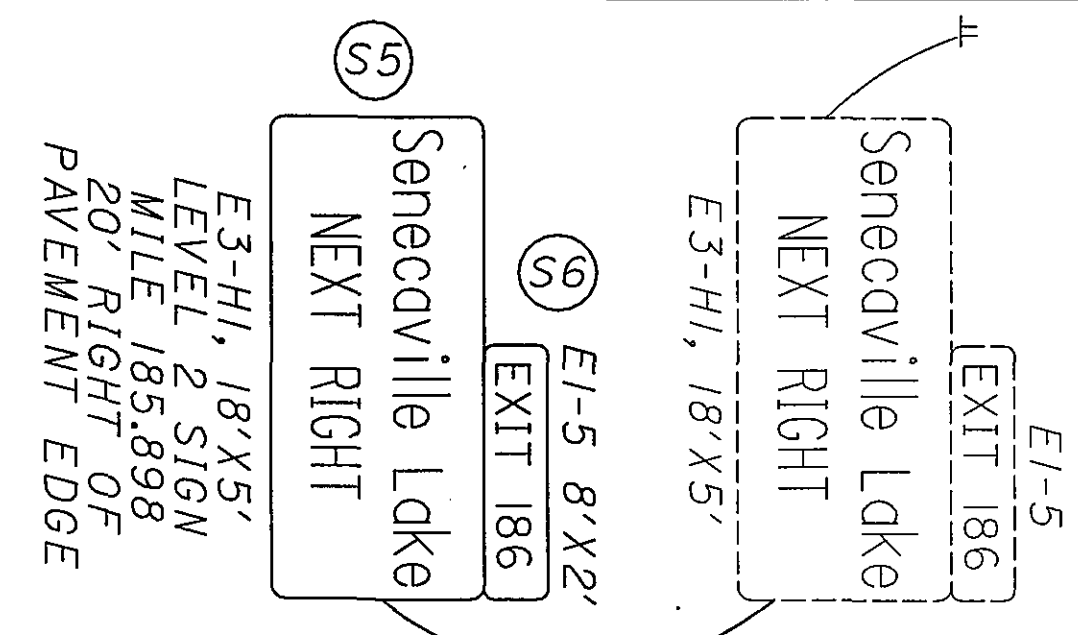
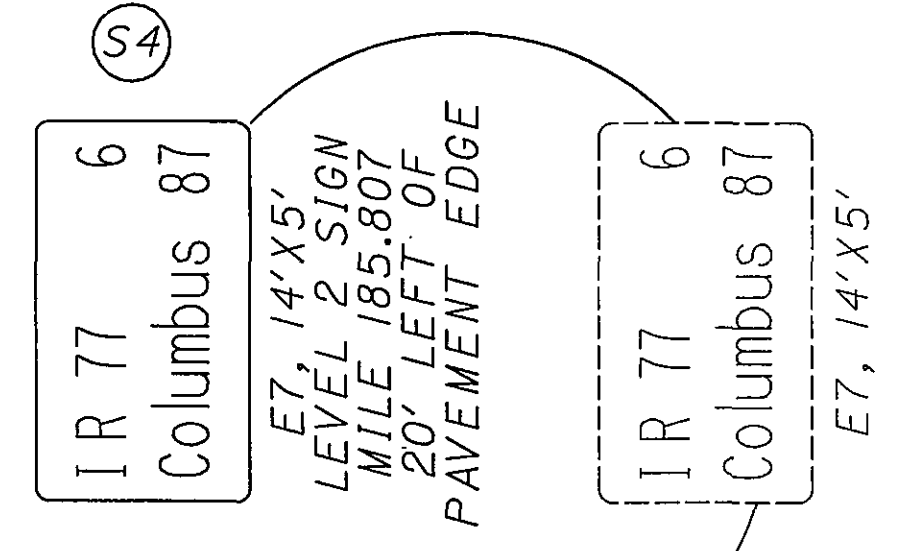
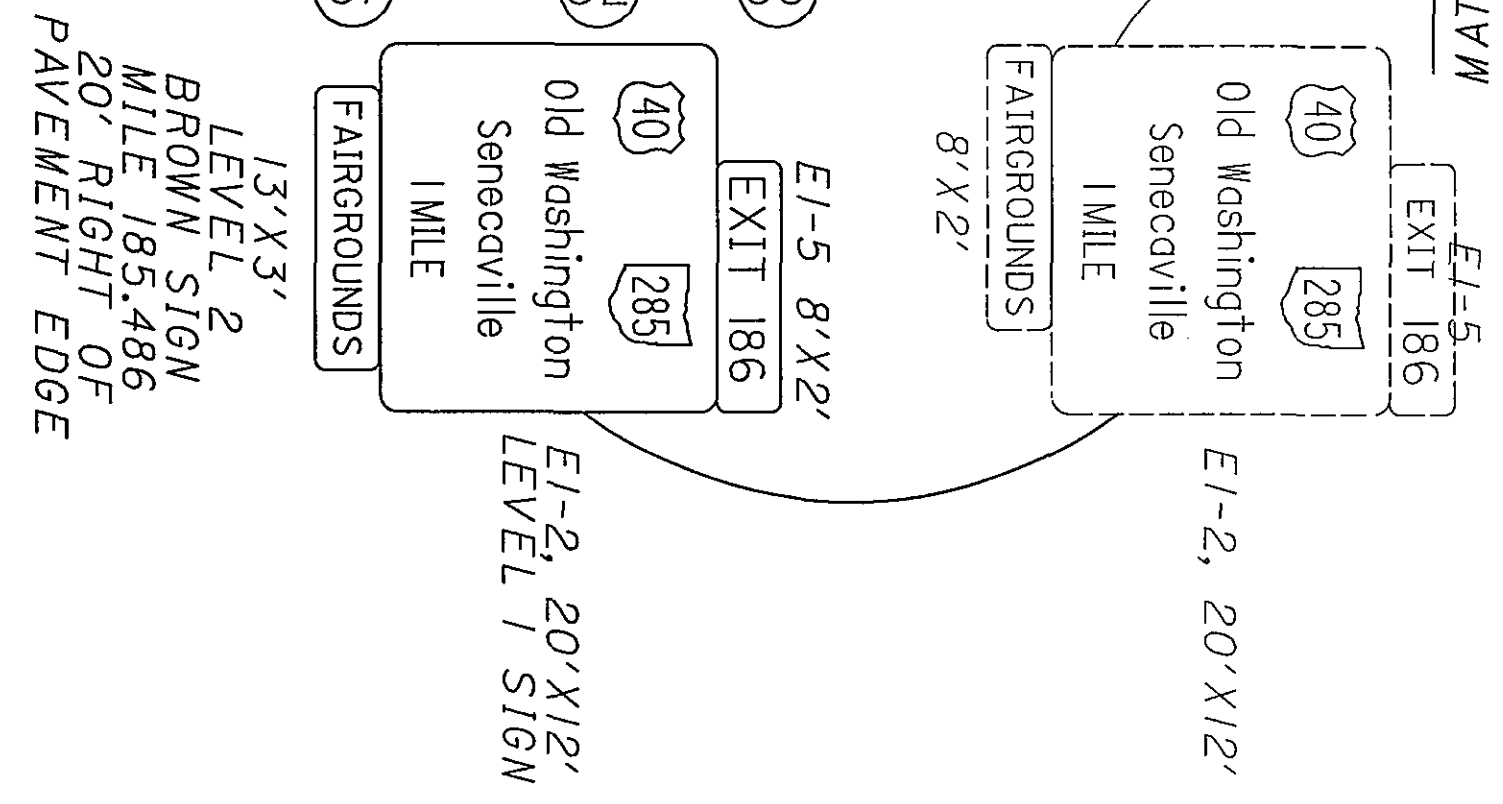
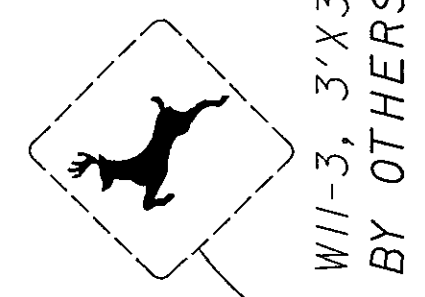

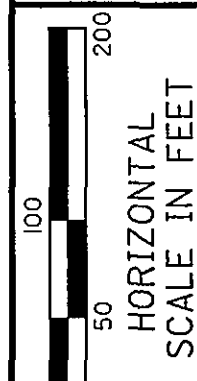
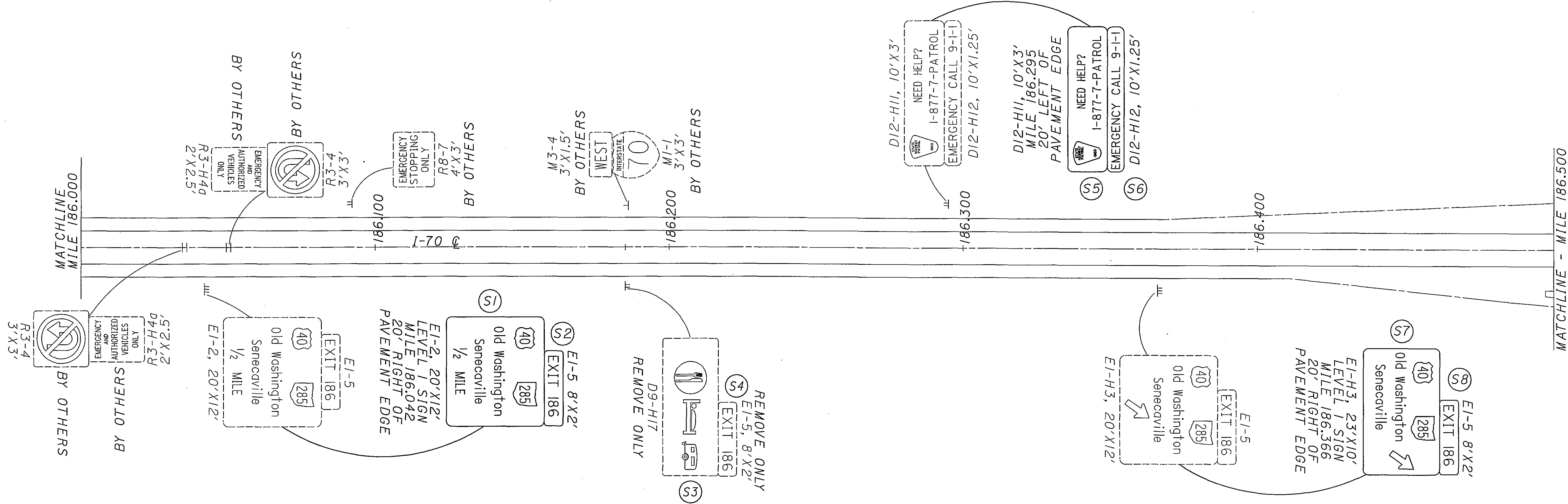

CALCULATED
 DAP
 CHECKED
 WEB

GUERNSEY COUNTY
MILE 186.000 TO MILE 186.500

D05 - SIGN - FY 2005

FOR QUANTITIES, SEE SHEET 156



HORIZONTAL SCALE IN FEET
0 100 200

CALCULATED DAP CHECKED WEB

GUERNSEY COUNTY SR 285 INTERCHANGE

D05 - SIGN - FY2005

121
166

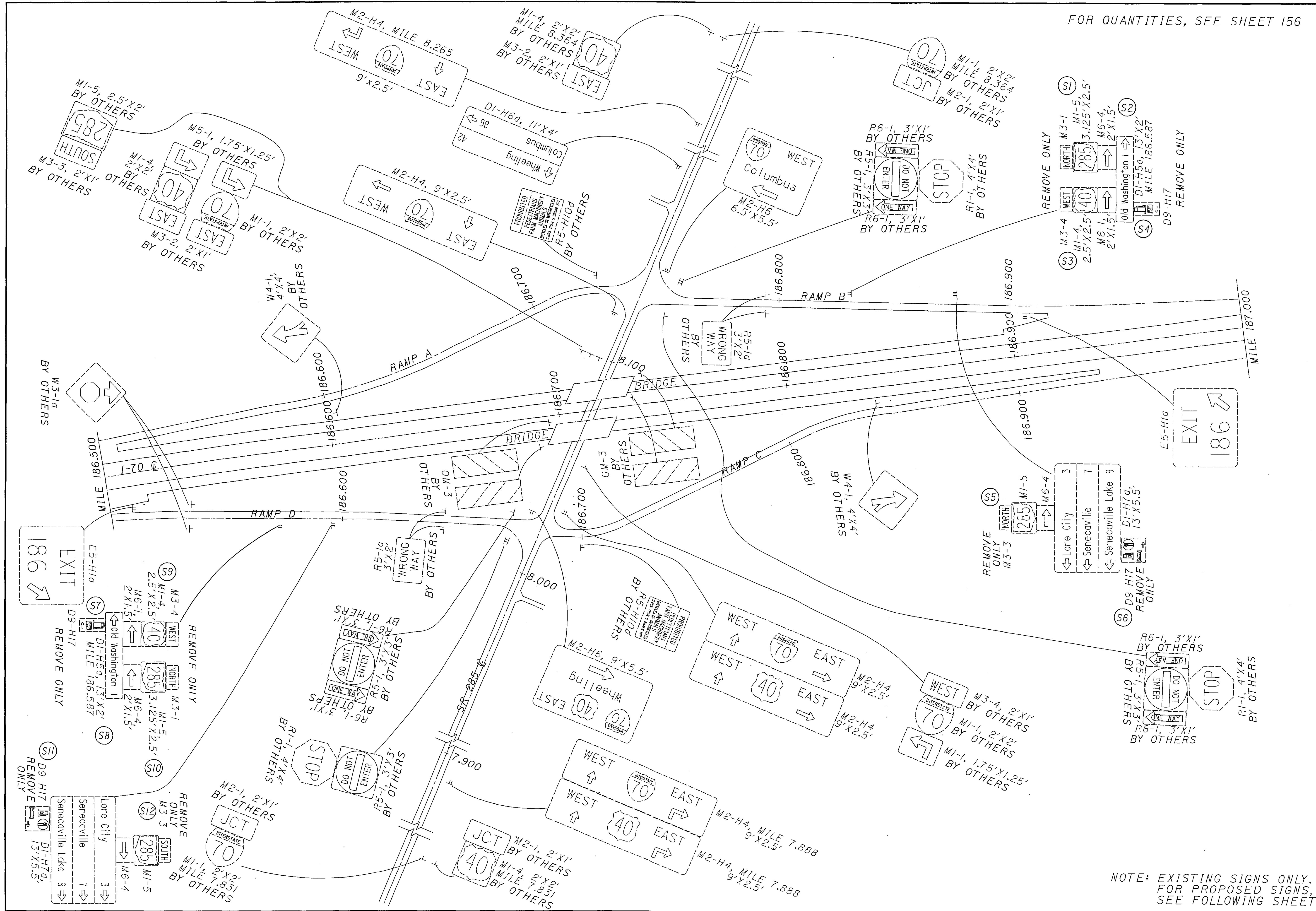

NOTE: EXISTING SIGNS ONLY.
FOR PROPOSED SIGNS,
SEE FOLLOWING SHEET.

08/13/2004 03:54:41 PM
m:\p\022150522 sign inventory\project plans\plan\signsheets\tpl16170.dgn

08/13/2004
 03:54:41 PM
 m:\p\0221505\22 sign inventory\project plans\plansheets\tbl\IT70.dgn

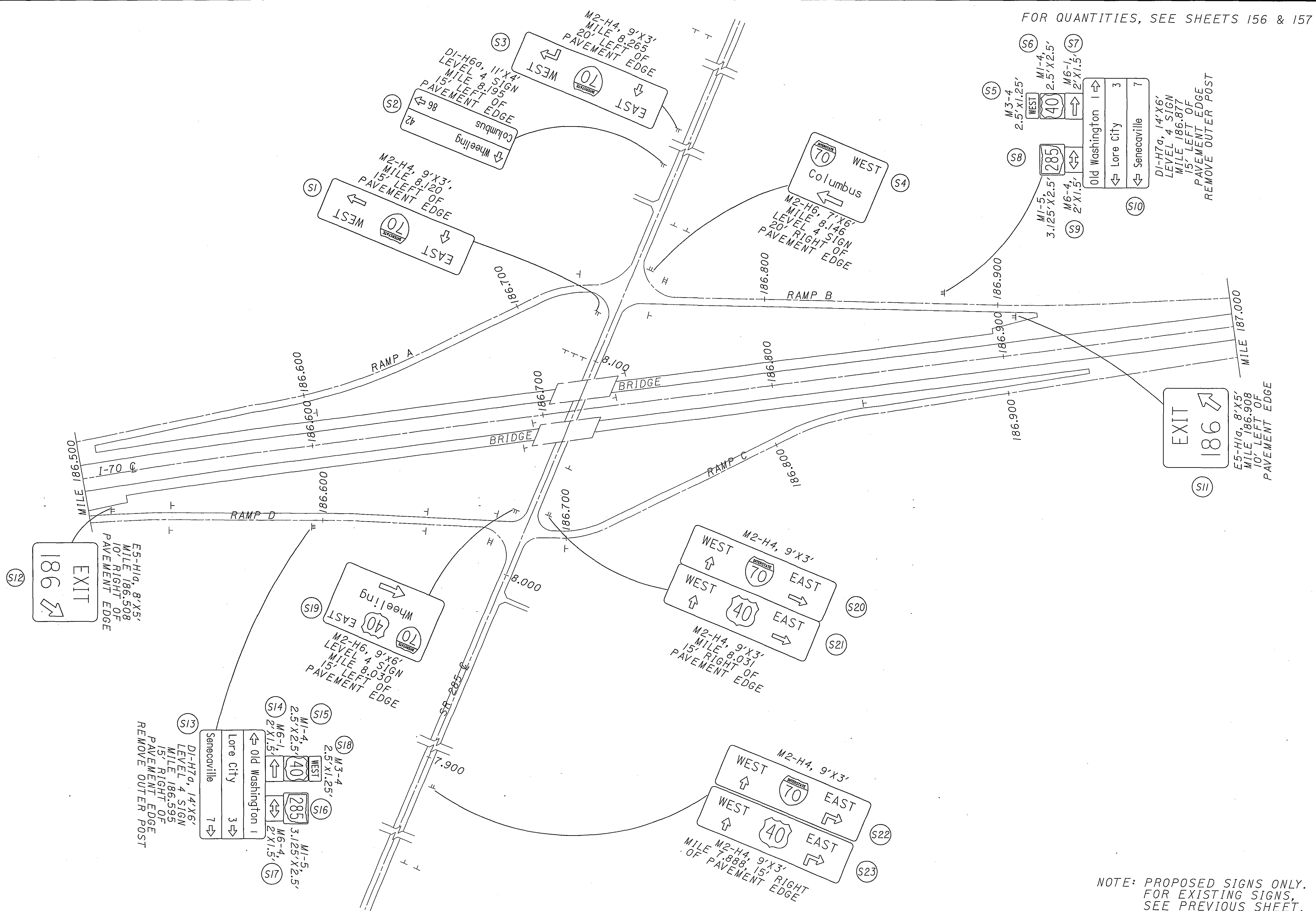

FOR QUANTITIES, SEE SHEETS 156 & 157

CALCULATED
 DAP
 CHECKED
 WEB

0 100 200
 HORIZONTAL
 SCALE IN FEET

**GUERNSEY COUNTY
 SR 285 INTERCHANGE**

D05-SIGN-FY2005

NOTE: PROPOSED SIGNS ONLY.
 FOR EXISTING SIGNS,
 SEE PREVIOUS SHEET.

EXIT 186
 E5-H1d, 8'X5'
 MILE 186.508
 10' RIGHT OF
 PAVEMENT EDGE

EXIT 186
 E5-H1d, 8'X5'
 MILE 186.908
 10' LEFT OF
 PAVEMENT EDGE

M3-4 2.5'X1.25'
 WEST 40
 M1-4 2.5'X2.5'
 M6-1/2 2'X1.5'
 M6-4 2'X1.5'
 M1-5 3.125'X2.5'
 M6-4 2'X1.5'

Old Washington 1
 Lore City 3
 Senecaville 7

DI-H7a, 14'X6'
 LEVEL 4 SIGN
 MILE 186.877
 15' LEFT OF
 PAVEMENT EDGE
 REMOVE OUTER POST

Wheeling
 EAST 40
 EAST 70
 M2-H6, 9'X6'
 LEVEL 4 SIGN
 MILE 8.030
 15' LEFT OF
 PAVEMENT EDGE

WEST 70 EAST
 WEST 40 EAST
 M2-H4, 9'X3'
 MILE 8.031
 15' RIGHT OF
 PAVEMENT EDGE

WEST 70 EAST
 WEST 40 EAST
 M2-H4, 9'X3'
 MILE 7.888, 15' RIGHT
 OF PAVEMENT EDGE

DI-H6a, 11'X4'
 LEVEL 4 SIGN
 MILE 8.195
 15' LEFT OF
 PAVEMENT EDGE
 Columbus
 WEST 70 EAST
 M2-H4, 9'X3'
 MILE 8.265
 20' LEFT OF
 PAVEMENT EDGE

WEST 70 EAST
 M2-H4, 9'X3'
 MILE 8.120
 15' LEFT OF
 PAVEMENT EDGE

WEST 70
 Columbus
 M2-H6, 7'X6'
 LEVEL 4 SIGN
 MILE 8.146
 20' RIGHT OF
 PAVEMENT EDGE

DI-H7a, 14'X6'
 LEVEL 4 SIGN
 MILE 186.595
 15' RIGHT OF
 PAVEMENT EDGE
 REMOVE OUTER POST

Senecaville
 Lore City
 Old Washington 1
 M3-4 2.5'X1.25'
 WEST 40
 M1-4 2.5'X2.5'
 M6-1/2 2'X1.5'
 M6-4 2'X1.5'
 M1-5 3.125'X2.5'

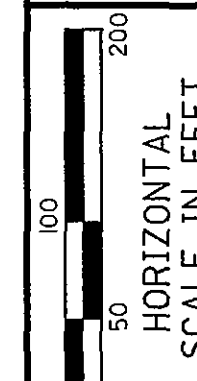
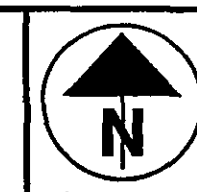

CALCULATED
DAP
CHECKED
WEB

**GUERNSEY COUNTY
MILE 188.000 TO MILE 189.000**

D05-SIGN-FY2005

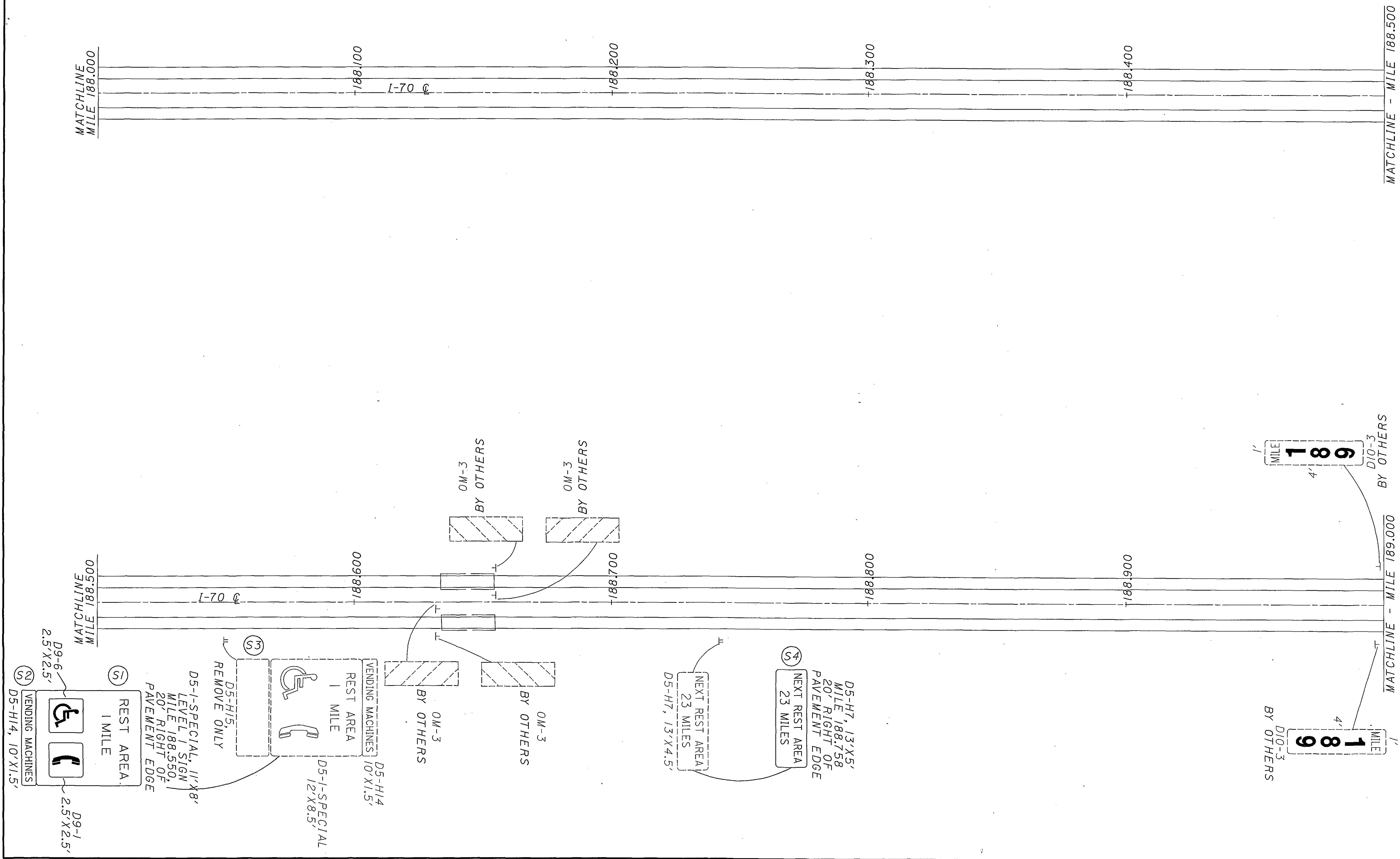

08/13/2004
08:54:41 AM
m:\p\p\0221\50522 sign_inventory\project_plans\plansheets\tp15170.dgn

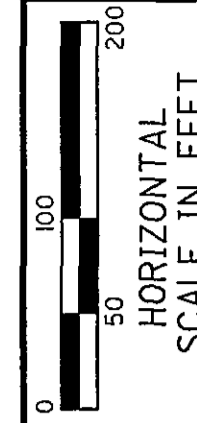
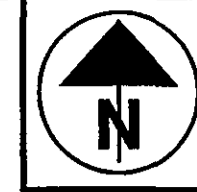

CALCULATED	DAP	CHECKED	WEB
------------	-----	---------	-----

GUERNSEY COUNTY
MILE 189.000 TO MILE 190.000

D05-SIGN-FY2005

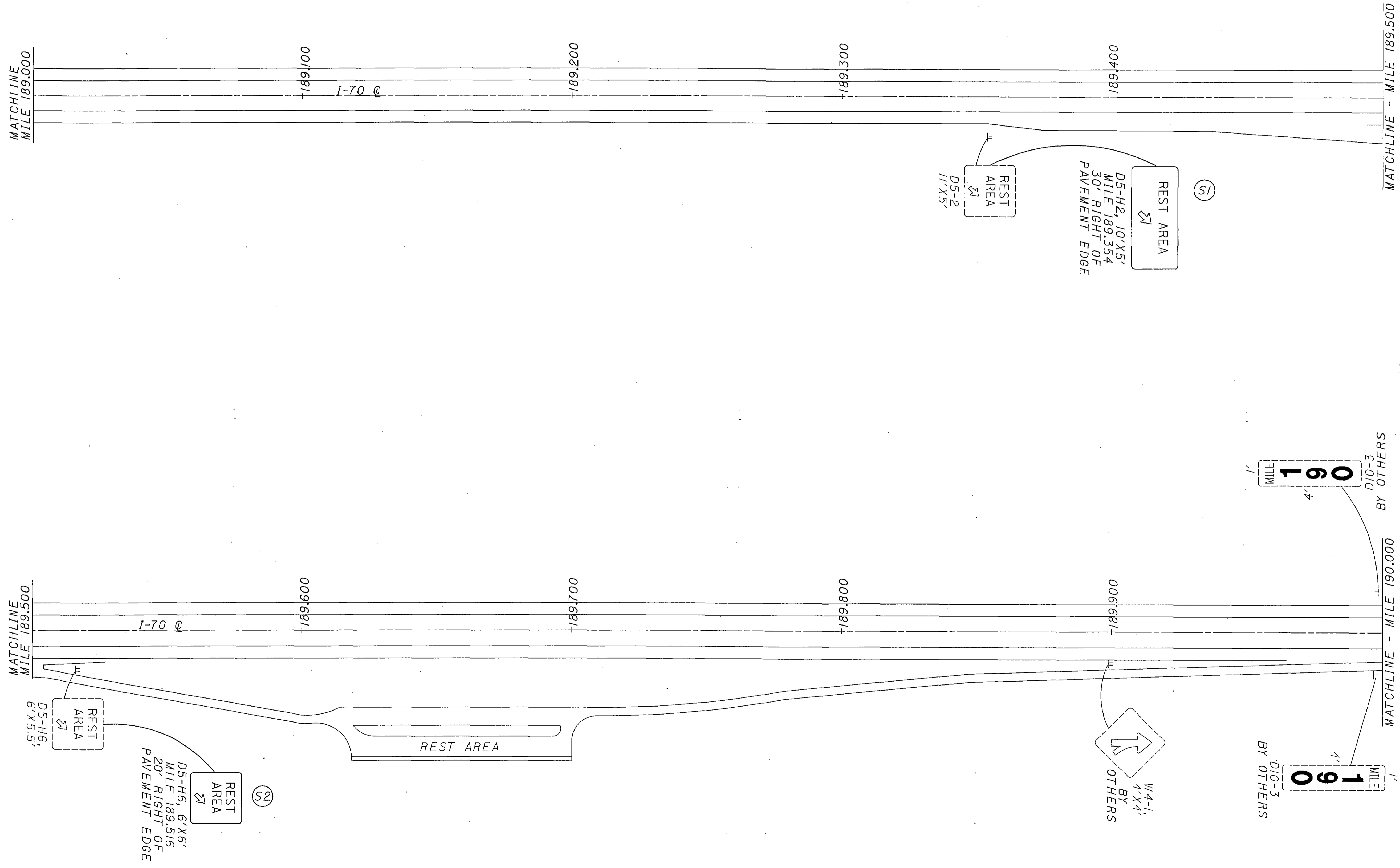

MATCHLINE - MILE 190.000

MATCHLINE - MILE 190.500

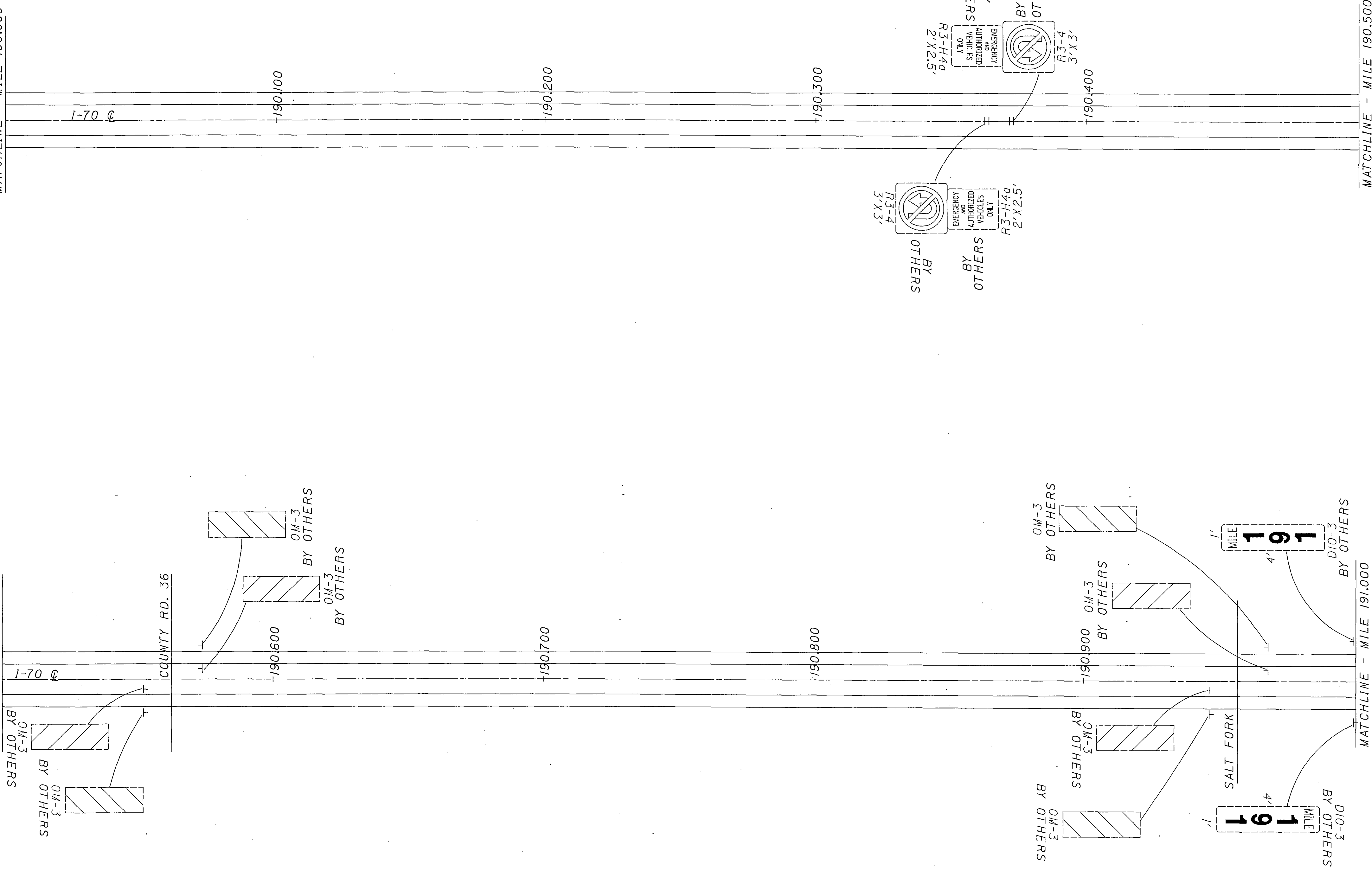

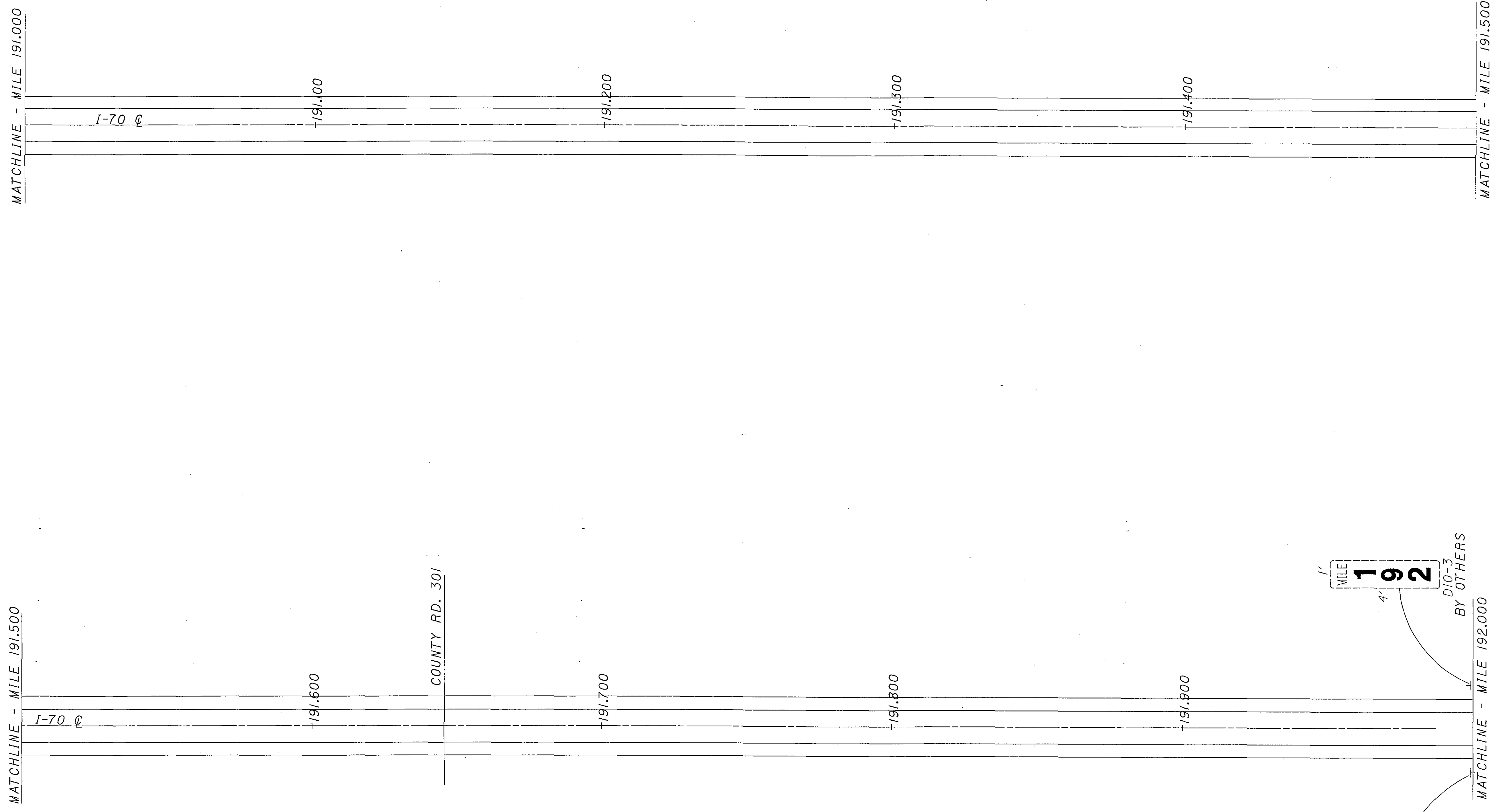

MATCHLINE - MILE 192.500

MATCHLINE - MILE 192.000

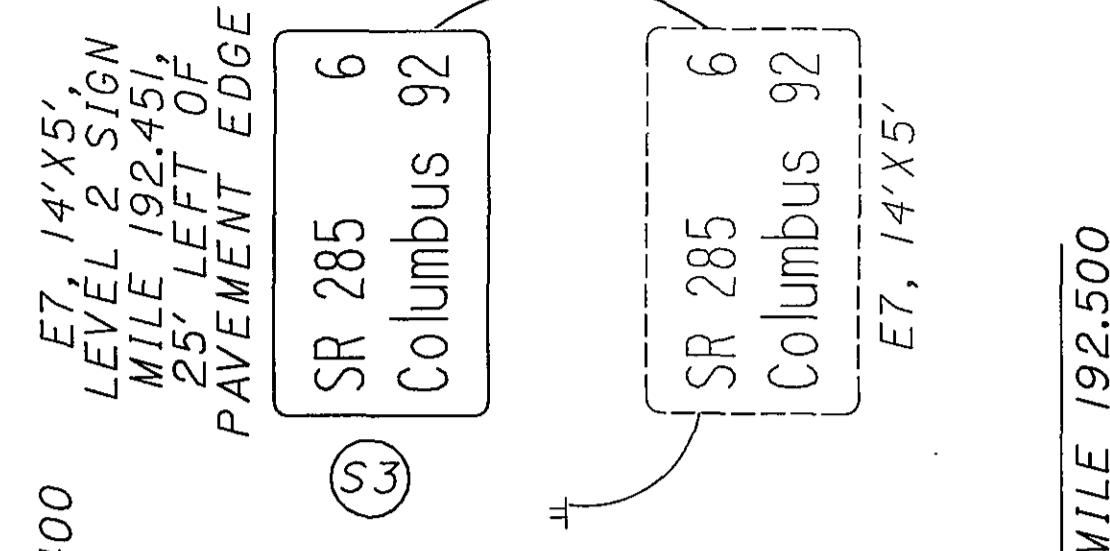
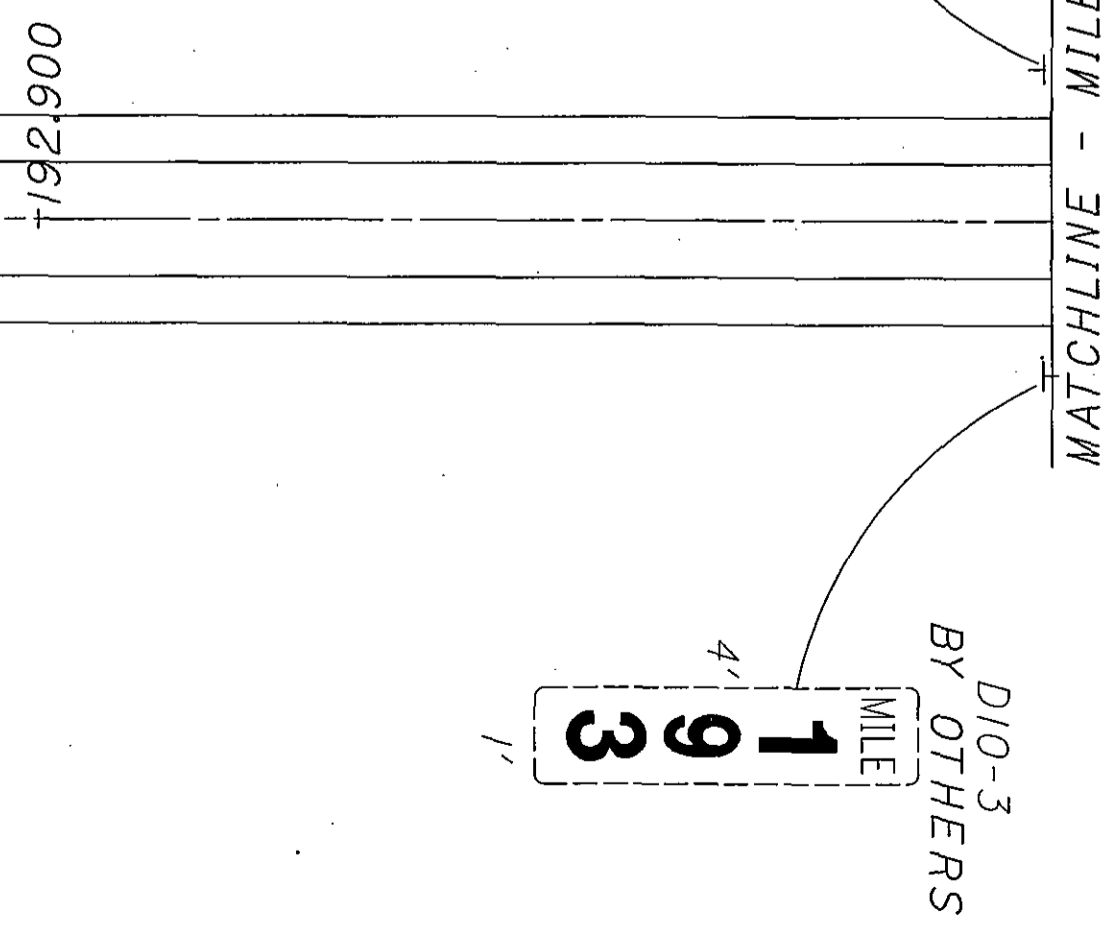
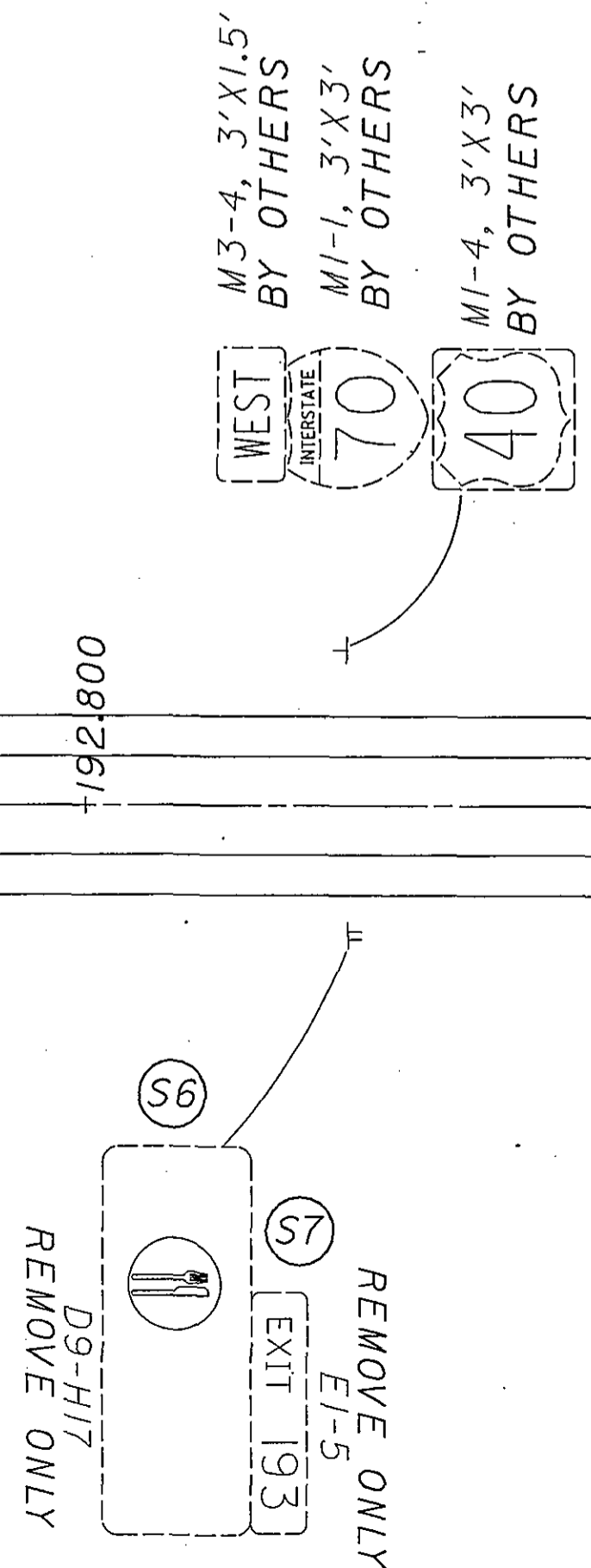
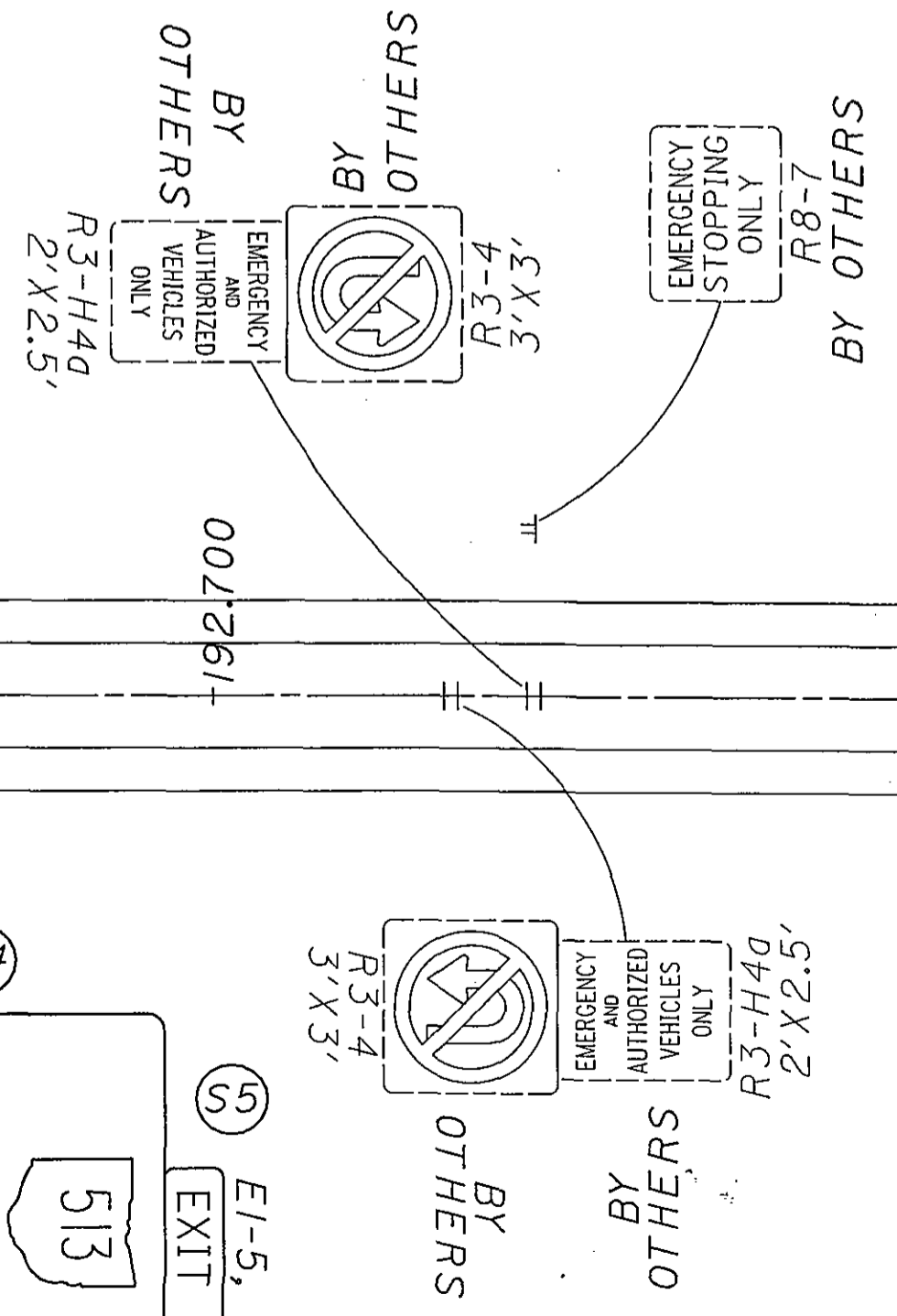
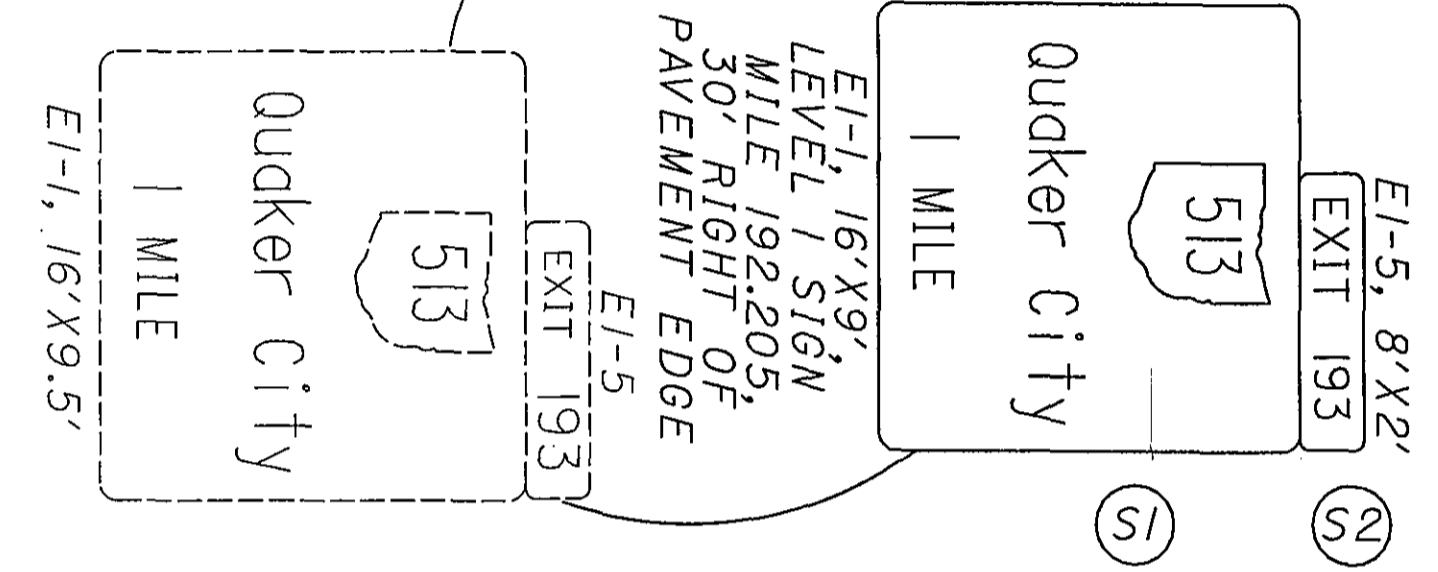
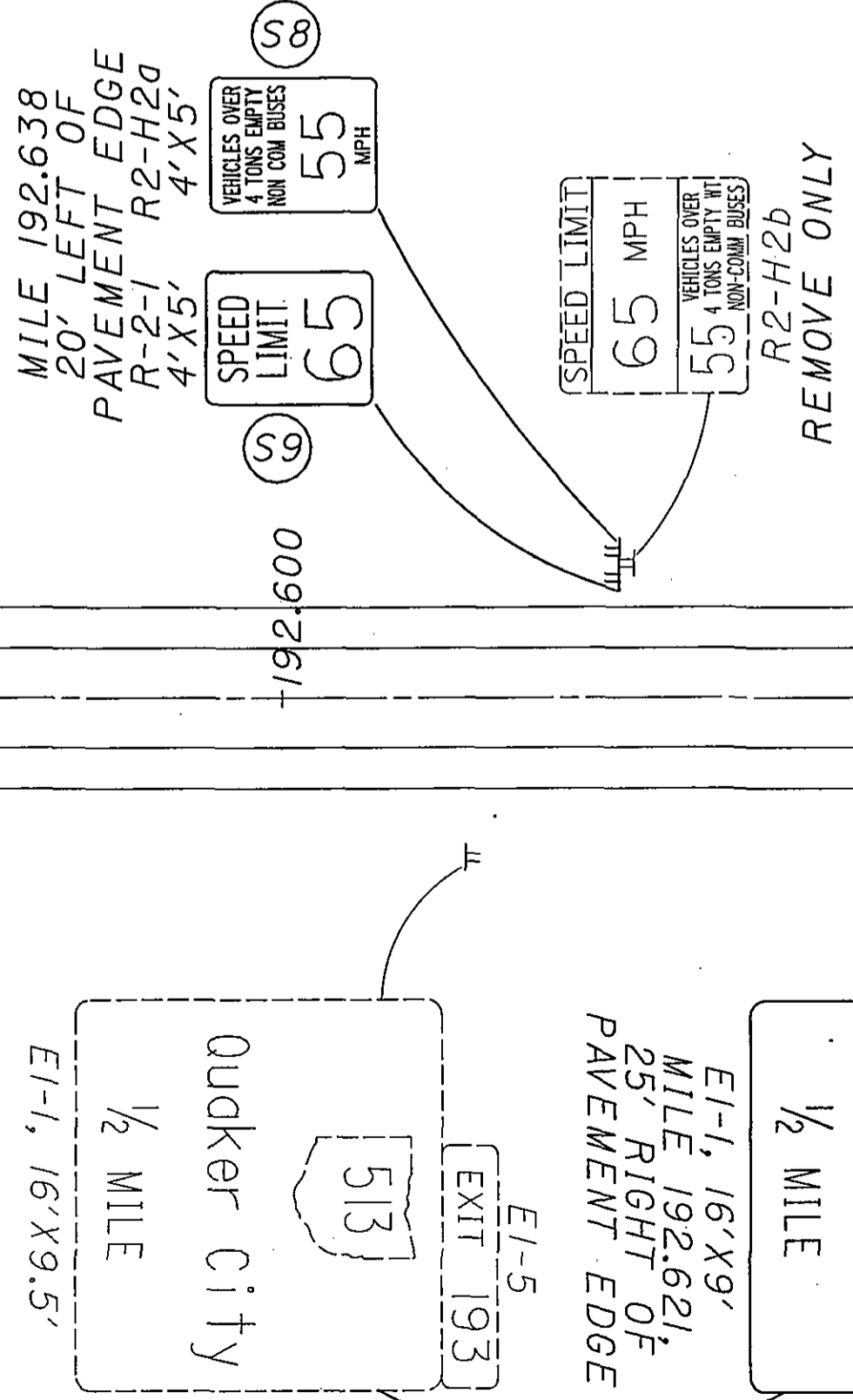
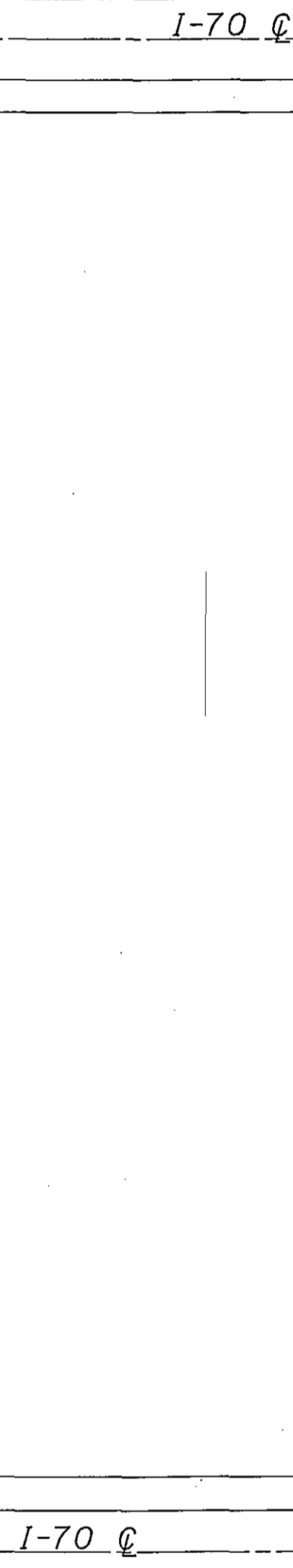

MATCHLINE - MILE 192.500

FOR QUANTITIES, SEE SHEET 157

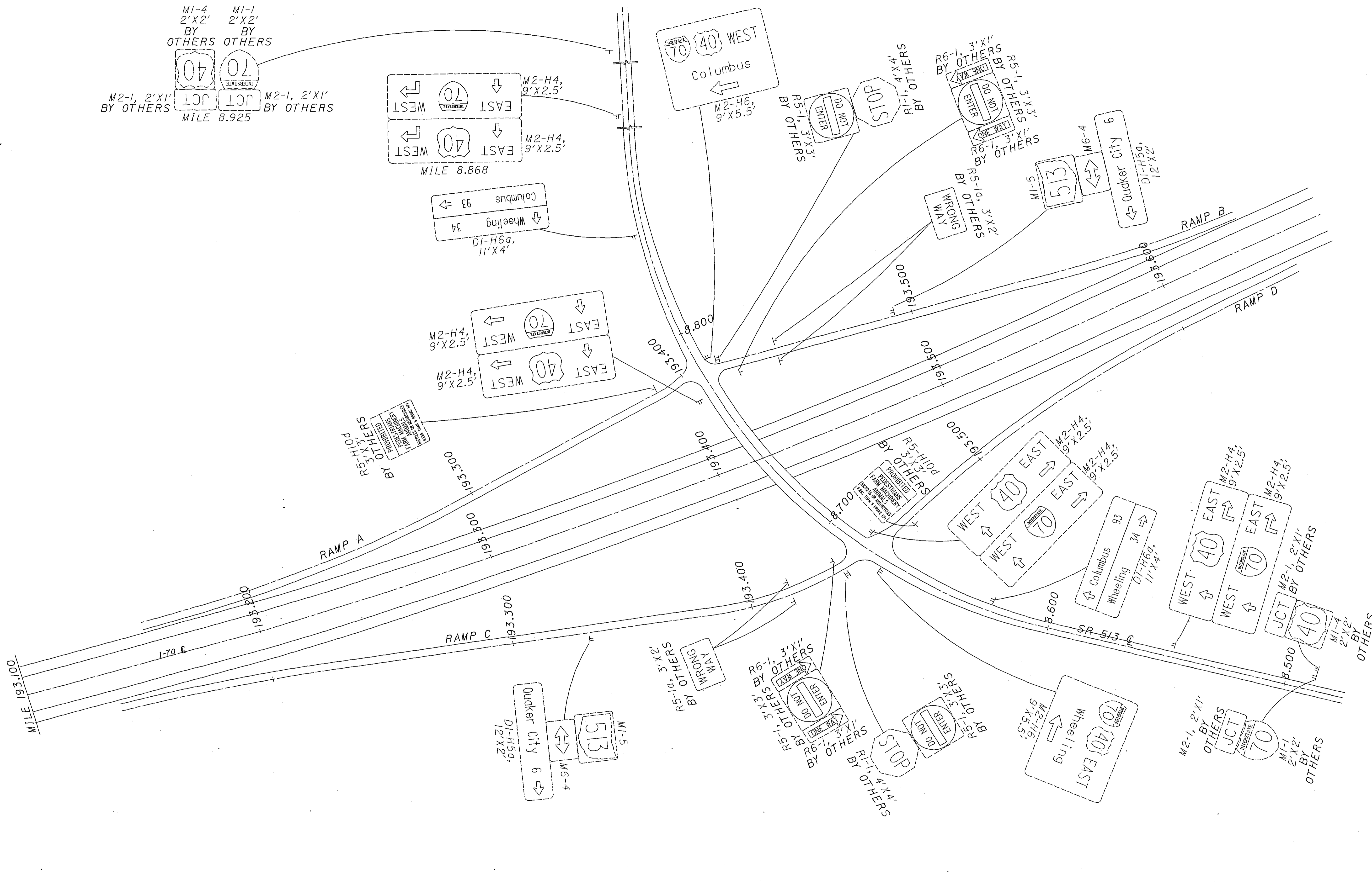

NOTE: EXISTING SIGNS ONLY.
FOR PROPOSED SIGNS,
SEE FOLLOWING SHEET.

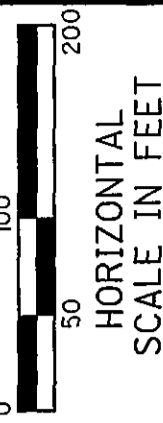

 HORIZONTAL SCALE IN FEET
 CALCULATED DCB CHECKED WEB

**GUERNSEY COUNTY
SR 513 INTERCHANGE**

D05 - SIGN - FY 2005



CALCULATED DCB CHECKED WEB

GUERNSEY COUNTY
SR 513 INTERCHANGE

D05-SIGN-FY2005

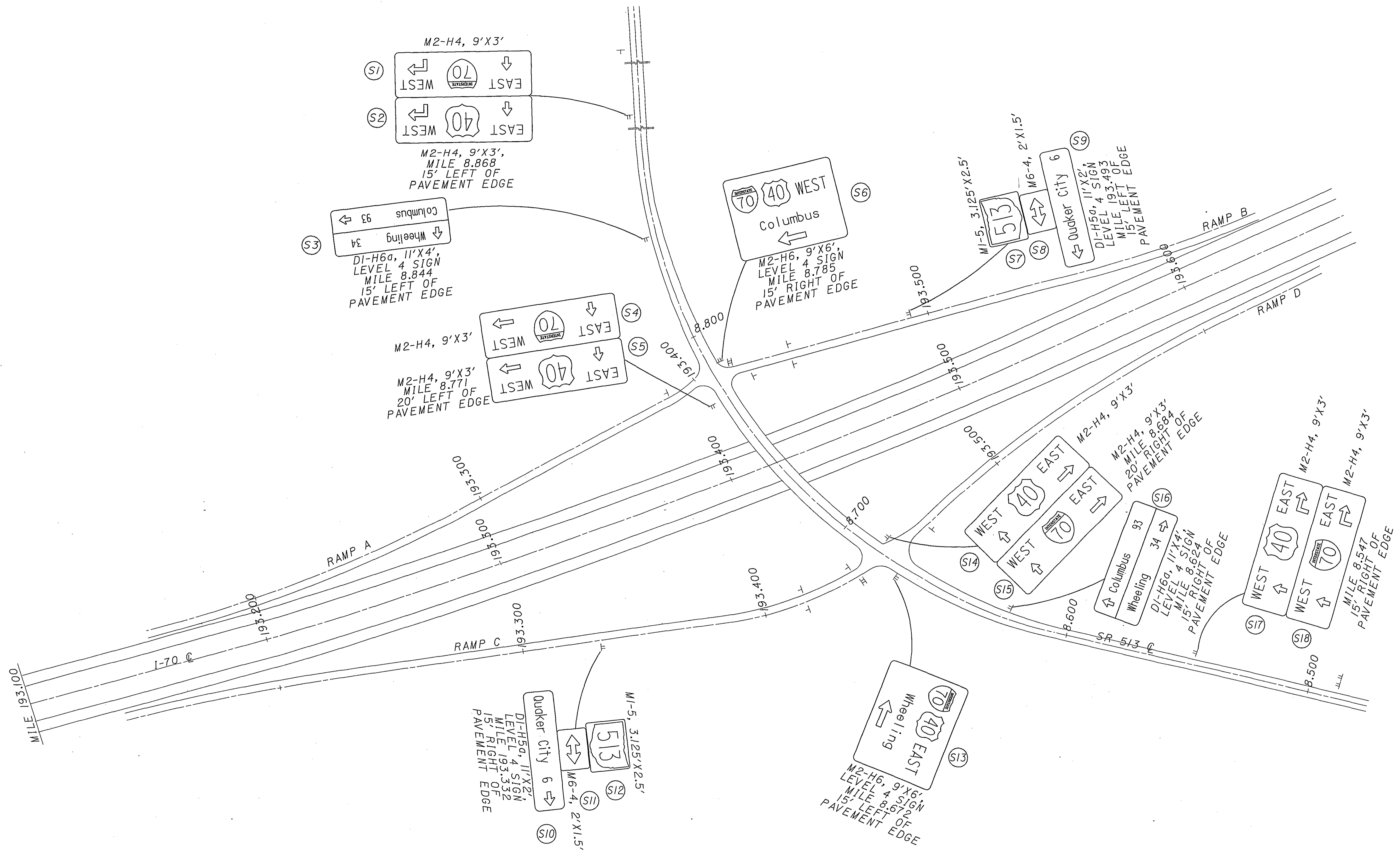

NOTE: PROPOSED SIGNS ONLY.
FOR EXISTING SIGNS,
SEE PREVIOUS SHEET.

08/13/2004 03:54:43 PM m:\proj\0221\505\22 sign inventory\project plans\plansheets\p126170.dgn

MATCHLINE - MILE 195.500

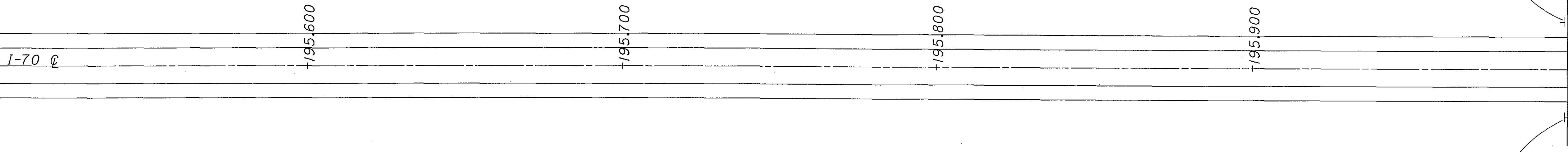

MATCHLINE - MILE 195.000

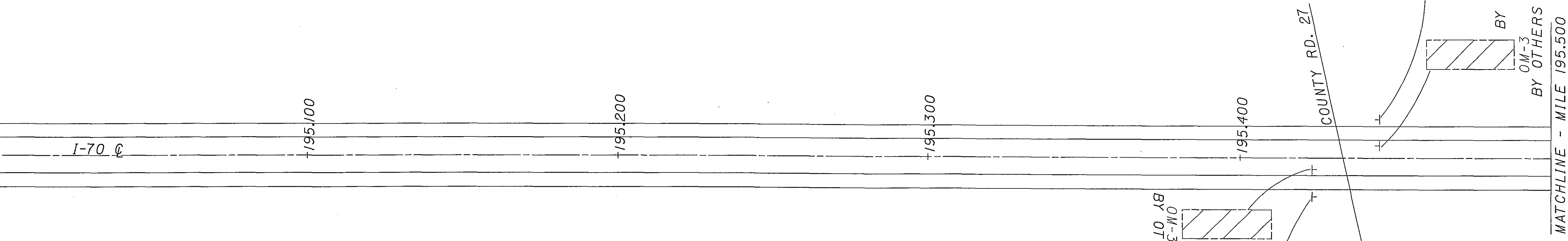

MATCHLINE - MILE 196.500

I-70

+196.600

+196.700

+196.800

+196.900

MATCHLINE - MILE 197.000

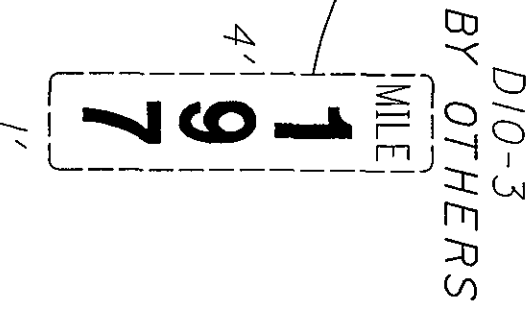

MATCHLINE - MILE 196.000

I-70

+196.100

+196.200

+196.300

+196.400

MATCHLINE - MILE 196.500

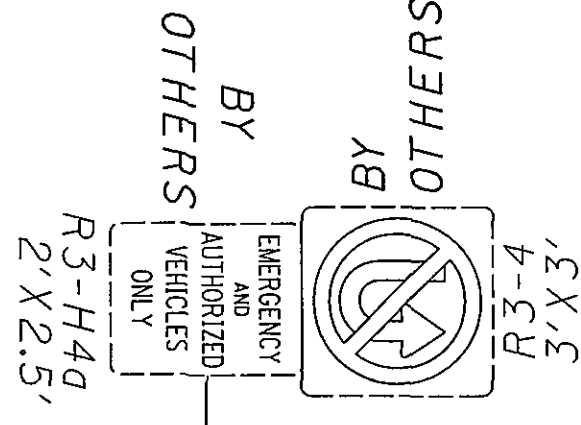
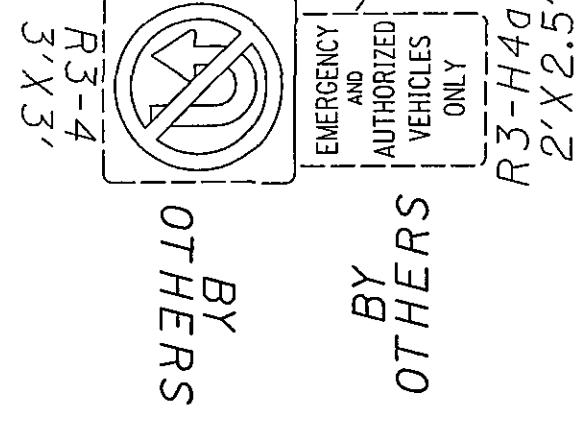

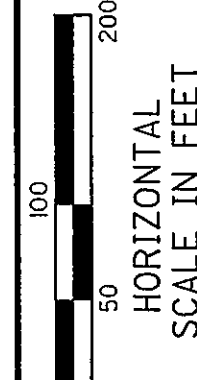

CALCULATED
DCB
CHECKED
WEB

GUERNSEY COUNTY
MILE 198.000 TO MILE 198.633

D05 - SIGN - FY2005

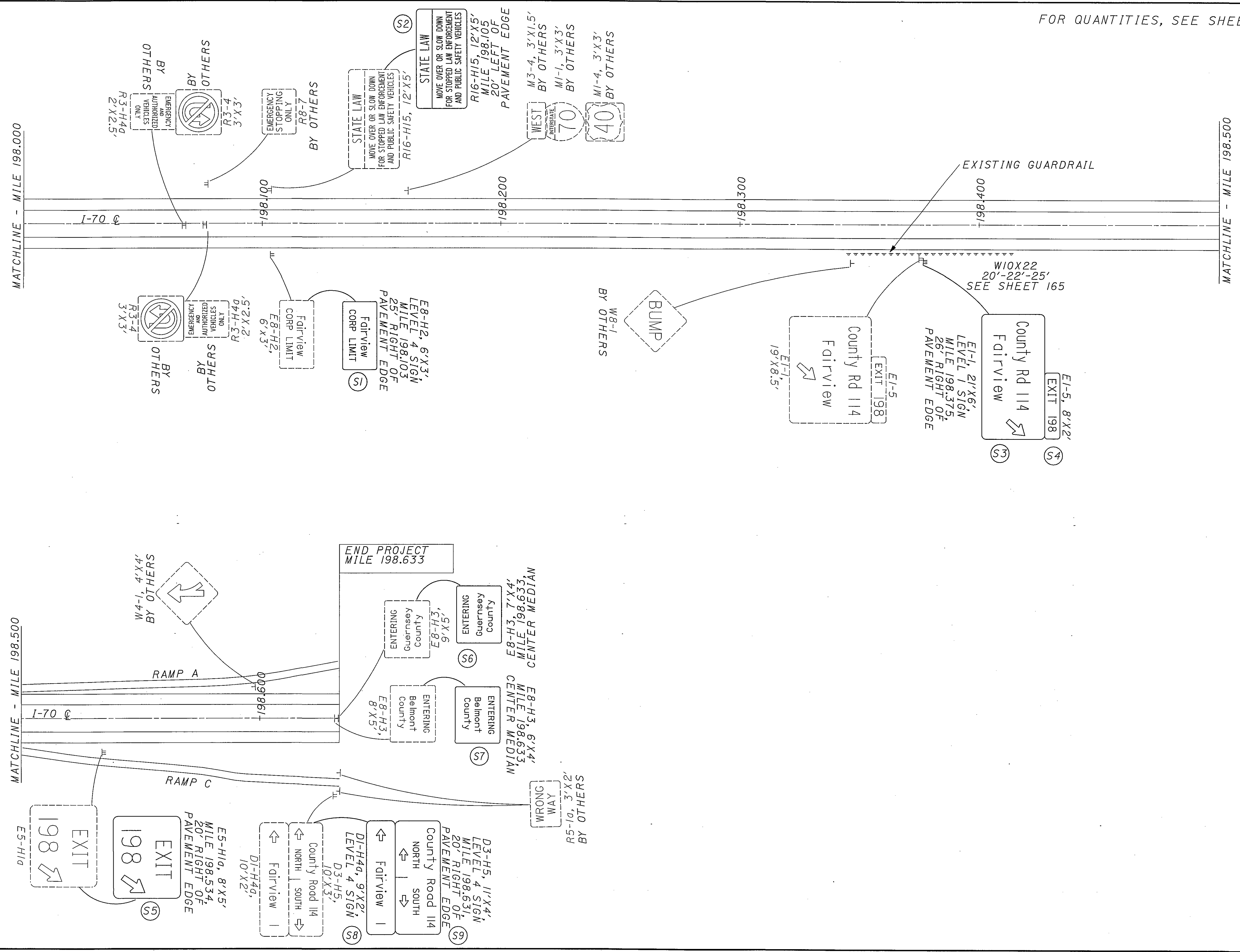

08/13/2004
03:54:44 PM
m:\proj\022\1505\22 sign inventory\project plans\plansheets\1p131170.dgn

08/25/2004 03:00:58 PM M:\p\022\1505\22 Sign Inventory\project plans\sheet\15001170.dgn

SHEET NO.	REFERENCE NO.	LOCATION	STATION	SIDE	CODE	SIZE (FEET)	630	630	630	630	630	630	630	630	630	630	630	630	631	631	631	630		
							SIGN ATTACHEMENT ASSEMBLY EACH	GROUND MOUNTED SUPPORT, W12X30 BEAM FT.	BREAKAWAY BEAM CONNECTION EACH	SIGN, FLAT SHEET SQ. FT.	SIGN, GROUND MOUNTED EXTRUSHEET SQ. FT.	SIGN, OVERHEAD EXTRUSHEET SQ. FT.	GROUND MOUNTED BEAM SUPPORT FOUNDATION EACH	GROUND MOUNTED SUPPORT NO. 4 POST FT.	REMOVAL OF GROUND MOUNTED SIGN AND DISPOSAL EACH	REMOVAL OF GROUND MOUNTED MAJOR SIGN AND DISPOSAL EACH	REMOVAL OF GROUND MOUNTED BEAM SUPPORT AND DISPOSAL EACH	REMOVAL OF OVERHEAD MOUNTED SIGN AND DISPOSAL EACH	SIGNING, MISC.: GROUND MOUNTED SUPPORT EACH	REMOVAL OF LUMINAIRE AND DISPOSAL EACH	REMOVAL OF BALLAST AND DISPOSAL EACH	REMOVAL OF SIGN SERVICE AND DISPOSAL, AS PER PLAN EACH	SIGNING, MISC.: CHECK TORQUE EACH	
6	S1	I-70	111.000	℄	E8-H3	6'X4'					24						1						1	
	S2	I-70	111.000	℄	E8-H3	6'X4'					24						1							
	S3	I-70	111.132	LT	E1-5	8'X2'							16				1							
	S4	I-70	111.132	LT	E1-2	17'X8'	1						136				1		2	2	1			
	S5	I-70	111.131	RT	E1-1	17'X12'	1						204				1		2	2	1			
	S6	I-70	111.131	RT	E1-5	12'X2'							24				1							
	S7	I-70	111.240	LT	E3-H2	18'X9'					162						1						1	
	S8	I-70	111.680	LT	E8-H2	7'X3'					21					1							1	
	S9	I-70	111.810	LT	E1-5	9'X2'					18					1								
	S10	I-70	111.810	LT	-	23'X8'					184													
	S11	I-70	111.828	RT	E1-1	16'X9'	1						144				1		2	2	1			
	S12	I-70	111.828	RT	E1-5	9'X2'							18				1							
	S13	I-70	111.894	RT	E8-H2	8'X3'					24					1							1	
	S14	I-70	111.915	RT	E1-1	15'X12'	1						180				1		2	2	1			
	S15	I-70	111.915	RT	E1-5	9'X2'							18				1							
	S16	I-70	111.491	LT	R2-1	4'X5'			20							1								
	S17	I-70	111.491	LT	R2-H2a	4'X5'			20							1								
8	S1	SR 256	0.458	RT	M2-H6	10'X5'	1						50				1		2	2	1			
	S2	SR 256	0.338	RT	M2-H6	11'X5'	1						55				1		2	2	1			
	S3	SR 256	0.262	RT	M2-H5	9'X4'					36					1								
	S4	SR 256	0.403	LT	M2-H6	9'X7'					63					1							1	
	S5	I-70 RAMP B	112.307	LT	M1-5	3.75'X3'			11.3							1								
	S6	I-70 RAMP B	112.307	LT	M6-4	2.5'X2'			5							1								
	S7	I-70 RAMP B	112.307	LT	D1-H6a	12'X4'					48						1						1	
	S8	I-70	112.392	LT	E5-H1a	8'X5'					40						1							
	S9	I-70	112.445	LT	E8-H2	8'X3'					24					1							1	
	S10	I-70	112.045	RT	E5-H1a	9'X5'					45						1							
	S11	SR 256	0.485	LT	M2-H6	11'X5'	1						55				1		2	2	1			
	S12	SR 256	0.582	LT	M2-H6	8'X7'	1						56				1		2	2	1			
	S13	SR 256	0.582	LT	M2-H6	8'X7'	1						56				1		2	2	1			
	S14	I-70	112.273	RT	E5-H1a	9'X5'					45						1							
	S15	SR 256	0.677	LT	M2-H5	9'X4'					36													
TOTALS CARRIED TO LAST SHEET OF SUBSUMMARY							9			56.3	794	1012				10	9		13	3	18	18	9	7

SIGNING SUBSUMMARY

D05 - SIGN - FY 2005

CALCULATED
JAM
CHECKED
WEB

137
166

08/25/2004
03:08:17 PM
M:\pro\022\1505\22 Sign Inventory\project plans\sheet\ts006170.dgn

SHEET NO.	REFERENCE NO.	LOCATION	STATION	SIDE	CODE	SIZE (FEET)	630	630	630	630	630	630	630	630	630	630	630	630	630	630	630	630	630	
							SIGN ATTACHEMENT ASSEMBLY EACH	GROUND MOUNTED SUPPORT, W12X30 BEAM FT.	BREAKAWAY BEAM CONNECTION EACH	SIGN, FLAT SHEET SQ. FT.	SIGN, GROUND MOUNTED EXTRUSHEET SQ. FT.	SIGN, OVERHEAD EXTRUSHEET SQ. FT.	GROUND MOUNTED BEAM SUPPORT FOUNDATION EACH	GROUND MOUNTED SUPPORT NO. 4 POST FT.	REMOVAL OF GROUND MOUNTED SIGN AND DISPOSAL EACH	REMOVAL OF GROUND MOUNTED SIGN AND DISPOSAL EACH	REMOVAL OF GROUND MOUNTED BEAM SUPPORT AND DISPOSAL EACH	REMOVAL OF OVERHEAD MOUNTED SIGN AND DISPOSAL EACH	SIGNING, MISC.: GROUND MOUNTED SUPPORT EACH	REMOVAL OF LUMINAIRE AND DISPOSAL EACH	REMOVAL OF BALLAST AND DISPOSAL EACH	REMOVAL OF SIGN SERVICE AND DISPOSAL, AS PER PLAN EACH	SIGNING, MISC.: CHECK TORQUE EACH	
34	S1	I-70	128.910	LT	E5-H1a	9'X5'				45														
	S2	I-70 NE LOOP	4.438	RT	M2-H6	10'X5'	1				50													
	S3	I-70	128.999	LT	E1-5	9'X2'					18													
	S4	I-70	128.999	LT	E1-H3	8'X12'	1				96													
	S5	I-70	128.987	RT	E1-H3	15'X8'	1				120													
	S6	I-70	128.987	RT	E1-5	9'X2'					18													
	S7	SR 79	4.328	LT	M2-H6	10'X5'	1				50													
	S8	I-70	129.068	RT	E5-H1a	9'X5'				45														
	S9	I-70	129.275	LT	E5-H1a	9'X5'				45														
	S10	I-70	129.279	LT	E1-5	9'X2'					18													
	S11	I-70	129.279	LT	E1-H3	14'X8'	1				112													
	S12	I-70	129.279	LT	E1-5	9'X2'					18													
	S13	I-70	129.279	LT	E1-1	18'X9'	1				162													
	S14	I-70	129.279	LT	W9-H4L	20'X7'	1				140													
35	S1	SR 79	4.092	RT	D1-H5a	14'X5'				70														
	S2	SR 79	4.092	RT	M6-3	2'X1.5'																		
	S3	SR 79	4.092	RT	M1-1	2.5'X2.5'				3														
	S4	SR 79	4.092	RT	M3-4	2.5'X1.25'				6.3														
	S5	SR 79	4.092	RT	M6-2	2'X1.5'				3														
	S6	SR 79	4.092	RT	M1-1	2.5'X2.5'				6.3														
	S7	SR 79	4.092	RT	M3-2	2.5'X1.25'				3.1														
	S8	SR 79	4.135	RT	M2-H6	9'X7'	1				63													
	S9	SR 79	4.135	RT	M2-H6	10'X5'	1				50													
	S10	SR 79	4.566	LT	M2-H6	10'X5'	1				50													
	S11	SR 79	4.566	LT	M2-H6	9'X7'	1				63													
	S12	SR 79	4.677	LT	M3-4	2.5'X1.25'				3.1														
	S13	SR 79	4.677	LT	M1-1	2.5'X2.5'				6.3														
	S14	SR 79	4.677	LT	M6-2	2'X1.5'				3														
	S15	SR 79	4.677	LT	M3-2	2.5'X1.25'				3.1														
	S16	SR 79	4.677	LT	M1-1	2.5'X2.5'				6.3														
	S17	SR 79	4.677	LT	M6-3	2'X1.5'				3														
	S18	SR 79	4.677	LT	D1-H5a	14'X5'				70														
36	S1	I-70	129.500	LT	E1-5	9'X2'				18														
	S2	I-70	129.500	LT	E1-1	12'X9'				108														
	S3	I-70	129.715	LT	E1-5	9'X2'				18														
	S4	I-70	129.715	LT	E3-H1	9'X5'				45														
	S5	I-70	129.640	RT	D5-I-SPECIAL	11'X8'				88														
	S6	I-70	129.790	RT	D5-H7	13'X5'				65														
37	S1	I-70	130.085	LT	E1-5	9'X2'				18														
	S2	I-70	130.085	LT	D5-H12a	10'X6'				60														
	S3	I-70	130.217	LT	E1-5	12'X2'					24													
	S4	I-70	130.217	LT	E1-1	18'X12'	1				216													
	S5	I-70	130.217	LT	W9-H5L	20'X7'	1				140													
	S6	I-70	130.388	RT	D5-H2	10'X5'				50														
	S7	I-70	130.630	LT	D5-H6	6'X6'				36														
	S8	I-70	130.550	RT	D5-H6	6'X6'				36														
	S9	I-70	130.861	LT	D5-H2	10'X5'				50														
TOTALS CARRIED TO LAST SHEET OF SUBSUMMARY							13			49.6	867	1408			17	12		18	3				5	

SIGNING SUBSUMMARY

D05-SIGN-FY2005

SHEET NO.	REFERENCE NO.	LOCATION	STATION	SIDE	A.P.P. - AS CODE	PER PLAN SIZE (FEET)	630	630	630	630	630				630	630		630	630	630	630	630		630			
							SIGNING, MISC.; GROUND MOUNTED SUPPORT FOR STORAGE	BREAKAWAY BEAM CONNECTION, A.P.P.	SIGN, FLAT SHEET	SIGN, GROUND MOUNTED EXTRUSHEET	SIGN, GROUND MOUNTED EXTRUSHEET, A.P.P.	REMOVAL OF GROUND MOUNTED SIGN AND DISPOSAL	REMOVAL OF GROUND MOUNTED MAJOR SIGN AND DISPOSAL	SIGN, FLAT SHEET, A.P.P.	SIGN, OVERHEAD EXTRUSHEET, A.P.P.	GROUND MOUNTED SUPPORT NO. 4 POST, A.P.P.	GROUND MOUNTED SUPPORT, WIOX22 BEAM, A.P.P.	SIGN ATTACHMENT ASSEMBLY, A.P.P.	SIGNING, MISC.; CHECK TORQUE	EACH	EACH	SO. FT.	SO. FT.	SO. FT.	EACH	EACH	SO. FT.
65	S12	I-70 RAMP A	152.420	RT	M6-4	2'X1.5'			3						1												
	S13	I-70 RAMP A	152.420	RT	M1-4	2.5'X2.5'			6.3						1												
	S14	US 40	9.425	RT	M2-H6	8'X7'				56						1											
	S15	US 40	9.468	LT	M2-H4	9'X3'				27																	
	S16	US 40	9.563	LT	D1-H6a	14'X5'				70																	1
	S17	US 40	9.639	LT	M2-H5	9'X4'				36																	
	S18	US 40	9.277	LT	M2-H6	9'X7'				63																	1
66	S1	I-70	152.704	LT	E1-5	8'X2'																					
	S2	I-70	152.704	LT	E1-H3	18'X8'			2																		26-22
	S3	I-70	153.000	RT	E1-1	16'X11'																					
	S4	I-70	153.000	RT	E1-5	8'X2'																					
	S5	I-70	153.060	LT	E1-5	8'X2'																					
	S6	I-70	153.060	LT	D9-H17	10'X2.5'																					
	S7	I-70	153.208	LT	E1-5	8'X2'																					
	S8	I-70	153.208	LT	E1-1	15'X10'																					
	S9	I-70	153.436	RT	E3-H2	11'X5'																					
	S10	I-70	153.436	RT	E1-5	8'X2'																					
67	S1	I-70	153.508	RT	D12-H17	11'X5'																					
	S2	I-70	153.508	RT	E1-5	8'X2'																					
	S3	I-70	153.528	LT	E1-5	8'X2'																					
	S4	I-70	153.528	LT	E1-1	15'X9'																					
	S5	I-70	153.528	LT	E2-1	12'X2'																					
	S6	I-70	153.603	RT	E3-H1	16'X11'																					
	S7	I-70	153.603	RT	E1-5	8'X2'																					
	S8	I-70	153.660	RT	E8-H2	6'X3'																					
	S9	I-70	153.660	RT	E8-H2	7'X3'																					
	S10	I-70	153.582	LT	R2-H2a	4'X5'																					
	S11	I-70	153.582	LT	R2-1	4'X5'																					
69	S1	I-70	153.774	LT	E8-H4	6'X3'																					
	S2	SR 60G	0.297	LT	M2-H6	9'X7'																					
	S3	SR 60G	0.297	LT	M2-H6	9'X7'																					
	S4	SR 60G	0.342	LT	M2-H4	9'X3'																					
	S5	I-70	154.089	LT	E5-H1a	9'X5'																					
	S6	I-70	153.829	RT	E1-1	15'X11'																					
	S7	I-70	153.829	RT	E1-5	8'X2'																					
	S8	I-70	153.829	RT	E1-2	11'X6'																					
	S9	I-70	153.829	RT	E1-5	8'X2'																					
	S10	I-70	153.829	RT	E1-5	8'X2'																					
	S11	I-70	153.829	RT	E1-H3	15'X10'																					
	S12	I-70	153.837	RT	E5-H1a	8'X5'																					
	S13	SR 60G	0.085	LT	M2-H6	8'X7'																					
	S14	SR 60G	0.149	RT	M2-H6	8'X7'																					
	S15	I-70 RAMP U	153.816	RT	M2-H3	4'X6'																					
	S16	SR 60G	0.160	RT	M2-H4	9'X3'																					
	S17	I-70	154.076	RT	E7-H4	11'X5'																					
TOTALS CARRIED TO LAST SHEET OF SUBSUMMARY							2	2	9.3	252	1013				4	3		82	914	69	48	9			2		

SIGNING SUBSUMMARY

D05 - SIGN - FY 2005

CALCULATED
JAM
CHECKED
WEB

08/25/2004 03:26:40 PM M:\p\0221\0522 Sign Inventory\Project plans\sheetst\03170.dgn

SHEET NO.	REFERENCE NO.	LOCATION	STATION	SIDE	CODE	SIZE (FEET)	630	630	630	630	630	630	630	630	630	630	630	630	631	631	631	630			
							GROUND MOUNTED SUPPORT, W10X22 BEAM FT.	GROUND MOUNTED SUPPORT, W12X30 BEAM FT.	BREAKAWAY BEAM CONNECTION EACH	SIGN, FLAT SHEET SQ. FT.	SIGN, GROUND MOUNTED EXTRUSHEET SQ. FT.	SIGN, OVERHEAD EXTRUSHEET SQ. FT.	GROUND MOUNTED BEAM SUPPORT FOUNDATION EACH	GROUND MOUNTED SUPPORT NO. 4 POST FT.	REMOVAL OF GROUND MOUNTED SIGN AND DISPOSAL EACH	REMOVAL OF GROUND MOUNTED MAJOR SIGN AND DISPOSAL EACH	REMOVAL OF GROUND MOUNTED BEAM SUPPORT AND DISPOSAL EACH	REMOVAL OF OVERHEAD MOUNTED SIGN AND DISPOSAL EACH	SIGNING, MISC.: GROUND MOUNTED SUPPORT EACH	REMOVAL OF LUMINAIRE AND DISPOSAL EACH	REMOVAL OF BALLAST AND DISPOSAL EACH	REMOVAL OF SIGN SERVICE AND DISPOSAL, AS PER PLAN EACH	SIGNING, MISC.: CHECK TORQUE EACH		
79	S1	I-70	156.994	RT	E5-H1a	8'X5'					40														
	S2	I-70 SW RAMP	157.069	RT	D1-H6a	11'X4'					44														
	S3	I-70 SW RAMP	157.069	RT	M6-4	2.5'X2'																			
	S4	I-70 SW RAMP	157.069	RT	M1-5	3'X3'																			
	S5	SR 93	12.799	LT	M2-H6	7'X6'																			
	S6	SR 93	12.782	RT	D1-H6a	10'X4'																			
	S7	SR 93	12.782	RT	M6-3	1.75'X1.25'																			
	S8	SR 93	12.782	RT	M1-1	2'X2'																			
	S9	SR 93	12.782	RT	M3-4	2'X1'																			
	S10	SR 93	12.782	RT	M6-1	1.75'X1.25'																			
	S11	SR 93	12.782	RT	M1-1	2'X2'																			
	S12	SR 93	12.782	RT	M3-2	2'X1'																			
	S13	SR 93	12.817	RT	M2-H4	9'X3'																			
	S14	I-70	157.392	LT	E5-H1a	8'X5'																			
	S15	I-70 NE RAMP	157.289	LT	D1-H6a	11'X4'																			
	S16	I-70 NE RAMP	157.289	LT	M6-4	2.5'X2'																			
	S17	I-70 NE RAMP	157.289	LT	M1-5	3'X3'																			
	S18	SR 93	12.940	RT	M2-H6	7'X6'																			
	S19	SR 93	12.988	LT	M3-2	2'X1'																			
	S20	SR 93	12.988	LT	M1-1	2'X2'																			
	S21	SR 93	12.988	LT	M6-3	1.75'X1.25'																			
	S22	SR 93	12.988	LT	D1-H6a	10'X4'																			
	S23	SR 93	12.988	LT	M5-1	1.75'X1.25'																			
	S24	SR 93	12.988	LT	M1-1	2'X2'																			
	S25	SR 93	12.988	LT	M3-4	2'X1'																			
	S26	SR 93	12.924	LT	M2-H4	9'X3'																			
80	S1	I-70	157.555	LT	E1-5	8'X2'																			
	S2	I-70	157.555	LT	E1-H3	18'X12'																			
	S3	I-70	157.943	LT	E1-5	8'X2'																			
	S4	I-70	157.943	LT	E1-1	15'X12'																			
	S5	I-70	157.932	RT	R2-1	4'X5'																			
	S6	I-70	157.932	RT	R2-H2a	4'X5'																			
81	S1	I-70	158.360	LT	E1-5	8'X2'																			
	S2	I-70	158.360	LT	E1-1	15'X12'																			
	S3	I-70	158.625	LT	E3-H1	12'X5'																			
82	S1	I-70	159.439	RT	E1-1	14'X8'																			
	S2	I-70	159.439	RT	E1-5	8'X2'																			
	S3	I-70	159.610	LT	E7	15'X5'																			
	S4	I-70	159.932	RT	E1-1	14'X8'																			
	S5	I-70	159.932	RT	E1-5	8'X2'																			
	S6	I-70	159.835	LT	R2-H2a	4'X5'																			
	S7	I-70	159.835	LT	R2-1	4'X5'																			
83	S1	I-70	160.141	LT	D12-H11	10'X3'																			
	S2	I-70	160.141	LT	D12-H12	10'X1.25'																			
	S3	I-70	160.289	RT	E1-H3	17'X6'																			
	S4	I-70	160.289	RT	E1-5	8'X2'																			
TOTALS CARRIED TO LAST SHEET OF SUBSUMMARY							42	60	2	140.8	1562		4	138	26	18	6		2						10

SIGNING SUBSUMMARY

D05 - SIGN - FY 2005

CALCULATED
JAM
CHECKED
WEB

149
166

08/25/2004
03:27:33 PM
M:\proj\022\505\22 Sign Inventory\project plans\sheet\1504170.dgn

SHEET NO.	REFERENCE NO.	LOCATION	STATION	SIDE	CODE	SIZE (FEET)	630	630	630	630	630	630	630	630	630	630	630	630	630	630	630	630	630					
							SIGN ATTACHEMENT ASSEMBLY EACH	GROUND MOUNTED SUPPORT, W10X22 BEAM FT.	BREAKAWAY BEAM CONNECTION EACH	SIGN, FLAT SHEET SQ. FT.	SIGN, GROUND MOUNTED EXTRUSHEET SQ. FT.	SIGN, OVERHEAD EXTRUSHEET SQ. FT.	GROUND MOUNTED BEAM SUPPORT FOUNDATION EACH	GROUND MOUNTED SUPPORT NO. 4 POST FT.	REMOVAL OF GROUND MOUNTED SIGN AND DISPOSAL EACH	REMOVAL OF GROUND MOUNTED MAJOR SIGN AND DISPOSAL EACH	REMOVAL OF GROUND MOUNTED BEAM SUPPORT AND DISPOSAL EACH	REMOVAL OF GROUND MOUNTED POST SUPPORT AND DISPOSAL EACH	SIGNING, MISC.: GROUND MOUNTED SUPPORT EACH	REMOVAL OF LUMINAIRE AND DISPOSAL EACH	REMOVAL OF BALLAST AND DISPOSAL EACH	REMOVAL OF SIGN SERVICE AND DISPOSAL, AS PER PLAN EACH	SIGNING, MISC.: CHECK TORQUE EACH					
85	S1	CR 52	0.161	LT	M2-H4	9'X3'																						
	S2	CR 52	0.279	LT	M2-H4	9'X3'																						
	S3	CR 52	0.166	LT	D9-14a	8'X1.5'																						
	S4	CR 52	0.178	RT	M2-H6	7'X6'																						
	S5	I-70 NE RAMP	160.708	LT	D1-H6a	8'X4'																						
	S6	I-70	160.849	LT	E5-H1a	8'X5'																						
	S7	I-70	160.468	RT	E5-H1a	8'X5'																						
	S8	I-70 SW RAMP	160.570	RT	D1-H6a	8'X4'																						
	S9	SR 797	0.997	LT	M2-H6	7'X6'																						
	S10	CR 52	0.007	RT	M2-H4	9'X3'																						
	S11	SR 797	0.957	RT	M3-4	2'X1'																						
	S12	SR 797	0.957	RT	M1-1	2'X2'																						
	S13	SR 797	0.957	RT	M6-3	1.75'X1.25'																						
	S14	SR 797	0.957	RT	M3-2	2'X1'																						
	S15	SR 797	0.957	RT	M1-1	2'X2'																						
	S16	SR 797	0.957	RT	M6-1	1.75'X1.25'																						
	S17	SR 797	0.957	RT	D1-H6a	10'X4'																						
86	S1	I-70	161.025	LT	E1-5	8'X2'																						
	S2	I-70	161.025	LT	E1-H3	17'X6'																						
	S3	I-70	161.179	LT	E1-5	8'X2'																						
	S4	I-70	161.179	LT	D12-H16a	10'X2'																						
	S5	I-70	161.352	LT	E1-5	8'X2'																						
	S6	I-70	161.352	LT	E1-1	14'X8'																						
	S7	I-70	161.466	RT	R2-1	4'X5'																						
	S8	I-70	161.466	RT	R2-H2a	4'X5'																						
87	S1	I-70	161.769	RT	E7	15'X5'																						
	S2	I-70	161.863	LT	E1-5	8'X2'																						
	S3	I-70	161.863	LT	E1-1	14'X8'																						
	S4	I-70	162.271	LT	R2-H2a	4'X5'																						
	S5	I-70	162.271	LT	R2-1	4'X5'																						
88	S1	I-70	162.988	LT	D5-H6	6'X6'																						
	S2	I-70	163.052	RT	E1-1	11'X9'																						
	S3	I-70	163.052	RT	E1-5	8'X2'																						
	S4	I-70	163.158	LT	D5-H2	10'X5'																						
	S5	I-70	163.222	RT	E3-H1	20'X5'																						
	S6	I-70	163.222	RT	E1-5	8'X2'																						
	S7	I-70	163.317	LT	D5-H7	13'X5'																						
	S8	I-70	163.350	RT	E1-1	11'X9'																						
	S9	I-70	163.350	RT	E1-5	8'X2'																						
	S10	WB I-70	163.453	LT	D5-H14	10'X1.5'																						
	S11	WB I-70	163.453	LT	D5-I-SPECIAL	11'X8'																						
89	S1	EB I-70	163.833	RT	E1-H3	14'X8'																						
	S2	EB I-70	163.833	RT	E1-5	8'X2'																						
	S3	EB I-70	163.977	RT	E5-H1a	8'X5'																						
TOTALS CARRIED TO LAST SHEET OF SUBSUMMARY																												
							46	2	96.4	1614		2	168	23	19	6	1	3										

SIGNING SUBSUMMARY

D05 - SIGN - FY 2005

CALCULATED
JAM
CHECKED
WEB

08/25/2004 03:29:26 PM M:\p\ro\021\0505\22 Sign Inventory\project plans\sheet\ts06170.dgn

SHEET NO.	REFERENCE NO.	LOCATION	STATION	SIDE	CODE	SIZE (FEET)	630	630	630	630	630	630	630	630	630	630	630	630	631	631	631	630	
							SIGN ATTACHMENT ASSEMBLY EACH	GROUND MOUNTED SUPPORT, W/2X30 BEAM FT.	BREAKAWAY BEAM CONNECTION EACH	SIGN, FLAT SHEET SQ. FT.	SIGN, GROUND MOUNTED EXTRUSHEET SQ. FT.	SIGN, OVERHEAD EXTRUSHEET SQ. FT.	GROUND MOUNTED BEAM SUPPORT FOUNDATION EACH	GROUND MOUNTED SUPPORT NO. 4 POST FT.	REMOVAL OF GROUND MOUNTED SIGN AND DISPOSAL EACH	REMOVAL OF GROUND MOUNTED SIGN AND DISPOSAL EACH	REMOVAL OF GROUND MOUNTED BEAM SUPPORT AND DISPOSAL EACH	REMOVAL OF OVERHEAD MOUNTED SIGN AND DISPOSAL EACH	SIGNING, MISC.: GROUND MOUNTED SUPPORT EACH	REMOVAL OF LUMINAIRE AND DISPOSAL EACH	REMOVAL OF BALLAST AND DISPOSAL EACH	REMOVAL OF SIGN SERVICE AND DISPOSAL, AS PER PLAN EACH	SIGNING, MISC.: CHECK TORQUE EACH
98	S1	I-70	169.543	RT	E1-H3	20'X10'		29-28-24	3		200		3			1	2						
	S2	I-70	169.543	RT	E1-5	8'X2'					16				1								
	S3	I-70	169.685	RT	E5-H1a	8'X5'					40					1					1		
	S4	I-70 RAMP C	169.830	RT	D1-H6a	11'X4'					44					1							1
	S5	I-70 RAMP C	169.830	RT	M6-4	2'X2.5'				5					1								
	S6	I-70 RAMP C	169.830	RT	M1-5	2.5'X2.5'				6.3					1								
	S7	SR 83	0.276	RT	M2-H4	9'X3'					27				1								
	S8	SR 83	0.333	RT	D1-H6a	11'X4'					44					1							1
	S9	SR 83	0.383	RT	M2-H6	8'X7'					56					1							1
	S10	SR 83	0.397	RT	M2-H4	9'X3'					27				1								1
	S11	I-70 RAMP B	169.880	LT	D1-H6a	11'X4'					44					1							
	S12	I-70 RAMP B	169.880	LT	M6-4	2'X1.5'				3					1								
	S13	I-70 RAMP B	169.880	LT	M1-5	2.5'X2.5'				6.3					1								
	S14	SR 83	0.530	LT	M2-H6	9'X7'					63					1							1
	S15	SR 83	0.515	LT	M2-H4	9'X3'					27				1								
	S16	SR 83	0.579	LT	M2-H4	9'X3'					27				1								
	S17	SR 83	0.655	LT	D1-H6a	11'X4'					44					1							1
99	S1	I-70	170.003	LT	E5-H1a	8'X5'					40					1							1
	S2	I-70	170.182	LT	E1-5	8'X2'					16				1								
	S3	I-70	170.182	LT	E1-H3	20'X10'		33-29-25	3		200		3			1	2						
	S4	I-70	170.137	Q	E8-H3	8'X4'					32				1								1
	S5	I-70	170.137	Q	E8-H3	7'X4'					28				1								1
	S6	I-70	170.530	LT	E1-5	8'X2'					16				1								
	S7	I-70	170.530	LT	E3-H2	11'X3'					33				1								1
	S8	I-70	170.665	LT	E1-5	8'X2'					16				1								
	S9	I-70	170.665	LT	E1-1	17'X12'					204					1							
	S10	I-70	170.883	LT	E1-5	8'X2'					16				1								
	S11	I-70	170.883	LT	E3-H2	15'X4'					60					1							
	S12	I-70	170.883	LT	E3-H1	13'X5'					65					1							
	S13	I-70	170.798	RT	E7	14'X5'					70					1							
	S14	I-70	170.543	RT	R2-1	4'X5'				20				34		1	2						
	S15	I-70	170.543	RT	R2-H2a	4'X5'				20				35									
100	S1	I-70	171.082	LT	E1-5	8'X2'					16				1								
	S2	I-70	171.082	LT	E1-1	17'X12'					204					1							
101	S1	I-70	172.464	RT	D8-1	8'X6'					48					1							1
	S2	I-70	172.700	RT	R13-HI(MOD.)	10'X5'					50					1							1
	S3	I-70	172.914	RT	E7-H3	17'X12'					204					1							1
102	S1	I-70	173.114	RT	R13-HI	8'X4'					32				1								1
	S2	I-70	173.260	RT	SPECIAL	16'X6'					96					1							1
	S3	I-70	172.464	RT	D8-3	7'X6.5'					45.5					1							1
	S4	I-70	173.603	LT	D8-3	7'X6.5'					45.5					1							1
	S5	I-70	173.753	LT	SPECIAL	16'X6'					96					1							1
	S6	I-70	173.954	LT	R13-HI	8'X4'					32				1								1
103	S1	I-70	174.481	LT	R13-HI(MOD.)	10'X5'					50					1							1
	S2	I-70	174.526	LT	D8-1	8'X6'					48					1							1
	S3	I-70	174.901	RT	E1-1	14'X9'					126					1							1
	S4	I-70	174.901	RT	E1-5	8'X2'					16				1								1
TOTALS CARRIED TO LAST SHEET OF SUBSUMMARY								168	6	60.6	2564		6	69	20	26	6				2		15

SIGNING SUBSUMMARY

D05 - SIGN - FY 2005

CALCULATED
JAM
CREATED
WEB

08/25/2004
03:30:21 PM
M:\p\01\022\1505\22 Sign Inventory\project plans\sheet\ts01710.dgn

SHEET NO.	REFERENCE NO.	LOCATION	STATION	SIDE	CODE	SIZE (FEET)	630	630	630	630	630	630	630	630	630	630	630	630	631	631	631	630	
							SIGN ATTACHEMENT ASSEMBLY EACH	GROUND MOUNTED SUPPORT, W10X22 BEAM FT.	BREAKAWAY BEAM CONNECTION EACH	SIGN, FLAT SHEET SQ. FT.	SIGN, GROUND MOUNTED EXTRUSHEET SQ. FT.	SIGN, OVERHEAD EXTRUSHEET SQ. FT.	GROUND MOUNTED BEAM SUPPORT FOUNDATION EACH	GROUND MOUNTED SUPPORT NO. 4 POST FT.	REMOVAL OF GROUND MOUNTED SIGN AND DISPOSAL EACH	REMOVAL OF GROUND MOUNTED SIGN AND DISPOSAL EACH	REMOVAL OF GROUND MOUNTED BEAM SUPPORT AND DISPOSAL EACH	REMOVAL OF OVERHEAD MOUNTED SIGN AND DISPOSAL EACH	SIGNING, MISC.: GROUND MOUNTED SUPPORT EACH	REMOVAL OF LUMINAIRE AND DISPOSAL EACH	REMOVAL OF BALLAST AND DISPOSAL EACH	REMOVAL OF SIGN SERVICE AND DISPOSAL, AS PER PLAN EACH	SIGNING, MISC.: CHECK TORQUE EACH
104	S1	I-70	175.317	LT	E7	15'X7'																105	
	S2	I-70	175.230	RT	DI2-H16a	10'X2'																20	
	S3	I-70	175.230	RT	E3-H2	19'X5'																95	
	S4	I-70	175.230	RT	E1-5	8'X2'																	16
	S5	I-70	175.374	RT	E1-1	14'X9'																	126
	S6	I-70	175.374	RT	E1-5	8'X2'																	16
	S7	I-70	175.545	LT	R2-H2a	4'X5'				20													35
	S8	I-70	175.545	LT	R2-1	4'X5'				20													34
	S9	I-70	-	RT	D7-H17	10'X2.5'																	
	S10	I-70	-	RT	E1-5	8'X2'																	
	S11	I-70	175.831	RT	E1-1	17'X8'																	136
	S12	I-70	175.831	RT	E1-5	8'X2'																	16
	S13	I-70	175.993	RT	E5-H1a	8'X5'																	40
105	S1	SR 723	0.466	LT	M2-H4	9'X3'																27	
	S2	I-70	176.458	LT	E5-H1a	8'X5'																40	
106	S1	SR 723	0.690	LT	M2-H4	9'X3'																27	
	S2	SR 723	0.616	LT	DI-H6a	11'X4'																44	
	S3	SR 723	0.692	RT	M1-4	2.5'X2.5'				6.3													
	S4	SR 723	0.692	RT	M6-4	1.75'X1.25'				2.2													
	S5	SR 723	0.692	RT	DI-H6a	12'X4'																	48
	S6	SR 723	0.692	RT	M1-4	2.5'X2.5'				6.3													
	S7	SR 723	0.692	RT	M6-4	1.75'X1.25'				2.2													
	S8	SR 723	0.734	RT	NP-30	2'X6'																	
	S9	SR 723	0.734	RT	D9-14a	8'X1.5'																	12
107	S1	I-70	176.620	LT	E1-5	8'X2'																16	
	S2	I-70	176.620	LT	E1-H3	17'X8'																	136
	S3	I-70	176.909	LT	E3-H2	12'X5'																	60
	S4	I-70	176.971	RT	E7	14'X5'																	70
	S5	I-70	177.028	LT	E1-5	8'X2'																	16
	S6	I-70	177.028	LT	E1-1	14'X9'																	126
	S7	I-70	177.195	LT	E1-5	8'X2'																	16
	S8	I-70	177.195	LT	E3-H2	19'X7'																	133
	S9	I-70	177.195	LT	DI2-H16a	10'X2'																	20
	S10	I-70	177.487	LT	E1-5	8'X2'																	16
	S11	I-70	177.487	LT	E1-1	14'X9'																	126
	S12	I-70	176.783	RT	R2-1	4'X5'																	20
	S13	I-70	176.783	RT	R2-H2a	4'X5'																	20
TOTALS CARRIED TO LAST SHEET OF SUBSUMMARY																						101	
																						2	
																							97.0
																							1503
																							4
																							138
																							17
																							18
																							10
																							2
																							6

SIGNING SUBSUMMARY

D05 - SIGN - FY 2005

CALCULATED
JAM
CHECKED
WEB

08/25/2004
03:35:43 PM
M:\proj\022\1505\22 Sign Inventory\project plans\sheet\1502170.dgn

SHEET NO.	REFERENCE NO.	LOCATION	STATION	SIDE	CODE	SIZE (FEET)	630	630	630	630	630	630	630	630	630	630	630	630	631	631	631	630			
							GROUND MOUNTED SUPPORT, W10X22 BEAM FT.	GROUND MOUNTED SUPPORT, W12X30 BEAM FT.	BREAKAWAY BEAM CONNECTION EACH	SIGN, FLAT SHEET SQ. FT.	SIGN, GROUND MOUNTED EXTRUSHEET SQ. FT.	SIGN, OVERHEAD EXTRUSHEET SQ. FT.	GROUND MOUNTED BEAM SUPPORT FOUNDATION EACH	GROUND MOUNTED SUPPORT NO. 4 POST FT.	REMOVAL OF GROUND MOUNTED SIGN AND DISPOSAL EACH	REMOVAL OF GROUND MOUNTED MAJOR SIGN AND DISPOSAL EACH	REMOVAL OF GROUND MOUNTED BEAM SUPPORT AND DISPOSAL EACH	REMOVAL OF OVERHEAD MOUNTED SIGN AND DISPOSAL EACH	SIGNING, MISC.: GROUND MOUNTED SUPPORT EACH	REMOVAL OF LUMINAIRE AND DISPOSAL EACH	REMOVAL OF BALLAST AND DISPOSAL EACH	REMOVAL OF SIGN SERVICE AND DISPOSAL, AS PER PLAN EACH	SIGNING, MISC.: CHECK TORQUE EACH		
122	SI3	I-70 RAMP D	186.595	RT	D1-H7a	14'X6'					84						1	1					1		
	SI4	I-70 RAMP D	186.595	RT	M6-1	2'X1.5'				3															
	SI5	I-70 RAMP D	186.595	RT	M1-4	2.5'X2.5'				6.3															
	SI6	I-70 RAMP D	186.595	RT	M1-5	3.125'X2.5'				7.8															
	SI7	I-70 RAMP D	186.595	RT	M6-4	2'X1.5'				3															
	SI8	I-70 RAMP D	186.595	RT	M3-2	2.5'X1.25'				3.1															
	SI9	SR 285	8.030	LT	M2-H6	9'X6'					54													1	
	S20	SR 285	8.031	RT	M2-H4	9'X3'					27														
	S21	SR 285	8.031	RT	M2-H4	9'X3'					27														
	S22	SR 285	7.888	RT	M2-H4	9'X3'					27														
	S23	SR 285	7.888	RT	M2-H4	9'X3'					27														
	123	SI	I-70	187.057	LT	E1-5	8'X2'					16						1							
		S2	I-70	187.057	LT	E1-H3	23'X10'					230							1						
S3		I-70	187.240	LT	E1-5	-												1							
S4		I-70	187.240	LT	D9-H17	-													1	2					
S5		I-70	187.445	LT	E1-5	8'X2'					16							1							
S6		I-70	187.445	LT	E1-1	20'X12'					240							1							
S7		I-70	187.445	LT	-	13'X3'					39							1							
S8		I-70	187.553	LT	E1-5	8'X2'					16							1							
S9		I-70	187.553	LT	E3-H1	18'X5'					90							1							
SI0		I-70	187.743	RT	D12-H12	10'X1.25'					12.5							1							
SI1		I-70	187.743	RT	D12-H11	10'X3'					30							1						1	
SI2		I-70	187.900	LT	E1-5	8'X2'					16							1						1	
SI3		I-70	187.900	LT	E1-1	20'X12'					240							1						1	
SI4		I-70	187.900	LT	E2-1	13'X2'					26							1						1	
SI5		I-70	187.609	RT	R2-1	4'X5'			20									1		2					
SI6		I-70	187.609	RT	R2-H2a	4'X5'			20																
SI7		I-70	187.900	RT	E7	14'X5'	22-17		2		70		2		34										
124	SI	I-70	188.550	RT	D5-1-SPECIAL	11'X8'					88							1							
	S2	I-70	188.550	RT	D5-H14	10'X1.5'					15							1							
	S3	I-70	188.550	RT	D5-H15	-													1						
	S4	I-70	188.758	RT	D5-H7	13'X5'					65								1					1	
125	SI	I-70	189.354	RT	D5-H2	10'X5'					50								1						
	S2	I-70	189.516	RT	D5-H6	6'X6'					36							1							
128	SI	I-70	192.205	RT	E1-1	16'X9'					144								1					1	
	S2	I-70	192.205	RT	E1-5	8'X2'					16							1							
	S3	I-70	192.451	LT	E7	14'X5'					70								1					1	
	S4	I-70	192.621	RT	E1-1	16'X9'					144									1					1
	S5	I-70	192.621	RT	E1-5	8'X2'					16								1						
	S6	I-70	192.830	RT	D9-H17	-														1	2				
	S7	I-70	192.830	RT	E1-5	-													1						
	S8	I-70	192.638	LT	R2-H2a	4'X5'			20											1		2			
	S9	I-70	192.638	LT	R2-1	4'X5'			20													35	34		
129	SI	I-70	193.052	RT	E1-H3	19'X8'		26-28	2		152		2						1		2				
	S2	I-70	193.052	RT	E1-5	8'X2'					16								1						
	S3	I-70	193.214	RT	E5-H1a	8'X5'					40									1					
	S4	I-70	193.572	LT	E5-H1a	8'X5'					40										1				
	S5	I-70	193.729	LT	E1-5	8'X2'					16														
TOTALS CARRIED TO LAST SHEET OF SUBSUMMARY							39	54	4	103.2	2196		4	138	23	19	11			2			8		

SIGNING SUBSUMMARY

D05-SIGN-FY2005

CALCULATED
JAM
CHECKED
WEB

157
166

08/25/2004 03:36:17 PM M:\p\o\1022\50522 Sign Inventory\project plans\sheet\ts02270.dgn

SHEET NO.	REFERENCE NO.	LOCATION	STATION	SIDE	CODE	SIZE (FEET)	630	630	630	630	630	630	630	630	630	630	630	630	630	630	630	630	630	
							GROUND MOUNTED SUPPORT, W10X22 BEAM FT.	GROUND MOUNTED SUPPORT, W12X30 BEAM FT.	BREAKAWAY BEAM CONNECTION EACH	SIGN, FLAT SHEET SQ. FT.	SIGN, GROUND MOUNTED EXTRUSHEET SQ. FT.	SIGN, OVERHEAD EXTRUSHEET SQ. FT.	GROUND MOUNTED BEAM SUPPORT FOUNDATION EACH	GROUND MOUNTED SUPPORT NO. 4 POST FT.	REMOVAL OF GROUND MOUNTED SIGN AND DISPOSAL EACH	REMOVAL OF GROUND MOUNTED SIGN AND DISPOSAL EACH	REMOVAL OF GROUND MOUNTED BEAM SUPPORT AND DISPOSAL EACH	REMOVAL OF OVERHEAD MOUNTED SIGN AND DISPOSAL EACH	SIGNING, MISC.: GROUND MOUNTED SUPPORT EACH	REMOVAL OF LUMINAIRE AND DISPOSAL EACH	REMOVAL OF BALLAST AND DISPOSAL EACH	REMOVAL OF SIGN SERVICE AND DISPOSAL, AS PER PLAN EACH	SIGNING, MISC.: CHECK TORQUE EACH	
129	S6	I-70	193.729	LT	E1-H3	19'X8'		25-26			152		2			1	2							
131	S1	SR 513	8.868	LT	M2-H4	9'X3'					27				1									
	S2	SR 513	8.868	LT	M2-H4	9'X3'					27				1									
	S3	SR 513	8.844	LT	D1-H6a	11'X4'					44				1								1	
	S4	SR 513	8.771	LT	M2-H4	9'X3'					27				1									
	S5	SR 513	8.771	LT	M2-H4	9'X3'					27				1									
	S6	SR 513	8.785	RT	M2-H6	9'X6'					54				1								1	
	S7	I-70 RAMP B	193.493	LT	M1-5	3.125'X2.5'			7.8						1									
	S8	I-70 RAMP B	193.493	LT	M6-4	2'X1.5'			3						1									
	S9	I-70 RAMP B	193.493	LT	D1-H5a	11'X2'					22				1									
	S10	I-70 RAMP C	193.332	RT	D1-H5a	11'X2'					22				1									
	S11	I-70 RAMP C	193.332	RT	M6-4	2'X1.5'			3						1									
	S12	I-70 RAMP C	193.332	RT	M1-5	3.125'X2.5'			7.8						1									
	S13	SR 513	8.672	LT	M2-H6	9'X6'					54				1									
	S14	SR 513	8.684	RT	M2-H4	9'X3'					27				1									
	S15	SR 513	8.684	RT	M2-H4	9'X3'					27				1									
	S16	SR 513	8.624	RT	D1-H6a	11'X4'					44				1									
	S17	SR 513	8.547	RT	M2-H4	9'X3'					27				1									
	S18	SR 513	8.547	RT	M2-H4	9'X3'					27				1									
132	S1	I-70	194.136	LT	E1-5	8'X2'					16				1									
	S2	I-70	194.136	LT	E1-1	16'X9'					144					1								1
	S3	I-70	194.383	RT	E7	14'X5'					70					1								
	S4	I-70	-	LT	E1-5	-										1								
	S5	I-70	-	LT	D9-H17	-										1	2							
	S6	I-70	194.506	LT	E1-5	8'X2'					16				1									
	S7	I-70	194.506	LT	E1-1	16'X9'					144					1								1
	S8	I-70	194.195	RT	R2-1	4'X5'			20					34		1	2							
	S9	I-70	194.195	RT	R2-H2a	4'X5'			20					35										
135	S1	I-70	197.417	RT	E1-2	18'X8'					144					1								1
	S2	I-70	197.417	RT	E1-5	8'X2'					16				1									
	S3	I-70	-	RT	D9-H17	-										1	2							
	S4	I-70	-	RT	E1-5	-										1								
	S5	I-70	197.815	LT	E7	14'X5'					70					1								1
	S6	I-70	197.886	RT	E1-2	18'X8'					144					1								
	S7	I-70	197.886	RT	E1-5	8'X2'					16				1									
	S8	I-70	180.034	RT	R2-H2a	4'X5'			20					35		1	2							
	S9	I-70	180.034	RT	R2-1	4'X5'			20					34										
136	S1	I-70	198.103	RT	E8-H2	6'X3'				18					1									
	S2	I-70	198.105	LT	R16-H15	12'X5'					60					1								
	S3	I-70	198.375	RT	E1-1	21'X6'	20-22-25				126		3			1	2							
	S4	I-70	198.375	RT	E1-5	8'X2'					16				1									
	S5	I-70	198.534	RT	E5-H1a	8'X5'					40					1								
	S6	I-70	198.633	Q	E8-H3	7'X4'					28				1									1
	S7	I-70	198.633	Q	E8-H3	6'X4'					24				1									
	S8	I-70	198.631	RT	D1-H4a	9'X2'					18				1									
	S9	I-70	198.631	RT	D3-H5	11'X4'					44					1								
TOTALS CARRIED TO LAST SHEET OF SUBSUMMARY							67	51	2	119.6	1744		5	138	23	21	12		1					7

SIGNING SUBSUMMARY

D05 - SIGN - FY 2005

CALCULATED
JAM
CHECKED
WEB

158
166

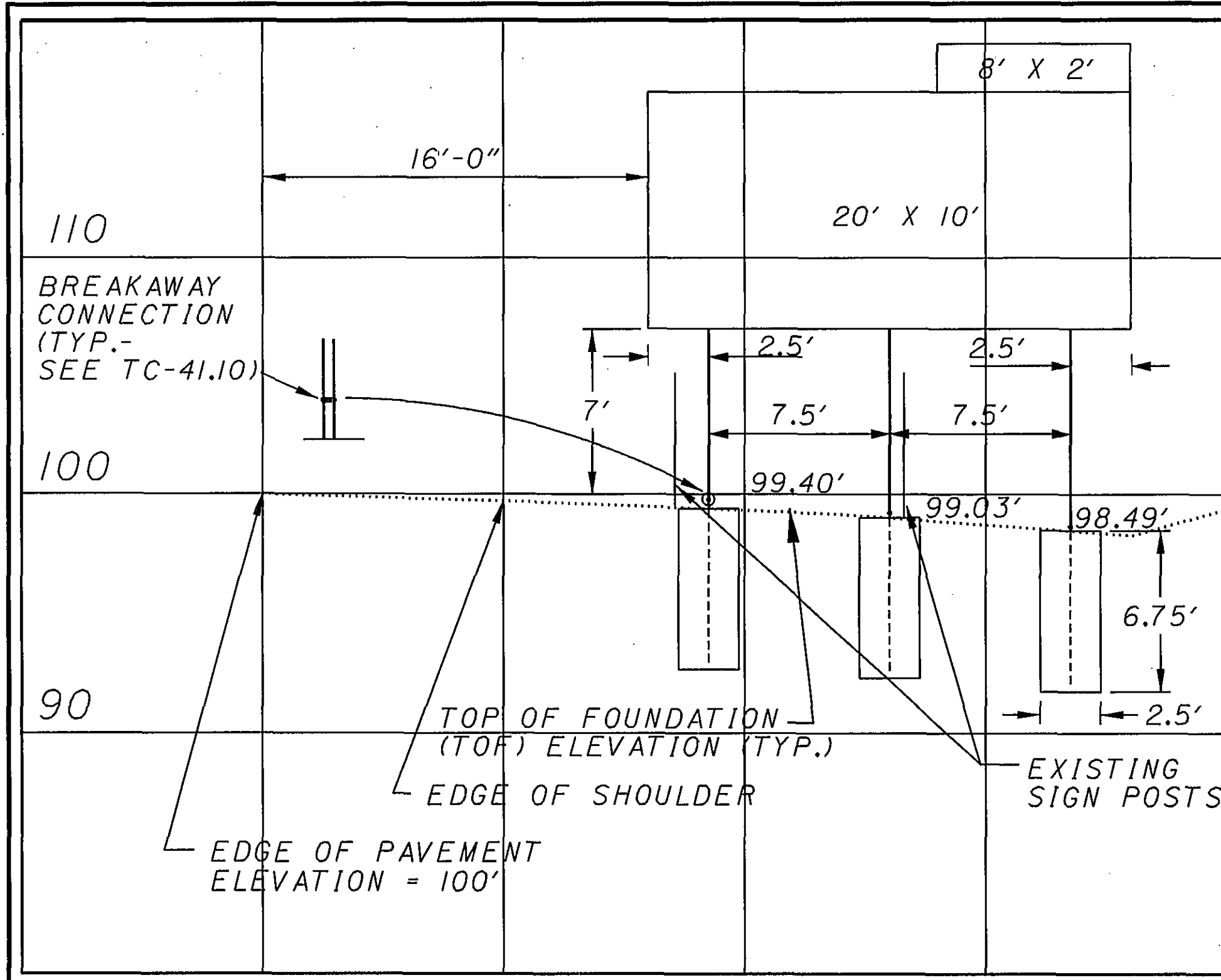

MILE 112.553, IR 70 WB
W10X22, 25'-25'-25'
SHEET 9, S12

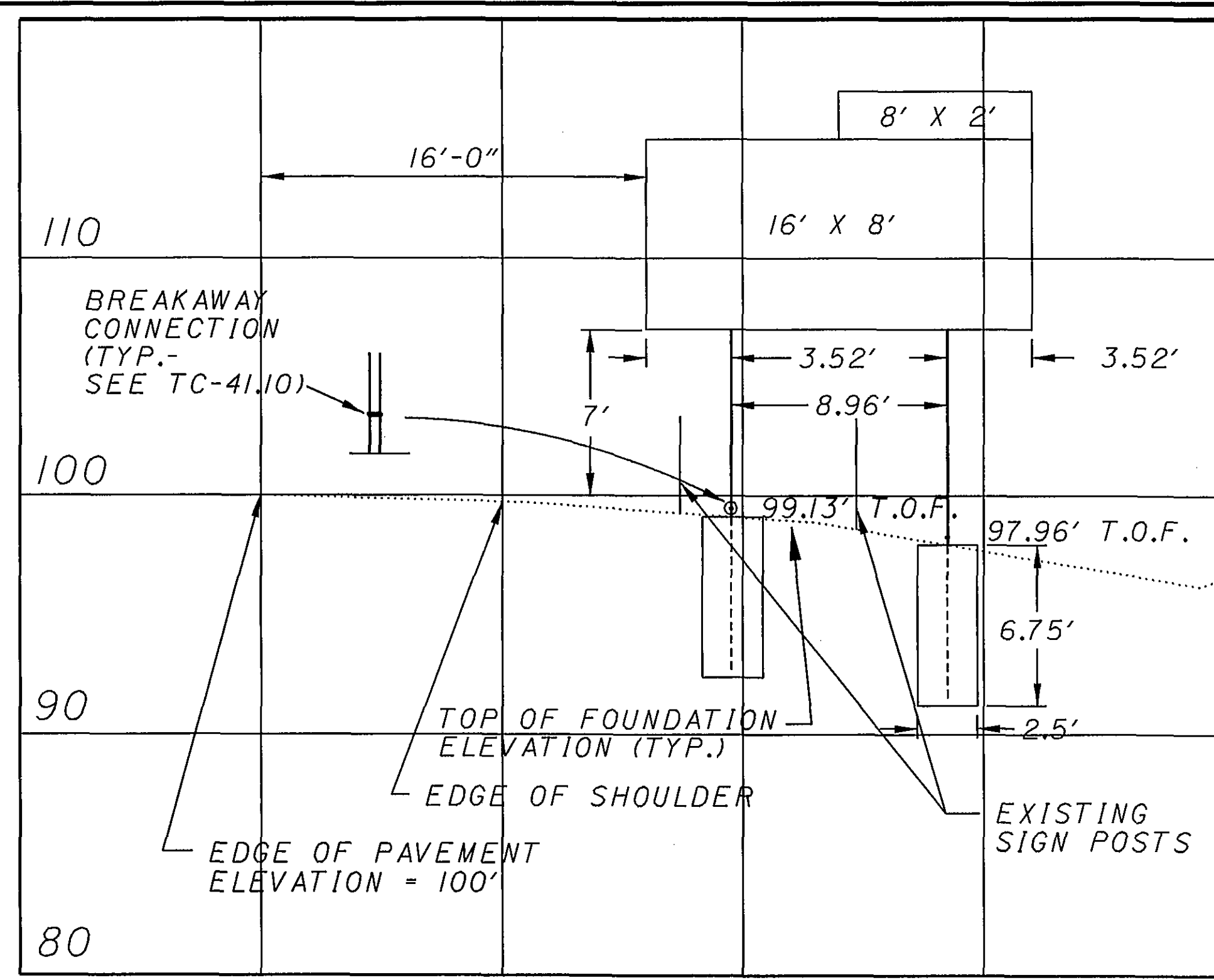

MILE 117.908, IR 70 EB
W10X22, 23'-24'
SHEET 14, S6

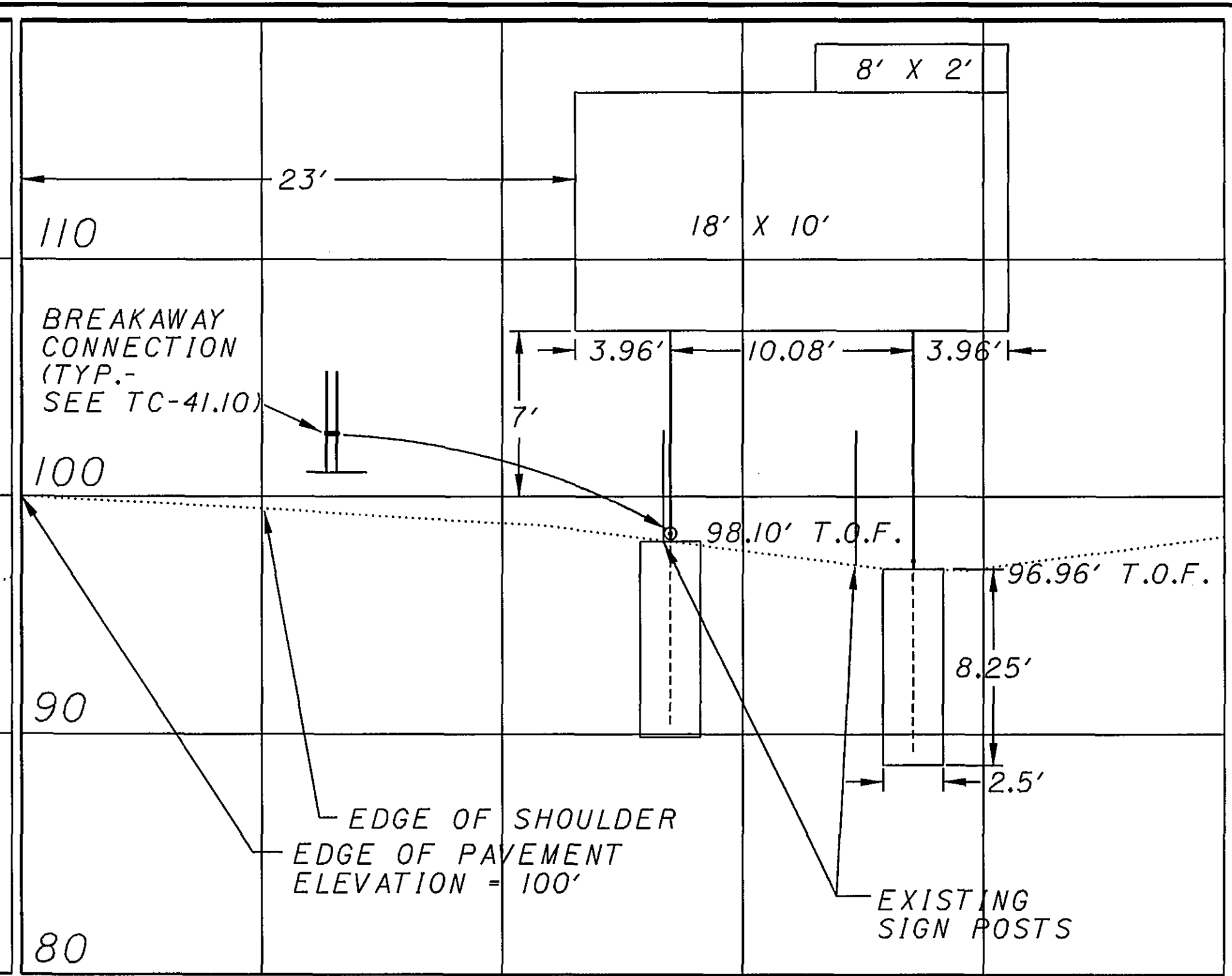

MILE 122.314, IR 70 EB
W12X30, 22'-24'
SHEET 21, S4

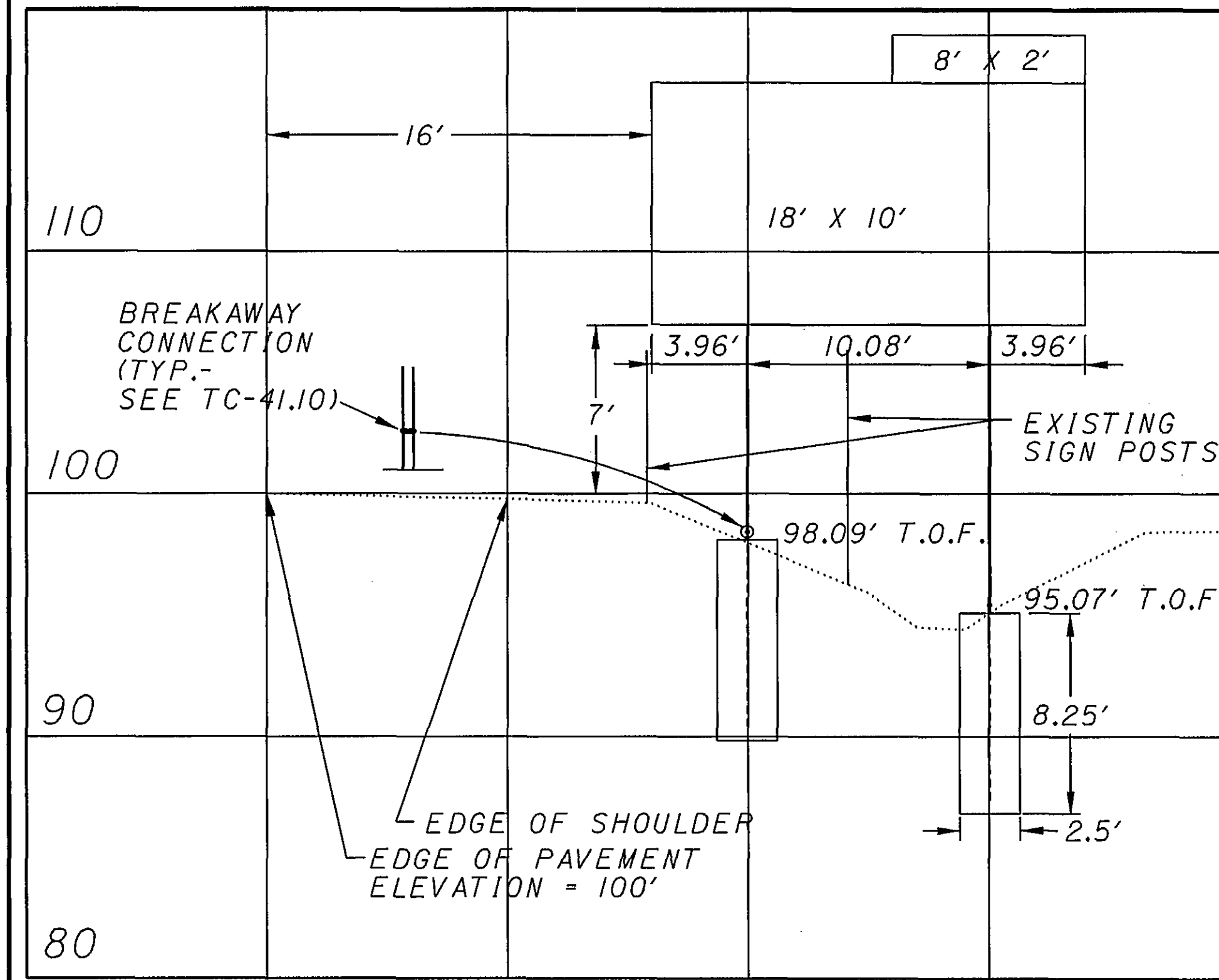

MILE 122.918, IR 70 WB
W12X30, 28'-30'
SHEET 21, S9

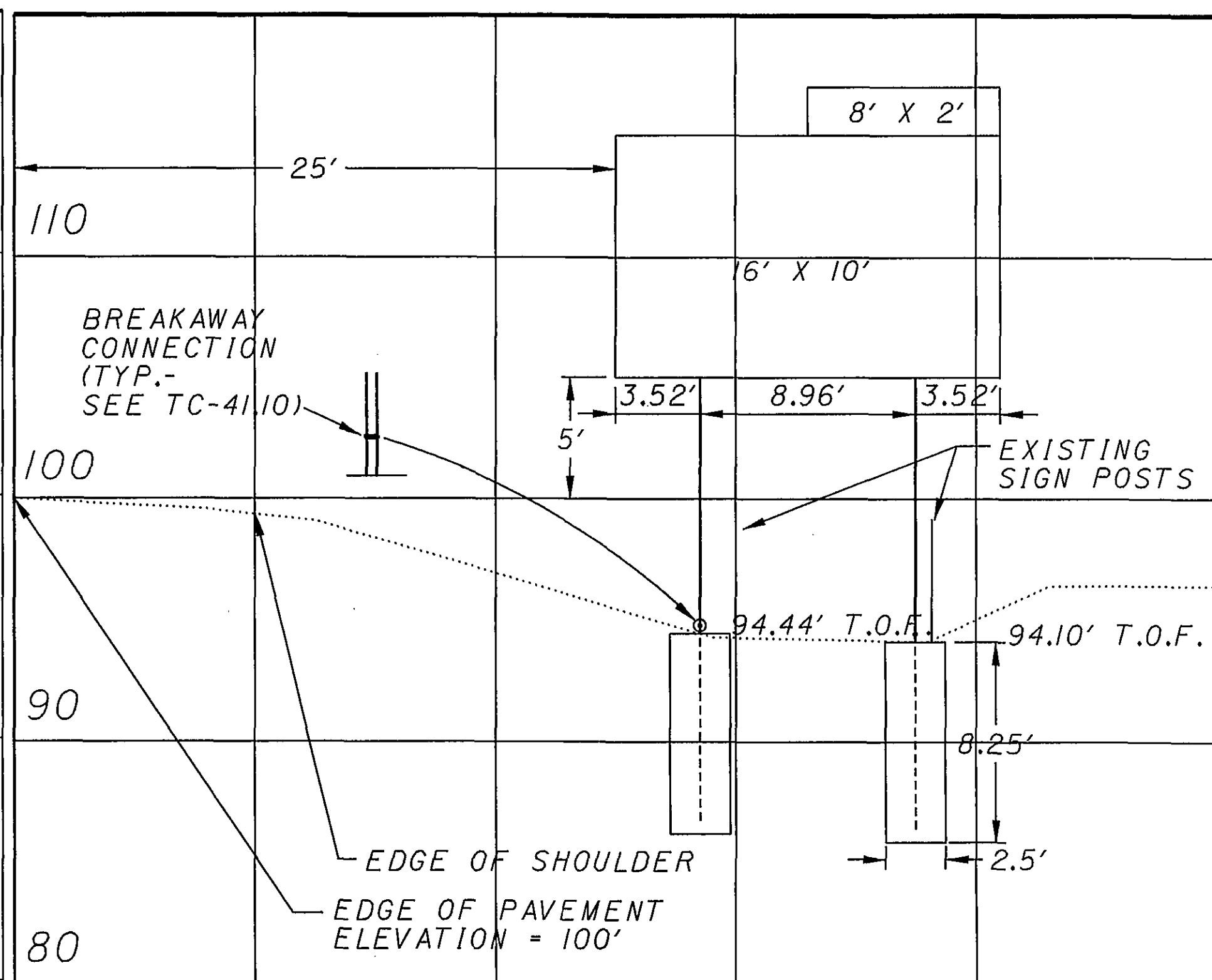

MILE 126.382, IR 70 WB
W12X30, 29'-29'
SHEET 29, S2

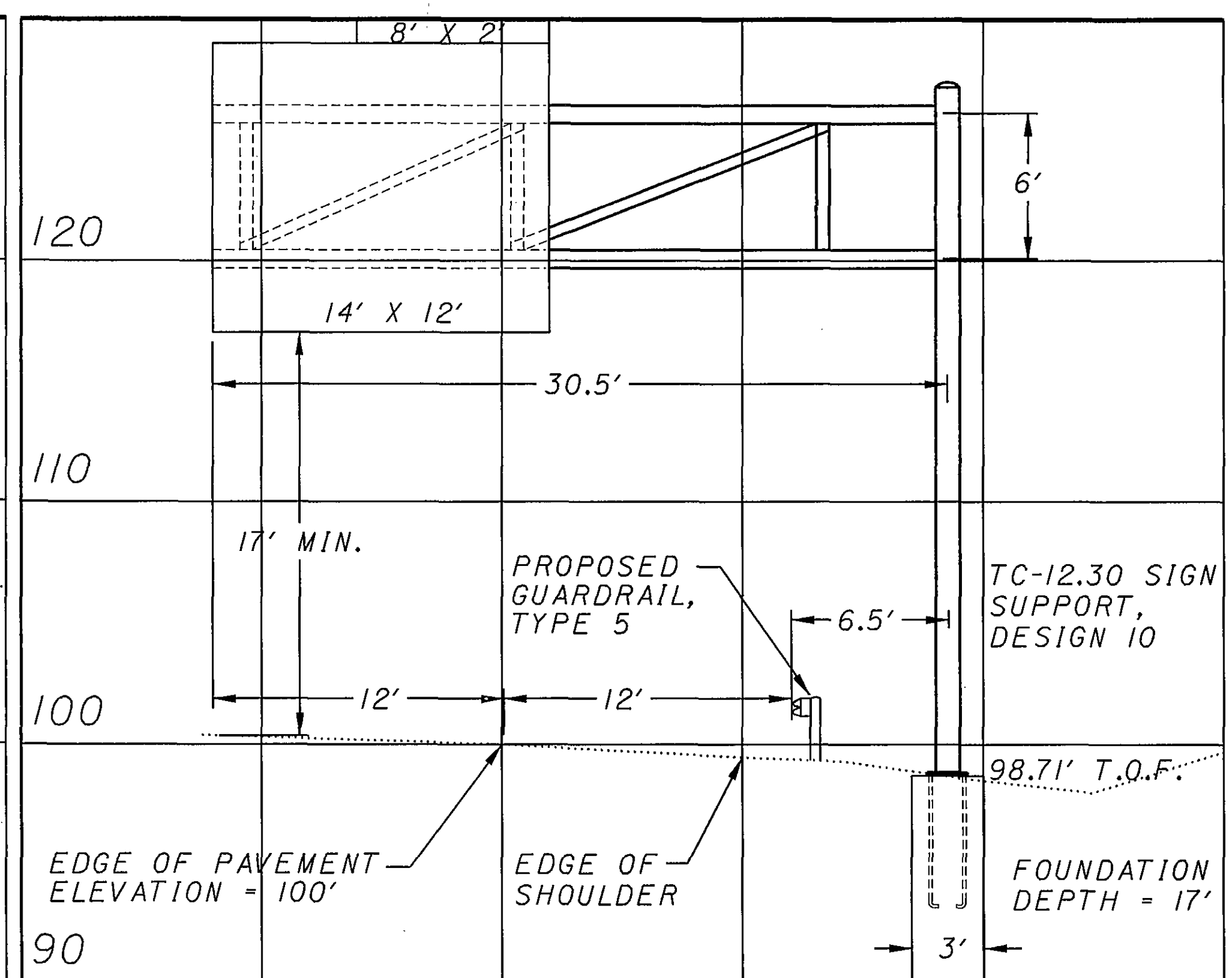

MILE 131.666, IR 70 EB
TC-12.30, DESIGN 10
SHEET 38, S5

T.O.F. = TOP OF FOUNDATION ELEVATION

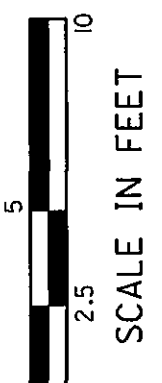

CALCULATED
DCB
CHECKED
KO

SIGN ELEVATIONS

D05-SIGN-FY2005

08/25/2004 10:27:59 AM M:\proj\022\1505\22 Sign Inventory\project plans\sheets\1d004170.dgn

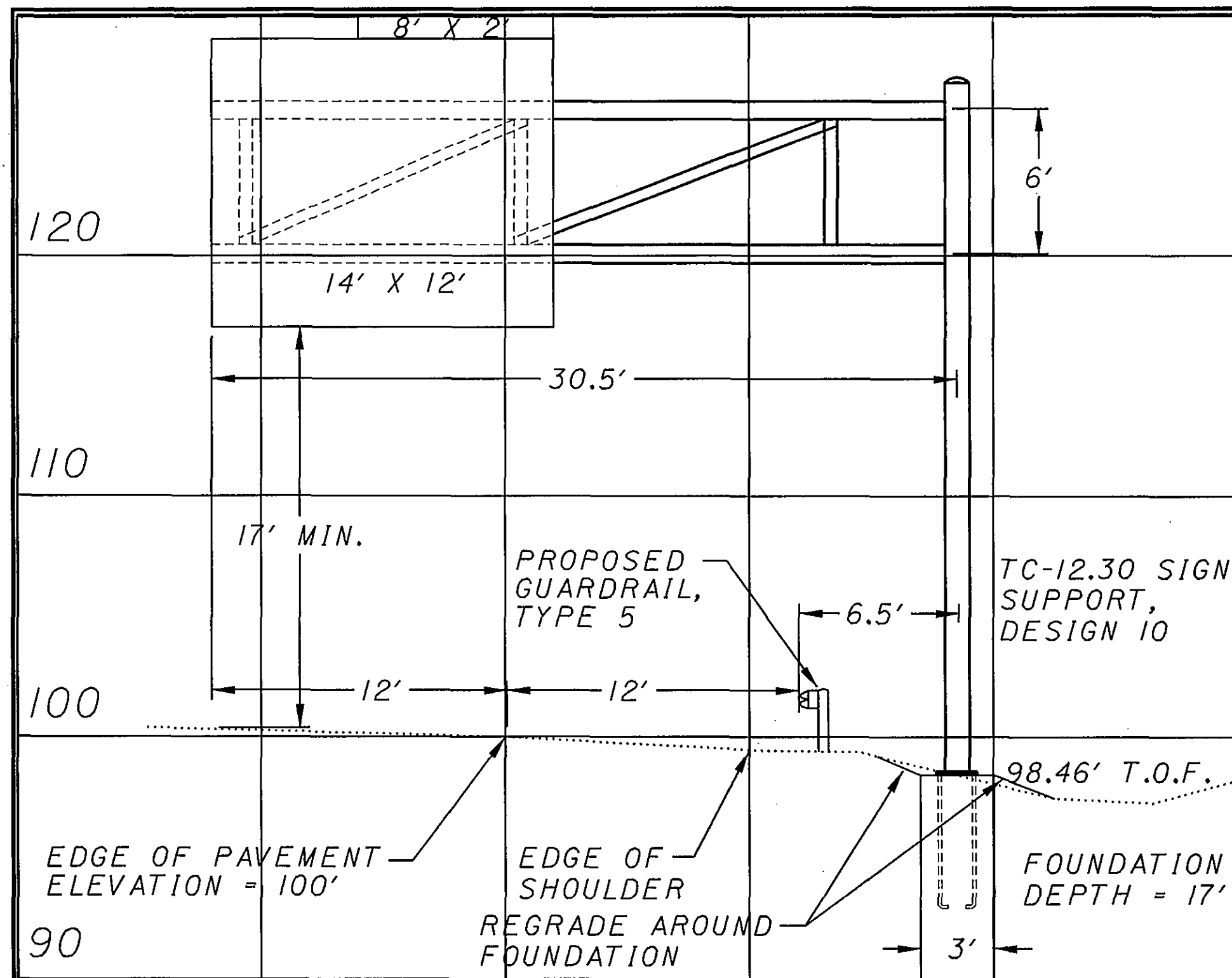

MILE 132.146, IR 70 EB
TC-12.30, DESIGN 10
SHEET 39, S5

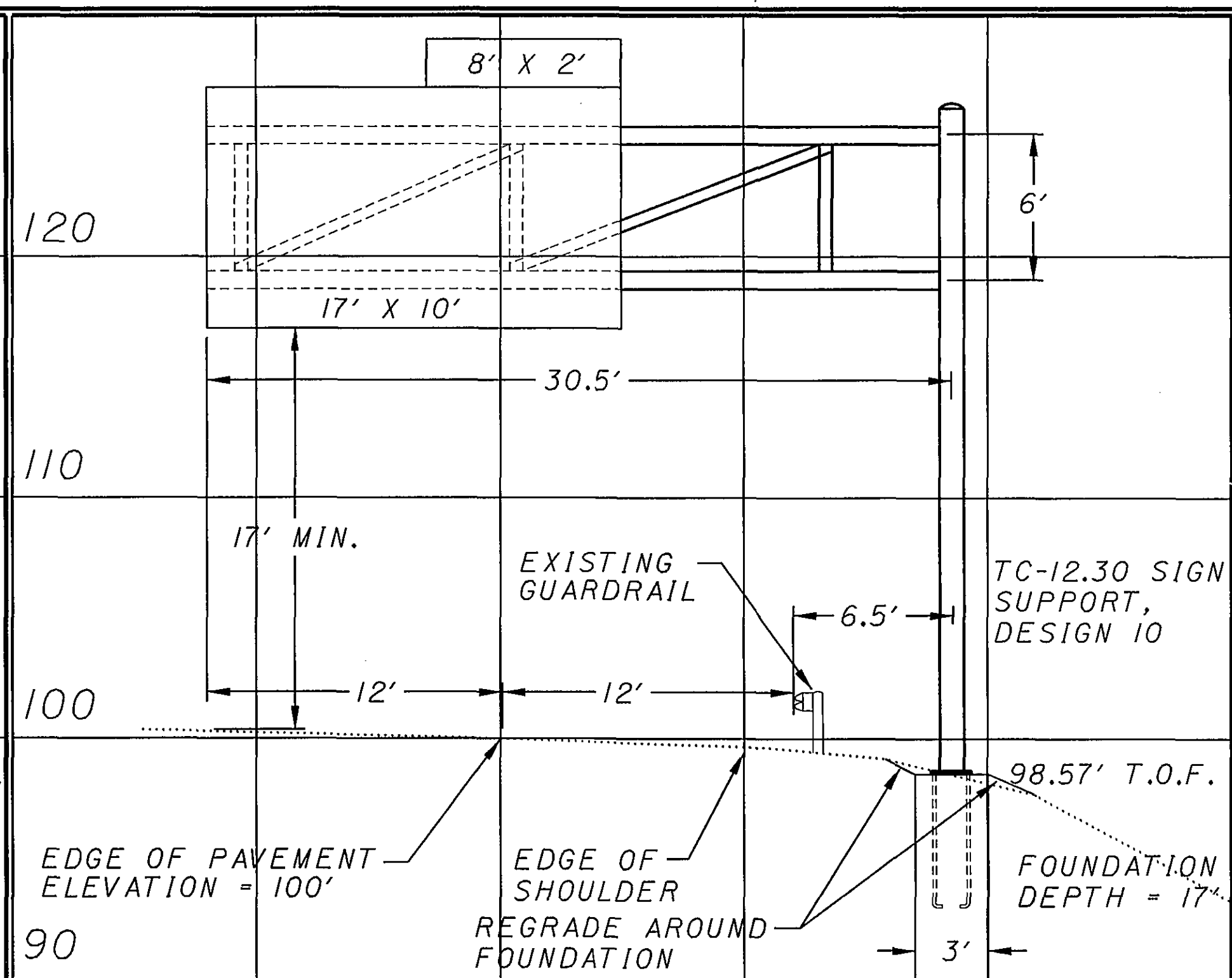

MILE 132.500, IR 70 EB
TC-12.30, DESIGN 10
SHEET 39, S11

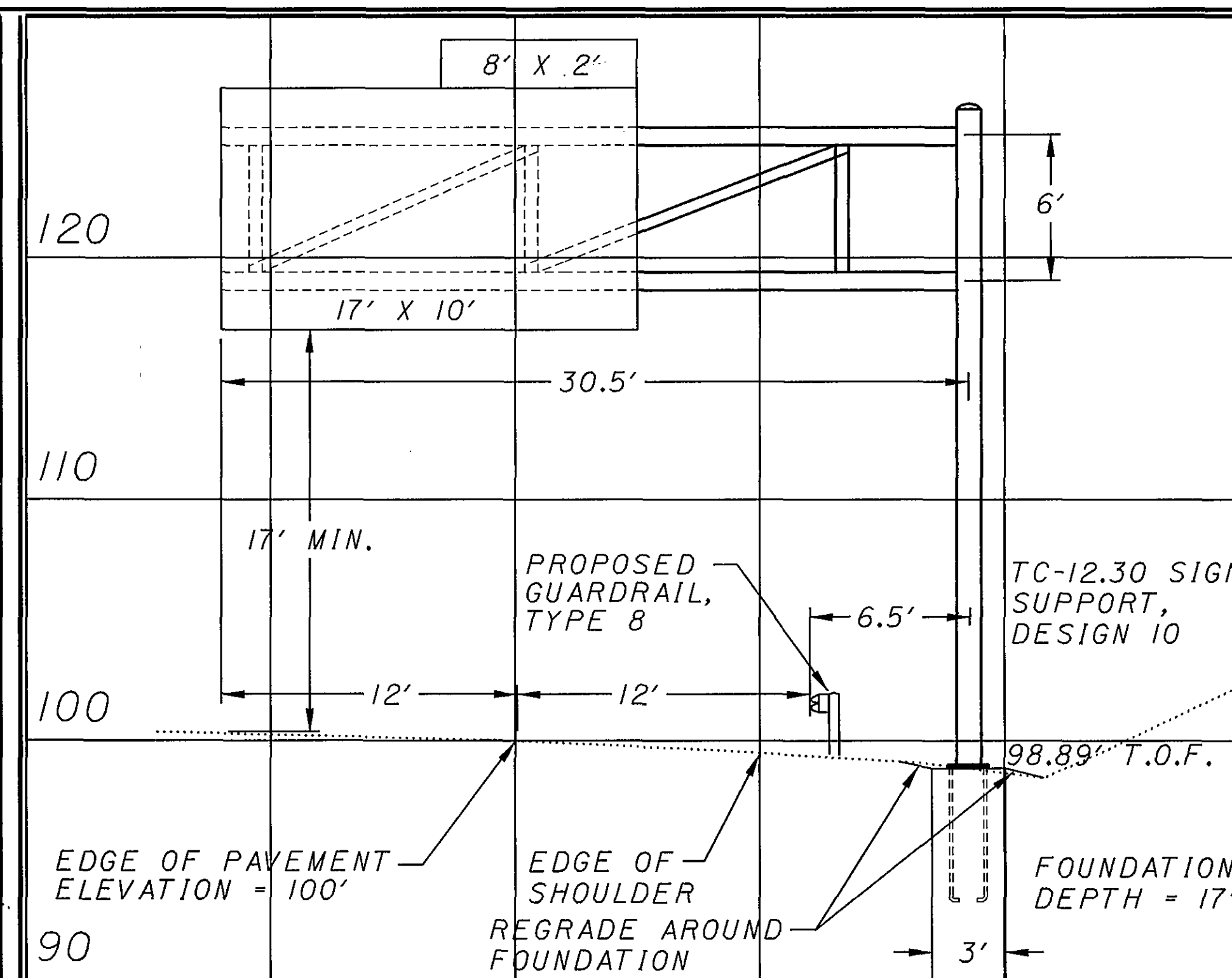

MILE 133.195, IR 70 WB
TC-12.30, DESIGN 10
SHEET 42, S3

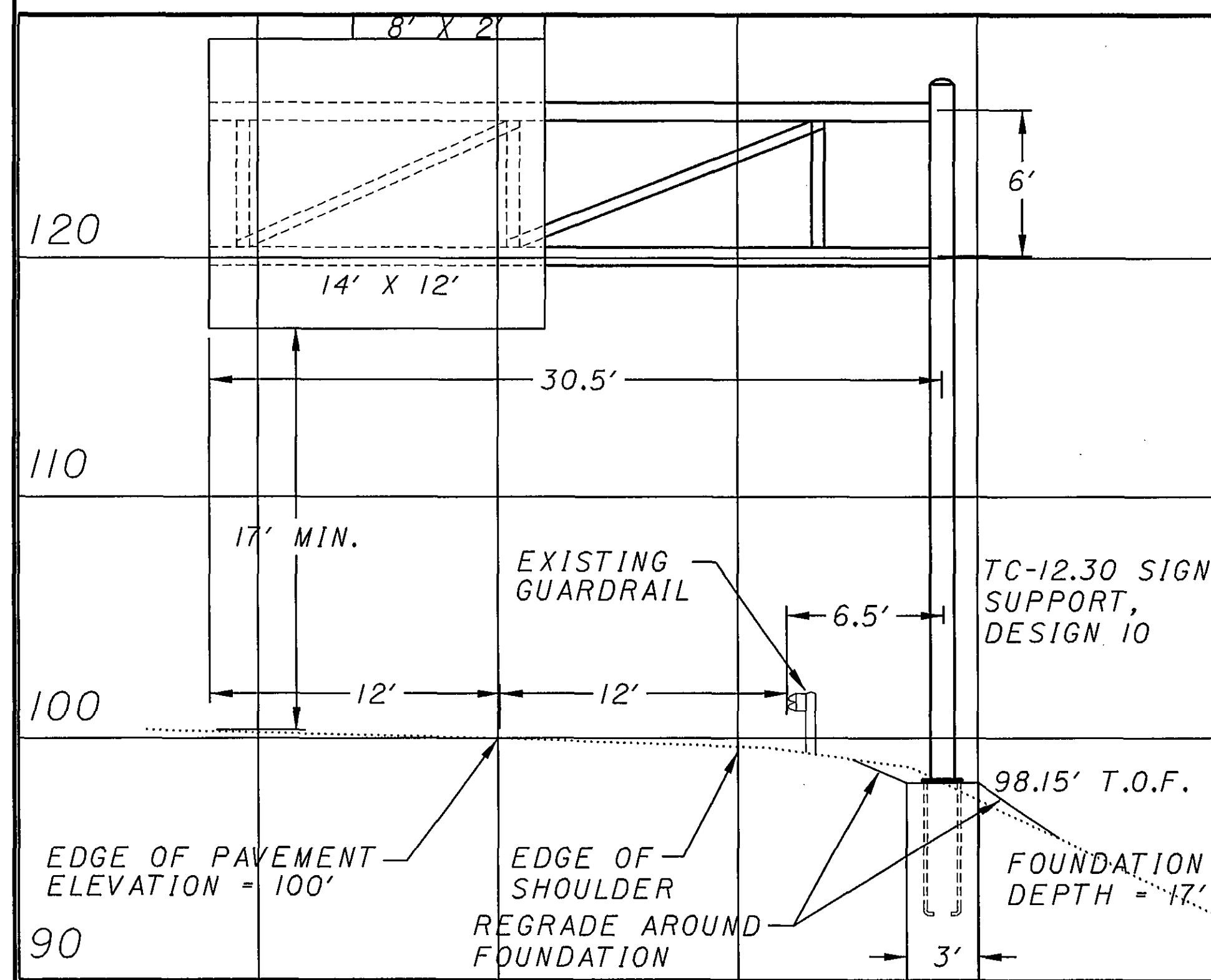

MILE 133.512, IR 70 WB
TC-12.30, DESIGN 10
SHEET 42, S7

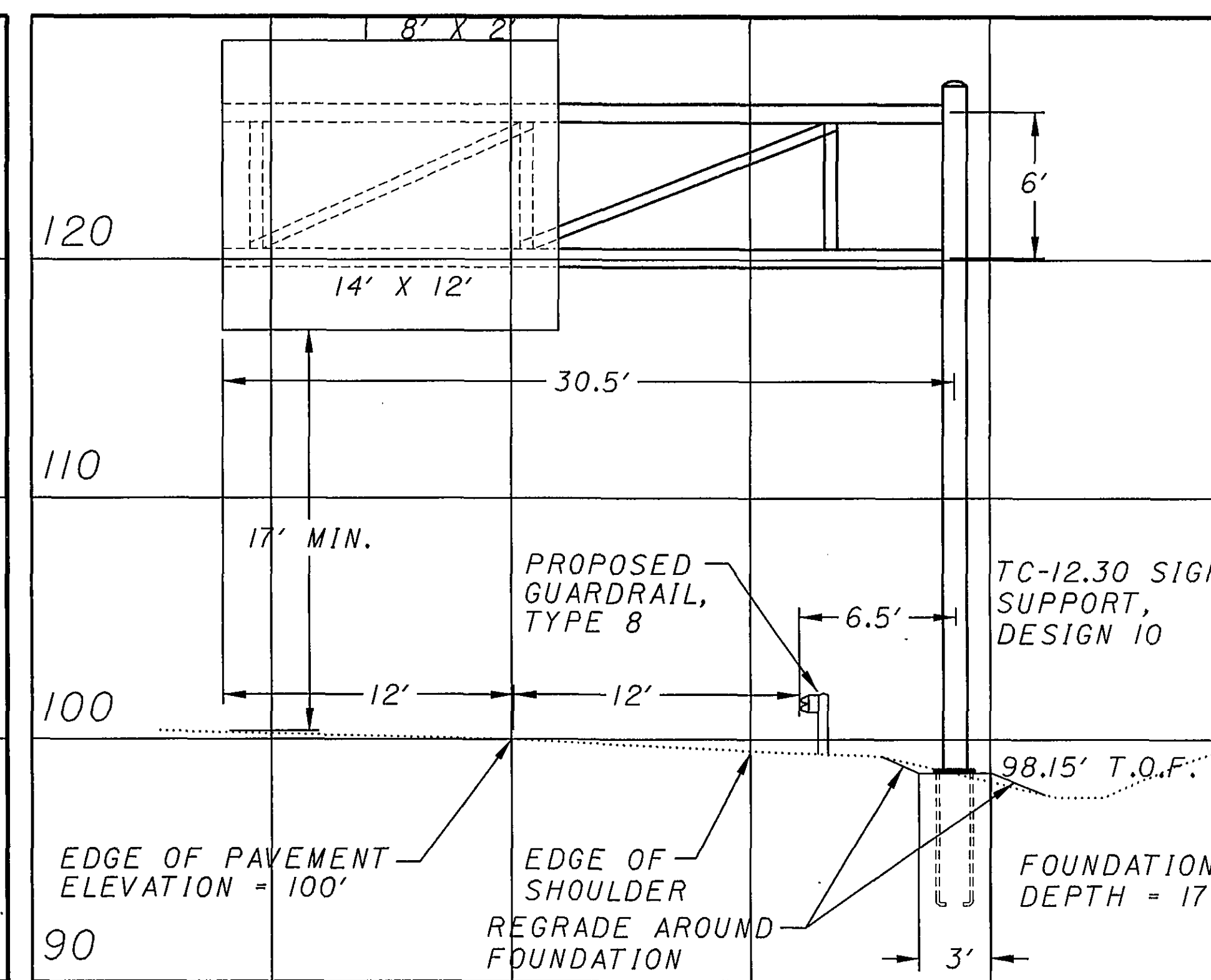

MILE 134.030, IR 70 WB
TC-12.30, DESIGN 10
SHEET 43, S2

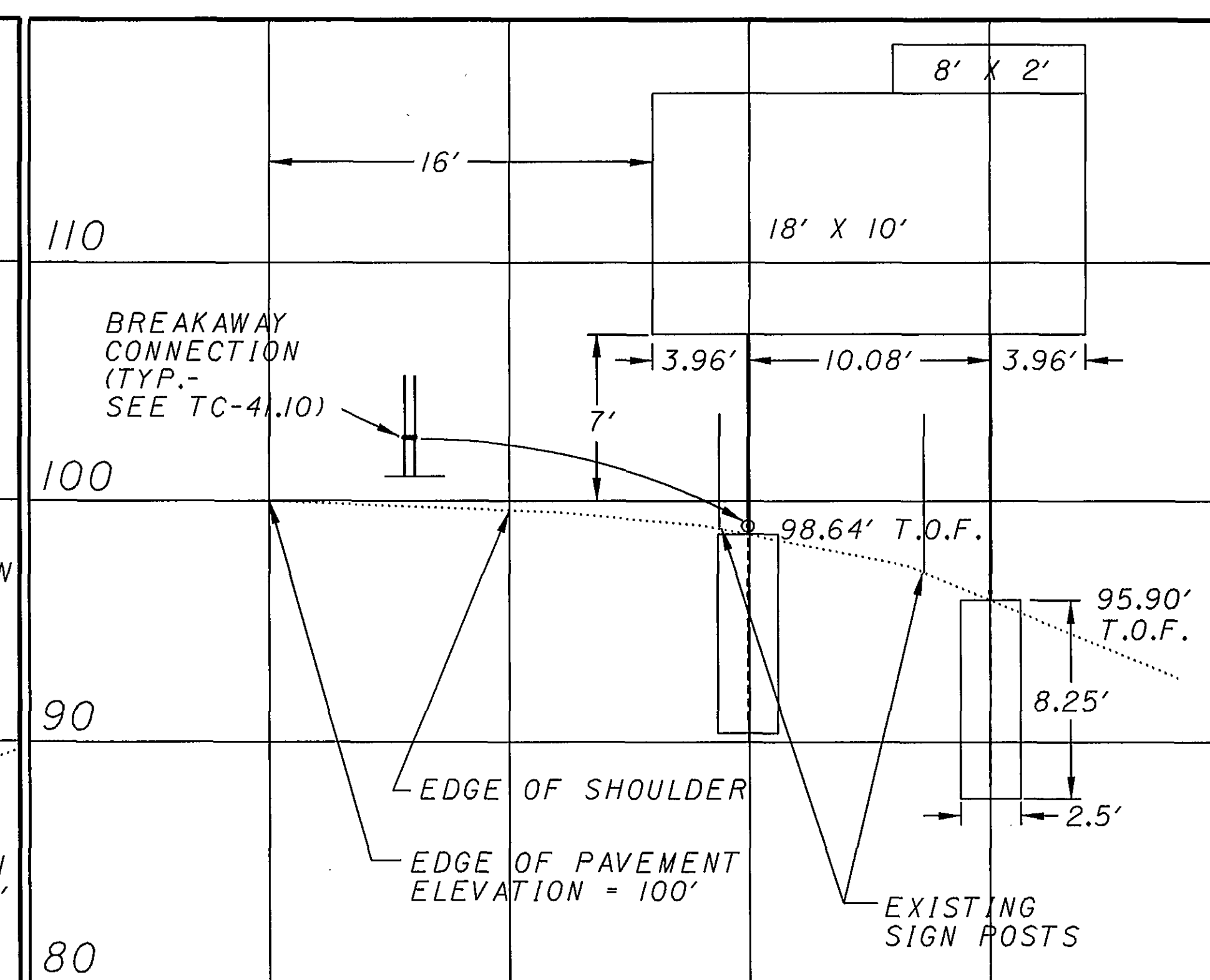

MILE 140.583, IR 70 EB
W12X30, 27'-30'
SHEET 49, S7

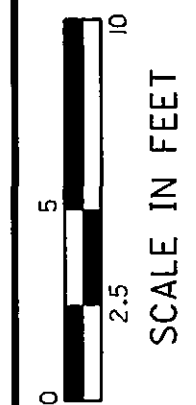

CALCULATED
DCB
CHECKED
KO

SIGN ELEVATIONS

D05-SIGN-FY2005

161
166

08/25/2004 10:48:36 AM M:\p\proj\0221\0505\22 Sign Inventory\Project plans\sheet\td005170.dgn

T.O.F. = TOP OF FOUNDATION ELEVATION

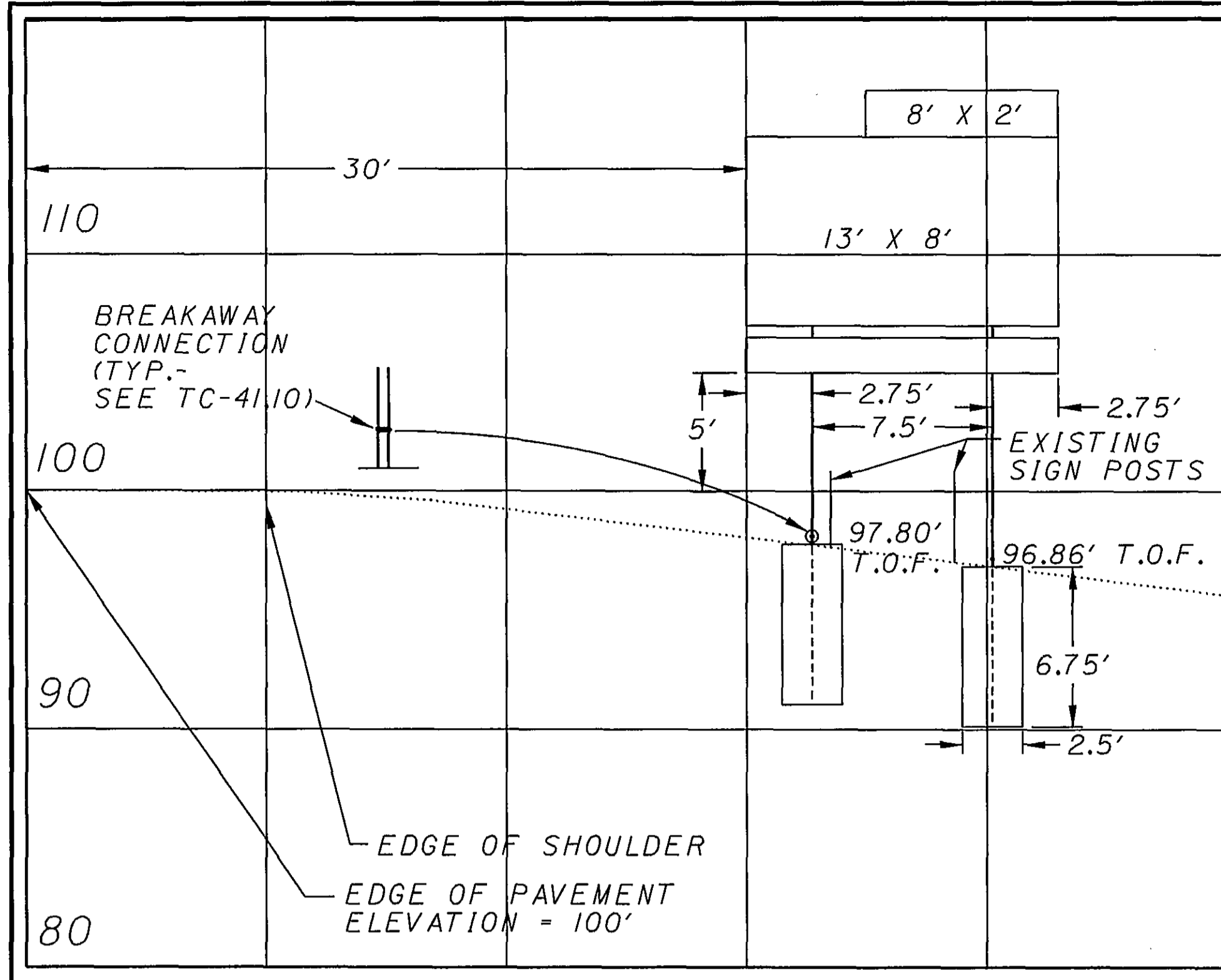

0 10 20 30 40
 MILE 143.320, IR 70 WB
 W10X22, 24'-25'
 SHEET 54, S2

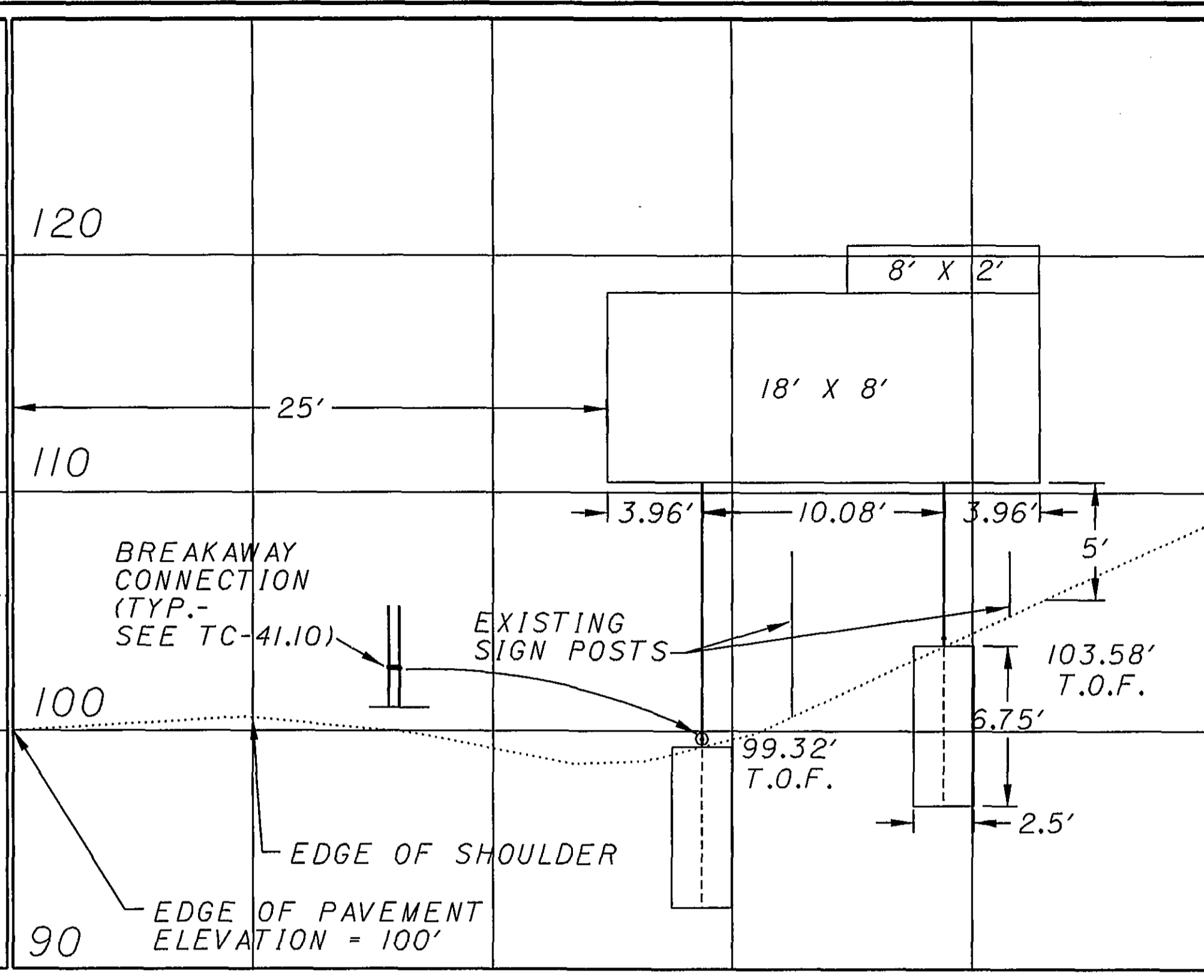

0 10 20 30 40
 MILE 152.704, IR 70 WB
 W10X22, 26'-22'
 SHEET 66, S2

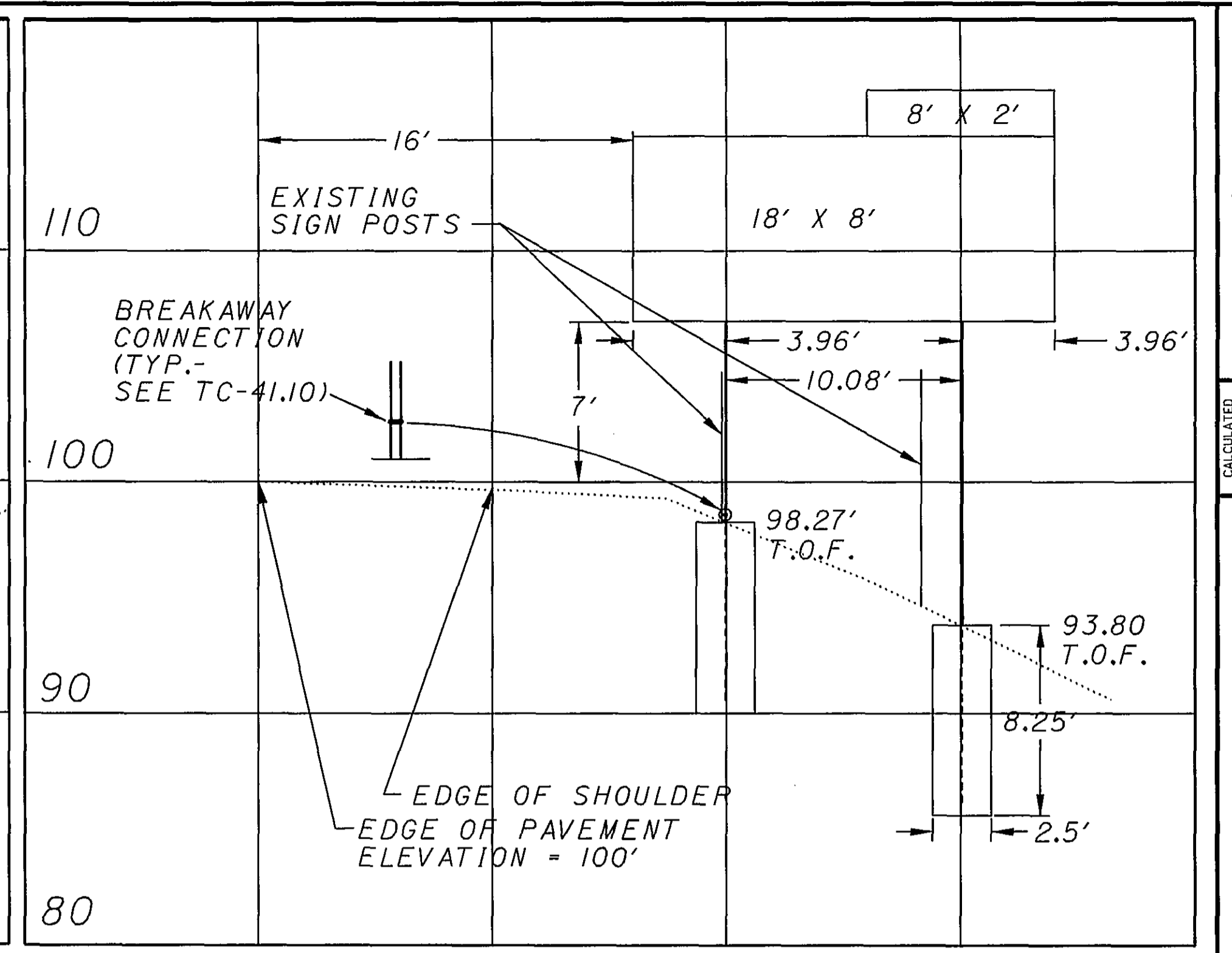

0 10 20 30
 MILE 156.835, IR 70 WB
 W12X30, 25'-29'
 SHEET 77, S11

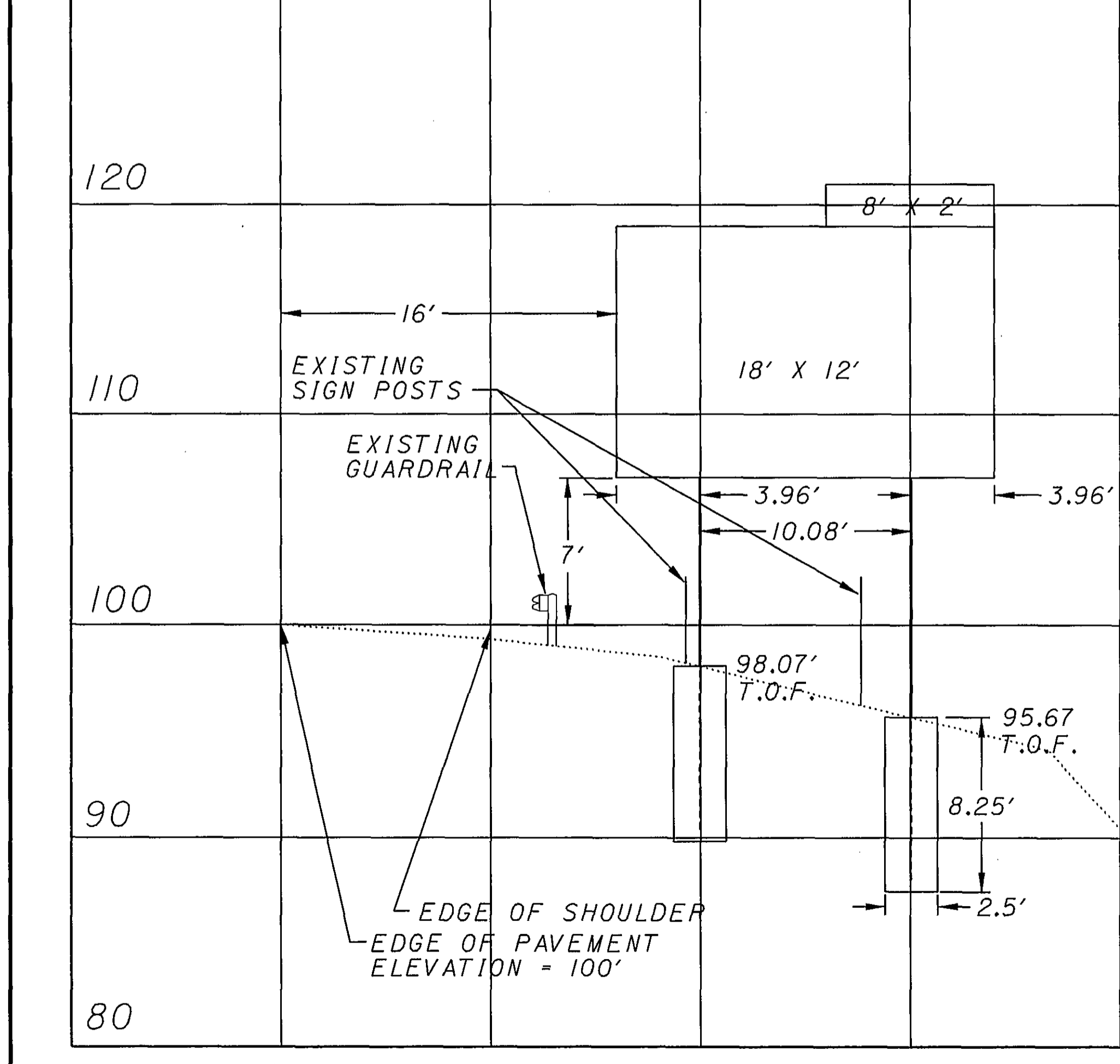

0 10 20 30
 T.O.F. = TOP OF FOUNDATION ELEVATION
 MILE 157.555, IR 70 WB
 W12X30, 29'-31', SHEET 80, S2

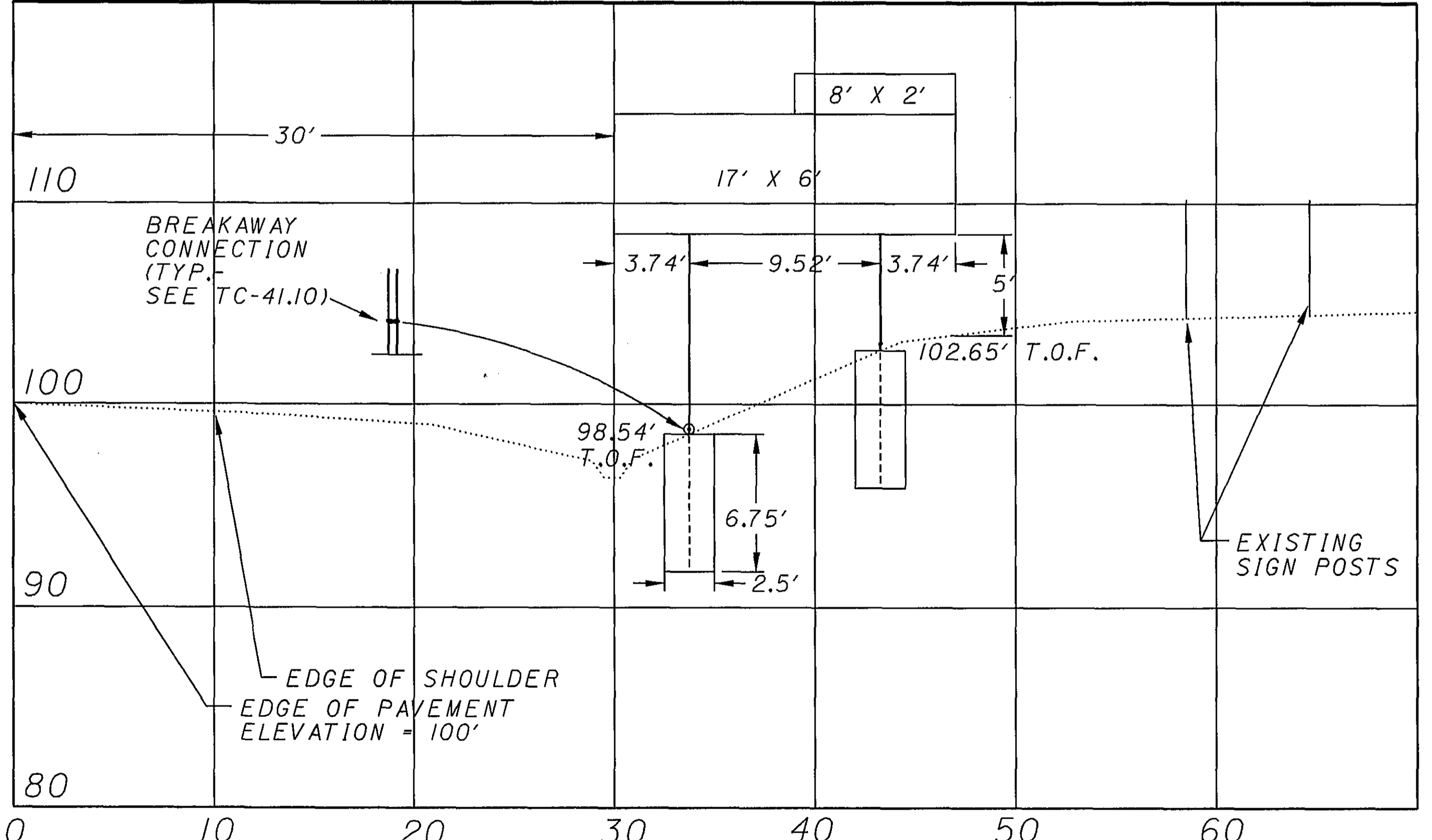

0 10 20 30 40 50 60
 MILE 160.289, IR 70 WB
 W10X22, 23'-19', SHEET 83, S3

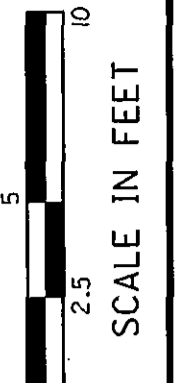

CALCULATED
 DCB
 CHECKED
 KO

SIGN ELEVATIONS

D05-SIGN-FY2005

162
 166

08/25/2004 10:47:47 AM
 M:\p\proj\02\1505\22 Sign Inventory\project plans\sheets\td006f70.dgn

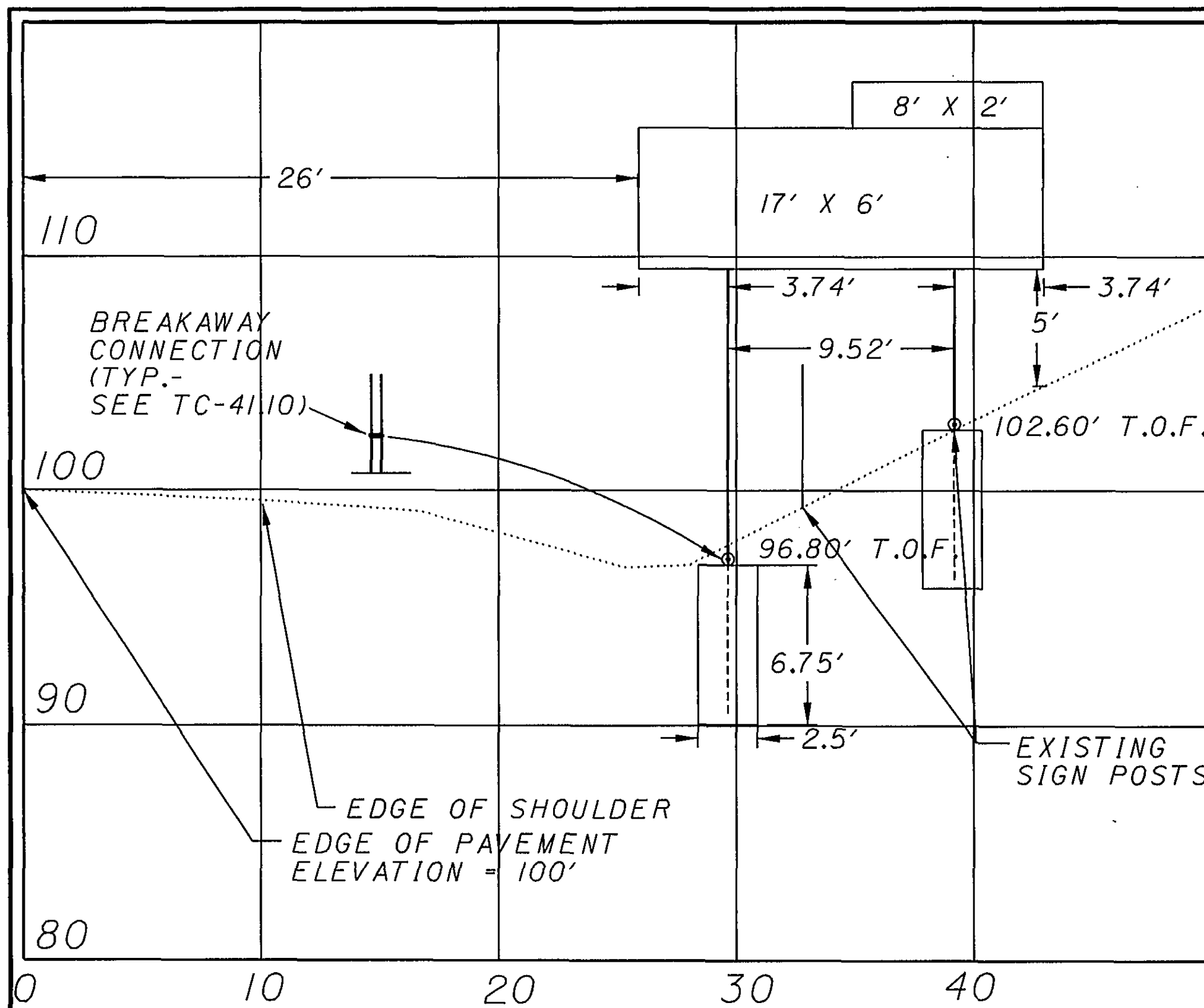

MILE 161.025, IR 70 WB
W10X22, 26'-20'
SHEET 86, S2

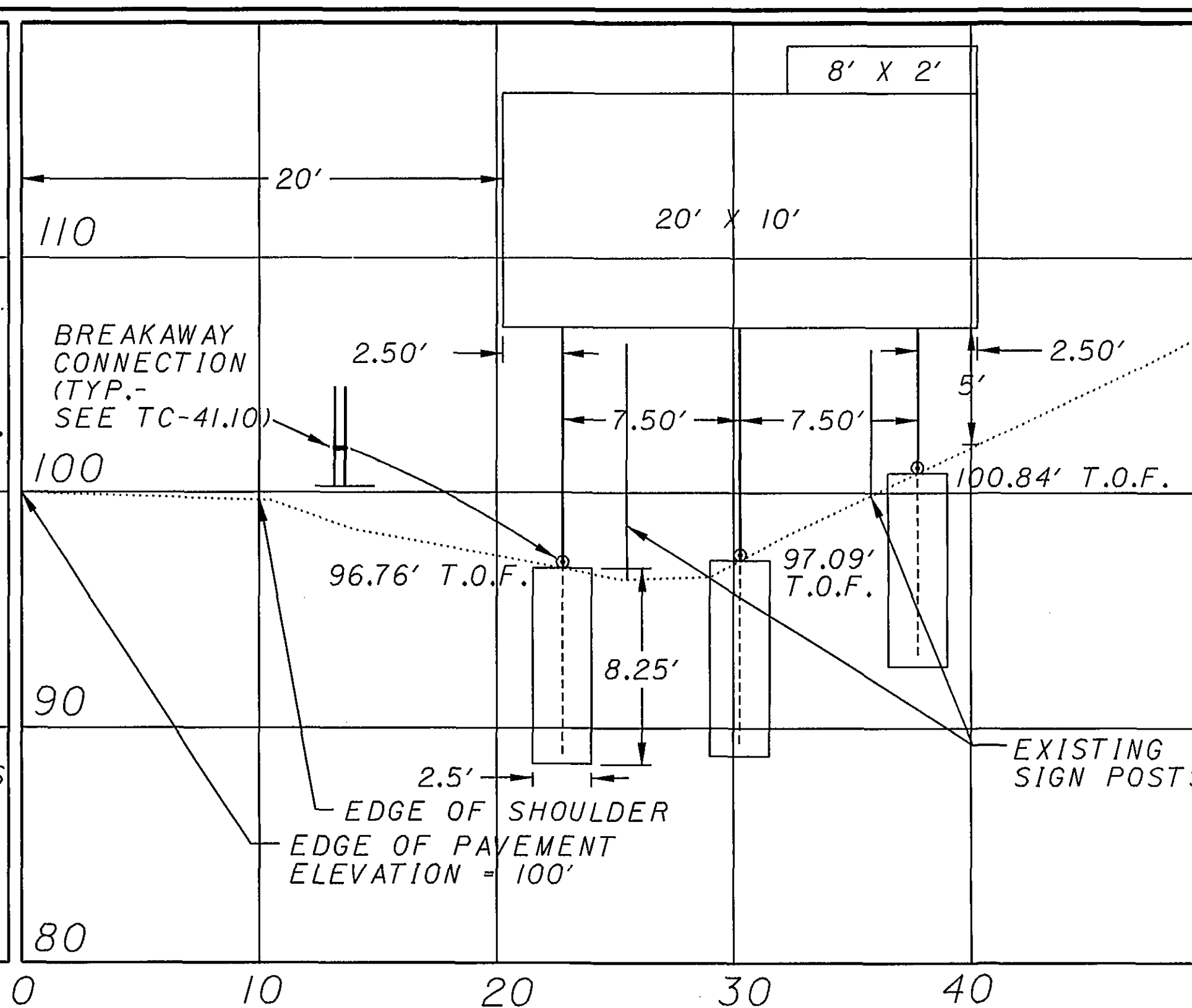

MILE 169.543, IR 70 EB
W12X30, 29'-28'-24'
SHEET 98, S1

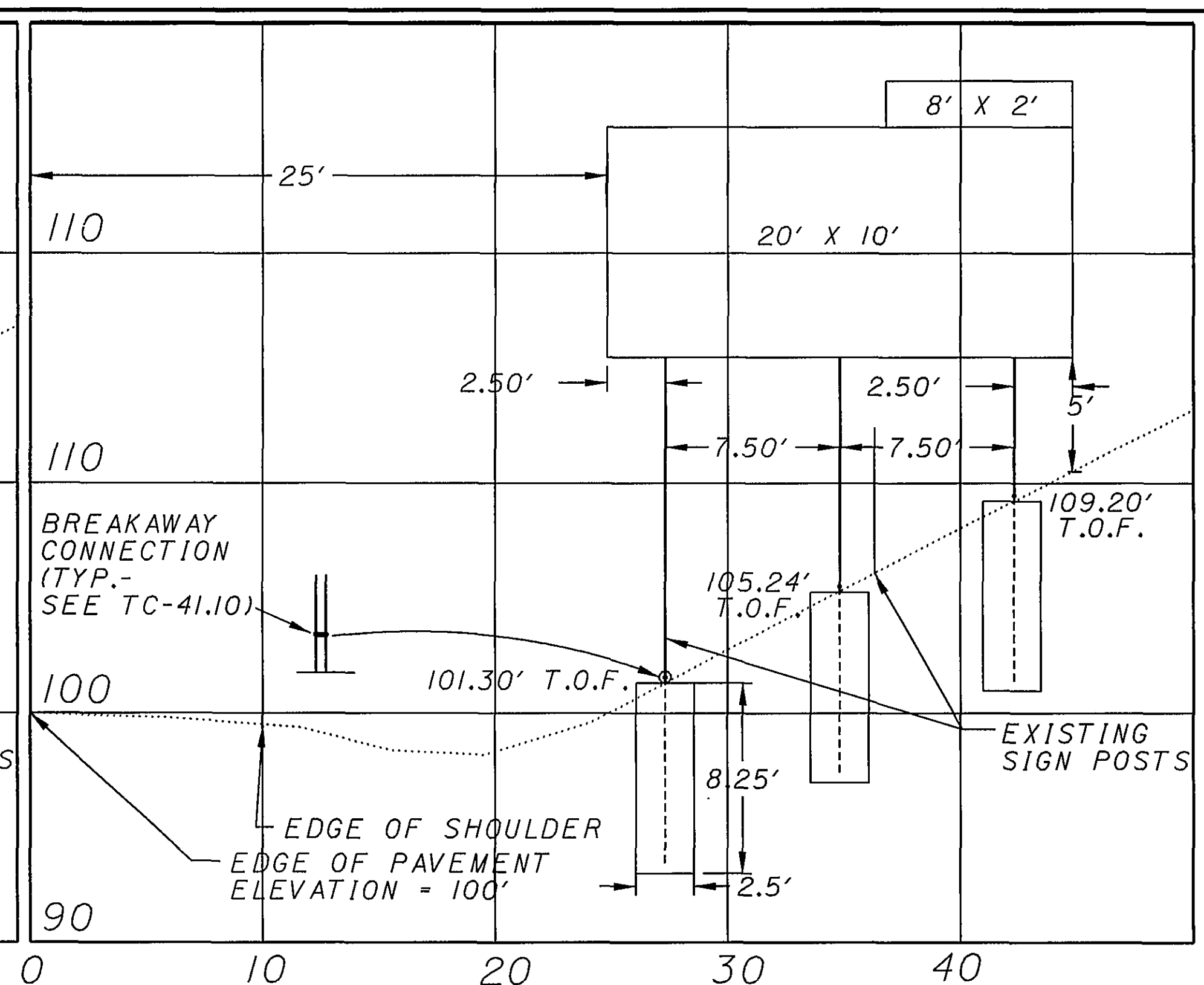

MILE 170.182, IR 70 WB
W12X30, 33'-29'-25'
SHEET 99, S3

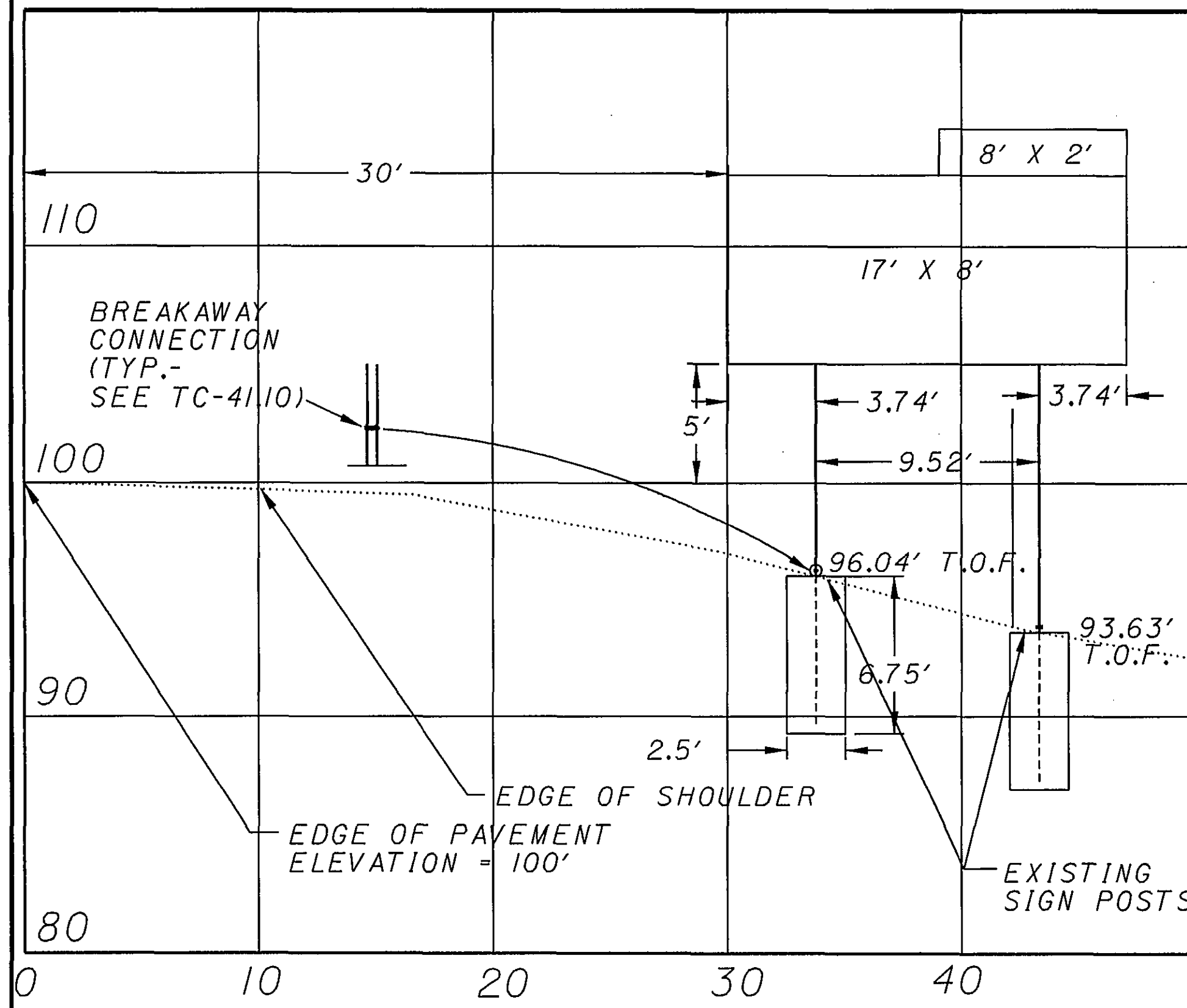

MILE 175.831, IR 70 EB
W10X22, 24'-26'
SHEET 104, S11

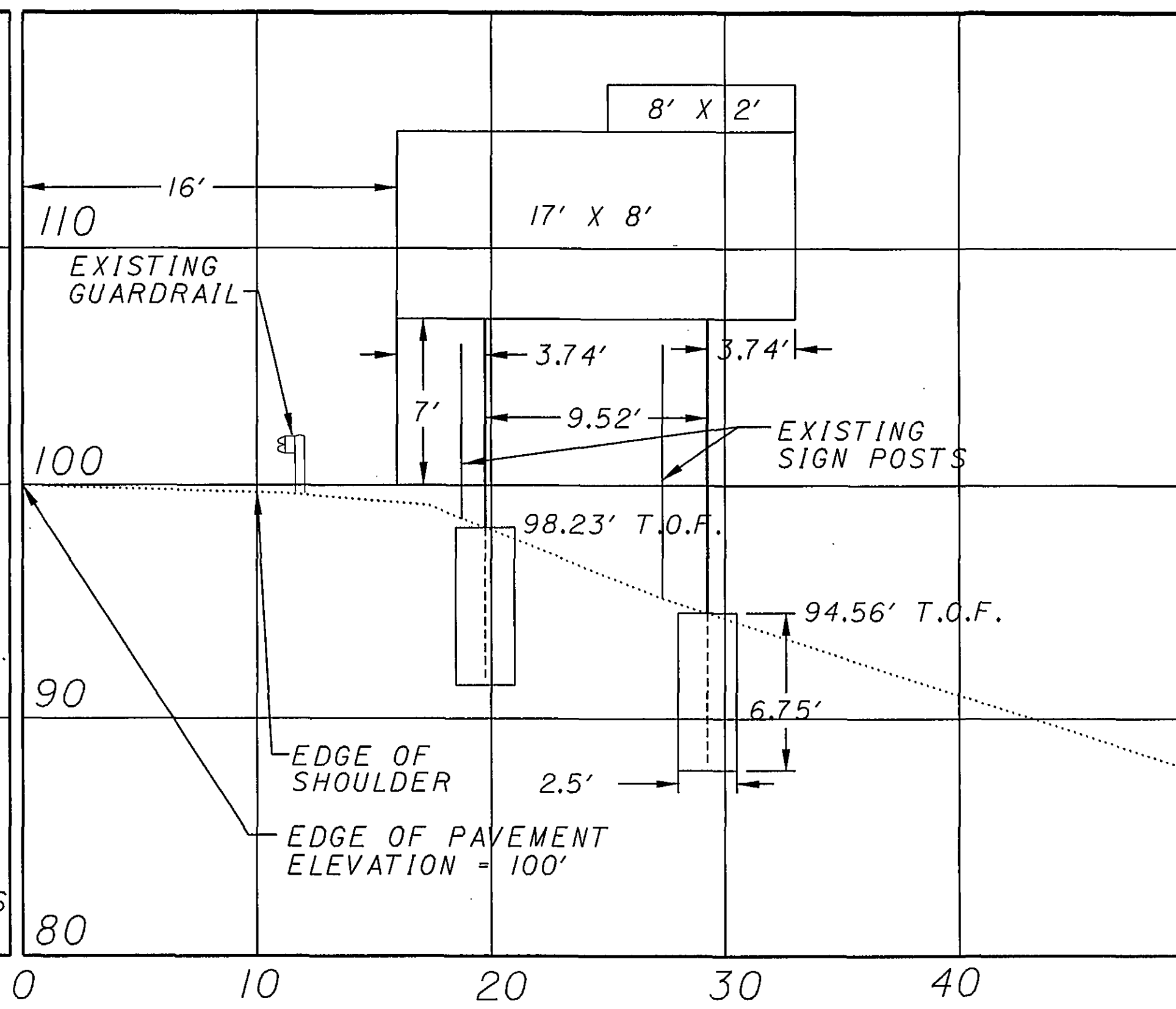

MILE 176.620, IR 70 WB
W10X22, 24'-27'
SHEET 107, S2

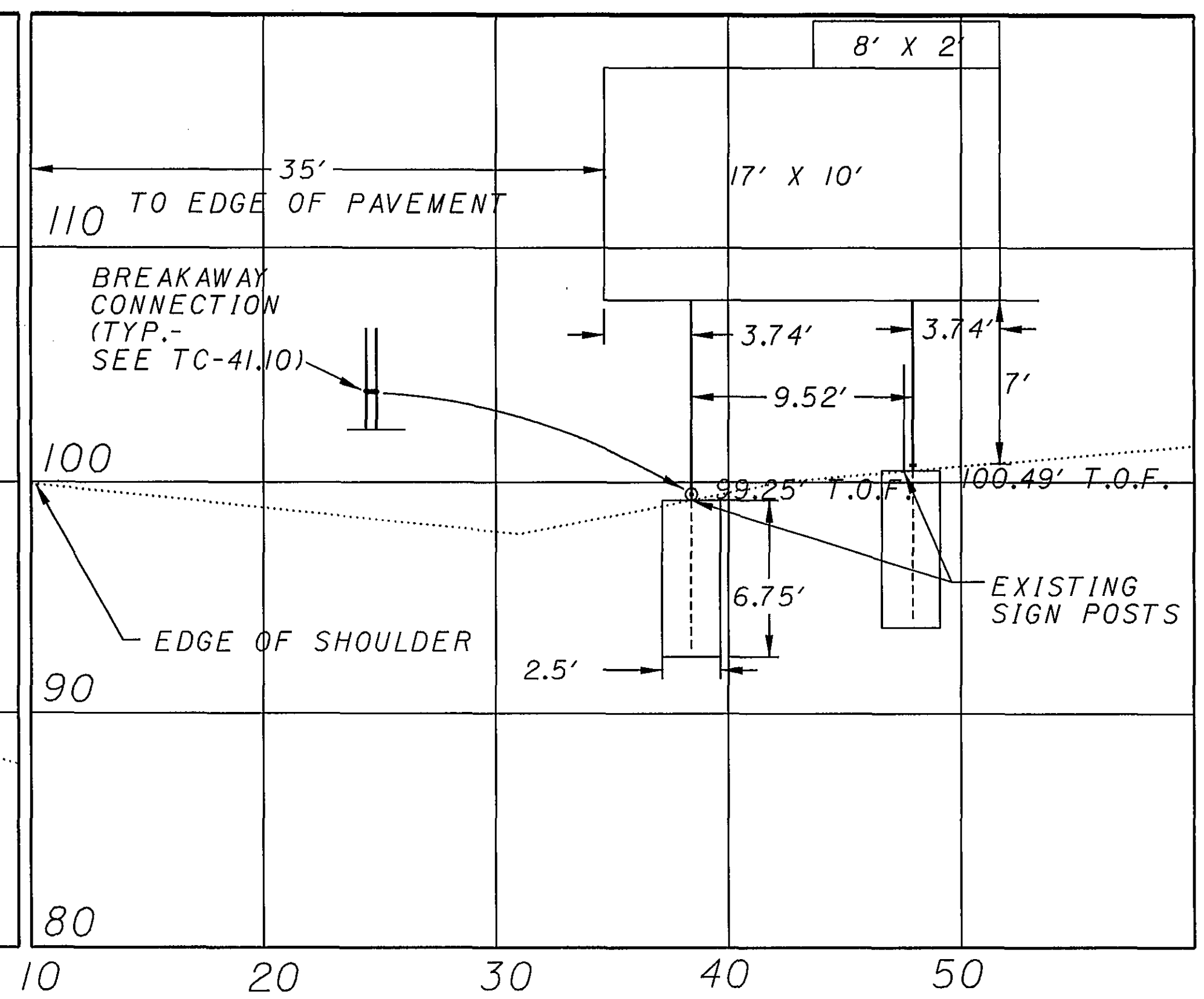

MILE 178.383, IR 70 EB
W10X22, 26'-25'
SHEET 108, S12

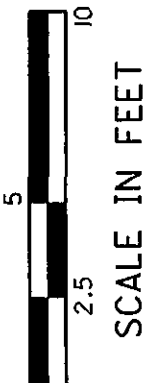

CALCULATED
SGG
DESIGNED
DCB

SIGN ELEVATIONS

D05-SIGN-FY2005

08/25/2004 10:46:52 AM M:\p\p\1022\1505\22 Sign Inventory\Project plans\sheets\1d007170.dgn

T.O.F. = TOP OF FOUNDATION ELEVATION

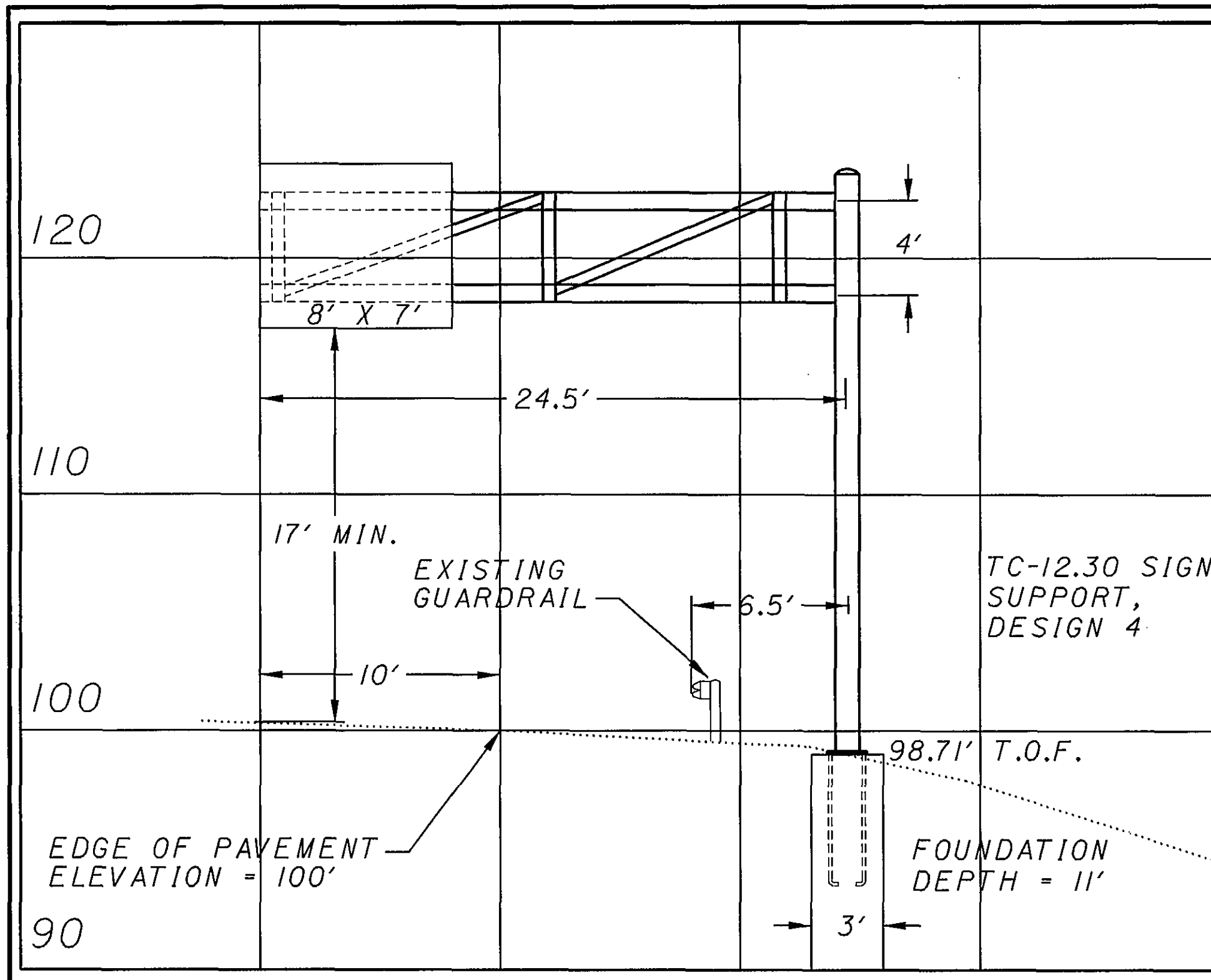

MILE 10.810, SR 209 NB
TC-12.30, DESIGN 4
SHEET 110, S24

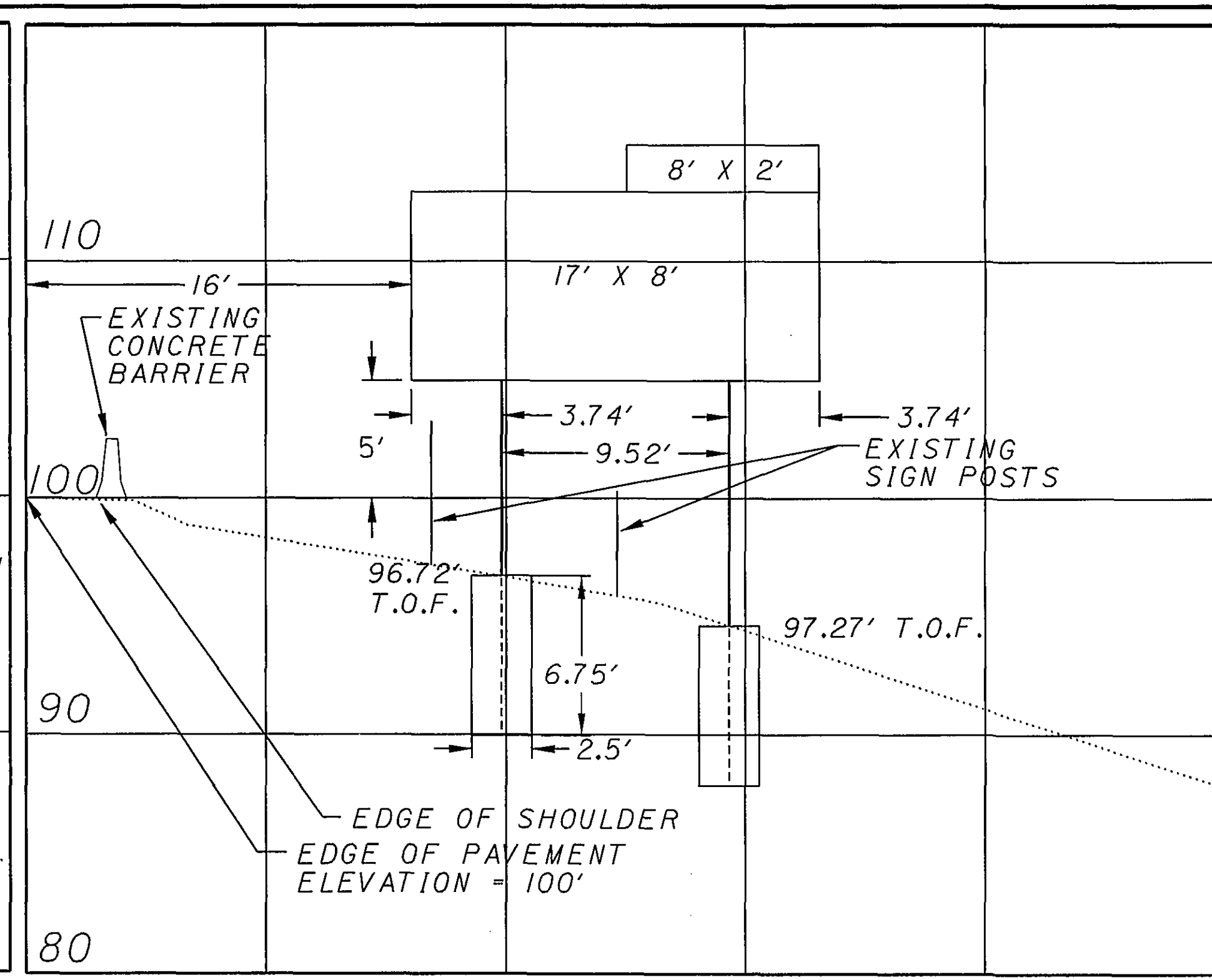

MILE 179.110, IR 70 WB
W10X22, 23'-25'
SHEET III, S2

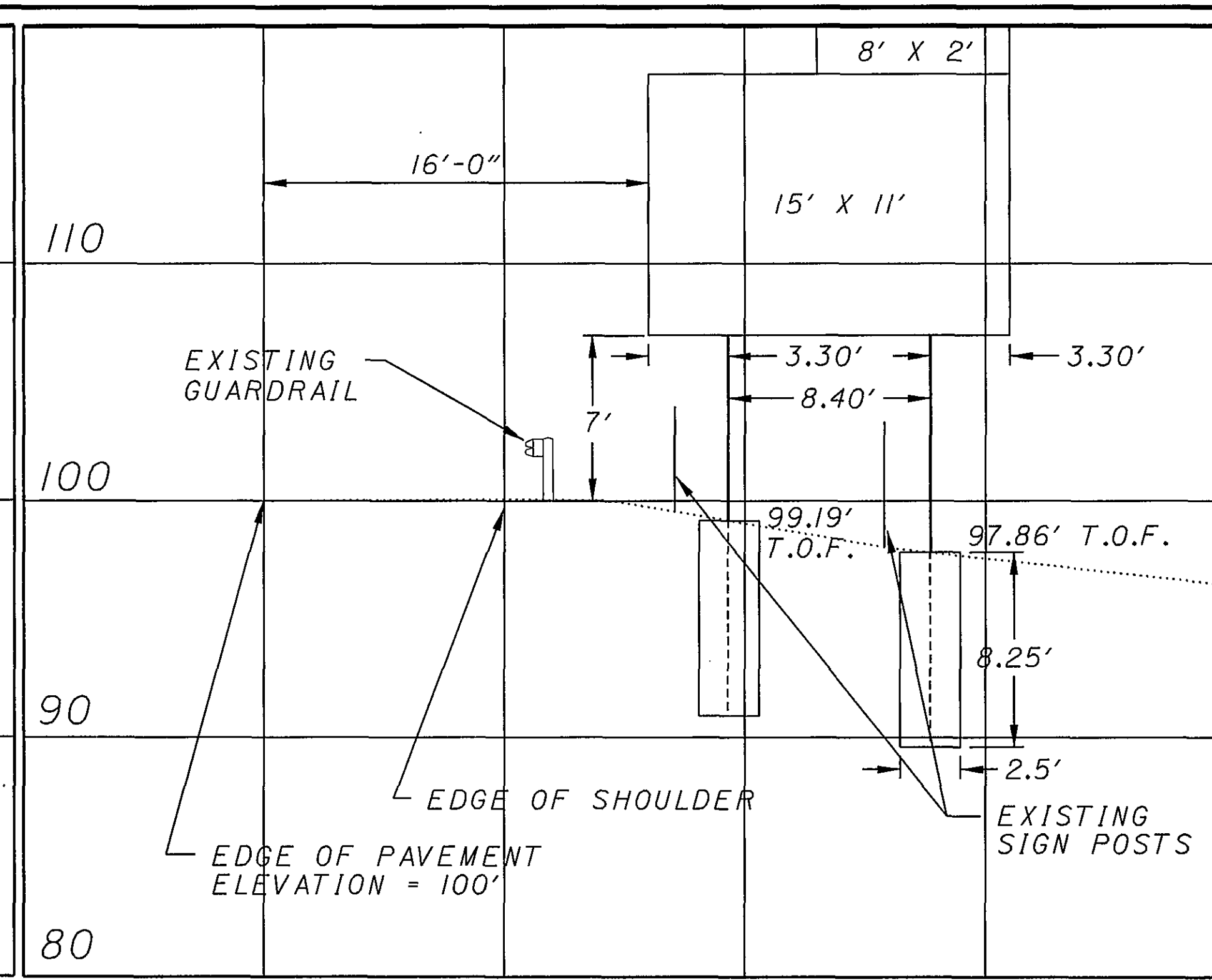

MILE 179.432, IR 70 EB
W12X30, 27'-29'
SHEET III, S3

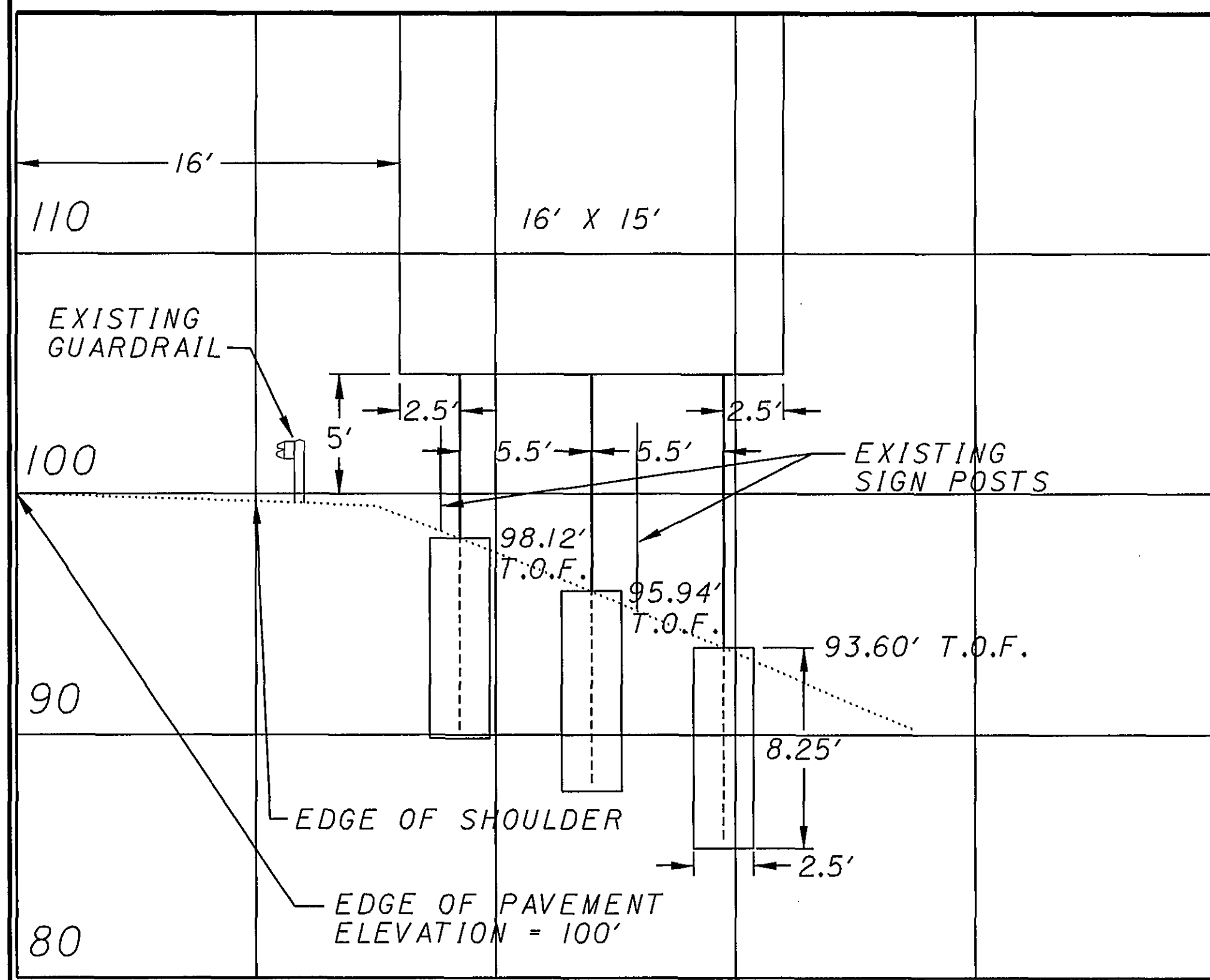

MILE 181.170, IR 70 WB
W12X30, 30'-33'-35'
SHEET 115, S3
T.O.F. = TOP OF
FOUNDATION ELEVATION

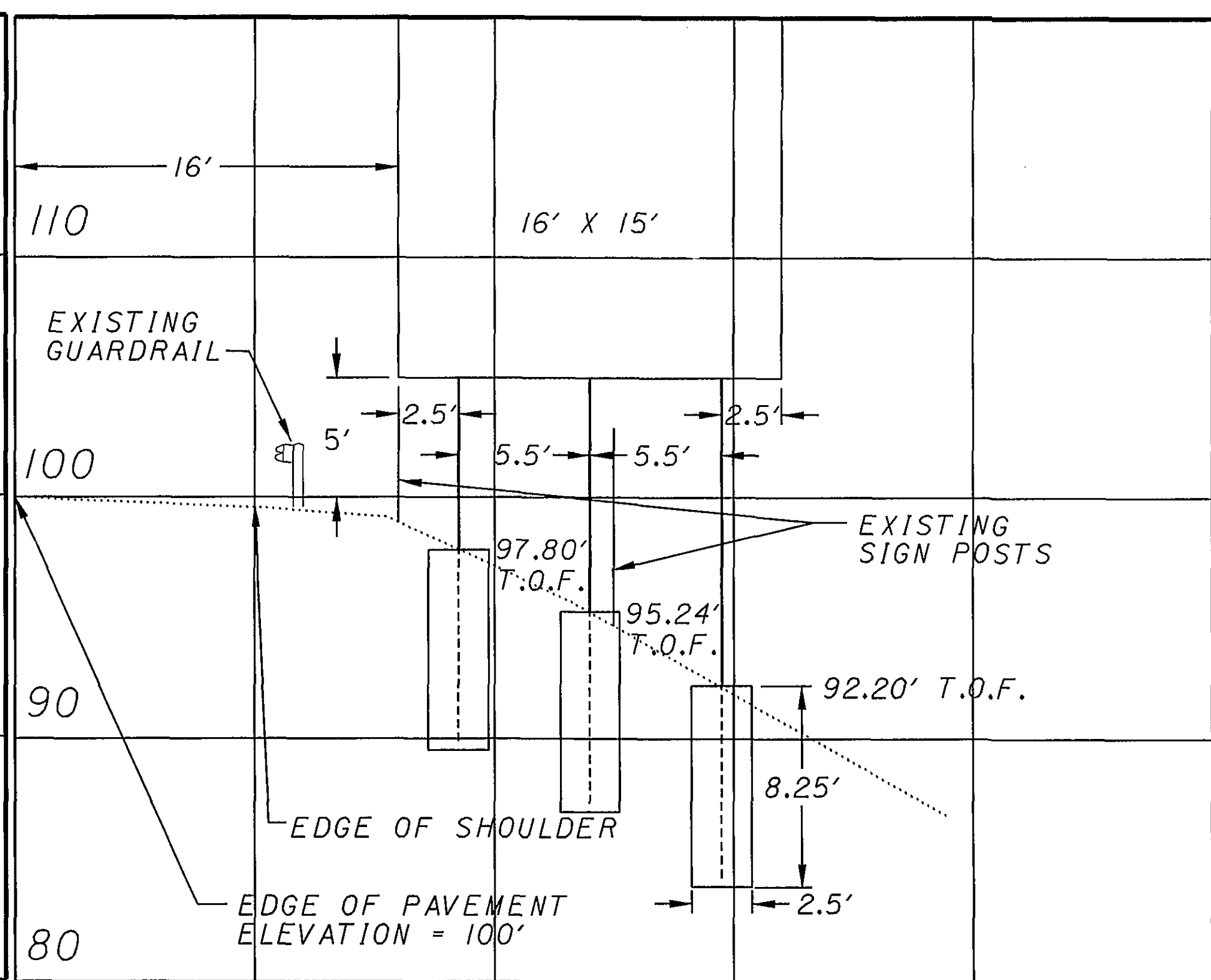

MILE 182.166, IR 70 WB
W12X30, 31'-33'-36'
SHEET 116, S2

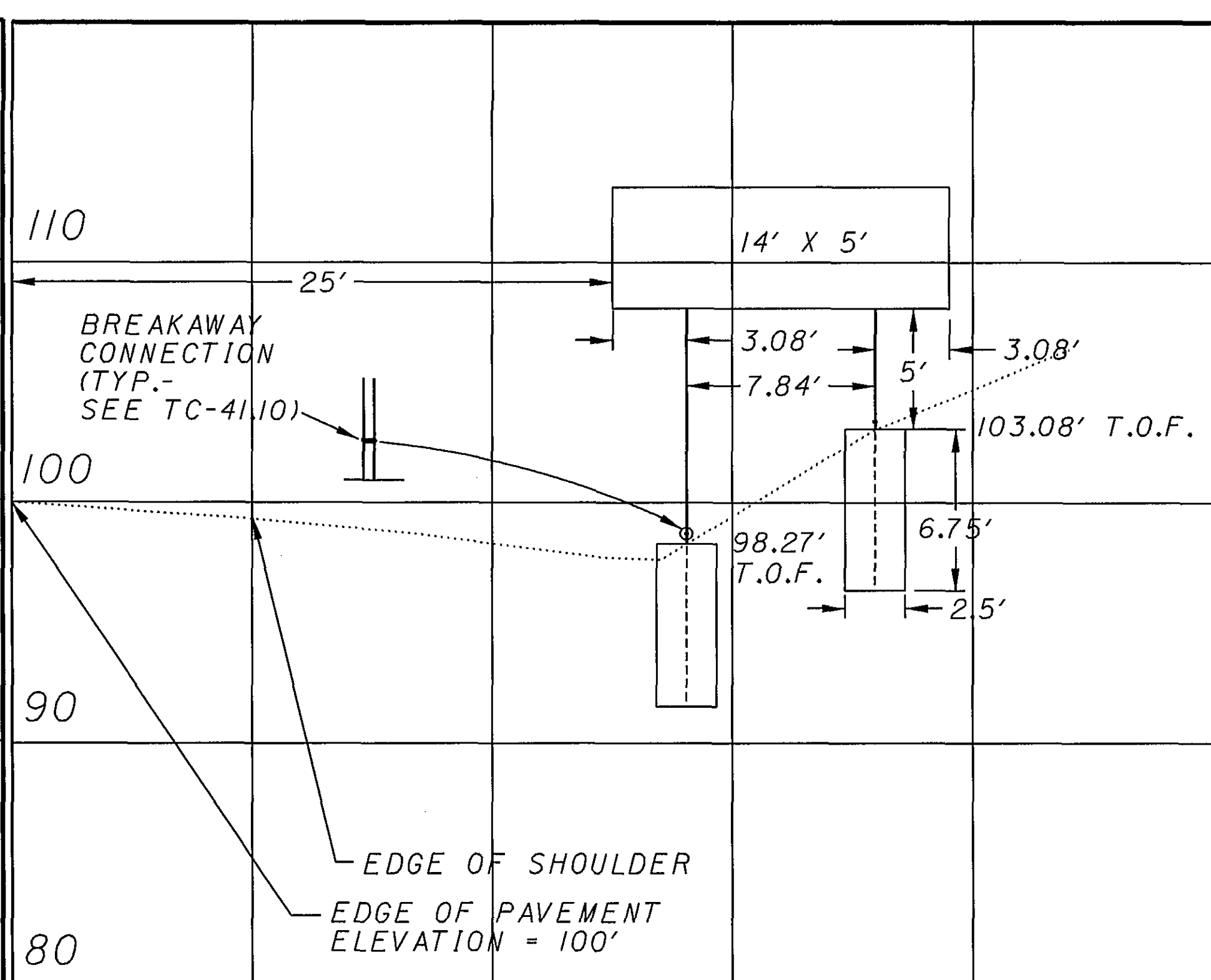

MILE 187.900, IR 70 WB
W10X22, 22'-17'
SHEET 123, S17

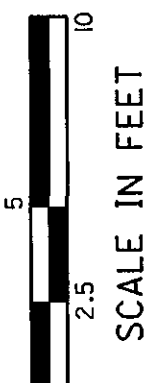

DCB
CHECKED
KO

SIGN ELEVATIONS

D05 - SIGN - FY 2005

164
166

08/25/2004 10:16:02 AM M:\proj\0221\0505\22 Sign Inventory\project plans\sheet\1008170.dgn

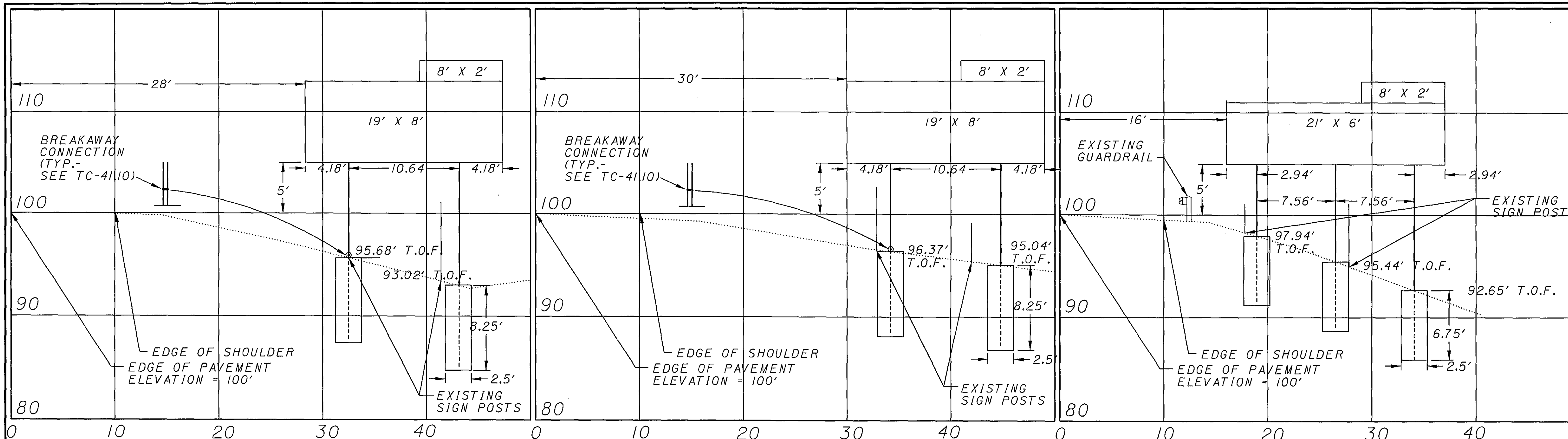

MILE 193.052, IR 70 EB
 W12X30, 26'-28'
 SHEET 129, S1

MILE 193.729, IR 70 WB
 W12X30, 25'-26'
 SHEET 129, S6

MILE 198.375, IR 70 EB
 W10X22, 20'-22'-25'
 SHEET 136, S3

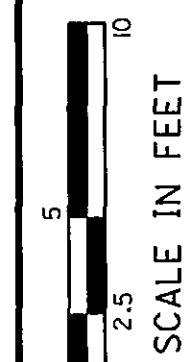

CALCULATED
 SCG
 CHECKED
 DCB

SIGN ELEVATIONS

D05-SIGN-FY2005

165
 166

08/25/2004 10:08:06 AM M:\proj\022\1505\22 Sign Inventory\project plans\sheets\1d009170.dgn

T.O.F. = TOP OF FOUNDATION ELEVATION

