

d:\va\vaip\wint01\parsons.com\Ohio State\Documents\Akron Beltway Rehab\10 - Design\102329\MOT\Sheets\BU-05\102329_GTBUS001.dgn Sheet 9/28/2021 12:56:38 PM aplilpchuk

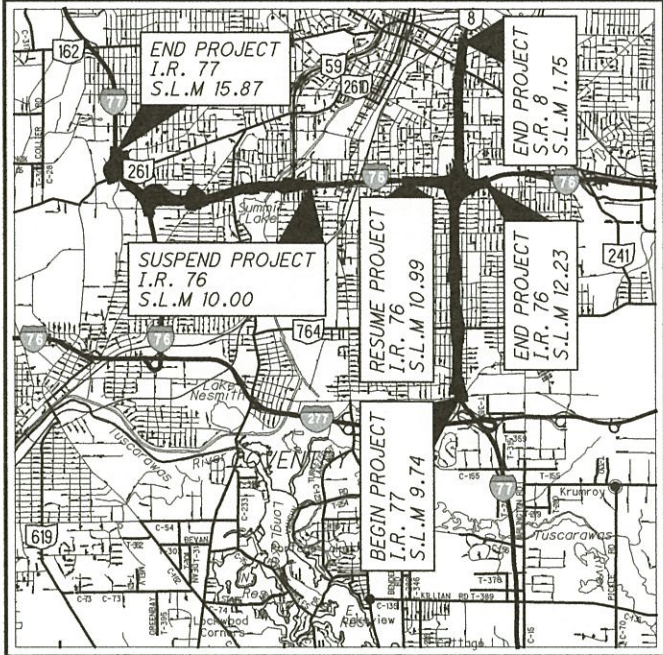

LOCATION MAP

LATITUDE: 41° 03' 43" LONGITUDE: 81° 30' 17"

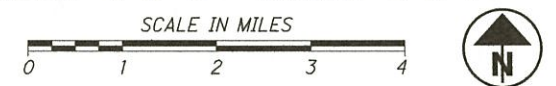

PORTION TO BE IMPROVED	=====
INTERSTATE HIGHWAY	=====
FEDERAL ROUTES	=====
STATE ROUTES	=====
COUNTY & TOWNSHIP ROADS	=====
OTHER ROADS	=====

DESIGN DESIGNATION

ROADWAY PLANS: SEE BU-29, 34, AND 33B

NHS PROJECT ----- YES

DESIGN EXCEPTIONS

N/A

UNDERGROUND UTILITIES
 Contact Two Working Days Before You Dig

OHIO811.org
Before You Dig

OHIO811, 8-1-1, or 1-800-362-2764
 (Non-members must be called directly)

PLAN PREPARED BY:

AMERICAN STRUCTUREPOINT INC.
 2550 CORPORATE EXCHANGE DR, STE 300
 COLUMBUS, OH 43231
 TEL 614.901.2235 FAX 614.901.2236
 www.structurepoint.com

ENGINEERS SEAL:

SIGNED: *[Signature]*
 DATE: 9/29/21

STANDARD CONSTRUCTION DRAWINGS				SUPPLEMENTAL SPECIFICATIONS	SPECIAL PROVISIONS
MT-95.40	1/17/20	MT-101.80	1/17/20	800-2019	10/16/20
MT-95.50	7/21/17	MT-101.90	7/17/20	821	4/20/12
MT-95.70	1/17/20	MT-102.10	1/17/20	829	1/20/17
MT-95.72	1/17/20	MT-103.10	1/19/18	831	10/21/16
MT-95.73	1/17/20	MT-105.10	1/17/20	839	1/17/20
MT-98.10	1/17/20				
MT-98.11	1/17/20	DM-1.3	7/18/14		
MT-98.21	1/17/20				
MT-98.29	1/17/20				
MT-99.30	1/17/20				
MT-99.50	1/17/20				
MT-99.60	7/15/16				
MT-100.00	1/15/16				
MT-101.60	1/17/20				
MT-101.70	1/17/20				
MT-101.75	1/17/20				

STATE OF OHIO
 DEPARTMENT OF TRANSPORTATION

SUM-76-8.24 SUM-77-9.74 SUM-8-0.00

CITY OF AKRON
 SUMMIT COUNTY

INDEX OF SHEETS:

TITLE SHEET	1
MOT NOTES	2-9
DETOUR PLANS	10-18
MAINTENANCE OF TRAFFIC	19-105

Released for Construction
 Thomas J Powell, PE
 10/04/2021

ISSUE RECORD:

NO.	DATE	DESCRIPTION

PROJECT DESCRIPTION

THE AKRON CENTRAL INTERCHANGE PROJECT (PID 102329) INCLUDES RECONSTRUCTION OF IR-76 EB/WB PAVEMENT FROM SLM 11.05 (IR-76) TO SLM (IR-76) FOR APPROX. 1.16 MILES OF MAINLINE WORK. THIS PROJECT ALSO INCLUDES REPLACEMENT OF TWO FREEWAY STRUCTURES (RAMP N AND RAMP O) ON NEW ALIGNMENTS, WIDENING OF TWO EXISTING BRIDGES (IR-76 EB OVER BROWN STREET AND IR-76 WB OVER INMAN STREET), CONSTRUCTION OF A NEW PEDESTRIAN/MULTI-USE OVERPASS SPANNING SR-8, AND CONSTRUCTION OF NOISE BARRIERS AT THE PERIMETER OF THE INTERCHANGE. PORTIONS OF SR-8, LANE O AND LANE S ARE TO BE RESURFACED. THE EXISTING IR-76 WB TO INMAN STREET AND IR-77 SB TO LOVERS LANE WILL BE REMOVED PERMANENTLY, AS WELL AS THE EXISTING LAFOLLETTE STREET BRIDGE OVER SR-8 (SUM-77-1184).

BUILDABLE UNIT 5 DESCRIPTION

THIS BUILDABLE UNIT SHOWS CONSTRUCTION OF IR 76/77 FROM SOUTH OF EAST AVENUE TO PRINCETON STREET AND FROM SOUTH OF GRANT STREET THROUGH THE CENTRAL INTERCHANGE. THE CONSTRUCTION ALSO INCLUDES IR 76 FROM THE CENTRAL INTERCHANGE TO EAST OF INMAN STREET.

LIMITED ACCESS

THIS IMPROVEMENT IS ESPECIALLY DESIGNED FOR THROUGH TRAFFIC AND HAS BEEN DECLARED A LIMITED ACCESS HIGHWAY OR FREEWAY BY ACTION OF THE DIRECTOR IN ACCORDANCE WITH THE PROVISIONS OF SECTION 5511.02 OF THE OHIO REVISED CODE.

2019 SPECIFICATIONS

THE STANDARD SPECIFICATIONS OF THE STATE OF OHIO, DEPARTMENT OF TRANSPORTATION, INCLUDING SUPPLEMENTAL SPECIFICATIONS LISTED IN THE PLANS AND CHANGES LISTED IN THE PROPOSAL SHALL GOVERN THIS IMPROVEMENT.

BU-05
MOT

I-77/76 East Ave to
 I-76 Holy Cross Blvd

RFC PLANS
SEPTEMBER 29, 2021

2021-09-29 - BU 05 - RELEASED FOR CONSTRUCTION PLANS

FEDERAL PROJECT NO. **E180(428)**
 PID NO. **102329**
 CONSTRUCTION PROJECT NO. **21-3000**
 RAILROAD INVOLVEMENT **NONE**

SUM-76/77/8-8.24/9.74/0.00

1/105

ITEM 614, MAINTAINING TRAFFIC

A MINIMUM OF TWO LANES OF TRAFFIC IN EACH DIRECTION SHALL BE MAINTAINED AT ALL TIMES BY USE OF THE EXISTING PAVEMENT, THE COMPLETED PAVEMENT, ITEM 502 STRUCTURE FOR MAINTAINING TRAFFIC, ITEM 615 PAVEMENT FOR MAINTAINING TRAFFIC, ITEM 615 ROADS FOR MAINTAINING TRAFFIC, AND TEMPORARY SURFACES USING ITEMS 410 AND 614.

A MINIMUM OF TWO LANES OF TRAFFIC IN EACH DIRECTION SHALL BE MAINTAINED AT ALL TIMES. A DISINCENTIVE SHALL BE ASSESSED IN THE AMOUNT OF \$3,000 PER HOUR FOR EACH HOUR THE ROADWAY REMAINS CLOSED TO TRAFFIC BEYOND THE SPECIFIED LIMIT.

LENGTH AND DURATION OF LANE CLOSURES AND RESTRICTIONS SHALL BE AT THE APPROVAL OF THE ENGINEER. IT IS THE INTENT TO MINIMIZE THE IMPACT TO THE TRAVELING PUBLIC. LANE CLOSURES OR RESTRICTIONS OVER SEGMENTS OF THE PROJECT IN WHICH NO WORK IS ANTICIPATED WITHIN A REASONABLE TIME FRAME, AS DETERMINED BY THE ENGINEER, SHALL NOT BE PERMITTED. THE LEVEL OF UTILIZATION OF MAINTENANCE OF TRAFFIC DEVICES SHALL BE COMMENSURATE WITH THE WORK IN PROGRESS.

NO WORK SHALL BE PERFORMED AND ALL EXISTING LANES SHALL BE OPEN TO TRAFFIC DURING THE FOLLOWING DESIGNATED HOLIDAYS OR EVENTS:

CHRISTMAS	FOURTH OF JULY
NEW YEARS	LABOR DAY
MEMORIAL DAY	THANKSGIVING
EASTER	

THE PERIOD OF TIME THAT THE LANES ARE TO BE OPEN DEPENDS ON THE DAY OF THE WEEK ON WHICH THE HOLIDAY OR EVENT FALLS. THE FOLLOWING SCHEDULE SHALL BE USED TO DETERMINE THIS PERIOD:

DAY OF HOLIDAY OR EVENT	TIME ALL LANES MUST BE OPEN FOR TRAFFIC
SUNDAY	12:00N FRIDAY THROUGH 6:00 AM MONDAY
MONDAY	12:00N FRIDAY THROUGH 6:00 AM TUESDAY
TUESDAY	12:00N MONDAY THROUGH 6:00 AM WEDNESDAY
WEDNESDAY	12:00N TUESDAY THROUGH 6:00 AM THURSDAY
THURSDAY	12:00N WEDNESDAY THROUGH 6:00 AM FRIDAY
THURSDAY (THANKSGIVING ONLY)	6:00 AM WEDNESDAY THROUGH 6:00 AM MONDAY
FRIDAY	12:00N THURSDAY THROUGH 6:00 AM MONDAY
SATURDAY	12:00N FRIDAY THROUGH 6:00 AM MONDAY

SHOULD THE CONTRACTOR FAIL TO MEET ANY OF THESE REQUIREMENTS, THE CONTRACTOR SHALL BE ASSESSED A DISINCENTIVE PER THE LANE VALUE CONTRACT.

NOTICE OF CLOSURE SIGNS (W20-H13) SHALL BE ERECTED BY THE CONTRACTOR PRIOR TO THE SCHEDULED ROAD OR RAMP CLOSURE IN ACCORDANCE WITH THE NOTICE OF CLOSURE TIME TABLE BELOW. AT THE APPROVAL OF THE ENGINEER, PORTABLE CHANGEABLE MESSAGE SIGNS MAY BE USED IN LIEU OF THE STANDARD FLATSHEET SIGN FOR CLOSURE DURATIONS OF LESS THAN 1 WEEK.

THE SIGNS SHALL BE ERECTED ON THE RIGHT-HAND SIDE OF THE ROAD/RAMP FACING TRAFFIC. THEY SHALL BE PLACED

ITEM 614, MAINTAINING TRAFFIC (CONT'D)

SO AS NOT TO INTERFERE WITH THE VISIBILITY OF ANY OTHER TRAFFIC CONTROL SIGNS. ON ROADWAYS, THEY SHOULD BE ERECTED AT OR NEAR THE POINT OF CLOSURE. THE SIGNS MAY BE ERECTED ANYWHERE ON RAMPS AS LONG AS THEY ARE VISIBLE TO THE MOTORISTS USING THE RAMP. ON ENTRANCE RAMPS, THE SIGN SHALL BE ERECTED WELL IN ADVANCE OF THE MERGE AREA TO AVOID DISTRACTING MOTORISTS.

NOTICE OF CLOSURE SIGN TIME TABLE		
ITEM	DURATION OF CLOSURE	SIGN DISPLAYED TO PUBLIC
RAMP & ROAD CLOSURES	>= 2 WEEKS	14 CALENDAR DAYS PRIOR TO CLOSURE
	> 12 HOURS & < 2 WEEKS	7 CALENDAR DAYS PRIOR TO CLOSURE
	< 12 HOURS	2 BUSINESS DAYS PRIOR TO CLOSURE

THE SIGN SHALL DISPLAY THE DATE OF THE CLOSURE IN MMM-DD FORMAT AND THE NUMBER OF DAYS OF THE CLOSURE. THE LAST LINE OF THE W20-H13 SIGN LISTS A PHONE NUMBER WHICH A MOTORIST MAY CALL FOR ADDITIONAL INFORMATION. THIS IS TO BE A SPECIFIC OFFICE WITHIN THE DISTRICT RATHER THAN THE GENERAL SWITCHBOARD NUMBER.

ALL WORK AND TRAFFIC CONTROL DEVICES SHALL BE IN ACCORDANCE WITH C&MS 614 AND OTHER APPLICABLE PORTIONS OF THE SPECIFICATIONS, AS WELL AS THE OHIO MANUAL OF UNIFORM TRAFFIC CONTROL DEVICES. PAYMENT FOR ALL LABOR, EQUIPMENT AND MATERIALS SHALL BE INCLUDED IN THE LUMP SUM CONTRACT PRICE FOR ITEM 614, MAINTAINING TRAFFIC, UNLESS SEPARATELY ITEMIZED IN THE PLAN.

ITEM 614 - MAINTENANCE OF TRAFFIC (RESTRICTIONS)

ALL EXISTING LANES OF TRAFFIC IN EACH DIRECTION SHALL BE MAINTAINED AT ALL TIMES, EXCEPT AS PERMITTED BY THE PERMITTED LANE CLOSURE TIMES NOTE AND THE MOTEC/PIAC APPROVED CLOSURES NOTE, BY USE OF THE EXISTING PAVEMENT, THE COMPLETED PAVEMENT, AND ITEM 615 PAVEMENT FOR MAINTAINING TRAFFIC CLASS A.

THE FOLLOWING CRITERIA SHALL BE USED IN DEVELOPMENT OF MAINTENANCE OF TRAFFIC PLANS FOR ALL ROADWAYS WITHIN THE PROJECT LIMITS:

MINIMUM LANE WIDTH: 11 FEET*
 MINIMUM BARRIER/CURB OFFSET: 2 FOOT*
 MINIMUM EDGE OF PAVEMENT OFFSET: 2 FEET

*THE MINIMUM BARRIER/CURB OFFSET MAY BE REDUCED TO 1 FOOT AND LANE WIDTH REDUCED TO 10 FEET WHEN NECESSARY IN SPOT LOCATIONS. SPOT LOCATIONS INCLUDE ON BRIDGE DECKS, ON APPROACH SLABS, BETWEEN BRIDGE PIERS AND ROADWAY SECTIONS WHERE TEMPORARY SLIVER FILLS COULD BE AVOIDED BY SAID ALLOWANCE. STANDARD TAPER RATES SHALL APPLY IN THE SHOULDER TRANSITION FROM 2 FOOT TO 1 FOOT; AND VICEVERSA.

BEFORE WORK BEGINS, THE CONTRACTOR SHALL SUBMIT TO THE ENGINEER THE NAME AND TELEPHONE NUMBER OF THE WORKSITE TRAFFIC SUPERVISOR(S) WHO CAN BE CONTACTED 24 HOURS A DAY BY THE OHIO DEPT. OF TRANSPORTATION AND ALL INTERESTED POLICE AGENCIES.

NOTIFICATION OF TRAFFIC RESTRICTIONS

Released for Construction
 Thomas J Powell, PE
 10/04/2021

THROUGHOUT THE DURATION OF THE PROJECT, THE CONTRACTOR SHALL NOTIFY THE PROJECT ENGINEER IN WRITING OF ALL TRAFFIC RESTRICTIONS AND UPCOMING MAINTENANCE OF TRAFFIC CHANGES. THE CONTRACTOR SHALL ENSURE THE WRITTEN NOTIFICATION IS SUBMITTED IN A TIMELY MANNER TO ALLOW THE PROJECT ENGINEER TO MEET THE REQUIRED TIME FRAMES SET FORTH IN THE TABLE BELOW TO INFORM SPECIAL HAULING PERMITS SECTION (HAULING.PERMITS@DOT.OHIO.GOV) AND THE DISTRICT PUBLIC INFORMATION OFFICE (PIO). THIS NOTIFICATION SHALL BE RECEIVED BY THE PROJECT ENGINEER PRIOR TO THE PHYSICAL SETUP OF ANY APPLICABLE SIGNS OR MESSAGE BOARDS.

INFORMATION SHOULD INCLUDE, BUT IS NOT LIMITED TO, ALL CONSTRUCTION ACTIVITIES THAT IMPACT OR INTERFERE WITH TRAFFIC AND SHALL LIST THE SPECIFIC LOCATION, TYPE OF WORK, ROAD STATUS, DATE AND TIME OF RESTRICTION, DURATION OF RESTRICTION, NUMBER OF LANES MAINTAINED, NUMBER OF LANES CLOSED, MINIMUM VERTICAL CLEARANCE, MINIMUM WIDTH OF DRIVABLE PAVEMENT, DETOUR ROUTES, IF APPLICABLE, AND ANY OTHER INFORMATION REQUESTED BY THE PROJECT ENGINEER.

NOTICE OF OFFICE OF COMMUNICATION TABLE		
ITEM	DURATION OF CLOSURE	NOTICE DUE TO PERMITS & PIO
RAMP & ROAD CLOSURES	>= 2 WEEKS	21 CALENDAR DAYS PRIOR TO CLOSURE
	> 12 HOURS & < 2 WEEKS	14 CALENDAR DAYS PRIOR TO CLOSURE
	<= 12 HOURS	4 BUSINESS DAYS PRIOR TO CLOSURE
LANE CLOSURES & RESTRICTIONS	>= 2 WEEKS	14 CALENDAR DAYS PRIOR TO CLOSURE
	< 2 WEEKS	5 BUSINESS DAYS PRIOR TO CLOSURE
START OF CONSTRUCTION & TRAFFIC PATTERN CHANGES	N/A	14 CALENDAR DAYS PRIOR TO CLOSURE

ANY UNFORESEEN CONDITIONS NOT SPECIFIED IN THE PLANS REQUIRING TRAFFIC RESTRICTIONS SHALL ALSO BE REPORTED TO THE PROJECT ENGINEER USING THE NOTIFICATION TIME TABLE.

DETOUR NOTIFICATION CITY OF AKRON/SUMMIT COUNTY

THE CONTRACTOR SHALL ADVISE THE ODOT DISTRICT OFFICE (330-786-3148) AND COUNTY/CITY EIGHTEEN (18) DAYS IN ADVANCE OF WHEN THE DETOUR ROUTE SHOULD BE IN EFFECT. ALL WORK ZONE DEVICES REQUIRED SHALL BE FURNISHED, ERECTED, MAINTAINED, AND SUBSEQUENTLY REMOVED BY THE CONTRACTOR. PAYMENT FOR ALL WORK ASSOCIATED WITH THE DETOUR SHALL BE INCLUDED UNDER THE LUMP SUM BID FOR ITEM 614, DETOUR SIGNING.

WORK ZONE EGRESS WARNING SYSTEM

THE CONTRACTOR SHALL FURNISH, INSTALL, AND MAINTAIN AN APPROVED WORK ZONE EGRESS WARNING SYSTEM (WZEWS) AS PER SUPPLEMENTAL SPECIFICATION 829.

THE PROBABLE INITIAL LOCATIONS OF THE WZEWS DEVICES ARE SHOWN IN THE PLAN. IT IS EXPECTED THAT THESE LOCATIONS WILL VARY BASED ON PLANNED OR UNPLANNED PHASE AND TRAFFIC PATTERN CHANGES. PLACEMENT, OPERATION, AND MAINTENANCE AND ALL ACTIVATION OF THE DEVICES BY THE CONTRACTOR SHALL BE DIRECTED BY THE ENGINEER.

ISSUE RECORD:		
NO.	DATE	DESCRIPTION

ITS MESSAGE BOARDS

THE EXISTING ITS MESSAGE BOARDS IN THE VICINITY OF THE PROJECT WILL BE UTILIZED WHEN AVAILABLE TO PROVIDE SUPPLEMENTAL INFORMATION TO THE TRAVELING PUBLIC. THE CONTRACTOR WILL NOTIFY THE PROJECT ENGINEER ONE [1] WEEK IN ADVANCE OF ANY PHASE CHANGE ON SUM-76/77/8-8.42/9.47/0.00. THE PROJECT ENGINEER WILL COORDINATE WITH THE PROJECT ENGINEER TO GET THE ITS MESSAGE BOARDS ADJUSTED.

ITEM 614 WORK ZONE PAVEMENT MARKINGS, AS PER PLAN

IN ADDITION TO THE REQUIREMENTS OF 614.11, ALL CLASS 1 EDGE LINES, LANE LINES, CENTER LINES AND DOTTED LINES SHALL BE 6 INCHES WIDE AND CHANNELIZING MARKINGS SHALL BE 12 INCHES WIDE. THE APPLICATION RATES FOR THE 6 INCH LINES SHALL BE 1.5 TIMES THE RATES SPECIFIED FOR 4 INCH LINES IN TABLE 614.11-1.

ITEM 614 WORK ZONE PAVEMENT MARKINGS, SPRAY THERMOPLASTIC, AS PER PLAN

THE CONTRACTOR SHALL PLACE THE WORK ZONE PAVEMENT MARKINGS, SPRAY THERMOPLASTIC, AS PER PLAN PER ODOT SPECIFICATION 614.11 AND ODOT SPECIFICATION 648 WITH THE EXCEPTION ODOT SPECIFICATION 648.05 SHALL BE MODIFIED TO ALLOW PLACEMENT OF THE MATERIAL AT A TEMPERATURE OF NOT LESS THAN 35 DEGREES FAHRENHEIT.

DELINEATION OF TEMPORARY AND PERMANENT GUARDRAIL

BARRIER REFLECTORS SHALL BE INSTALLED ON ALL TEMPORARY GUARDRAIL USED FOR TRAFFIC CONTROL AND ON ALL PERMANENT GUARDRAIL LOCATED WITHIN 5 FEET OF THE EDGE OF THE ADJACENT TRAVEL LANE. BARRIER REFLECTORS SHALL CONFORM TO C&MS 626.

OBJECT MARKERS SHALL BE INSTALLED ON ALL TEMPORARY AND PERMANENT GUARDRAIL LOCATED WITHIN 5 FEET OF THE EDGE OF THE ADJACENT TRAVEL LANE. GUARDRAIL-MOUNTING OF OBJECT MARKERS SHALL BE MADE BY INSTALLING THE OBJECT MARKERS ON THE EXTENSION BLOCKS RATHER THAN DIRECTLY ONTO THE GUARDRAIL ITSELF. OBJECT MARKERS SHALL CONFORM TO C&MS 614.03 AND THE SPACING SHALL BE APPROXIMATELY 50 FEET.

DUST CONTROL

THE CONTRACTOR SHALL FURNISH AND APPLY WATER FOR DUST CONTROL AS DIRECTED BY THE ENGINEER.

COOPERATION BETWEEN CONTRACTORS

THE CONTRACTOR SHALL BE ADVISED THAT PROJECTS SUM-77/277/US224 VARIOUS (PID 106002), SUM-8-1.75 (PID 91710), DO4 ITS MAINT FY 2021 (PID 113833), AND SUM-77-15.87 (PID 88937) MAY BE ONGOING IN AN AREA IMMEDIATELY ADJACENT TO AND WITHIN THE PROJECT LIMITS OF THIS PROJECT. THE CONTRACTOR SHALL SCHEDULE HIS WORK SO AS TO CAUSE A MINIMUM OF DELAY OR CONFLICT WITH THE OTHER PROJECTS. IN ACCORDANCE WITH 105.08, THE CONTRACTOR SHALL ARRANGE WITH THE OTHER CONTRACTORS APPROVAL OF THE ENGINEER. THE CONTRACTOR SHALL RECEIVE DAILY APPROVALS FROM THE ENGINEER PRIOR TO COMMENCING ANY OPERATIONS. ANY CONFLICT BETWEEN CONTRACTORS INVOLVING WORK SCHEDULES, WORK AREA, OR COOPERATION SHALL BE RESOLVED BY THE ENGINEER.

d:\VANVAIPWINTO\parsons.com:Ohio State\Documents\DB-Akron_Beltway_Rehab\10 - Design\02329_M01\Sheets\BU-05\02329_MNBU5002.dgn Sheet 9/28/2021 12:57:01 PM apllpchuk

BRIDGE PAINTING EQUIPMENT ON SHOULDERS

IF BRIDGE PAINTING EQUIPMENT IS TO REMAIN ON THE SHOULDERS WHEN THE CONTRACTOR IS NOT WORKING, IT SHALL BE PLACED BEHIND PORTABLE CONCRETE BARRIER (PCB) AND A WORK ZONE IMPACT ATTENUATOR (WZIA) SHALL PROTECT THE LEADING BLUNT END OF THE PCB (SEE OMTCD, FIGURE 6H-5 "SHOULDER CLOSURE ON FREEWAY" (TYPICAL APPLICATION 5)).

ADVANCED NOTICE TO PAVE

THE CONTRACTOR SHALL SUBMIT FOR APPROVAL TO THE DISTRICT CONSTRUCTION ENGINEER A DETAILED SCHEDULE 15 DAYS PRIOR TO THE PLACEMENT OF THE OVERLAY COURSES, ON HOW THEY PROPOSE TO PROSECUTE THE PAVING OPERATIONS. THE DETAILS SHALL SHOW THE ORDER OF PERFORMANCE OF EACH STAGE (START TO FINISH) OF THE WORK INCLUDING THE MAINTENANCE OF TRAFFIC THAT WILL BE USED.

ITEM 615 - PAVEMENT FOR MAINTAINING TRAFFIC, CLASS A, AS PER PLAN

IN ADDITION TO THE REQUIREMENTS OF 615

ON THIS PROJECT THE CLASS A PAVEMENT FOR MAINTAINING TRAFFIC SHALL BE 18 FEET WIDE AND THE ROADWAY WIDTH SHALL NOT BE LESS THAN 22 FEET OUT TO OUT OF SHOULDERS. THE EXISTING PAVEMENT/SHOULDER SHALL BE SAWCUT AS PER 203.04(E).

UPON COMPLETION OF THE PROJECT, THE CONTRACTOR SHALL REMOVE THE PAVEMENT FOR MAINTAINING TRAFFIC INCLUDING ANY TEMPORARY DRAINAGE FACILITIES. THE AFFECTED EXISTING EARTH MEDIAN AND PAVED SHOULDERS SHALL BE RESTORED TO THEIR ORIGINAL CONDITION AS DIRECTED BY THE ENGINEER AND AS PER 615.08.

PAVEMENT FOR MAINTAINING TRAFFIC SHALL NOT BE OPENED TO TRAFFIC UNTIL ALL WORK ZONE TRAFFIC CONTROL DEVICES, SIGNS, PAVEMENT MARKINGS AND PORTABLE CONCRETE BARRIERS HAVE BEEN ERECTED AND APPROVED BY THE ENGINEER.

ITEM 615 PAVEMENT FOR MAINTAINING TRAFFIC, CLASS B, AS PER PLAN, TYPE 1

ITEM 615 PAVEMENT FOR MAINTAINING TRAFFIC, CLASS B, AS PER PLAN, TYPE 2

ITEM 615 PAVEMENT FOR MAINTAINING TRAFFIC, CLASS B, AS PER PLAN, TYPE 3

ITEM 615 PAVEMENT FOR MAINTAINING TRAFFIC, CLASS B, AS PER PLAN, TYPE 4

THIS ITEM SHALL BE UTILIZED FOR THE PAVEMENT REPAIRS NEEDED DURING THIS CONSTRUCTION PROCESS. ALL AREAS TO BE REPAIRED SHALL BE LOCATED BY THE ENGINEER. IT IS LIKELY THAT REPAIRS WILL BE NEEDED PRIOR TO EACH PHASE SWITCH. GREAT CARE SHALL BE TAKEN TO MAINTAIN THE EXISTING PAVEMENT CROSS SLOPE AS WELL AS ALL LONGITUDINAL SLOPES. THE TYPE OF REPAIR SHALL BE DETERMINED BY THE PROJECT ENGINEER. PAYMENT FOR ALL LABOR, EQUIPMENT AND MATERIALS REQUIRED FOR MAINTENANCE OF TRAFFIC FOR PAVEMENT REPAIRS SHALL BE INCLUDED IN THE LUMP SUM CONTRACT PRICE FOR ITEM 614, MAINTAINING TRAFFIC.

TYPE 1 - IS TO BE USED WHEN YOU NEED TO MILL & FILL AN AREA OF VARYING LENGTH AND HAVE AN AVERAGE WIDTH OF NOT LESS THAN 2 FEET.

TYPE 2 - IS TO BE USED FOR FIXING THE LONGITUDINAL JOINT ISSUES OF VARYING LENGTH AND HAVE A CONSISTENT WIDTH OF 2 FEET.

TYPE 3 - IS TO BE USED FOR DEEPER REPAIRS (POTHLES) OF VARYING LENGTH AND WILL HAVE AN AVERAGE WIDTH OF NOT LESS THAN 4 FEET.

TYPE 4 - IS TO BE USED FOR COMPOSITE PAVEMENT REPAIRS OF VARYING LENGTH AND WILL HAVE AN AVERAGE WIDTH OF NOT LESS THAN 3 FEET.

WET REFLECTIVE (WR) WORK ZONE PAVEMENT MARKINGS

ALL CLASS I WORK ZONE PAVEMENT MARKINGS ON INTERSTATES AND MULTILANE HIGHWAYS EXPECTED TO BE IN PLACE LONGER THAN 14 DAYS SHOULD BE SPECIFIED AS WET REFLECTIVE BY REFERENCING EITHER WORK ZONE MARKING MATERIAL TYPE 807 (WET REFLECTIVE LIQUID APPLIED BINDER) OR 873 (WET REFLECTIVE REMOVABLE TAPE).

TO AVOID SCARRING ON THE FINAL SURFACE COURSE, WET REFLECTIVE REMOVABLE TAPE SHOULD BE SELECTED WHEN REMOVAL OF THE TEMPORARY MARKING FROM THE FINAL SURFACE COURSE IS NECESSARY PRIOR TO INSTALLATION OF THE PERMANENT MARKING.

IF THE WORK ZONE MARKING ON THE FINAL SURFACE COURSE IS IN THE LOCATION OF THE FINAL PERMANENT PAVEMENT MARKING AND THE FINAL PERMANENT PAVEMENT MARKING WILL BE A RECESSED MARKING, THE WORK ZONE MARKING DOES NOT NEED TO BE REMOVED PRIOR TO INSTALLATION OF THE PERMANENT MARKING.

ITEM 614 MAINTAINING TRAFFIC MISC.: BRIDGE DECK PATCHING AND PAVEMENT PATCHING

Released for Construction
Thomas J Powell, PE
10/04/2021

THIS WORK WILL BE AS DIRECTED BY THE ENGINEER AND WILL INCLUDE ALL ASSOCIATED MOT COSTS WITH THE ACTIVITY. THE FIXED AMOUNT SHOWN IN THE PROPOSAL IS INCLUDED (AS ANY OTHER BID ITEMS) IN THE TOTAL BID AMOUNT. THIS FIXED AMOUNT IS THE DEPARTMENT'S ESTIMATE OF THE TOTAL COST OF BRIDGE DECK AND PAVEMENT PATCHING WORK REQUIRED TO BE PERFORMED WITHIN THE WORK LIMITS AS DIRECTED BY THE ENGINEER. C&MS TABLE 104.02-2 DOES NOT APPLY TO REDUCTIONS IN THIS CONTRACT ITEM. FORCE ACCOUNT RECORDS SHALL BE KEPT TO TRACK AND ULTIMATELY DETERMINE THE AMOUNT OF THE PAY ITEM USED. THE WORK ITEM SHALL INCLUDE ALL WORK, AS DIRECTED BY THE ENGINEER, NEEDED TO RE-ESTABLISH A REASONABLY SAFE AND PASSABLE CONDITION OF THE DECK AND/OR PAVEMENT FOR THE DURATION OF THE REQUIRED UPCOMING MOT PHASES. THE CONTRACTOR SHALL MEET WITH THE ENGINEER TO ESTABLISH THE WORK AFTER EXECUTION OF THE CONTRACT. THE CONTRACTOR'S PROPOSED PHASING AND PHASING DURATIONS WILL ASSIST THE ENGINEER IN DETERMINING THE EXTENT OF THE WORK. THIS WORK IS ONLY INTENDED TO ESTABLISH A SAFE AND DRIVABLE CONDITION FOR THE DURATION OF THE PROJECT. THIS DOES NOT RELIEVE THE CONTRACTOR OF THE RESPONSIBILITIES OF 614.02B.

PORTABLE BARRIER PLACEMENT

DURING THE PLACEMENT OF THE PORTABLE BARRIER, TRAFFIC WILL BE PROHIBITED FROM OCCUPYING THE TRAVEL LANE ADJACENT TO THE BARRIER. THE BARRIER WILL BE PLACED AT NIGHT PER THE WORK HOUR RESTRICTION NOTE AND IN ACCORDANCE WITH THE PERMITTED LANE CLOSURE MAP. THE CLOSURE OF THE ADJACENT LANE WILL BE PER THE STANDARD DRAWING MT-95.30.

THE CONTRACTOR WILL SUBMIT A PLAN TO THE ENGINEER FOR APPROVAL SEVEN (7) DAYS IN ADVANCE OF THE PLANNED LANE CLOSURE. WORK WILL NOT BEGIN UNTIL APPROVAL OF THE PLANS HAS BEEN GRANTED.

SPECIAL - WORK ZONE GUARDRAIL

THIS WORK AND MATERIALS SHALL COMPLY WITH ITEM 606 FOR PERMANENT GUARDRAIL, EXCEPT THAT USED TYPE 5 RAILS AND POSTS MAY BE USED IF IN GOOD CONDITION AND APPROVED BY THE ENGINEER. FOR EXISTING GUARDRAIL RUNS WHICH REQUIRE AN EXTENSION, THE EXISTING END TERMINAL ASSEMBLY SHALL BE REMOVED AND RESET TO THE NEW LOCATIONS, AS SHOWN ON THE PLANS. NEW RUNS, FOR BRIDGE PARAPET PROTECTION SHALL HAVE THE APPROPRIATE BRIDGE TERMINAL ASSEMBLIES INSTALLED. UPON COMPLETION OF THE PHASE WHICH REQUIRES THE TEMPORARY GUARDRAIL, ALL WORK ZONE GUARDRAIL SHALL BE REMOVED AND THE POST HOLES BACKFILLED (UNLESS PERMANENT GRADING TO BE PERFORMED LATER WOULD REPAIR THE HOLES), ALL TERMINAL ASSEMBLIES REMOVED, AND END TERMINAL ASSEMBLIES RESET TO THEIR ORIGINAL LOCATION.

DRUM REQUIREMENTS

IN ADDITION TO THE REQUIREMENTS OF THE PLANS, SPECIFICATION AND PROPOSAL, DRUMS FURNISHED BY THE CONTRACTOR SHALL BE NEW AND UNUSED AT THE TIME OF ARRIVAL ON THE PROJECT. ANY DRUMS BROUGHT ON THE PROJECT, WHICH HAVE PREVIOUSLY BEEN USED ELSEWHERE, WILL NOT BE ACCEPTED.

ISSUE RECORD:		
NO.	DATE	DESCRIPTION

ITEM 622, PORTABLE BARRIER, 50", AS PER PLAN

THIS WORK SHALL CONSIST OF FURNISHING, MAINTAINING, AND SUBSEQUENTLY REMOVING A 50-INCH PORTABLE BARRIER AT THE LOCATIONS SHOWN ON THE PLANS. FOR DETAILS, SEE SCD RM-4.1.

PORTABLE STEEL BARRIER IS AN APPROVED ALTERNATIVE TO PORTABLE CONCRETE BARRIER. FOR INFORMATION ON APPROVED VENDORS, SEE THE APPROVED PRODUCTS LIST MAINTAINED BY ROADWAY ENGINEERING.

PORTABLE BARRIER, 32 INCHES HIGH WITH AN 18-INCH MINIMUM HEIGHT GLARE SCREEN MAY BE USED AT THE OPTION OF THE CONTRACTOR. THE GLARE SCREEN SHALL BE CONSTRUCTED USING ONE OF THE SCREENS PROVIDED ON THE APPROVED LIST, AVAILABLE ON THE OFFICE OF ROADWAY ENGINEERING WEBSITE.

PADDLE OR INTERMITTENT TYPE GLARE SCREENS SHALL BE DESIGNED USING A 20 DEGREE CUT-OFF ANGLE BASED ON TANGENT ALIGNMENT. THAT SPACING SHALL BE USED THROUGHOUT THE BARRIER LENGTH WITHOUT REGARD TO BARRIER CURVATURE.

THE GLARE SCREEN SYSTEM SHALL BE SECURELY FASTENED TO THE 32-INCH PORTABLE BARRIER USING THE HARDWARE AND PROCEDURES SPECIFIED BY THE MANUFACTURER.

FOR DIRECTIONS ON HOW TO INSTALL THE GLARE SCREEN AND THE BARRIER, SEE THE MANUFACTURER'S INSTRUCTIONS.

DELINEATION OF PORTABLE AND PERMANENT BARRIER

BARRIER REFLECTORS AND OBJECT MARKERS SHALL BE INSTALLED ON ALL PORTABLE BARRIER (PB) USED FOR TRAFFIC CONTROL AND ON PERMANENT CONCRETE BARRIER (INCLUDING BRIDGE PARAPETS) LOCATED WITHIN 5 FEET OF THE EDGE OF THE ADJACENT TRAVEL LANE.

BARRIER REFLECTORS SHALL CONFORM TO C&MS 626, EXCEPT THAT THE SPACING SHALL BE AS PER TRAFFIC SCD MT-101.70. OBJECT MARKERS AND THEIR INSTALLATION SHALL CONFORM TO C&MS 614.03 AND SCD MT-101.70. WHEN THE PB CONTAINS GLARE SCREEN, ONE SET OF THREE VERTICAL STRIPES OF SHEETING SHALL BE CONSIDERED EQUIVALENT TO AN OBJECT MARKER, ONE-WAY.

INCREASED BARRIER DELINEATION, AS SPECIFIED HEREIN, SHALL BE INSTALLED ON ALL PB AND CONCRETE PERMANENT BARRIER LOCATED WITHIN 5 FEET OF THE EDGE OF THE TRAVELED LANE UNDER EITHER OF THE FOLLOWING CONDITIONS: ALONG TAPERS AND TRANSITION AREAS AND ALONG CURVES (OUTSIDE ONLY) WITH DEGREE OF CURVATURE GREATER THAN OR EQUAL TO 3 DEGREES.

THE INCREASED BARRIER DELINEATION SHALL CONSIST OF EITHER DELINEATION PANELS OR THE TRIPLE STACKING OF WORK ZONE BARRIER REFLECTORS.

DELINEATION PANELS SHALL CONSIST OF PANELS OF DELINEATION, APPROXIMATELY 34 INCHES LONG AND 6 INCHES WIDE AND SHALL BE "CRIMPED." PANELS SHALL BE INSTALLED AND SPACED PER TRAFFIC SCD MT-101.70.

TRIPLE-STACKED BARRIER REFLECTORS SHALL CONSIST OF ALIGNING THREE BARRIER REFLECTORS VERTICALLY, AT LOCATIONS WHERE A SINGLE BARRIER REFLECTOR WOULD BE OTHERWISE ATTACHED. THERE SHALL BE NO OPEN SPACE BETWEEN THE ADJACENT BARRIER REFLECTORS. THE TRIPLE-STACKED BARRIER REFLECTORS SHALL CONFORM TO C&MS 626, EXCEPT THAT THEY SHALL BE SPACED AND ALIGNED PER TRAFFIC SCD MT-101.70.

MAINTENANCE OF TRAFFIC NOTES

2021-09-29 - BU 05 - RELEASED FOR CONSTRUCTION PLANS

SUM-76 / 77 / 8-
8.24 / 9.74 / 0.00

d:\VANVAIPWINTO\par sons.com:Ohio State Documents\Beltway Rehab\10 - Design\02329\M01\Sheets\BU-05\02329.MNBU5003.dgn Sheet 9/28/2021 12:57:04 PM aplipchuk

ITEM 614, WORK ZONE IMPACT ATTENUATOR FOR 24" WIDE HAZARDS (UNIDIRECTIONAL OR BIDIRECTIONAL)

THIS ITEM SHALL CONSIST OF FURNISHING AND INSTALLING A NON-GATING IMPACT ATTENUATOR. FURNISH AN IMPACT ATTENUATOR FROM THE OFFICE OF ROADWAY ENGINEERING'S APPROVED LIST FOR WORK ZONE IMPACT ATTENUATORS, FROM THE ROADWAY STANDARDS APPROVED PRODUCTS WEB PAGE.

INSTALLATION SHALL BE AT THE LOCATIONS SPECIFIED IN THE PLANS IN ACCORDANCE WITH THE MANUFACTURER'S SPECIFICATIONS.

THE CONTRACTOR SHALL REPAIR OR REPLACE A DAMAGED UNIT WITHIN 24 HOURS OF A DAMAGING IMPACT.

WHEN BIDIRECTIONAL DESIGNS ARE SPECIFIED, THE CONTRACTOR SHALL SUPPLY APPROPRIATE TRANSITIONS.

WHEN GATING IMPACT ATTENUATORS ARE DESIRED, THE CONTRACTOR SHALL SUBMIT DOCUMENTATION TO THE ENGINEER FOR ACCEPTANCE.

ITEM 614, WORK ZONE IMPACT ATTENUATOR FOR HAZARDS OVER 24" AND LESS THAN 36" WIDE (UNIDIRECTIONAL OR BIDIRECTIONAL)

THIS ITEM SHALL CONSIST OF FURNISHING AND INSTALLING A NON-GATING IMPACT ATTENUATOR. FURNISH AN IMPACT ATTENUATOR FROM THE OFFICE OF ROADWAY ENGINEERING'S APPROVED LIST FOR WORK ZONE IMPACT ATTENUATORS, FROM THE ROADWAY STANDARDS APPROVED PRODUCTS WEB PAGE.

INSTALLATION SHALL BE AT THE LOCATIONS SPECIFIED IN THE PLANS, IN ACCORDANCE WITH THE MANUFACTURER'S SPECIFICATIONS. THE CONTRACTOR SHALL REPAIR OR REPLACE A DAMAGED UNIT WITHIN 24 HOURS OF A DAMAGING IMPACT.

WHEN BIDIRECTIONAL DESIGNS ARE SPECIFIED, THE CONTRACTOR SHALL SUPPLY APPROPRIATE TRANSITIONS.

FLOODLIGHTING

FLOODLIGHTING OF THE WORK SITE FOR OPERATIONS CONDUCTED DURING NIGHTTIME PERIODS SHALL BE ACCOMPLISHED SO THAT THE LIGHTS DO NOT CAUSE GLARE TO THE DRIVERS ON THE ROADWAY. TO ENSURE THE ADEQUACY OF THE FLOODLIGHT PLACEMENT, THE CONTRACTOR AND THE ENGINEER SHALL DRIVE THROUGH THE WORK SITE EACH NIGHT WHEN THE LIGHTING IS IN PLACE AND OPERATIVE PRIOR TO COMMENCING ANY WORK. IF GLARE IS DETECTED, THE LIGHT PLACEMENT AND SHIELDING SHALL BE ADJUSTED TO THE SATISFACTION OF THE ENGINEER BEFORE WORK PROCEEDS.

ITEM 611 - 12", SLOTTED DRAIN, TYPE 2

THIS ITEM SHALL CONSIST OF 12 INCH DIAMETER SLOTTED DRAIN ALUMINUM COATED STEEL CONDUIT 707.01 WITH 6 INCH TRAPEZOIDAL GALVANIZED SOLID BAR GRATE AS APPROVED BY THE ENGINEER.

ITEM 614 - WORK ZONE RAISED PAVEMENT MARKER, AS PER PLAN

WORK ZONE RAISED PAVEMENT MARKERS, AS PER PLAN, AND THEIR INSTALLATION SHALL CONFORM TO C&MS 614 OR C&MS 621 AS SPECIFIED HEREIN.

RAISED PAVEMENT MARKERS IN USE DURING THE SNOW-PLOWING SEASON SHALL CONFORM TO 621, EXCEPT FOR RAISED PAVEMENT MARKERS ON PERMANENT CONCRETE SURFACES. SEE ITEM 614 - WORK ZONE RAISED PAVEMENT MARKERS ON PERMANENT CONCRETE SURFACES NOTE BELOW.

RAISED PAVEMENT MARKERS IN USE DURING THE NON-SNOW-PLOW SEASON SHALL CONFORM TO EITHER 614 OR TO 621.

THE SNOW-PLOWING SEASON SHALL RUN FROM OCTOBER 15 THROUGH APRIL 1.

IF PROJECT DELAYS, NOT THE FAULT OF ODOT, CAUSE THE WORK TO EXTEND INTO THE SNOW-PLOWING SEASON, THE CONTRACTOR SHALL BE RESPONSIBLE FOR REPLACING WORK ZONE RAISED PAVEMENT MARKERS (WZRPMS) CONFORMING TO C&MS 614, WITH RAISED PAVEMENT MARKERS CONFORMING TO 621, AS DETERMINED BY THE ENGINEER, AT THE CONTRACTOR'S EXPENSE.

THIS ITEM SHALL INCLUDE PURCHASE, INSTALLATION AND REMOVAL OF ITEM 614 WORK ZONE RAISED PAVEMENT MARKER, AS PER PLAN, INCLUDING FILLING OF ANY DEPRESSIONS CREATED IN THE PAVEMENT AS PER C&MS 621.08.

RESURFACING OF THE TRANSITION AREAS SHALL BE PERFORMED AT THE TIME THAT THE SURFACE COURSE IS BEING APPLIED TO THE ENTIRE PROJECT. PRIOR TO APPLICATION OF THE SURFACE COURSE ON THE PROJECT, THE EXISTING PAVEMENT WITHIN THE TRANSITION AREA SHALL BE REMOVED TO A DEPTH NECESSARY TO REACH THE LEVEL OF THE INTERMEDIATE COURSE OF THE PAVEMENT, AS DETERMINED BY THE ENGINEER.

ITEM 614 - WORK ZONE RAISED PAVEMENT MARKERS ON PERMANENT CONCRETE SURFACES

RAISED PAVEMENT MARKERS IN WORK ZONES, INSTALLED ON PERMANENT CONCRETE SURFACES, SHALL BE ITEM 614 WORK ZONE RAISED PAVEMENT MARKERS. WZRPMS ARE INTENDED FOR USE ONLY DURING THE NON-SNOW-PLOWING SEASON. WZRPMS SHALL NOT BE PROVIDED DURING THE SNOW-PLOWING SEASON.

THE SNOW-PLOWING SEASON SHALL RUN FROM OCTOBER 15 THROUGH APRIL 1.

WHERE A TEMPORARY ALIGNMENT WILL REMAIN IN USE THROUGH THE WINTER, THE WZRPMS SHALL BE REMOVED PRIOR TO THE BEGINNING OF THE SNOW-PLOWING SEASON AND REPLACED APPROXIMATELY APRIL 1, OR AS OTHERWISE DETERMINED BY THE ENGINEER.

ITEM 614 - LAW ENFORCEMENT OFFICER (WITH PATROL CAR) FOR ASSISTANCE DURING CONSTRUCTION OPERATIONS

Released for Construction
Thomas J Powell, PE
10/04/2021

USE OF LAW ENFORCEMENT OFFICERS (LEOS) BY CONTRACTORS OTHER THAN THE USES SPECIFIED BELOW WILL NOT BE PERMITTED AT PROJECT COST. LEOS SHOULD NOT BE USED WHERE THE OMUTCD INTENDS THAT FLAGGERS BE USED.

IN ADDITION TO THE REQUIREMENTS OF C&MS 614 AND THE OMUTCD, A UNIFORMED LEO WITH AN OFFICIAL PATROL CAR (CAR WITH TOP-MOUNTED EMERGENCY FLASHING LIGHTS AND COMPLETE MARKINGS OF THE APPROPRIATE LAW ENFORCEMENT AGENCY) SHALL BE PROVIDED FOR THE FOLLOWING TRAFFIC CONTROL TASKS:

DURING THE ENTIRE ADVANCE PREPARATION AND CLOSURE SEQUENCE WHERE COMPLETE BLOCKAGE OF TRAFFIC IS REQUIRED.

DURING A TRAFFIC SIGNAL INSTALLATION WHEN IMPACTING THE NORMAL FUNCTION OF THE SIGNAL OR THE FLOW OF TRAFFIC, OR WHEN TRAFFIC NEEDS TO BE DIRECTED THROUGH AN ENERGIZED TRAFFIC SIGNAL CONTRARY TO THE SIGNAL DISPLAY (E.G., DIRECTING MOTORISTS THROUGH A RED LIGHT).

IN ADDITION TO THE REQUIREMENT OF C&MS 614 AND THE OMUTCD, A UNIFORMED LEO WITH AN OFFICIAL PATROL CAR (CAR WITH TOP-MOUNTED EMERGENCY FLASHING LIGHTS AND COMPLETE MARKINGS OF THE APPROPRIATE LAW ENFORCEMENT AGENCY) SHOULD BE PROVIDED FOR THE FOLLOWING TRAFFIC CONTROL TASKS AS APPROVED BY THE ENGINEER:

FOR LANE CLOSURES: DURING INITIAL SET-UP PERIODS, TEAR DOWN PERIODS, SUBSTANTIAL SHIFTS OF A CLOSURE POINT OR WHEN NEW LANE CLOSURE ARRANGEMENTS ARE INITIATED FOR LONG-TERM LANE CLOSURES/SHIFTS (FOR THE FIRST AND LAST DAY OF MAJOR CHANGES IN TRAFFIC CONTROL SETUP).

FOR OPERATIONS WITHOUT POSITIVE PROTECTION OCCURRING WITHIN 10 FEET OF AN OPEN TRAVELED LANE THAT MEET ALL OF THE FOLLOWING CRITERIA:
-ON A MULTI-LANE DIVIDED INTERSTATE, OTHER FREEWAY OR EXPRESSWAY; AND
-AN AUTHORIZED SPEED LIMIT OF 45 MPH OR GREATER THAT IS IN EFFECT AT THE TIME OF THE OPERATION; AND,
-AADT OF 50,000 (OR AADT OF 30,000 WITH 25% OR HIGHER PERCENT TRUCKS)

"WITHOUT POSITIVE PROTECTION" MEANS USE OF DRUMS, CONES, SHADOW VEHICLE, ETC, WITHOUT PROTECTION FROM PORTABLE BARRIER OR OTHER RIGID BARRIER ALONG THE WORK AREA. THIS PHRASE DOES NOT APPLY TO CASES WHERE POSITIVE PROTECTION IS REQUIRED. MOBILE OPERATIONS ARE REGARDED AS "WITHOUT POSITIVE PROTECTION". FOR WORK ZONES USING A COMBINATION OF BARRIER AND TEMPORARY TRAFFIC CONTROL DEVICES (CONES, DRUMS, ETC), THE DESIGNATION SHALL BE BASED UPON THE TYPE OF DEVICES USED IN THE AREA THAT WORKERS ARE LOCATED.

IF MULTIPLE ACTIVE LOCALIZED QUALIFYING WORK AREAS OCCUR WITHOUT POSITIVE PROTECTION, PER MAINLINE TRAFFIC DIRECTION, PROVIDE A UNIFORMED LEO AND OFFICIAL PATROL CAR IN ADVANCE OF:
-THE FIRST ACTIVE WORK AREA THAT DRIVERS WILL ENCOUNTER; OR
-THE ACTIVE WORK AREA Laterally CLOSEST TO THE OPEN TRAVELED LANE; OR

ISSUE RECORD:		
NO.	DATE	DESCRIPTION

ITEM 614 - LAW ENFORCEMENT OFFICER (WITH PATROL CAR) FOR ASSISTANCE DURING CONSTRUCTION OPERATIONS (CONT'D)

-OTHER LOCATION AS APPROVED BY THE ENGINEER. THE UNIFORMED LEO AND OFFICIAL PATROL CAR MAY RELOCATE AMONG THE LISTED LOCATIONS AS APPROPRIATE AS THE OPERATIONS PROCEED IN THE LOCALIZED QUALIFYING WORK AREAS.

IN GENERAL, LEOS SHOULD BE POSITIONED IN ADVANCE OF AND ON THE SAME SIDE AS THE LANE RESTRICTION (OR AT THE POINT OF ROAD CLOSURE), AND TO MANUALLY CONTROL TRAFFIC MOVEMENTS THROUGH SIGNALIZED INTERSECTIONS IN WORK ZONES.

LEOS SHOULD NOT FORGO THEIR TRAFFIC CONTROL RESPONSIBILITIES TO APPREHEND MOTORISTS FOR ROUTINE TRAFFIC VIOLATIONS. HOWEVER, IF A MOTORIST'S ACTIONS ARE CONSIDERED TO BE RECKLESS, THEN PURSUIT OF THE MOTORIST IS APPROPRIATE.

THE LEOS WORK AT THE DIRECTION OF THE CONTRACTOR. THE CONTRACTOR IS RESPONSIBLE FOR SECURING THE SERVICES OF THE LEOS WITH THE APPROPRIATE AGENCIES AND COMMUNICATING THE INTENTIONS OF THE PLANS WITH RESPECT TO DUTIES OF THE LEOS. THE ENGINEER SHALL HAVE FINAL CONTROL OVER THE LEOS' DUTIES AND PLACEMENT, AND WILL RESOLVE ANY ISSUES THAT MAY ARISE BETWEEN THE TWO PARTIES.

ENSURE PROVIDED LEOS HAVE BEEN TRAINED APPROPRIATE TO THE JOB DECISIONS THEY ARE REQUIRED TO MAKE WHILE ON THE PROJECT, IN ACCORDANCE WITH C&MS 614.03.

THE LEO SHALL REPORT IN TO THE CONTRACTOR PRIOR TO THE START OF THE SHIFT, IN ORDER TO RECEIVE INSTRUCTIONS REGARDING SPECIFIC WORK ASSIGNMENTS DURING HIS/HER SHIFT. THE LEO IS EXPECTED TO STAY AT THE PROJECT SITE FOR THE ENTIRE DURATION OF HIS/HER SHIFT. THE LEO SHALL REPORT TO THE CONTRACTOR AT THE END OF HIS/HER SHIFT. SHOULD IT BE NECESSARY TO LEAVE THE PROJECT SITE, THE LEO SHALL NOTIFY THE ENGINEER. THE CONTRACTOR SHALL PROVIDE THE LEO WITH A TWO-WAY COMMUNICATION DEVICE THAT SHALL BE RETURNED TO THE CONTRACTOR AT THE END OF HIS/HER SHIFT.

CONCRETE MEDIAN BARRIER REPLACEMENT

REMOVING, GRADING AND INSTALLING THE REPLACEMENT BARRIER IN A CONTINUOUS OPERATION SHALL BE LIMITED TO 250 LINEAR FEET AND SHALL AT ALL TIMES BE SUBJECT TO THE APPROVAL OF THE ENGINEER. THE ENGINEER SHALL BE SATISFIED THAT ALL INSTALLATIONS WILL AFFORD MAXIMUM PROTECTION FOR TRAFFIC.

EARTHWORK FOR MAINTAINING TRAFFIC

WHEN UNDERCUTS ARE NECESSARY FOR MAINLINE PAVEMENT OR EMBANKMENT CONSTRUCTION, EVALUATE THE NEED FOR TEMPORARY ROAD UNDERCUTS IF WITHIN A CLOSE PROXIMITY TO THE MAINLINE UNDERCUTS. A GEOTECHNICAL EVALUATION SHOULD BE CONSIDERED TO DETERMINE IF THE EXISTING SOIL CONDITIONS ARE ADEQUATE TO SUPPORT THE TEMPORARY ROAD. ADDITIONAL SOIL BORINGS ALONG THE TEMPORARY ROAD ARE NOT NORMALLY REQUIRED.

2021-09-29 - BU 05 - RELEASED FOR CONSTRUCTION PLANS

MAINTENANCE OF TRAFFIC NOTES

SUM-76 / 77 / 8 -
8.24 / 9.74 / 0.00

CALCULATED
FGW
CHECKED
AVP

d:\VANVAIPWINTO\parsons.com\Ohio State\Documents\DB-Akron_Beltway_Rehab\10 - Design\02329_M0T\Sheets\BU-05\02329_MNBU5004.dgn Sheet 9/28/2021 12:57:09 PM aplipchuk

SPECIAL, MAINTAIN EXISTING LIGHTING

EXISTING ROADWAYS WHICH ARE TO REMAIN OPEN TO TRAFFIC DURING CONSTRUCTION OF THIS PROJECT AND WHICH ARE LIGHTED SHALL HAVE THE LIGHTING MAINTAINED AS DESCRIBED HEREIN.

BEFORE ANY WORK IS STARTED IN THE IMMEDIATE VICINITY OF THE EXISTING LIGHTING CIRCUITS, REPRESENTATIVES OF ODOT, THE MAINTAINING AGENCY AND THE CONTRACTOR SHALL MAKE A VISUAL INSPECTION OF THE EXISTING ROADWAY LIGHTING CIRCUITS TO BE MAINTAINED. DURING THIS INSPECTION, A WRITTEN RECORD OF THE CONDITION OF EXISTING LIGHTING SHALL BE MADE BY ODOT'S REPRESENTATIVE. THIS WRITTEN REPORT SHALL NOTE INDIVIDUAL LUMINAIRES WHICH ARE NOT IN WORKING ORDER, INDIVIDUAL POLES WHICH ARE NOT STANDING, AND INDIVIDUAL CIRCUITS WHICH ARE NOT IN WORKING ORDER. THE COMPLETED REPORT SHALL BE SIGNED BY THE REPRESENTATIVES OF ODOT, THE MAINTAINING AGENCY AND THE CONTRACTOR.

IF, AS A RESULT OF THIS INSPECTION, IT IS DETERMINED THAT THE CONDITION OF THE EXISTING SYSTEM IS BELOW THAT REQUIRED FOR THE SAFETY OF THE TRAVELING PUBLIC, THEN THE MAINTAINING AGENCY SHALL MAKE THE REPAIRS NECESSARY TO RETURN THE SYSTEM TO AN ACCEPTABLE CONDITION. FOLLOWING THESE REPAIRS, THE SYSTEM SHALL AGAIN BE INSPECTED AND A REPORT SHALL BE MADE AND SIGNED AS OUTLINED HEREIN.

WHEN THE EXISTING SYSTEM IS IN AN ACCEPTABLE CONDITION, IT SHALL BE TURNED OVER TO THE CONTRACTOR WHO SHALL THEN BE REQUIRED TO MAINTAIN THE EXISTING LIGHTING TO THE CONDITION OUTLINED IN THIS REPORT WITH THE EXCEPTION OF KNOCKDOWNS DUE TO TRAFFIC ACCIDENTS.

REPLACEMENT OF KNOCKED DOWN UNITS SHALL BE DONE ONLY WHEN THE ENGINEER HAS DETERMINED THAT THE REPLACEMENT OF THE KNOCKED DOWN UNIT IS NECESSARY AND SHALL BE PAID SEPARATELY ON A UNIT BASIS.

BETTERMENTS SHALL BE COVERED IN ITEMS OF WORK PERTAINING TO THE CONSTRUCTION OF PERMANENT IMPROVEMENT.

WHEN THE SEQUENCE OF CONSTRUCTION ACTIVITIES REQUIRES, OR SHOULD THE CONTRACTOR DESIRE, THE REMOVAL OF THE EXISTING LIGHTING BEFORE THE NEW LIGHTING IS OPERATIONAL, THE CONTRACTOR SHALL BE RESPONSIBLE FOR PROVIDING TEMPORARY LIGHTING OF THIS PORTION OF THE ROADWAY.

PRIOR TO INSTALLING SUCH LIGHTING, THE CONTRACTOR SHALL PREPARE AND SUBMIT FOUR SETS OF THE TEMPORARY LIGHTING PLAN TO THE ENGINEER FOR REVIEW AND APPROVAL.

THIS PLAN SHALL SHOW LOCATIONS OF POLES, LENGTHS OF BRACKET ARMS, STYLES OF LUMINAIRES, MOUNTING HEIGHTS, WIRING METHODS AND OTHER PERTINENT INFORMATION. THE TEMPORARY LIGHTING SHALL PROVIDE AN AVERAGE INITIAL INTENSITY OF 1.2 FOOTCANDLES WITH AN AVERAGE TO MINIMUM UNIFORMITY NOT TO EXCEED 3:1. MOUNTING HEIGHT OF TEMPORARY LUMINAIRES SHALL NOT BE LESS THAN 30 FEET, AND THE MINIMUM OVERHEAD CONDUCTOR CLEARANCE SHALL BE 20 FEET. TEMPORARY OVERHEAD CONSTRUCTION SHALL NOT BE LESS THAN GRADE "B" FOR STRENGTH REQUIREMENTS AS DEFINED BY THE NATIONAL ELECTRIC SAFETY CODE. WOOD POLES WITH OVERHEAD WIRING MAY BE USED. HOWEVER, TEMPORARY LIGHTING SHALL MEET FEDERAL AND STATE SAFETY CRITERIA. IF BREAKAWAY POLES ARE USED TO MEET THESE CRITERIA, THEN UNDERGROUND WIRING SHALL

SPECIAL, MAINTAIN EXISTING LIGHTING (CONT'D)

BE USED. RECONDITIONED OR USED MATERIALS MAY BE FURNISHED FOR TEMPORARY LIGHTING.

ALL MATERIALS NECESSARY TO COMPLETE THE TEMPORARY LIGHTING SHALL BE FURNISHED AND INSTALLED BY THE CONTRACTOR. WHEN NO LONGER NEEDED, THE TEMPORARY LIGHTING INSTALLATION SHALL BE REMOVED AND PROPERLY DISPOSED OF BY THE CONTRACTOR.

THE MAINTAINING AGENCY WILL PAY FOR ELECTRICAL ENERGY CONSUMED BY EXISTING POWER SERVICES AND BY PROPOSED PERMANENT POWER SERVICES AFTER ACCEPTANCE OF THE LIGHTING WORK. THE CONTRACTOR WILL PAY FOR ELECTRICAL ENERGY, INSTALLATION, REMOVAL AND MAINTENANCE OF ANY TEMPORARY POWER SERVICES.

ITEM 614, PORTABLE CHANGEABLE MESSAGE SIGNS, AS PER PLAN

THE CONTRACTOR SHALL FURNISH, INSTALL, MAINTAIN AND REMOVE, WHEN NO LONGER NEEDED, A CHANGEABLE MESSAGE SIGN. THE SIGN SHALL BE OF A TYPE SHOWN ON A LIST OF APPROVED PCMS UNITS AVAILABLE ON THE OFFICE OF MATERIALS MANAGEMENT WEB PAGE. THE LIST CONTAINS CLASS A AND B UNITS WITH MINIMUM LEGIBILITY DISTANCES OF 800 FEET AND 650 FEET, RESPECTIVELY.

EACH SIGN SHALL BE TRAILER-MOUNTED AND EQUIPPED WITH A FUNCTIONAL DIMMING MECHANISM, TO DIM THE SIGN DURING DARKNESS, AND A TAMPER AND VANDAL PROOF ENCLOSURE. EACH SIGN SHALL BE PROVIDED WITH APPROPRIATE TRAINING AND OPERATION INSTRUCTIONS TO ENABLE ON-SITE PERSONNEL TO OPERATE AND TROUBLESHOOT THE UNIT. THE SIGN SHALL ALSO BE CAPABLE OF BEING POWERED BY AN ELECTRICAL SERVICE DROP FROM A LOCAL UTILITY COMPANY. THE PCMS SHALL BE DELINEATED IN ACCORDANCE WITH C&MS 614.03.

THE PROBABLE PCMS LOCATIONS AND WORK LIMITS FOR THOSE LOCATIONS ARE SHOWN IN THE PLAN. PLACEMENT, OPERATION, MAINTENANCE AND ALL ACTIVATION OF THE SIGNS BY THE CONTRACTOR SHALL BE AS DIRECTED BY THE ENGINEER. THE PCMS SHALL BE LOCATED IN A HIGHLY VISIBLE POSITION YET PROTECTED FROM TRAFFIC. THE CONTRACTOR SHALL, AT THE DIRECTION OF THE ENGINEER, RELOCATE THE PCMS TO IMPROVE VISIBILITY OR ACCOMMODATE CHANGED CONDITIONS. WHEN NOT IN USE, THE PCMS SHALL BE TURNED OFF. ADDITIONALLY, WHEN NOT IN USE FOR EXTENDED PERIODS OF TIME, THE PCMS SHALL BE TURNED AWAY FROM ALL TRAFFIC.

THE ENGINEER SHALL BE PROVIDED ACCESS TO EACH SIGN UNIT AND SHALL BE PROVIDED WITH APPROPRIATE TRAINING AND OPERATION INSTRUCTIONS TO ENABLE ODOT PERSONNEL TO OPERATE AND TROUBLESHOOT THE UNIT, AND TO REVISE SIGN MESSAGES, IF NECESSARY.

ALL MESSAGES TO BE DISPLAYED ON THE SIGN WILL BE PROVIDED BY THE ENGINEER. A LIST OF ALL REQUIRED PRE-PROGRAMMED MESSAGES WILL BE GIVEN TO THE CONTRACTOR AT THE PROJECT PRECONSTRUCTION CONFERENCE. THE SIGN SHALL HAVE THE CAPABILITY TO STORE UP TO 99 MESSAGES. MESSAGE MEMORY OR PRE-PROGRAMMED DISPLAYS SHALL NOT BE LOST AS A RESULT OF POWER FAILURES TO THE ON-BOARD COMPUTER. THE SIGN LEGEND SHALL BE CAPABLE OF BEING CHANGED IN THE FIELD. THREE-LINE PRESENTATION FORMATS WITH UP TO SIX MESSAGE PHASES SHALL BE SUPPORTED. PCMS FORMAT SHALL PERMIT THE COMPLETE MESSAGE FOR EACH PHASE TO BE READ AT LEAST TWICE.

ITEM 614, PORTABLE CHANGEABLE MESSAGE SIGNS, AS PER PLAN (CONT'D)

Released for Construction
As per Plan
10/04/2021

THE PCMS SHALL CONTAIN AN ACCURATE CLOCK AND PROGRAMMING LOGIC WHICH WILL ALLOW THE SIGN TO BE ACTIVATED, DEACTIVATED OR MESSAGES CHANGED AUTOMATICALLY AT DIFFERENT TIMES OF THE DAY FOR DIFFERENT DAYS OF THE WEEK.

THE PCMS SHALL CONTAIN A CELLULAR TELEPHONE DATA LINK WHICH WILL (IN ACTIVE CELLULAR PHONE AREAS) ALLOW REMOTE SIGN ACTIVATION, MESSAGE CHANGES, MESSAGE ADDITIONS AND REVISIONS TO TIME OF DAY PROGRAMS. THE SYSTEM SHALL ALSO PERMIT VERIFICATION OF CURRENT AND PROGRAMMED MESSAGES. ONE REMOTE DATA INPUT DEVICE (LAPTOP COMPUTER PLUS MODEM OR EQUIVALENT) SHALL BE FURNISHED FOR USE BY THE DISTRICT TRAFFIC ENGINEER, OR EQUIVALENT, AND SHALL BE INSURED AGAINST THEFT.) THE PCMS UNIT SHALL BE MAINTAINED IN GOOD WORKING ORDER BY THE CONTRACTOR IN ACCORDANCE WITH THE PROVISIONS OF C&MS 614.07. THE CONTRACTOR SHALL, PRIOR TO ACTIVATING THE UNIT, MAKE ARRANGEMENTS, WITH AN AUTHORIZED SERVICE AGENT FOR THE PCMS, TO ASSURE PROMPT SERVICE IN THE EVENT OF FAILURE. ANY FAILURE SHALL NOT RESULT IN THE SIGN BEING OUT OF SERVICE FOR MORE THAN 12 HOURS, INCLUDING WEEKENDS. FAILURE TO COMPLY MAY RESULT IN AN ORDER TO STOP WORK AND OPEN ALL TRAFFIC LANES AND/OR IN THE DEPARTMENT TAKING APPROPRIATE ACTION TO SAFELY CONTROL TRAFFIC. THE ENTIRE COST TO CONTROL TRAFFIC, ACCRUED BY THE DEPARTMENT DUE TO THE CONTRACTOR'S NONCOMPLIANCE, WILL BE DEDUCTED FROM MONEYS DUE, OR TO BECOME DUE THE CONTRACTOR ON HIS CONTRACT.

THE CONTRACTOR SHALL BE RESPONSIBLE FOR 24-HOUR-PER-DAY OPERATION AND MAINTENANCE OF THESE SIGNS ON THE PROJECT FOR THE DURATION OF THE PHASES WHEN THE PLAN REQUIRES THEIR USE.

EXTRA ADVANCE WARNING SIGNS

AN EXTRA ADVANCE WARNING SIGN GROUP CONSISTS OF TWO W20-1 (ROAD WORK AHEAD) SIGNS, TWO W20-5 (RIGHT/LEFT LANE CLOSED AHEAD) SIGNS WITH W16-3A DISTANCE PLATES, AND TWO W3-H7 (WATCH FOR STOPPED TRAFFIC) SIGNS AND REQUIRED WARNING LIGHTS.

THE CONTRACTOR SHALL PROVIDE, ERECT, MAINTAIN AND REMOVE EXTRA ADVANCE WARNING SIGN GROUPS AS SHOWN ON TRAFFIC SCD MT-95.50 AT THE LOCATIONS SHOWN IN THE PLANS IN ADVANCE OF THE LANE TAPERS WITH THE APPROPRIATE W16-3A DISTANCE PLATES.

ISSUE RECORD:		
NO.	DATE	DESCRIPTION

ADVANCE WORK ZONE INFORMATION

ADVANCE WORK ZONE INFORMATION SIGNS, AS USED IN THIS NOTE, ARE FIXED MESSAGE TYPES. THE SIGNS ARE TO BE LOCATED AT EXTREME DISTANCE FROM THE WORK AREA, AS SHOWN IN THE PLANS.

THE SIGNS SHALL BE BLACK ON ORANGE (INCLUDING A BLACK BORDER). THE LAYOUT SHALL BE IN CONFORMANCE WITH TEM CHAPTER 211.

WHEN REGULATORY INFORMATION IS PROVIDED, IT SHALL BE DISPLAYED SEPARATELY AS A STANDARD BLACK-ON-WHITE SIGN. MIXING OF BLACK-ON-WHITE REGULATORY INFORMATION ON A BLACK-ON-ORANGE INFORMATION SIGN IS PROHIBITED.

IF THE MOTORIST IS BEING DETOURED OR IF AN ALTERNATE ROUTE IS PROVIDED, THE ROUTE SHOULD BE SIGNED WITH ASSEMBLIES CONSISTING OF THE APPROPRIATE BLACK-ON-ORANGE DETOUR OR ALT MARKER WITH A STANDARD ROUTE MARKER AND ARROW PLATE. IF MORE TARGET VALUE IS DESIRED, THIS TRAIL BLAZER INFORMATION MAY BE SHOWN ON AN ORANGE PANEL (OMUTCD SECTION 2D.32).

ROUTE SIGN ASSEMBLIES SHALL BE SIZED ACCORDING TO THE TYPE OF ROAD ON WHICH THEY ARE LOCATED IN ACCORDANCE WITH THE OMUTCD.

SUPPORTS FOR SIGN INSTALLATIONS SHALL CONFORM TO ALL EXISTING STANDARDS FOR PERMANENT SIGNS. THESE SIGNS SHOULD NOT BE ATTACHED TO EXISTING SUPPORTS.

WHERE THE PLANS CALL FOR AN OVERLAY TO COVER A PORTION OF AN EXISTING SIGN, THE OVERLAY SHALL BE BLACK-ON-ORANGE. LETTER SIZES SHOULD BE THE SAME AS ON THE EXISTING SIGNS. WHEN LANE ARROWS ARE TO BE COVERED, A BLANK OVERLAY SHOULD BE PLACED OVER EACH OF THE AFFECTED ARROWS. WHEN A RAMP IS BEING CLOSED, RATHER THAN USING A BLANK OVERLAY TO COVER THE ENTIRE SIGN, THE LEGEND "EXIT CLOSED" (W20-H15) SHOULD BE USED ON A DIAGONAL OVERLAY (LOWER LEFT TO UPPER RIGHT) ON THE SIGN. THE SIZE OF LETTERING ON OVERLAYS AND THE SIZE OF THE OVERLAY ARE INDICATED IN THE PLANS. THE MINIMUM LETTER SIZE FOR THE DIAGONAL "EXIT CLOSED" (W20-H15) OVERLAY SHALL BE 12" C.

ITEM 614, WORK ZONE CROSSOVER LIGHTING SYSTEM

THIS WORK SHALL CONSIST OF FURNISHING, ERECTING, OPERATING, MAINTAINING AND REMOVING A WORK ZONE LIGHTING SYSTEM FOR A SINGLE CROSSOVER, OR OVERLAPPING A PAIR OF CROSSOVERS. THE SYSTEM SHALL BE AS SHOWN ON TRAFFIC SCD MT-100.00. ALL MATERIALS AND CONSTRUCTION SHALL COMPLY WITH APPLICABLE PORTIONS OF 625 AND 725 EXCEPT: THE PERFORMANCE TEST OF 625.19F, AND CERTIFIED DRAWING REQUIREMENT OF 625.04, ARE WAIVED AND USED MATERIALS IN GOOD CONDITION ARE ACCEPTABLE.

POLES WHICH ARE NOT PROTECTED BY GUARDRAIL OR PORTABLE BARRIER SHALL BE LOCATED OUTSIDE THE CLEAR ZONE, AND SHOULD BE LOCATED AT LEAST 30 FEET (PREFERABLY 40 FEET) FROM THE EDGE OF PAVEMENT WHEN POSSIBLE.

ADDITIONAL POLE LINES, CABLES AND APPURTENANCES NECESSARY TO FURNISH POWER TO THE LIGHTING SYSTEM SHALL BE INCLUDED IN THIS ITEM. SERVICE POLES SHALL BE POSITIONED WITH THE SAME CONSTRAINTS AS THE LIGHTING POLES AS A MINIMUM.

CALCULATED
FGW
CHECKED
AVP

MAINTENANCE OF TRAFFIC NOTES

2021-09-29 - BU 05 - RELEASED FOR CONSTRUCTION PLANS

**SUM-76 / 77 / 8 -
8.24 / 9.74 / 0.00**

5
105

pw:\VANVAOPWINTO\parsons.com:Ohio State\Documents\Ohio State\Rehab\10 - Design\02329\M0T\Sheets\BU-05\02329_MNBUS005.dgn_Sheet 9/28/2021 12:57:17 PM apllpchuk

MAINTENANCE OF TRAFFIC SIGNAL/FLASHER INSTALLATION

THE CONTRACTOR SHALL BE RESPONSIBLE FOR MAINTAINING TRAFFIC SIGNAL/FLASHER INSTALLATIONS WITHIN THE PROJECT UNDER THE FOLLOWING CONDITIONS:

1. EXISTING SIGNAL/FLASHER INSTALLATIONS WHICH THE PLANS REQUIRE THE CONTRACTOR TO ADJUST, MODIFY, ADD ONTO OR REMOVE, OR WHICH THE CONTRACTOR ACTUALLY ADJUSTS, MODIFIES OR OTHERWISE DISTURBS. THE CONTRACTOR SHALL BE RESPONSIBLE FOR THE ENTIRE INSTALLATION (AT AN INTERSECTION) FROM THE TIME HIS OPERATIONS FIRST DISTURB THE INSTALLATION UNTIL THE INSTALLATION HAS BEEN SUBSEQUENTLY REMOVED OR MODIFIED AND THE WORK IS ACCEPTED.
2. NEW OR REUSED SIGNAL/FLASHER INSTALLATIONS OR DEVICES, INSTALLED BY THE CONTRACTOR. THE CONTRACTOR SHALL BE RESPONSIBLE FOR MAINTENANCE OF THESE FROM THE TIME OF INSTALLATION UNTIL THE WORK IS ACCEPTED.

THE CONTRACTOR SHALL CORRECT AS QUICKLY AS POSSIBLE ALL OUTAGES OR MALFUNCTIONS. HE SHALL PROVIDE THE MAINTAINING AGENCY AND THE ENGINEER SUCH ADDRESSES AND PHONE NUMBERS WHERE HIS MAINTENANCE FORCES CAN BE CONTACTED. THE CONTRACTOR SHALL PROVIDE ONE OR MORE PERSONS TO RECEIVE ALL CALLS AND DISPATCH THE NECESSARY MAINTENANCE FORCES TO CORRECT OUTAGES. SUCH A PERSON OR PERSONS MAY BE USED TO PERFORM OTHER DUTIES AS LONG AS PROMPT ATTENTION IS GIVEN TO THESE CALLS AND A PERSON IS READILY AVAILABLE CONTINUOUSLY 24 HOURS A DAY, 7 DAYS A WEEK. ALL LAMP OUTAGES, CABLE OUTAGES, ELECTRICAL FAILURES, EQUIPMENT MALFUNCTIONS AND MISALIGNED SIGNAL HEADS SHALL BE CORRECTED TO THE SATISFACTION OF THE ENGINEER WITH THE SIGNAL BACK TO SERVICE WITHIN FOUR HOURS AFTER THE CONTRACTOR HAS BEEN NOTIFIED OF THE OUTAGE.

IN THE EVENT NEW SIGNALS ARE DAMAGED PRIOR TO ACCEPTANCE, ALL DAMAGED EQUIPMENT EXCEPT POLES AND CONTROL EQUIPMENT SHALL BE REPLACED BY THE CONTRACTOR TO THE SATISFACTION OF THE ENGINEER WITH THE SIGNAL BACK IN SERVICE WITHIN 8 HOURS AFTER THE CONTRACTOR'S NOTIFICATION OF THE OUTAGE. THE CONTRACTOR SHALL ARRANGE FOR FULL TRAFFIC CONTROL UNTIL THE SIGNAL IS BACK IN OPERATION. IF POLES AND/OR CONTROL EQUIPMENT ARE DAMAGED AND MUST BE REPLACED, THE CONTRACTOR SHALL MAKE TEMPORARY REPAIRS AS NECESSARY TO BRING THE SIGNAL BACK INTO FULL OPERATION WITHIN THE ALLOWED 8-HOUR PERIOD, AND SHALL MAKE PERMANENT REPAIRS OR REPLACEMENT AS SOON THEREAFTER AS POSSIBLE.

NONE OF THE ABOVE SHALL BE CONSTRUED AS COLLECTIVE OR CONSECUTIVE OUTAGE TIME PERIODS AT ANY ONE LOCATION. THAT IS, WHERE MORE THAN ONE OUTAGE OCCURS AT ANY ONE LOCATION THEN THE ALLOTTED TIME LIMIT SHALL BE FOR THE WORST SINGLE OUTAGE.

WHERE OUTAGES ARE THE DIRECT RESULT OF A VEHICLE ACCIDENT THE RESPONSE OF THE CONTRACTOR SHALL BE AS OUTLINED ABOVE. THE CONTRACTOR SHALL BE RESPONSIBLE FOR COLLECTION OF ANY COMPENSATION FOR THIS WORK FROM THOSE PARTIES RESPONSIBLE FOR THE DAMAGE.

WHERE THE CONTRACTOR HAS FAILED TO, OR CANNOT RESPOND TO, AN OUTAGE OR SIGNAL EQUIPMENT MALFUNCTION, AT THESE LOCATIONS WITHIN HIS RESPONSIBILITY, WITHIN PERIODS AS SPECIFIED ABOVE, THE ENGINEER MAY INVOKE THE PROVISIONS OF SECTION 105.15

MAINTENANCE OF TRAFFIC SIGNAL/FLASHER INSTALLATION (CONT'D)

AND ANY SUBSEQUENT BILLINGS TO THE STATE OR THE CITY OF AKRON FOR POLICE SERVICES AND MAINTENANCE SERVICES BY CITY FORCES SHALL BE DEDUCTED FROM MONIES DUE OR TO BECOME DUE THE CONTRACTOR IN ACCORDANCE WITH PROVISIONS OF SECTION 105.15.

THE CONTRACTOR SHALL PROVIDE THE MAINTENANCE SERVICE ENTIRELY WITH HIS FORCES OR HE MAY CHOOSE TO ENTER INTO A COOPERATIVE UNDERSTANDING WITH THE LOCAL MAINTAINING AGENCY TO PROVIDE THE MAINTENANCE. THE CONTRACTOR SHALL INFORM THE ENGINEER, IN WRITING, OF THE MAINTENANCE METHOD SELECTED.

THE CONTRACTOR SHALL BE RESPONSIBLE FOR ANY DAMAGE TO ANY TRAFFIC SIGNAL COMPONENTS REQUIRED TO BE HANDLED DURING THE RELOCATION OF POLES AND REVISIONS TO THE SIGNAL SYSTEM. WHEN A TRAFFIC SIGNAL MUST BE TAKEN OUT OF SERVICE BY THE CONTRACTOR, DUE TO CONSTRUCTION PROCEDURES, THIS OUTAGE SHALL NOT EXCEED 2 HOURS AND SHALL NOT INCLUDE THE HOURS OF 6 AM TO 9 AM AND 3 PM TO 6 PM. ANY SIGNALIZED INTERSECTION, WHERE THE SIGNAL IS OUT OF SERVICE DUE TO CONSTRUCTION PROCEDURES, OR DUE TO AN OUTAGE OR MALFUNCTION OF EQUIPMENT AS DESCRIBED ABOVE, SHALL BE PROTECTED, BY THE CONTRACTOR, BY THE INSTALLATION OF TEMPORARY "STOP" SIGNS, EXCEPT FOR THE FOLLOWING INTERSECTIONS WHICH SHALL BE PROTECTED BY OFF-DUTY CITY OF AKRON POLICE, HIRED BY THE CONTRACTOR:

SEE HAUL ROUTES REFERENCED IN CMOTP PLAN, BU-01.

ANY VEHICULAR TRAFFIC SIGNAL HEAD, EITHER NEW OR EXISTING WHICH WILL BE OUT OF OPERATION SHALL BE COVERED IN THE MANNER DESCRIBED IN 632.25.

THE CONTRACTOR SHALL MAINTAIN COMPLETE RECORDS OF MALFUNCTIONS INCLUDING:

1. TIME OF NOTIFICATION OF MALFUNCTION;
2. TIME OF WORK CREWS ARRIVAL TO CORRECT THE MALFUNCTION;
3. ACTIONS TAKEN TO CORRECT THE MALFUNCTION, INCLUDING A LIST OF PARTS REPAIRED OR REPLACED;
4. A DIAGNOSIS OF REASON FOR THE MALFUNCTION AND PROBABILITY OF REOCCURRENCE;
5. TIME OF COMPLETION OF THE REPAIR AND SYSTEM RESTORED TO FULL SERVICE.

A COPY OF THESE RECORDS SHALL BE PROVIDED TO THE ENGINEER WITHIN THREE (3) WORKING DAYS FOLLOWING COMPLETION OF EACH REPAIR.

TRAFFIC INCIDENT MANAGEMENT (TIM) DURING MOT

Released for Construction
Thomas J Powell, PE
10/04/2021

OHIO TIM IS OHIO'S TRAFFIC INCIDENT MANAGEMENT PROGRAM WHICH IS COMMITTED TO MAINTAINING THE SAFE AND EFFECTIVE FLOW OF TRAFFIC DURING EMERGENCIES AS TO PREVENT FURTHER DAMAGE, INJURY OR UNDUE DELAY OF THE MOTORING PUBLIC. IN ADDITION TO COMPLYING WITH THE PROVISION OF OMUTCD CHAPTER 6I, CONTROL OF TRAFFIC THROUGH TRAFFIC INCIDENT MANAGEMENT AREAS, THE CONTRACTOR SHALL ACTIVELY PARTICIPATE IN TIM PLANNING AND IMPLEMENTATION AS OUTLINED BELOW.

1. SUPERINTENDENT SHALL IDENTIFY THE INDIVIDUAL PERSONS ON THE PROJECT WHO WILL, OR MAY NEED TO, PERFORM THE DUTIES HEREIN. AT A MINIMUM, INCLUDE THE SUPERINTENDENT, FOREMEN AND SUPERVISORS (OR EQUIVALENT) AS WELL AS THE WORKSITE TRAFFIC SUPERVISOR (WTS; IF APPLICABLE TO THE PROJECT). THESE INDIVIDUALLY IDENTIFIED PERSONS SHALL COLLECTIVELY BE KNOWN AS CONTRACTOR TRAFFIC INCIDENT MANAGEMENT (TIM) CONTACTS. NOTIFY THE PROJECT ENGINEER OF THE CONTRACTOR TIM CONTACTS (ALONG WITH CONTACT INFORMATION FOR EACH) AT OR BEFORE THE PRECONSTRUCTION MEETING.
2. SUPERINTENDENT SHALL NOTIFY THE ENGINEER IMMEDIATELY IF ANY CONTRACTOR TIM CONTACT IS ADDED, REMOVED OR THE CONTACT INFORMATION CHANGES OVER THE COURSE OF THE PROJECT.
3. PRIOR TO THE FIRST DAY OF WORK IN THE FIELD, EACH CONTRACTOR TIM CONTACT ON THE PROJECT SHALL HAVE ATTENDED AND SUCCESSFULLY COMPLETED OHIO TIM TRAINING PROVIDED BY THE DEPARTMENT OR DESIGNEE. TRAINING INFORMATION CAN BE FOUND AT WWW.OHIOTIM.COM.
4. SUPERINTENDENT, AT A MINIMUM, SHALL ATTEND AND ACTIVELY PARTICIPATE IN A DEPARTMENT SCHEDULED TIM MEETING BEFORE CONSTRUCTION WORK BEGINS AND BEFORE EACH PHASE CHANGE. THESE MEETINGS WILL RESULT IN A DEPARTMENT ISSUED PROJECT SPECIFIC TRAFFIC INCIDENT MANAGEMENT PLAN (TIMP). AT THE TIM MEETINGS THE ATTENDING CONTRACTOR TIM CONTACTS SHALL:
 - A. COLLABORATE WITH ODOT AND SAFETY FORCES;
 - B. SHARE PROJECT SPECIFIC DETAILS THAT IMPACT TIM RESPONDERS; AND
 - C. RECOMMEND WAYS TO INCORPORATE NECESSARY EMERGENCY ACCESS AND OTHER TIM ELEMENTS FOR TIM RESPONDERS GIVEN PROJECT SPECIFIC WORK BEING COMPLETED AND PROJECT SPECIFIC PHASING.
5. CONTRACTOR TIM CONTACTS SHALL IMPLEMENT COMPONENTS OF THE RESULTING TIMP (SUCH AS APPROVED EMERGENCY INGRESS/EGRESS POINTS, ETC), AS DIRECTED BY THE ENGINEER IN ACCORDANCE WITH 109.05.
6. CONTRACTOR TIM CONTACTS SHALL PERFORM, AT A MINIMUM, THE FOLLOWING FUNCTIONS WHEN AN INCIDENT/CRASH OCCURS:
 - A. IF OBSERVED OR PRESENT WHEN OCCURS, CALL 911 AND THEN NOTIFY THE TRAFFIC MANAGEMENT CENTER (TMC) TO PROVIDE THE FOLLOWING:
 - I. LOCATION, INCLUDING MILEPOST NUMBER AND DIRECTION OF TRAVEL
 - II. NUMBER AND TYPE OF VEHICLES INVOLVED, IF KNOWN
 - III. ESTIMATED EXTENT OF DAMAGE OR INJURY, IF KNOWN

ISSUE RECORD:		
NO.	DATE	DESCRIPTION

TRAFFIC INCIDENT MANAGEMENT (TIM) DURING MOT (CONT'D)

- IV. ESTIMATED NUMBER OF PATIENTS INVOLVED, IF KNOWN
 - V. ANY POTENTIAL HAZARDOUS CONDITIONS, IF KNOWN
 - VI. THE PLACARD NUMBER ON ANY HAZARDOUS MATERIALS PLACARD FROM A SAFE DISTANCE, IF APPLICABLE AND VISIBLE
- B. FOLLOWING AN INCIDENT/CRASH:
- I. INITIATE TRAFFIC MANAGEMENT/PROVIDE TEMPORARY TRAFFIC CONTROL AS INDICATED IN THE TIMP, AS DIRECTED BY THE ENGINEER IN ACCORDANCE WITH 109.05.
 - II. RECOMMEND ROADWAY REPAIR NEEDS.
 - III. PROVIDE REPAIR RESOURCES AND INITIATE REPAIRS, AS DIRECTED BY THE ENGINEER IN ACCORDANCE WITH 109.05.
 - IV. ATTEND AND PARTICIPATE IN AN AFTER ACTION REVIEW (AAR).

2021-09-29 - BU 05 - RELEASED FOR CONSTRUCTION PLANS

MAINTENANCE OF TRAFFIC NOTES

SUM-76 / 77 / 8-8.24 / 9.74 / 0.00

6
105

dw:\VANVAIPWINTO\parsons.com:Ohio State\Documents\DB-Akron Beltway Rehab\10 - Design\02329\M01\Sheets\BU-05\02329_MNBUS006.dgn Sheet 9/28/2021 12:57:22 PM aplipcnuk

WORKSITE TRAFFIC SUPERVISOR

SUBJECT TO APPROVAL OF THE ENGINEER, THE CONTRACTOR SHALL EMPLOY AND IDENTIFY (SOMEONE OTHER THAN THE SUPERINTENDENT) A CERTIFIED WORKSITE TRAFFIC SUPERVISOR (WTS) BEFORE STARTING WORK IN THE FIELD. THE WTS SHALL BE CERTIFIED FROM ONE OF THE FOLLOWING ORGANIZATIONS:

1. AMERICAN TRAFFIC SAFETY SERVICE ASSOCIATION (ATSSA), PHONE NUMBER 1-800-272-8772, CERTIFIED TRAFFIC CONTROL SUPERVISOR (TCS).
2. THE OHIO CONTRACTORS ASSOCIATION, TRAFFIC CONTROL SUPERVISOR (OCA/TCS) WORK ZONE CLASS, ONLY IF TAKEN AFTER MAY 5, 2004, PHONE NUMBER 1-800 229-1388.
3. OHIO LABORERS' TRAINING, TRAFFIC CONTROL SUPERVISORS CLASS, PHONE NUMBER 1-740-599-7915.

A COPY OF EACH WTS'S CERTIFICATION AND 24-HOUR CONTACT INFORMATION SHALL BE PROVIDED TO THE ENGINEER AT THE PRECONSTRUCTION CONFERENCE. IF THE DESIGNATED WTS WILL NOT BE AVAILABLE FULL TIME (24/7), THE CONTRACTOR MAY DESIGNATE AN ALTERNATE WTS TO BE AVAILABLE WHEN THE PRIMARY IS OFF DUTY. EACH WTS SHALL HAVE A WTS CERTIFICATION CONTAINING THE DATE OF ISSUE AND SHALL BE FROM ANY OF THE APPROVED ORGANIZATIONS. AT THE TIME OF THE PRECONSTRUCTION CONFERENCE, THE WTS CERTIFICATION DATE OF ISSUE SHALL BE WITHIN THE 5 YEARS PRIOR TO THE ORIGINAL COMPLETION DATE OF THE PROJECT.

THE WTS POSITION HAS THE RESPONSIBILITY OF MONITORING TRAFFIC CONTROL DEFICIENCIES FOR THE ENTIRE WORK ZONE. THE DUTIES OF THE WTS ARE AS FOLLOWS:

1. BE AVAILABLE ON A 24-HOUR PER DAY BASIS, AND BE ABLE TO BE ON SITE FOR ALL EMERGENCY TRAFFIC CONTROL NEEDS WITHIN ONE HOUR OF NOTIFICATION BY POLICE OR PROJECT STAFF AND BE PREPARED TO EFFECT CORRECTIVE MEASURES IMMEDIATELY ON EXISTING WORK ZONE TRAFFIC CONTROL DEVICES.
2. ATTEND PRECONSTRUCTION MEETING AND ALL PROJECT MEETINGS WHERE TRAFFIC CONTROL MANAGEMENT IS DISCUSSED.
3. BE AVAILABLE FOR MEETINGS OR DISCUSSIONS WITH THE ENGINEER UPON REQUEST OR WITHIN 36 HOURS.
4. COORDINATE A TRAFFIC INCIDENT MANAGEMENT MEETING EACH YEAR BEFORE CONSTRUCTION WORK BEGINS WITH ODOT AND THE SAFETY FORCES THAT WILL RESPOND TO INCIDENTS ON THE PROJECT. ITEMS TO BE DISCUSSED WILL BE THE:
 - A. TRAFFIC INCIDENT MANAGEMENT PLAN (TIMP);
 - B. EMERGENCY RESPONSE AND NOTIFICATION;
 - C. PROJECT WORK/PHASING CONCERNS (E.G., RAMP CLOSURES); AND
 - D. RESPONDERS CONCERNS.
5. BE AWARE OF, AND COORDINATE IF NECESSARY, ALL TRAFFIC CONTROL OPERATIONS, INCLUDING THOSE OF SUBCONTRACTORS AND SUPPLIERS.
6. COORDINATE PROJECT ACTIVITIES WITH ALL LAW ENFORCEMENT OFFICERS (LEOS). A WTS SHALL ALSO BE THE MAIN CONTACT PERSON WITH THE LEOS WHILE THEY ARE ON THE PROJECT.

WORKSITE TRAFFIC SUPERVISOR (CONT'D)

7. COORDINATE MEETINGS WITH ODOT PERSONNEL, LEOS AND OTHER APPLICABLE ENTITIES BEFORE EACH PLAN PHASE SWITCH TO DISCUSS WORK ZONE TRAFFIC CONTROL.
8. ENSURE COMPLIANCE WITH THE CONTRACT DOCUMENTS FOR SIGNS, BARRICADES, TEMPORARY CONCRETE BARRIER, PAVEMENT MARKINGS, PORTABLE MESSAGE SIGNS, AND OTHER TRAFFIC CONTROL DEVICES ON A DAILY BASIS; AND FACILITATE ANY CORRECTIVE ACTION NECESSARY.
9. NOTIFY THE CONTRACTOR OF THE NEED FOR CLEANING AND MAINTENANCE OF ALL TRAFFIC CONTROL DEVICES, INCLUDING THE COVERING AND REMOVAL OF INAPPLICABLE SIGNS.
10. INSPECT, EVALUATE, PROPOSE NECESSARY MODIFICATIONS TO, AND DOCUMENT THE EFFECTIVENESS OF, THE TRAFFIC CONTROL DEVICES AND/OR TRAFFIC OPERATIONS ON A DAILY BASIS (7 DAYS A WEEK). IN ADDITION, A WEEKLY NIGHT INSPECTION OF THE WORK ZONE SETUP FOR DAYTIME WORK OPERATIONS; AND ONE DAYTIME INSPECTION PER WEEK FOR NIGHTTIME PROJECTS. THIS SHALL INCLUDE (BUT NOT BE LIMITED TO) DOCUMENTATION ON THE FOLLOWING PROJECT EVENTS:
 - A. INITIAL TRAFFIC CONTROL SETUP (DAY AND NIGHT REVIEW).
 - B. DAILY TRAFFIC CONTROL SETUP AND REMOVAL.
 - C. WHEN CONSTRUCTION STAGING CAUSES A CHANGE IN THE TRAFFIC CONTROL SETUP.
 - D. CRASH OCCURRENCES WITHIN THE CONSTRUCTION AREA.
 - E. REMOVAL OF TRAFFIC CONTROL DEVICES AT THE END OF A PHASE OR PROJECT.
 - F. ALL OTHER EMERGENCY TRAFFIC CONTROL NEEDS.
11. COMPLETE THE DEPARTMENT APPROVED LONG TERM INSPECTION FORM (CA-D-8) AFTER EACH INSPECTION AS REQUIRED IN #10 AND SUBMIT IT TO THE ENGINEER THE FOLLOWING WORK DAY. THESE REPORTS SHALL INCLUDE A CHECKLIST OF ALL TRAFFIC CONTROL MAINTENANCE ITEMS TO BE REVIEWED. A COPY OF THE FORM WILL BE PROVIDED AT THE PRE-CONSTRUCTION MEETING. ANY DEFICIENCIES OBSERVED SHALL BE NOTED, ALONG WITH RECOMMENDED CORRECTIVE ACTIONS AND THE DATES BY WHICH SUCH CORRECTIONS WERE, OR WILL BE, COMPLETED. A COPY OF THIS DOCUMENT CAN BE FOUND IN THE CURRENT REVISION OF THE DEPARTMENT OF TRANSPORTATION CONSTRUCTION INSPECTION FORMS MANUAL.
12. VERIFY THAT ALL FLAGGING OPERATIONS ARE BEING CONDUCTED PER THE OHIO MANUAL OF UNIFORM TRAFFIC CONTROL DEVICES.
13. HAVE COPIES OF THE ODOT TEMPORARY TRAFFIC CONTROL MANUAL AND APPLICABLE STANDARDS AND SPECIFICATIONS INCLUDED IN THE CONTRACT DOCUMENTS AVAILABLE AT ALL TIMES ON THE PROJECT.
14. IDENTIFY AND CONTACT ALL POSSIBLE RESPONSE PERSONNEL; PREPLAN AND KEEP AN UPDATED ROSTER WITH PHONE NUMBERS:
 - A. FEDERAL, STATE, AND LOCAL TRANSPORTATION AGENCIES (TRAFFIC MANAGEMENT CENTER);
 - B. REGIONAL, COUNTY OR LOCAL 911 DISPATCH; AND
 - C. TOWING AND RECOVERY PROVIDERS.

WORKSITE TRAFFIC SUPERVISOR (CONT'D)

15. COMPLY WITH THE PROVISIONS OF OMUTCD CHAPTER 61, CONTROL OF TRAFFIC THROUGH TRAFFIC INCIDENT MANAGEMENT AREAS.
16. PROPOSE A RESPONSE/ACTION PLAN TO:
 - A. ESTABLISH ALTERNATE ROUTE PLANS PER THE PROVIDED ODOT PLAYBOOK;
 - B. REMOVE TRAFFIC DEMAND FROM IMPACTED ROADWAYS;
 - C. DIVERT TRAFFIC TO ROUTES THAT CAN ACCOMMODATE DEMANDS;
 - D. DETOUR TRAFFIC AWAY FROM SENSITIVE AREAS (SUCH AS SCHOOLS, HOSPITALS, ETC.);
 - E. DISCUSS METHODS OF DETERMINING A STAGING AREA FOR RESPONDERS WITHIN OR NEAR THE CONSTRUCTION ZONE; AND
 - F. DISCUSS METHODS OF DEVELOPING INGRESS AND EGRESS SITES WITHIN THE CONSTRUCTION ZONE. THE RESPONSE/ACTION PLAN SHALL BE SUBMITTED TO ODOT FOR ACCEPTANCE BEFORE THE CONTRACTOR'S FIRST DAY OF WORK.
17. PERFORM, AT A MINIMUM, THE FOLLOWING FUNCTIONS IN INCIDENT DETECTION AND VERIFICATION:
 - A. CALL 911/ NOTIFY TRAFFIC MANAGEMENT CENTER AND PROVIDE THE FOLLOWING:
 - I. LOCATION - INCLUDING MILEPOST NUMBER AND DIRECTION OF TRAVEL.
 - II. NUMBER AND TYPE OF VEHICLES INVOLVED.
 - III. ESTIMATED EXTENT OF DAMAGE OR INJURY.
 - IV. ESTIMATED NUMBER OF PATIENTS INVOLVED.
 - V. ANY POTENTIAL HAZARDOUS CONDITIONS.
 - VI. THE PLACARD NUMBER ON ANY HAZARDOUS MATERIALS PLACARD FROM A SAFE DISTANCE.
 - B. INITIATE TRAFFIC MANAGEMENT / PROVIDE TRAFFIC CONTROL.
 - C. ASSIST MOTORIST WITH DISABLED VEHICLES.
 - D. RECOMMEND ROADWAY REPAIR NEEDS.
 - E. PROVIDE REPAIR RESOURCES.
18. ATTEND POST-INCIDENT DEBRIEFINGS IF REQUIRED.

SHOULD THE CONTRACTOR'S FAILURE TO PERFORM ANY OF THE DUTIES DESCRIBED ABOVE RESULT IN A MAINTENANCE OF TRAFFIC SAFETY ISSUE, THE DEPARTMENT WILL DEDUCT THE PRORATED DAILY AMOUNT FOR ITEM 614 MAINTENANCE OF TRAFFIC FROM THE CONTRACTOR'S NEXT SCHEDULED ESTIMATE. IF THREE OR MORE FAILURES TO PERFORM THE DUTIES SET FORTH ABOVE OCCUR, THE WTS SHALL BE IMMEDIATELY REMOVED FROM THE WORK IN ACCORDANCE WITH C&MS 108.05. UPON REMOVAL THE ENGINEER SHALL NOTIFY ODOT CENTRAL OFFICE (WTSPREQUALIFICATION@DOT.OHIO.GOV) TO REGISTER A REMOVAL AGAINST THE STATEWIDE PREQUALIFICATION FOR THE PRIMARY WTS. THREE REMOVALS SHALL CAUSE STATEWIDE DISQUALIFICATION FOR ANY PREVIOUSLY PREQUALIFIED WTS.

CONSTRUCTION ACCESS

CONSTRUCTION ACCESS WILL BE PROVIDED PER THE STANDARD DRAWING, OR IN COORDINATION WITH THE DISTRICT UPON APPROVAL OF THE PLANS

Released for Construction
Thomas J Powell, PE
10/04/2021

ISSUE RECORD:		
NO.	DATE	DESCRIPTION

2021-09-29 - BU 05 - RELEASED FOR CONSTRUCTION PLANS

CALCULATED
FGW
CHECKED
AVP

MAINTENANCE OF TRAFFIC NOTES

SUM-76 / 77 / 8 -
8.24 / 9.74 / 0.00

7
105

pw:\VANVAOPWINTO\parsons.com:Ohio State\Documents\DB-Akron Beltway Rehab\10 - Design\02329\M0T\Sheets\BU-05\02329.MNBU5006A.dgn Sheet 9/28/2021 12:57:26 PM apljipchuk

SEQUENCE OF CONSTRUCTION

PHASE 3A

STEP 1

TRAFFIC:

1. CLOSE RAMPS J, M, SW, W10, R, V AND O
2. SHIFT ALL IR 76/77 SB LANES TO OUTSIDE UTILIZING SHOULDER FROM WEST OF EAST AVENUE TO EAST OF PRINCETON STREET.
3. SHIFT ALL IR 76/77 NB LANES TO INSIDE UTILIZING SHOULDER FROM WEST OF EAST AVENUE TO EAST OF PRINCETON STREET.
4. CROSSOVER INSIDE NB LANE OF IR 76/77 TO INSIDE SB LANE OF IR 76/77 JUST WEST OF EAST AVENUE TO EAST OF PRINCETON STREET.
5. SHIFT IR 76/77 NB LANES TO INSIDE UTILIZING SHOULDER FROM EAST OF GRANT STREET TO CENTRAL INTERCHANGE.

CONSTRUCTION:

1. OUTSIDE LANES OF IR 76/77 NB FROM WEST OF EAST AVENUE TO EAST OF PRINCETON STREET.
2. OUTSIDE LANES OF IR 76/77 NB FROM EAST OF GRANT STREET TO CENTRAL INTERCHANGE.
3. RAMPS J, M, W10, R AND O. OUTSIDE OF RAMP U.

STEP 2

TRAFFIC:

1. RAMP W10 OPEN.

PHASE 3B

TRAFFIC:

1. SHIFT IR 76 WB LANES TO OUTSIDE UTILIZING SHOULDER FROM EAST OF GRANT STREET TO EAST OF BROWN STREET.

CONSTRUCTION:

1. INSIDE LANES OF IR 76 WB FROM EAST OF GRANT STREET TO EAST OF BROWN STREET.
2. RAMPS O AND R. INSIDE OF RAMP U.
3. OUTSIDE OF IR 76 WB FROM WEST OF INMAN STREET TO EAST OF HOLY CROSS BOULEVARD.

PHASE 4A

TRAFFIC:

1. SHIFT ALL IR 76/77 SB LANES TO OUTSIDE UTILIZING SHOULDER FROM WEST OF EAST AVENUE TO EAST OF PRINCETON STREET.
2. SHIFT ALL IR 76/77 NB LANES TO OUTSIDE UTILIZING SHOULDER FROM WEST OF EAST AVENUE TO PRINCETON STREET.
3. SHIFT IR 76/77 SB LANES TO INSIDE UTILIZING SHOULDER FROM EAST OF GRANT STREET TO CENTRAL INTERCHANGE.
4. SHIFT IR 76 WB LANES TO OUTSIDE UTILIZING SHOULDER FROM CENTRAL INTERCHANGE TO WEST OF ARLINGTON STREET.
5. RAMPS J AND M OPEN.

CONSTRUCTION:

1. INSIDE OF IR 76/77 NB AND SB FROM WEST OF EAST AVENUE TO EAST OF PRINCETON STREET.
2. OUTSIDE OF IR 76/77 SB FROM WEST OF SUMNER STREET TO CENTRAL INTERCHANGE AND RAMP M.
3. INSIDE OF IR 76 WB FROM WEST OF INMAN STREET TO EAST OF HOLY CROSS BOULEVARD.

PHASE 4B

STEP 1

TRAFFIC:

1. SHIFT IR 76/77 SB LANES TO OUTSIDE UTILIZING SHOULDER FROM WEST OF WOLF LEDGES PARKWAY TO CENTRAL INTERCHANGE.

CONSTRUCTION:

1. INSIDE IR 76/77 SB FROM WEST OF SUMNER STREET TO CENTRAL INTERCHANGE AND RAMP Q.

STEP 2

TRAFFIC:

1. REDUCE IR 76 EB TO ONE LANE.
2. SHIFT IR 76 EB LANE TO THE OUTSIDE UTILIZING SHOULDER FROM WEST OF BROWN STREET TO EAST OF INMAN STREET.

CONSTRUCTION:

1. INSIDE IR 76 EB FROM EAST OF BROWN STREET TO WEST OF INMAN STREET.

PHASE 5A

STEP 1

TRAFFIC:

1. SHIFT IR 76/77 SB LANES TO INSIDE UTILIZING SHOULDER FROM WEST OF EAST AVENUE TO EAST OF PRINCETON STREET.
2. SHIFT IR 76 EB TO OUTSIDE UTILIZING SHOULDER FROM WEST OF BROWN STREET TO INMAN STREET.
3. CLOSE RAMPS EN, G, J, K, L AND W11.

CONSTRUCTION:

1. OUTSIDE IR 76/77 SB LANES FROM WEST OF EAST AVENUE TO PRINCETON STREET.
2. INSIDE IR 76 EB FROM EAST OF BROWN STREET TO WEST OF INMAN STREET.
3. RAMPS EN, G, J, K, L AND W11.

STEP 2

TRAFFIC:

1. SHIFT IR 76 EB TO INSIDE UTILIZING SHOULDER FROM WEST OF BROWN STREET TO INMAN STREET.

CONSTRUCTION:

1. OUTSIDE IR 76 EB FROM EAST OF BROWN STREET TO WEST OF INMAN STREET.

PHASE 5B

TRAFFIC:

1. SHIFT IR 76 WB LANE TO OUTSIDE UTILIZING SHOULDER FROM WEST OF BROWN STREET TO EAST OF INMAN STREET.

CONSTRUCTION:

1. INSIDE IR 76 WB FROM EAST OF BROWN STREET TO WEST OF INMAN STREET.

PHASE 6A

TRAFFIC:

1. SHIFT IR 76 WB LANE TO INSIDE UTILIZING SHOULDER FROM WEST OF BROWN STREET TO EAST OF INMAN STREET.

CONSTRUCTION:

1. OUTSIDE IR 76 WB FROM EAST OF BROWN STREET TO WEST OF INMAN STREET.

Released for Construction
Thomas J Powell, PE
10/04/2021

ISSUE RECORD:		
NO.	DATE	DESCRIPTION

CALCULATED	FGW	CHECKED	AVP
------------	-----	---------	-----

MAINTENANCE OF TRAFFIC NOTES

2021-09-29 -- BU 05 -- RELEASED FOR CONSTRUCTION PLANS

**SUM-76 / 77 / 8-
8.24 / 9.74 / 0.00**

8
105

p:\VANVAIPWINTO\parsons.com\Ohio State\Documents\DB-Akron_Beltway_Rehab\10 - Design\02329\M0T\Sheets\BU-05\02329_MNB\5007.dgn Sheet 9/28/2021 12:57:30 PM aplipchuk

Released for Construction
 Thomas J Powell, PE
 10/04/2021

ISSUE RECORD:		
NO.	DATE	DESCRIPTION

Table - Lane / Ramp Closure Matrix

Phase	Roadway/Ramp	Approximate Workzone Limits	Exist # Mainline Thru Lanes	Min. # MOT Mainline Thru Lanes	Required System Ramp Closure	Required Concurrent Local Ramp Closure	Maximum Lane/Ramp Closure Duration(s)	Concurrent 2-lane Operation Not Permissible	Concurrent Ramp Closure Not Permissible	Required Temporary Improvements
1A, 1B	8NB/SB	77 to Perkins St	3	PLCC	N/A	N/A	N/A	N/A	N/A	N/A
2A	77NB/77SB (construct outside improvements)	Vernon Odom Blvd to west of East Ave	6	4	76EB to 77NB 76EB to 76EB (at 77) 77SB to 76WB 277WB to 76EB 76EB to 76EB (at 277) 76WB/77NB to 76WB (permissible)	Kenmore Blvd to 76EB 22 nd St to 76WB (on ramps) 261 to 77SB	150-Day	77NB from Waterloo Rd to 8 77SB from Waterloo Rd to 8	77NB to 76WB 76EB to 77SB	Restripe 77SB to maintain 4 lanes south of Cole Ave to 277 (also applies to inside improvements)
2B	77NB/77SB (construct inside improvements)	Vernon Odom Blvd to west of East Ave	6	0	8SB to 76WB/77NB 77NB to 76WB/77NB	N/A		77NB from Waterloo Rd to 8 77SB from Waterloo Rd to 8	77NB to 76EB 76EB to 77SB	Restripe 76WB Ramp (at 77) to create 2 lane exit (merge to 1 lane on ramp)
5A	8SB to 76EB	Length of Ramps	N/A	N/A	Lane S	N/A	Lane S: 45-Day	N/A	N/A	N/A
5A	Ramp R (76EB to 8 NB)	Ramp	1	1	Yes	N/A	Ramp R: 75-Day	77NB from Waterloo Rd to 8	N/A	N/A
	Ramp N (76WB to 77 SB)	Ramp	1	1	Yes	N/A	Ramp N: 60-Day	76WB west of East Ave to Princeton St	N/A	N/A
4A, 4B, 5A	76EB	west of East Ave to Princeton St	3	2	76EB to 76EB (at 77) 76EB to 76EB (at 277) 76EB to 77SB	East Ave On-ramp (EB) South St On-ramp	640-Day	77NB from Waterloo Rd to 8 76 WB from East Ave to Princeton St	77NB to 76WB 77NB to 76EB	N/A
		Sumner St to Inman St bridge	2	1						
5A, 5B	77SB Ramp M (76EB to 77SB)	Waterloo Rd to 8	3	2	76EB to 77SB 77SB to 277WB 76EB to 76EB (at 77) 76EB to 76EB (at 277)	Wilbeth Rd On-ramp (SB) East Ave On-ramp (EB)	640-Day Wilbeth (210-Day) 77SB-277WB (210-Day*)	77NB from Waterloo Rd to 8	8SB to 76WB	(*) 76WB/77NB: Restripe to maintain 4 lanes from Main St to 76WB Off-ramp; Exit 2 lanes at 76WB Off-ramp (inside merge vicinity of Morse St overpass); Reduce 76EB-77NB ramp to 1 lane
4A, 4B	76EB	Allyn St to Ramp M	4							
3A	76WB	west of East Ave to Princeton St	3	2	77NB to 76WB 8SB to 76WB (inside work area) 59SB to 76WB (outside work area)	East Ave Off-ramp (outside work area)	640-Day 59SB to 76WB: 320-Day	76EB from East Ave to Princeton St	76EB to 77NB 77SB to 277WB	N/A
3A, 3B	76WB	77NB Ramp T (77NB to 76EB) Lane O (77NB to 76WB)	3	2	77NB to 76EB 77NB to 76WB	Waterloo Rd, Wilbeth Rd & Archwood Ave On-ramps (NB)	640-Day 77NB-76EB (210-Day) Service Ramps (210-Day)	77SB from Waterloo Rd to 8	76EB to 77NB 76EB to 76EB (at 77)	N/A
		Brown St to Sumner St	4							
5A, 6B	76WB	west of 8 (approx. STA 530+75) to Inman St	2	1	N/A	N/A	60-Day	77SB from Waterloo Rd to 8	76WB to 77SB (new flyover shall be open before lane reduction is permitted)	N/A
3A, 3B, 4A	76WB	East of Inman St	3	PLCC	N/A	N/A	N/A	N/A	N/A	N/A

2021-09-29 - BU 05 - RELEASED FOR CONSTRUCTION PLANS

MAINTENANCE OF TRAFFIC NOTES
 CALCULATED
 FGW
 CHECKED
 AVP

SUM-76 / 77 / 8-
 8.24 / 9.74 / 0.00
 9
 105

ISSUE RECORD:		
NO.	DATE	DESCRIPTION

d:\v\ANVAD01PWINT01\parsons.com\Ohio State Documents\Beltway Rehab\10 - Design\102329\MOT\Sheets\BU-05\102329_MBU5P3A-0 Sheet 9/28/2021 12:57:35 PM apilpchnk

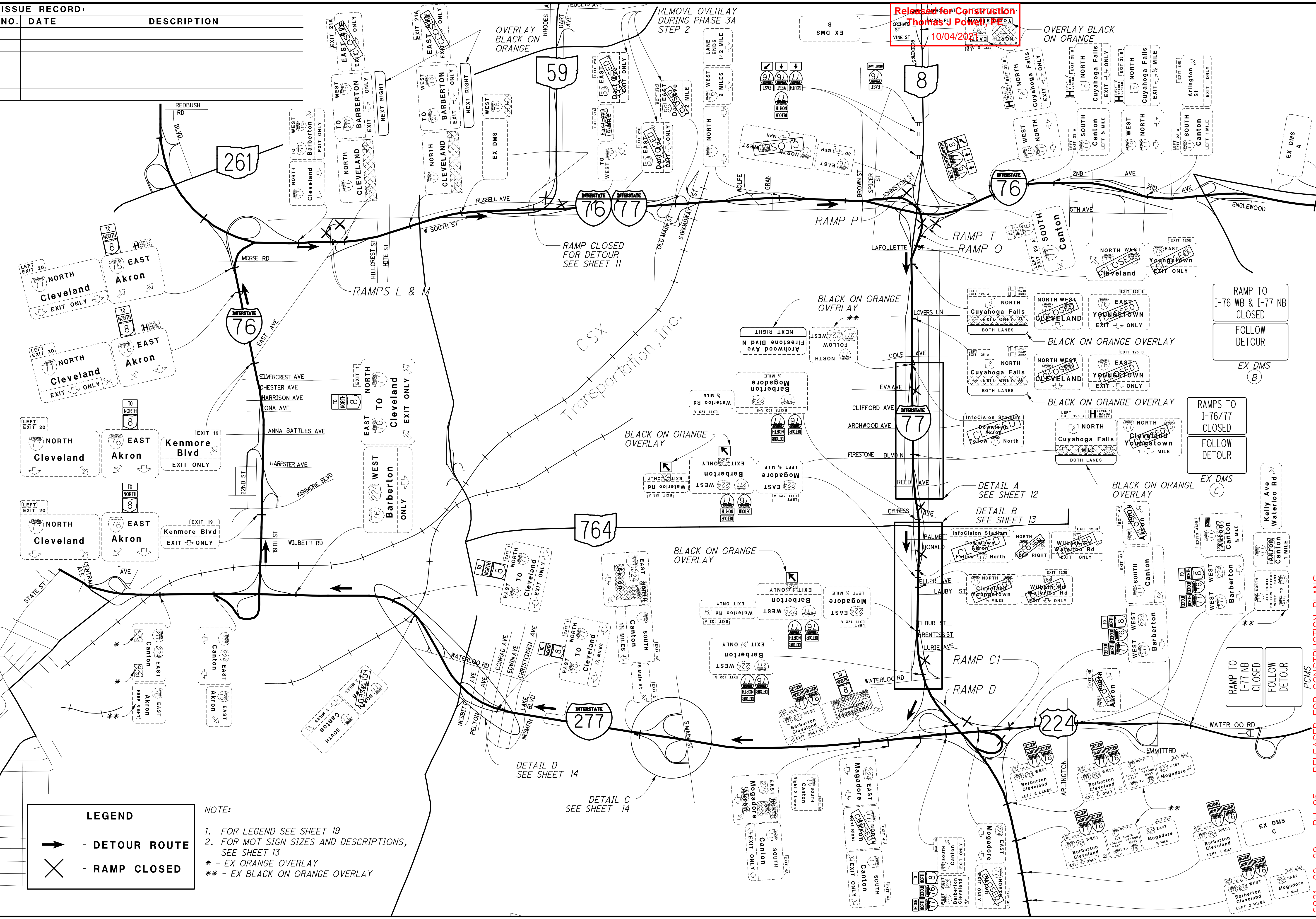

LEGEND

→ - DETOUR ROUTE

✕ - RAMP CLOSED

NOTE:

- FOR LEGEND SEE SHEET 19
- FOR MOT SIGN SIZES AND DESCRIPTIONS, SEE SHEET 13

* - EX ORANGE OVERLAY
 ** - EX BLACK ON ORANGE OVERLAY

Released for Construction
 Thomas J. Powers, Inc.
 10/04/2021

CALCULATED BER CHECKED AVP

2000'
HORIZONTAL SCALE IN FEET

2021-09-29 - BU 05 - RELEASED FOR CONSTRUCTION PLANS
RAMP C1, D, O, P, T CLOSURE (PHASE 3A)

SUM-76 / 77 / 8 -
8.24 / 9.74 / 0.00

PCMS
10

105

d:\VANVAOP\WINTO\parsons.com\Ohio State\Documents\DB-Akron Beltway Rehab\10 - Design\02329\001\Sheets\BU-05\02329_MDBU5P3A-59.dgn Sheet 9/28/2021 12:51:40 PM aplipchuk

Released for Construction
Thomas J Powell, PE
10/04/2021

ISSUE RECORD:		
NO.	DATE	DESCRIPTION

CALCULATED BER CHECKED AVP

0 750 1500

375 HORIZONTAL SCALE IN FEET

RAMP SR 59 WB DETOUR (PHASE 3A & 3B)

DETOUR MAP

2021-09-29 - BU 05 - RELEASED FOR CONSTRUCTION PLANS

SUM-76 / 77 / 8 - 8.24 / 9.74 / 0.00

11 / 105

NOTES:
1. FOR LEGEND SEE SHEET 19

LEGEND

➔ - DETOUR ROUTE

✕ - RAMP (ROAD) CLOSED

1 ROAD CLOSED - CLOSE WB 59
R11-2-48

2 DETOUR AHEAD
W20-2-36

3 *
M4-8-30 M4-8-30
M3-4-36 M3-4-36
M1-1-48-2 M1-1-48-2
M3-1-36 M3-1-36
M1-1-48-2 M1-1-48-2
M5-1-30 M6-1-30

4 *
M4-8-30 M4-8-30
M3-4-36 M3-4-36
M1-1-48-2 M1-1-48-2
M3-1-36 M3-1-36
M1-1-48-2 M1-1-48-2
M6-3-30 M6-3-30

5 *
M4-8-30 M4-8-30
M3-1-36 M3-1-36
M1-1-48-2 M1-1-48-2
M3-1-36 M3-1-36
M1-1-48-2 M1-1-48-2
M5-1-30 M6-1-30

6 *
M4-8-30 M4-8-30
M3-4-36 M3-4-36
M1-1-48-2 M1-1-48-2
M6-2-30

7 *
M4-8-30 M4-8-30
M3-1-36 M3-1-36
M1-1-48-2 M1-1-48-2
M5-1-30 M6-1-30

* - INSTALL SIGNS USING 100 FT SPACING

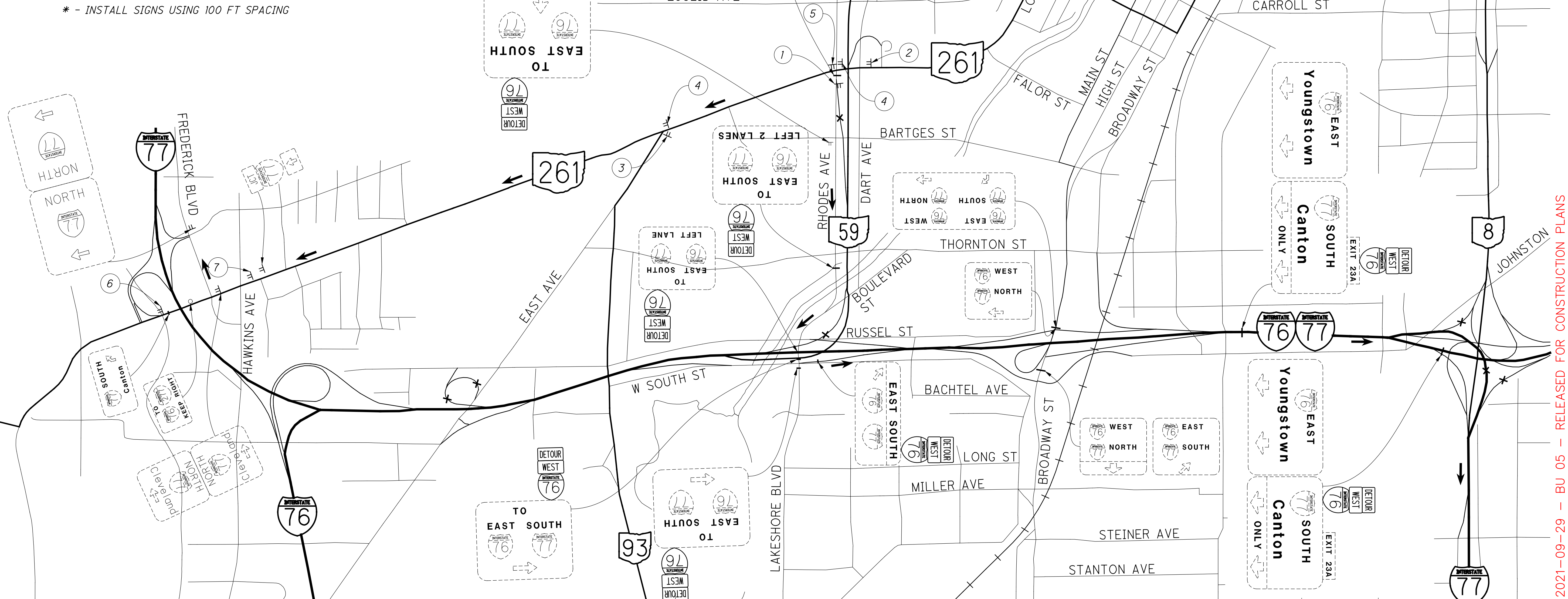

Released for Construction
 Thomas J Powell, PE
 10/04/2021

ISSUE RECORD:		
NO.	DATE	DESCRIPTION

NOTES:
 1. FOR LEGEND SEE SHEET 19
 2. FOR SR 764 DETOUR, SEE SHEET 13

CALCULATED
 BER
 CHECKED
 AVP

0 400 800
 HORIZONTAL
 SCALE IN FEET

DETAIL A DETOUR (PHASES 3A & 3B)
 DETOUR MAP

SUM-76/77/8-
 8.24/9.74/0.00

LEGEND

➔ - DETOUR ROUTE

X - RAMP (ROAD) CLOSED

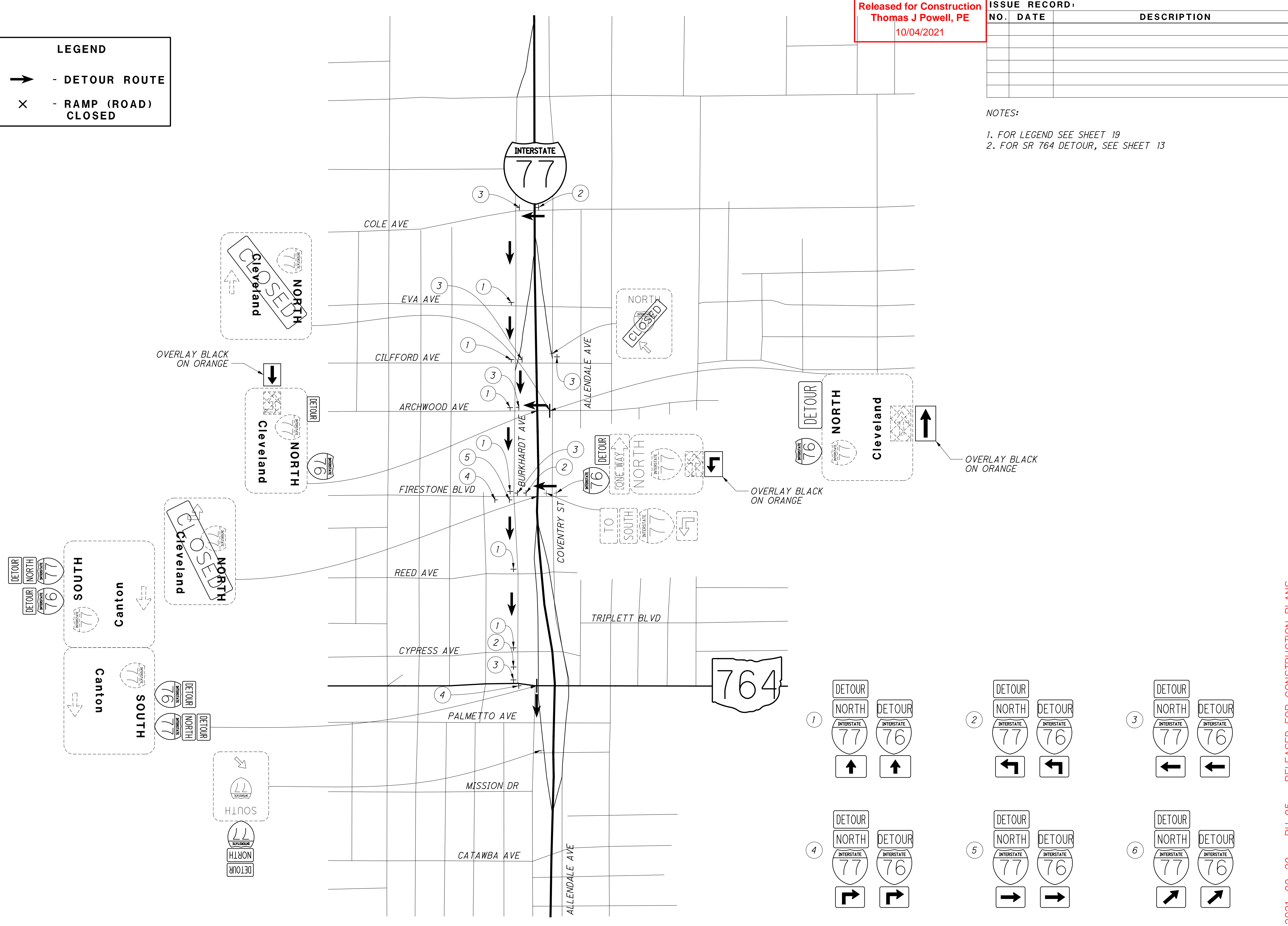

1

DETOUR NORTH INTERSTATE 77	DETOUR NORTH INTERSTATE 76
↑	↑

2

DETOUR NORTH INTERSTATE 77	DETOUR NORTH INTERSTATE 76
↶	↶

3

DETOUR NORTH INTERSTATE 77	DETOUR NORTH INTERSTATE 76
↶	↶

4

DETOUR NORTH INTERSTATE 77	DETOUR NORTH INTERSTATE 76
↷	↷

5

DETOUR NORTH INTERSTATE 77	DETOUR NORTH INTERSTATE 76
➔	➔

6

DETOUR NORTH INTERSTATE 77	DETOUR NORTH INTERSTATE 76
↗	↗

d:\va\vaipwintol\parsons.com\Ohio State\Documents\VB-Akron Beltway Rehab\10 - Design\02329\M0T\Sheets\BU-05\02329.MDBU5P3A-DETAIL B.dgn Sheet 9/28/2021 12:57:49 PM aplilpchuk

Released for Construction
 Thomas J Powell, PE
 10/04/2021

ISSUE RECORD:		
NO.	DATE	DESCRIPTION

CALCULATED BER
 CHECKED AVP

HORIZONTAL SCALE IN FEET

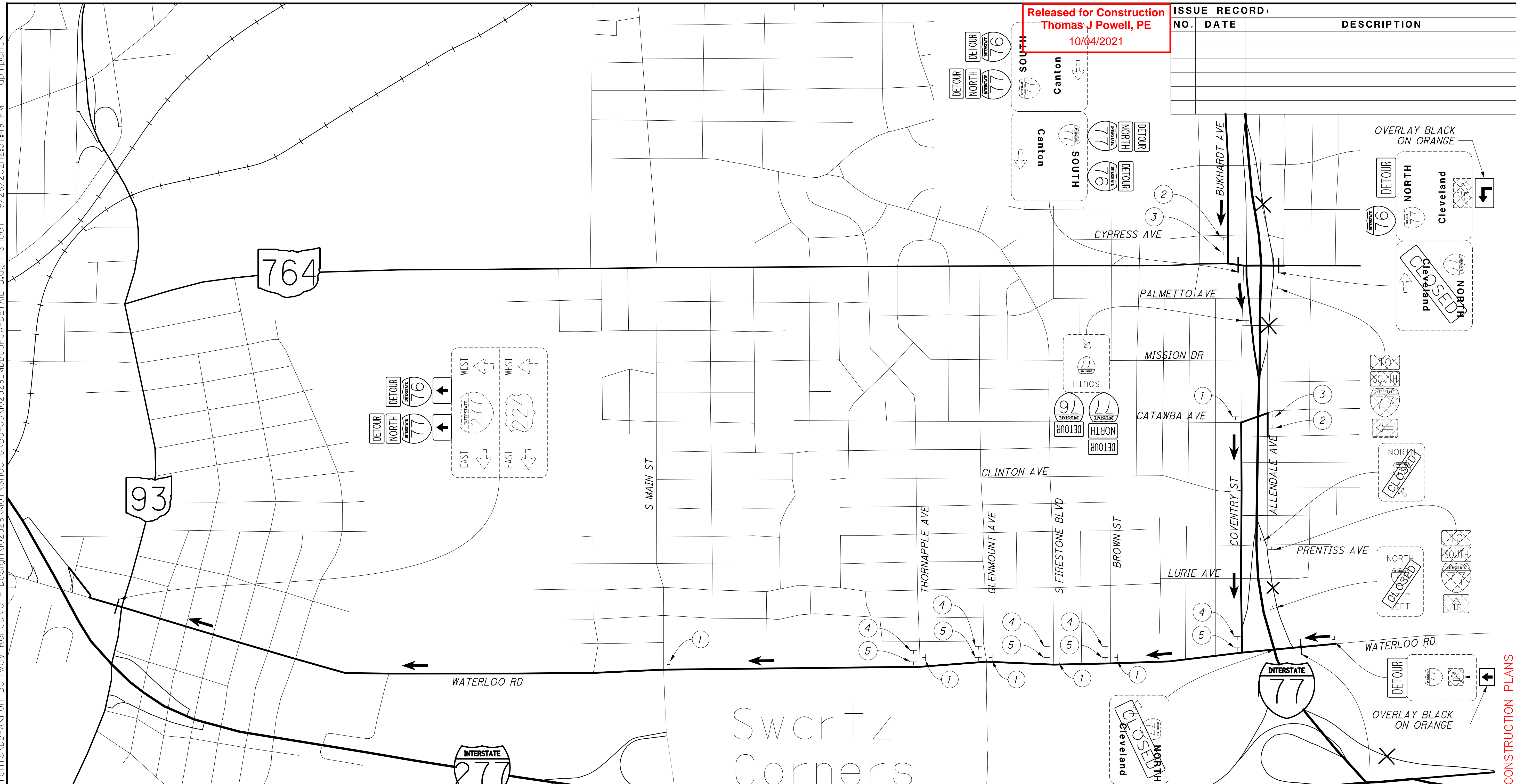

DETOUR KEY SIGNS

MI-1-30-3	MI-4-30-3	MI-1-30-2	MI-1-30-2
MI-5-30-2	M3-1-30	M3-3-30	M4-5-30
	M3-2-30	M3-4-30	M4-8-30

NOTE:
 ALL ROUTE SHIELDS ON OVERHEAD SIGNS
 SHALL BE 36" x 36" MINIMUM.

NOTES:

1. FOR LEGEND SEE SHEET 19

LEGEND	
	- DETOUR ROUTE
	- RAMP (ROAD) CLOSED

1		2	
3		4	
5			

DETAIL B DETOUR (PHASES 3A & 3B)
DETOUR MAP

2021-09-29 - BU 05 - RELEASED FOR CONSTRUCTION PLANS

SUM-76/77/8-
8.24/9.74/0.00

Released for Construction
 Thomas J Powell, PE
 10/04/2021

ISSUE RECORD:		
NO.	DATE	DESCRIPTION

CALCULATED
 BER
 CHECKED
 AVP

0 300 600
 HORIZONTAL
 SCALE IN FEET

LEGEND

➔ - DETOUR ROUTE
 ✕ - RAMP CLOSED

DETAIL C

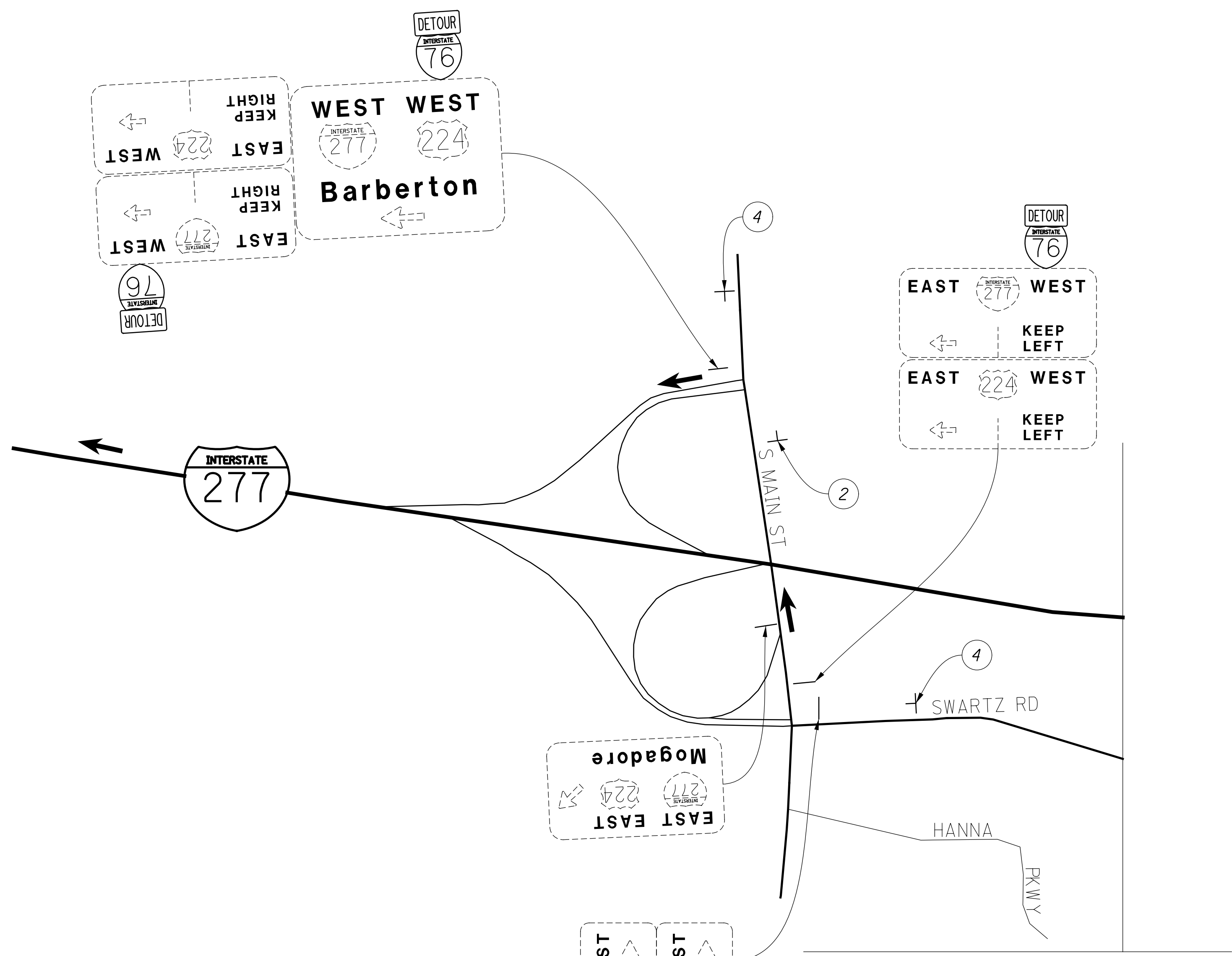

DETAIL D

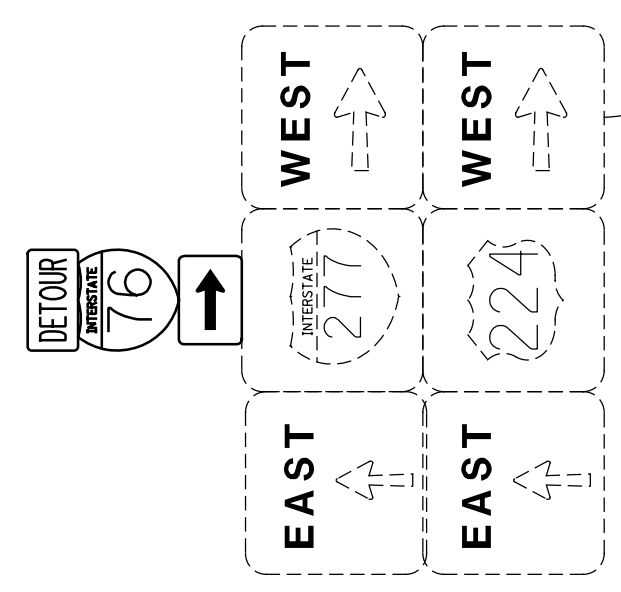
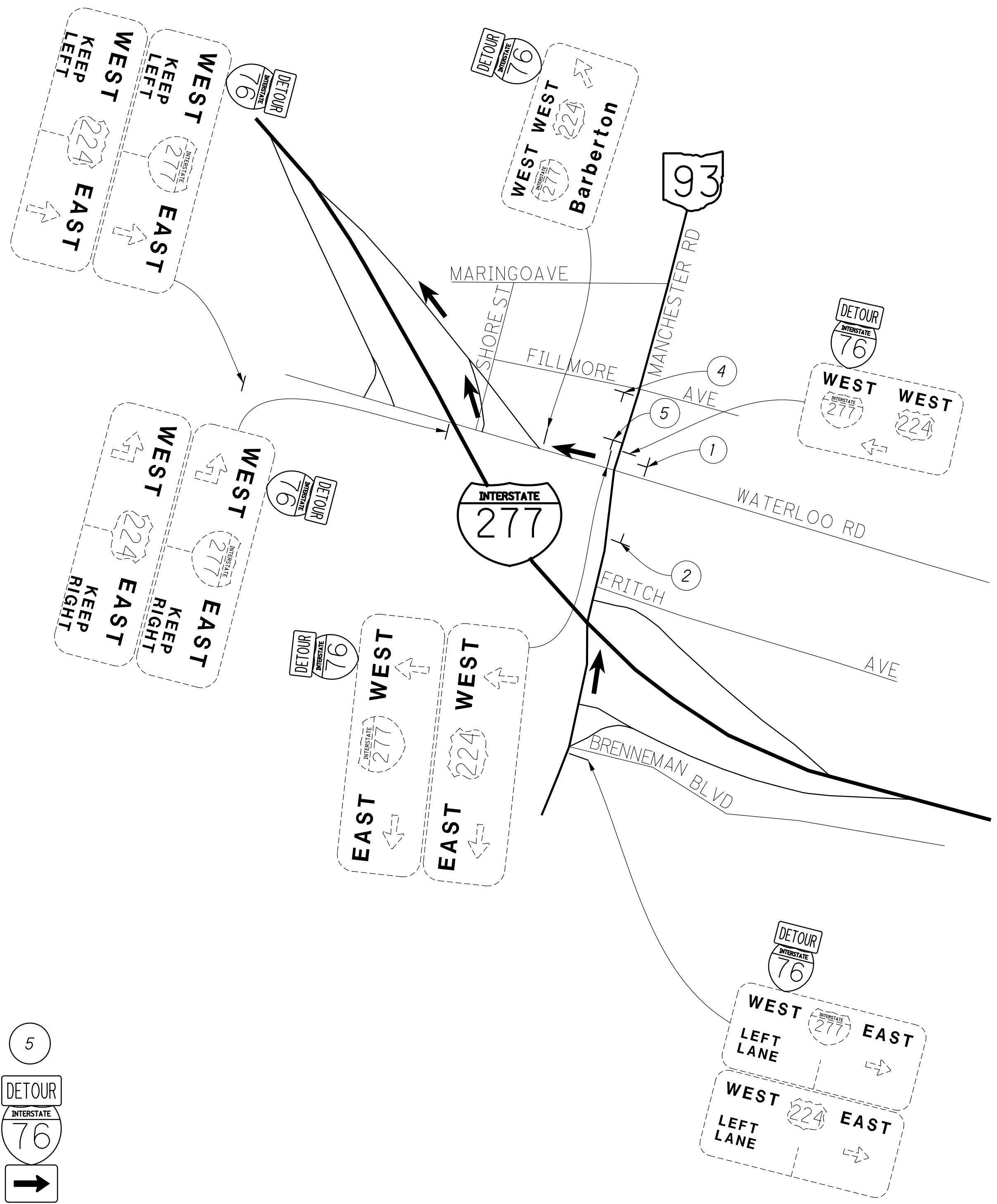

- 1

 M4-8-30
 M3-2-30
 M1-1-30-2
 M6-3-30
- 2

 M4-8-30
 M3-2-30
 M1-1-30-2
 M5-1-30
- 3

 M4-8-30
 M3-2-30
 M1-1-30-2
 M6-1-30
- 4

 M4-8-30
 M3-2-30
 M1-1-30-2
 M5-1-30
- 5

 M4-8-30
 M3-2-30
 M1-1-30-2
 M6-1-30

NOTES:
 1. FOR LEGEND SEE SHEET 19

ISSUE RECORD:		
NO.	DATE	DESCRIPTION

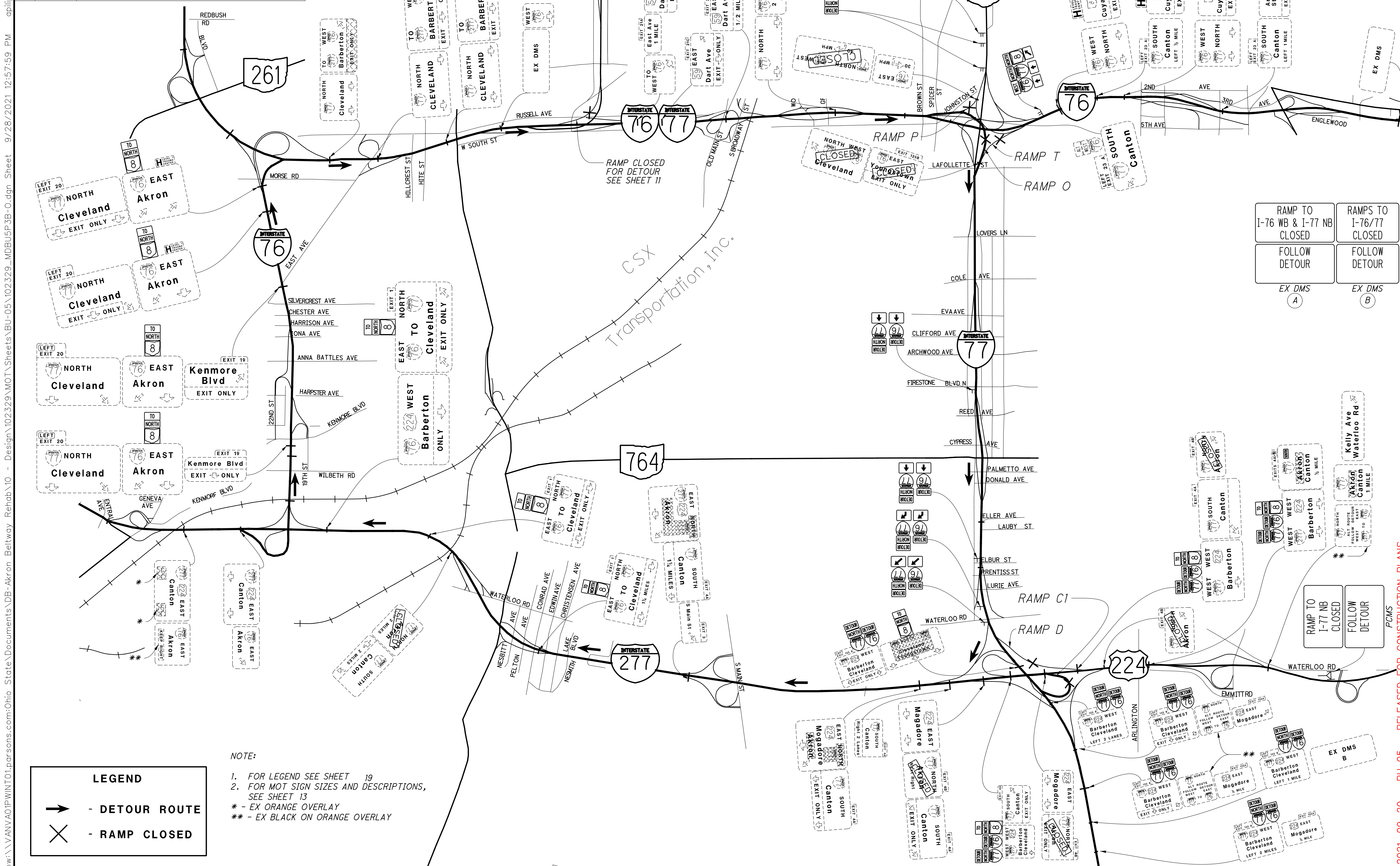

Released for Construction
 Thomas J. Powell
 10/04/2021

CSX
 Transportation, Inc.

RAMP CLOSED FOR DETOUR
 SEE SHEET 11

RAMP TO I-76 WB & I-77 NB CLOSED	RAMPS TO I-76/77 CLOSED
FOLLOW DETOUR	FOLLOW DETOUR
EX DMS A	EX DMS B

- NOTE:
- FOR LEGEND SEE SHEET 19
 - FOR MOT SIGN SIZES AND DESCRIPTIONS, SEE SHEET 13
- * - EX ORANGE OVERLAY
 - ** - EX BLACK ON ORANGE OVERLAY

LEGEND

- DETOUR ROUTE
- RAMP CLOSED



**RAMP C1, D, O, P, T CLOSURE (PHASE 3B)
 DETOUR MAP**

2021-09-29 - BU 05 - RELEASED FOR CONSTRUCTION PLANS

**SUM-76 / 77 / 8-
 8.24 / 9.74 / 0.00**

p:\VANVA01P\WINT01.parsons.com:Ohio State\Documents\Beltway Rehab\10 - Design\102329\MOT\Sheets\BU-05\102329_MBU5P3B-0.dgn Sheet 9/28/2021 12:57:59 PM aplipchuk

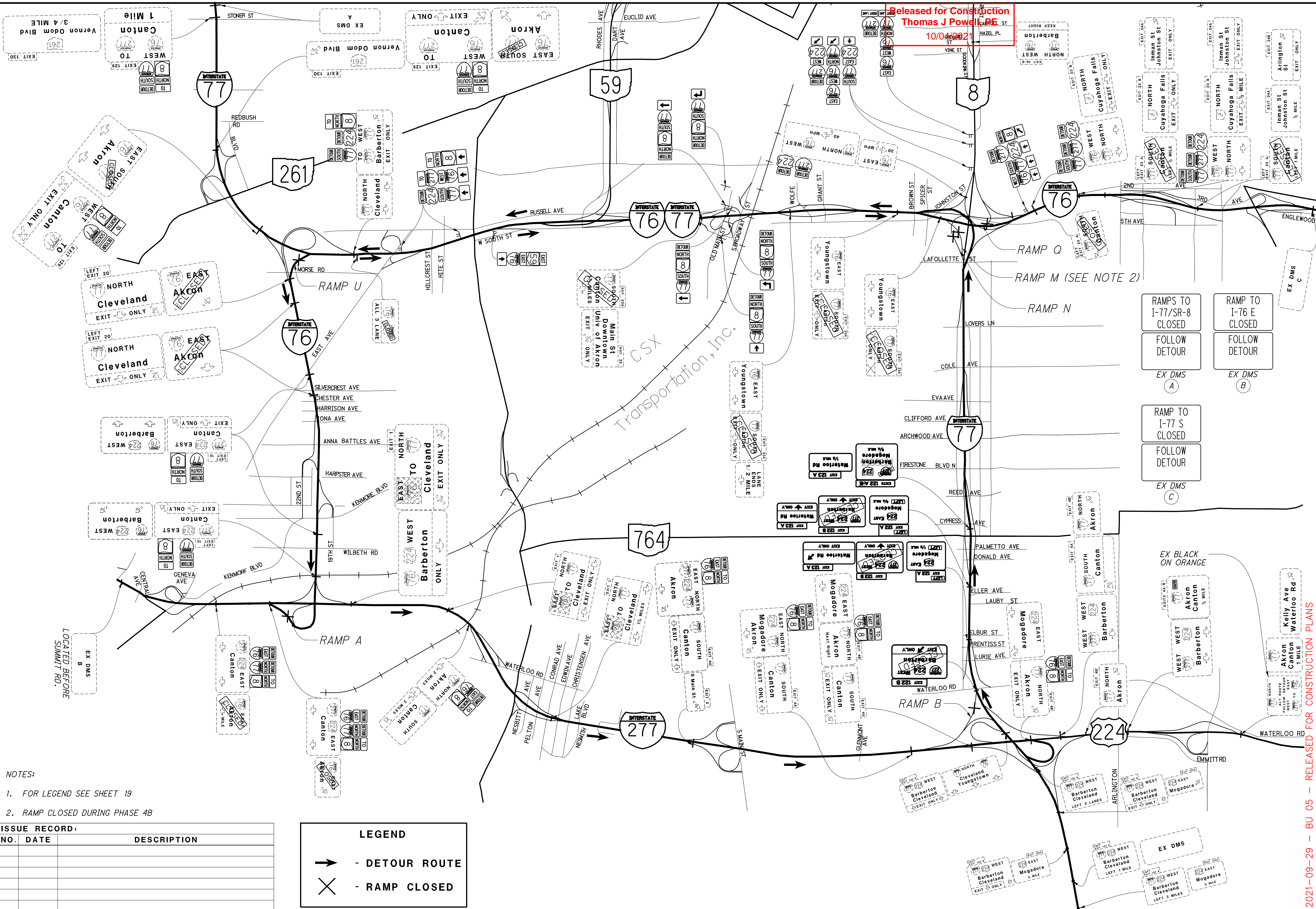

- NOTES:
1. FOR LEGEND SEE SHEET 19
 2. RAMP CLOSED DURING PHASE 4B

ISSUE RECORD:

NO.	DATE	DESCRIPTION

LEGEND

- DETOUR ROUTE
- RAMP CLOSED

RAMPS TO I-77/SR-8 CLOSED
FOLLOW DETOUR
EX DMS (A)

RAMP TO I-76 E CLOSED
FOLLOW DETOUR
EX DMS (B)

RAMP TO I-77 S CLOSED
FOLLOW DETOUR
EX DMS (C)

pw:\VANVAOPWINTO\parsons.com\Ohio State\Documents\DB-Akron Beltway Rehab\10 - Design\02329\M0T\Sheets\BU-05\02329_MDBU5P4A-21.dgn Sheet 9/28/2021 12:58:08 PM aplilpchnuk

MEDINA COUNTY

LEGEND

- ➔ - DETOUR ROUTE
- ✕ - RAMP CLOSED

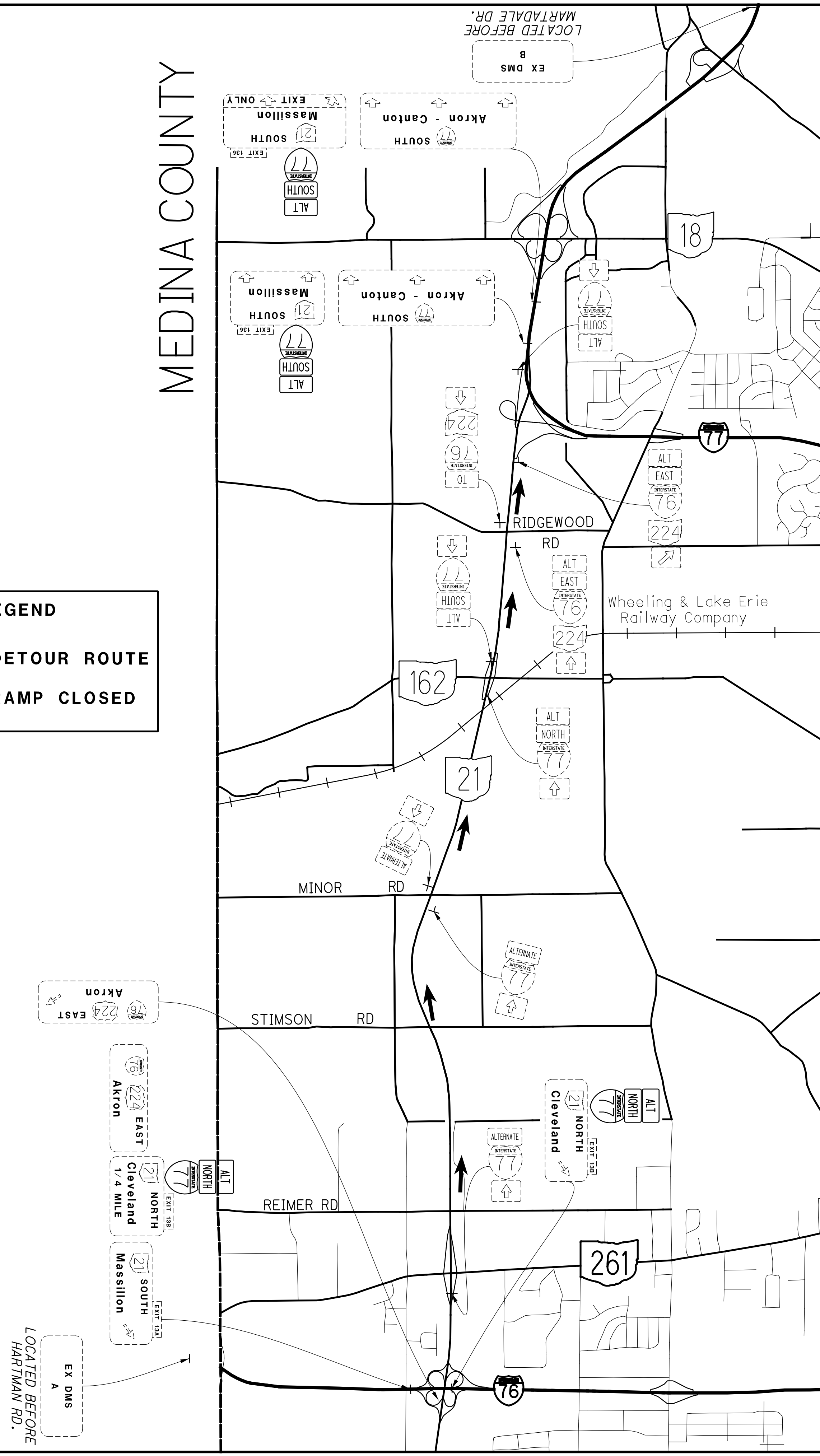

Released for Construction
Thomas J Powell, PE
10/04/2021

ISSUE RECORD:

NO.	DATE	DESCRIPTION

SCALE IN FEET

HORIZONTAL SCALE IN FEET

VERTICAL SCALE IN FEET

4000

2000

1000

0

CALCULATED BY: AVP

CHECKED BY: AVP

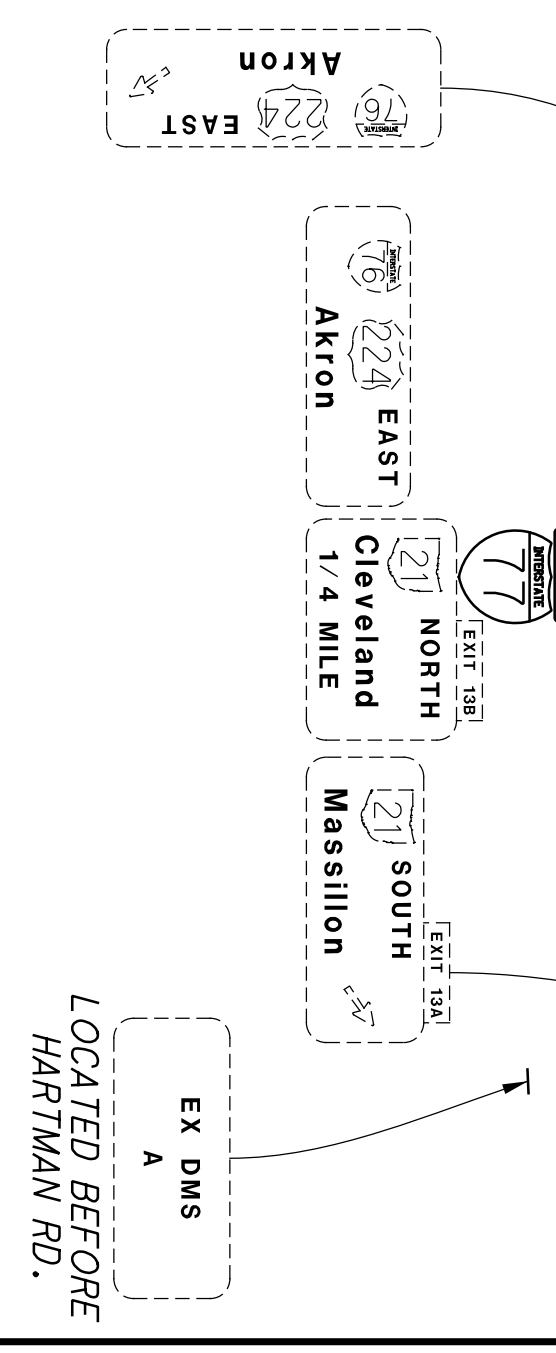

ALT I-77 N	ALT I-77 S
USE SR-21 N	USE SR-21 S
EX DMS (A)	EX DMS (B)

NOTE:
1. FOR LEGEND SEE SHEET 19

2021-09-29 - BU 05 - RELEASED FOR CONSTRUCTION PLANS

IR 77 NB ALTERNATE ROUTE (PHASES 4A, 5A, 5B) DETOUR MAP

SUM-76 / 77 / 8 - 8.24 / 9.74 / 0.00

Released for Construction
 Thomas J Powell
 10/04/2021

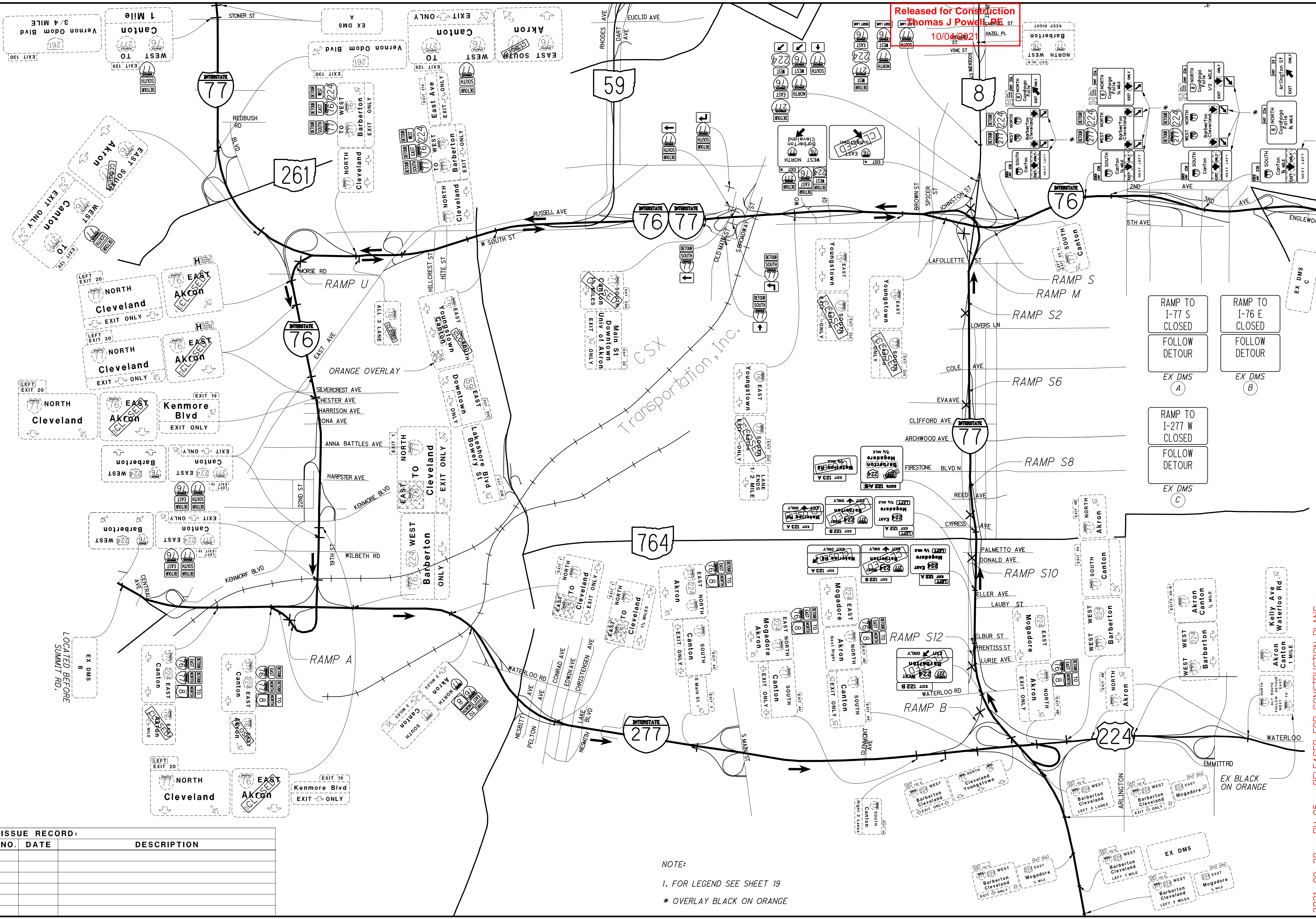

ISSUE RECORD:

NO.	DATE	DESCRIPTION

NOTE:
 1. FOR LEGEND SEE SHEET 19
 * OVERLAY BLACK ON ORANGE

2021-09-29 - BU 05 - RELEASED FOR CONSTRUCTION PLANS

RAMP A, B, M, S, U CLOSURE (PHASES 5A, 5B)

SUM-76 / 77 / 8 - 8.24 / 9.74 / 0.00

DETOUR MAP

18
105

CALCULATED BER CHECKED AVP

0 1000 2000
 HORIZONTAL SCALE IN FEET

pw:\VANVA01P\WINT01\parsons.com:Ohio State\Documents\Beltway Rehab\10 - Design\102329\MOT\Sheets\BU-05\102329_MPBUS104.dgn Sheet 9/28/2021 12:58:21 PM apilipchuk

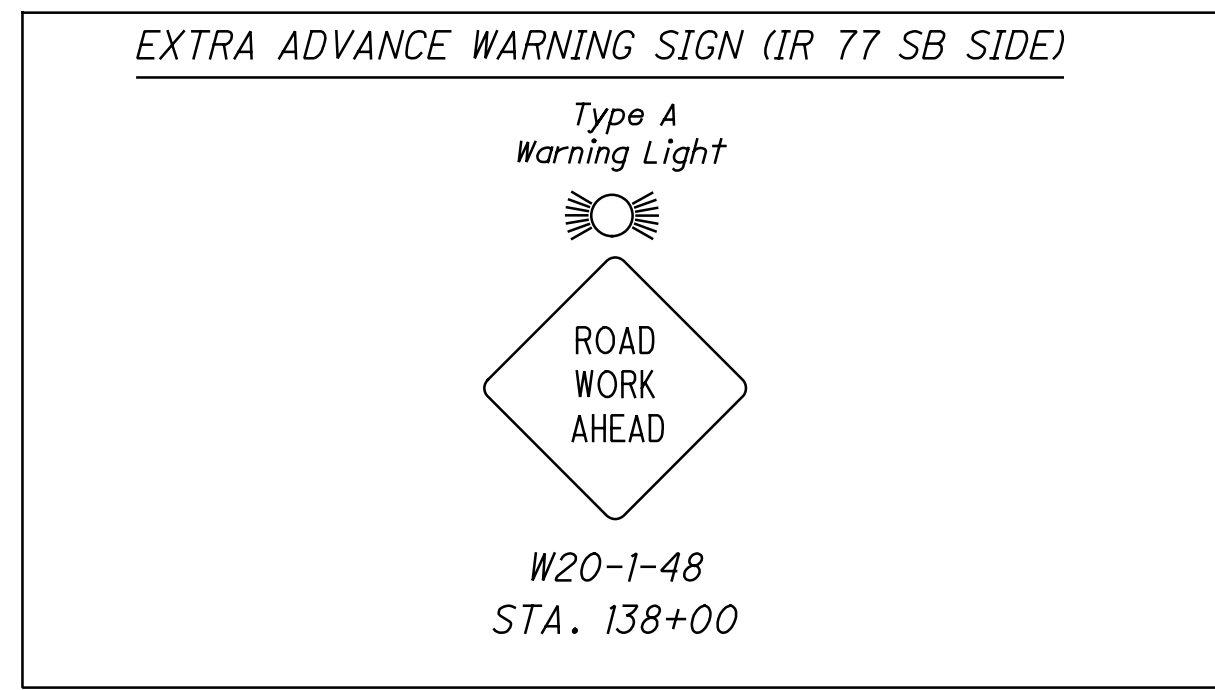

Released for Construction
 Thomas J Powell, PE
 10/04/2021

ISSUE RECORD:		
NO.	DATE	DESCRIPTION

- NOTES:
1. ALL STATIONING TAKEN FROM \varnothing IR 76/IR 77 UNLESS OTHERWISE NOTED
 2. FOR DRUM SPACING SEE MT-95.40, TABLE II
 3. FOR PB FLARE RATE SEE MT-95.40, TABLE II

0 50 100
 HORIZONTAL SCALE IN FEET
 CALCULATED VJ
 CHECKED AVP

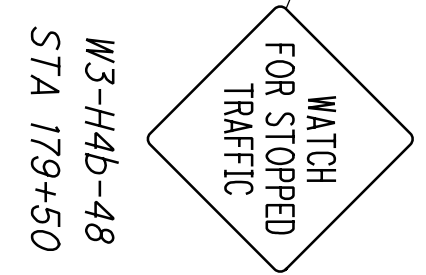
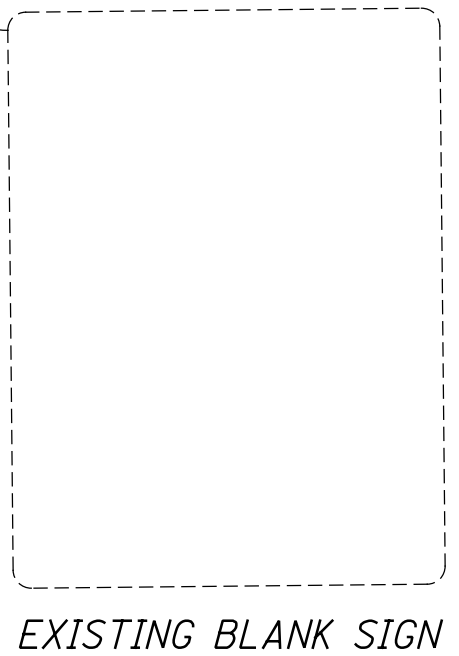
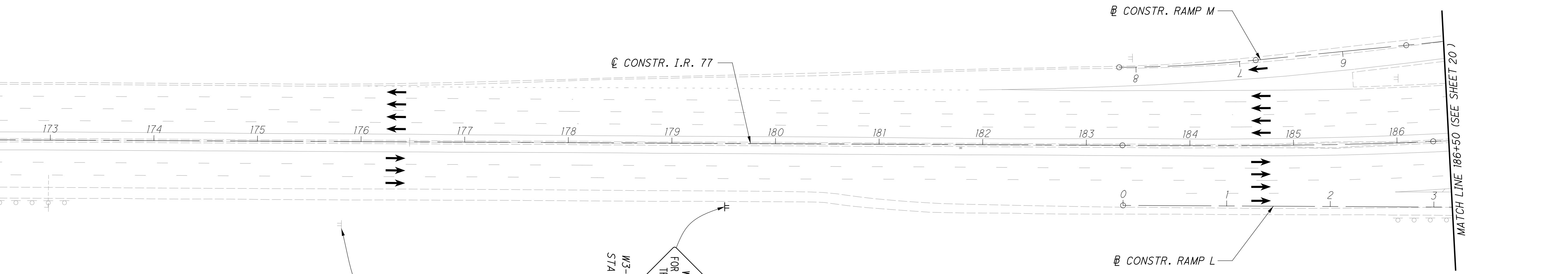

LEGEND

- | | | | | | |
|--|--|--|-----------------------------|--|---|
| | IMPACT ATTENUATOR | | PROPOSED WORK ZONE SIGN | | ITEM 614 - WORK ZONE EDGE LINE, WHITE |
| | TYPE 3 BARRICADE | | EXISTING SIGNS | | ITEM 614 - WORK ZONE LANE LINE |
| | PORTABLE CHANGEABLE MESSAGE SIGN | | EXISTING COVERED SIGNS | | ITEM 614 - WORK ZONE EDGE LINE, YELLOW |
| | "Y" CONNECTOR | | EXISTING SIGN TO BE REMOVED | | ITEM 614 - WORK ZONE CHANNELIZING LINE |
| | PORTABLE BARRIER (PB), 32" | | | | ITEM 614 - WORK ZONE DOTTED LINE |
| | PORTABLE BARRIER (PB), 50", APP | | | | ITEM 614 - WORK ZONE TRANSVERSE LINE |
| | DIRECTION OF TRAFFIC (NOT PVMT MARKINGS) | | | | ITEM 614 - SPECIAL - WORK ZONE GUARDRAIL |
| | MOT DRUM | | | | ITEM 611 - TEMPORARY DRAINAGE |
| | CONSTRUCTION UNDER THIS PHASE | | | | ITEM 614 - WORK ZONE IMPACT ATTENUATOR |
| | CONSTRUCTION UNDER PREVIOUS PHASE(S) | | | | ITEM 615 - TEMPORARY PAVEMENT FOR MAINTAINING TRAFFIC |
| | TEMPORARY CONSTRUCTION UNDER THIS PHASE | | | | ITEM 622 - PORTABLE BARRIER |
| | TEMPORARY CONSTRUCTION UNDER PREVIOUS PHASE(S) | | | | ITEM 622 - PORTABLE BARRIER, "Y" CONNECTOR |

2021-09-29 - BU 05 - RELEASED FOR CONSTRUCTION PLANS

MOT IR 77 PHASE 3A - STEPS 1 & 2
STA 174+00 TO STA 186+50

SUM-76 / 77 / 8-
8.24 / 9.74 / 0.00

pw:\VANV\A01PWINT01\parsons.com\Ohio State\Documents\B-Akron Beltway Rehab\10 - Design\102329\MOT\Sheets\BU-05\102329_MPBUS105.dgn Sheet 9/29/2021 10:25:13 AM apilipchuk

Released for Construction
 Thomas J Powell, PE
 10/04/2021

ISSUE RECORD:		
NO.	DATE	DESCRIPTION

- NOTES:
- FOR LEGEND, SEE SHEET 19
 - ALL STATIONING TAKEN FROM \emptyset CONSTRUCTION IR 77 UNLESS OTHERWISE NOTED
 - FOR DRUM SPACING SEE MT-95.40, TABLE II
 - FOR PB FLARE RATE SEE MT-95.40, TABLE II

CALCULATED
VJ
CHECKED
AVP

HORIZONTAL
SCALE IN FEET

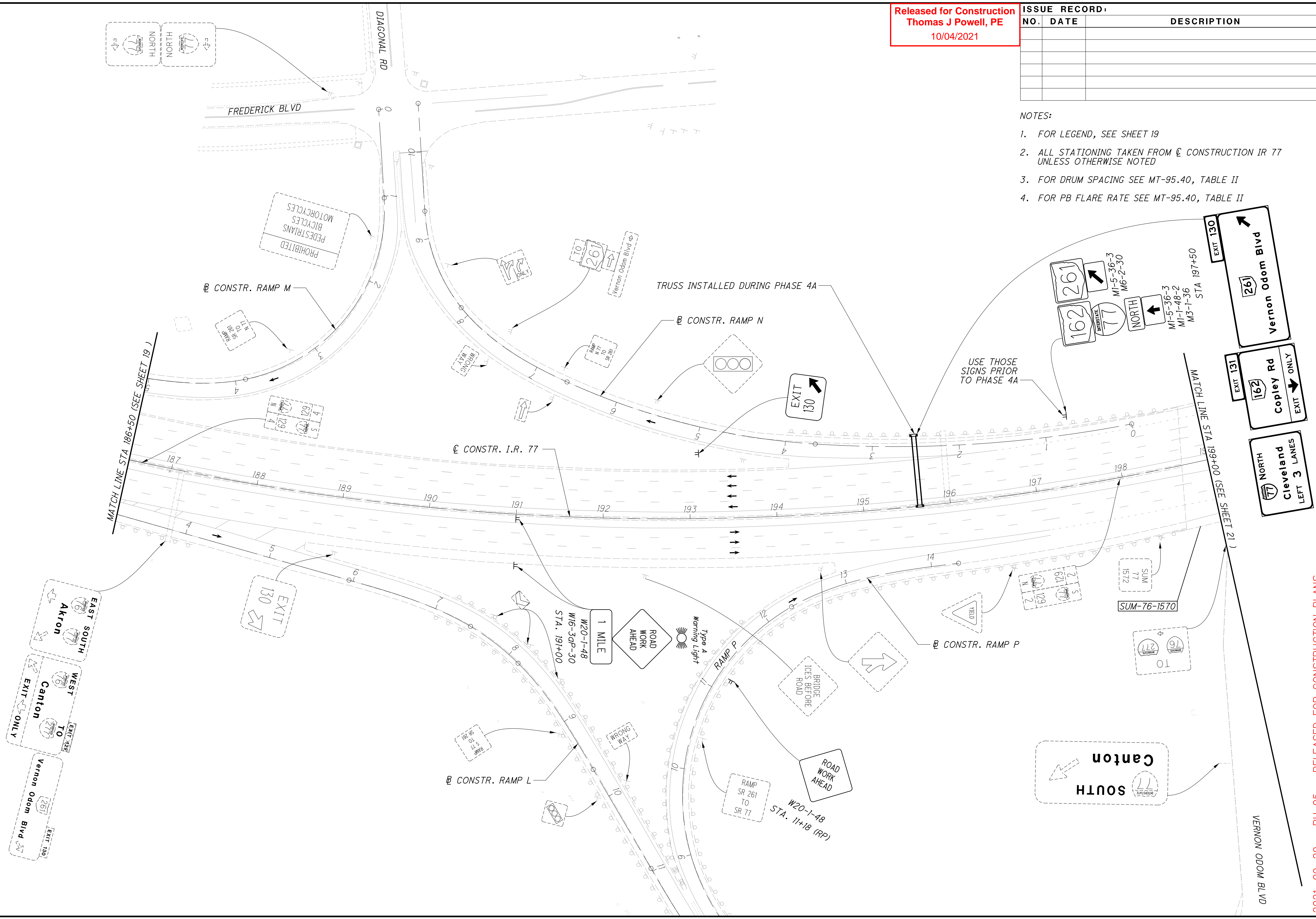

201-09-29 - BU 05 - RELEASED FOR CONSTRUCTION PLANS
 MOT IR 77 PHASE 3A - STEPS 1 & 2
 SUM-76 / 77 / 8 -
 8.24 / 9.74 / 0.00

pw:\VANVA01PWINT01.parsons.com:Ohio_State\Documents\DB-Akron Beltway Rehab\10 - Design\102329\MOT\Sheets\BU-05\102329_MPBUS106.dgn_Sheet_9/28/2021 12:58:36 PM aplipchuk

Released for Construction
 Thomas J Powell, PE
 10/04/2021

ISSUE RECORD:		
NO.	DATE	DESCRIPTION

- NOTES:
- FOR LEGEND, SEE SHEET 19
 - ALL STATIONING TAKEN FROM \varnothing CONSTRUCTION IR 77 UNLESS OTHERWISE NOTED
 - FOR DRUM SPACING SEE MT-95.40, TABLE II
 - FOR PB FLARE RATE SEE MT-95.40, TABLE II

CALCULATED	VJ
CHECKED	AVP

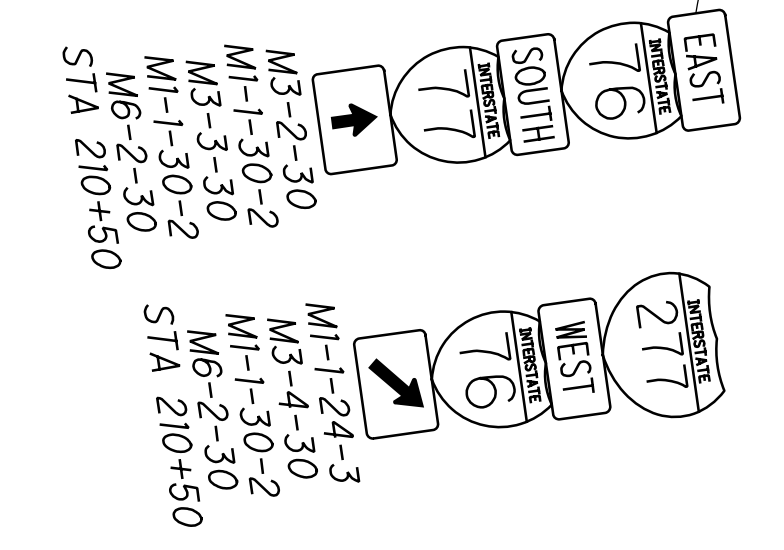
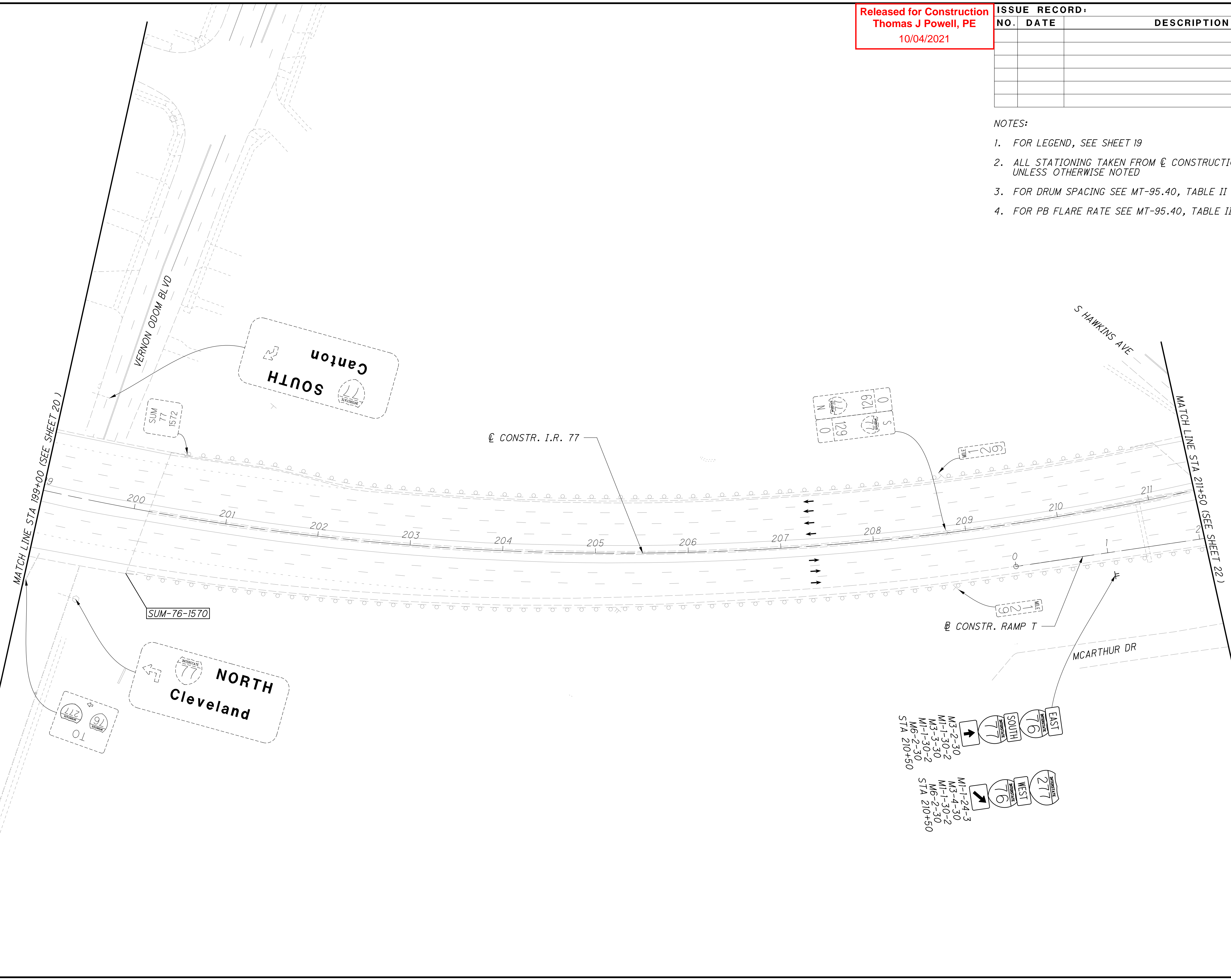

2021-09-29 - BU 05 - RELEASED FOR CONSTRUCTION PLANS

IR 77 PHASE 3A - STEPS 1 & 2
STA 199+00 TO STA 211+50

SUM-76 / 77 8-
8.24 / 9.74 / 0.00

pw:\VANVA01PWINT01.parsons.com:Ohio State Documents\DB-Akron Beltway Rehab\10 - Design\102329\MOT\Sheets\BU-05\102329_MPB05107.dgn Sheet 9/28/2021 12:58:42 PM apljpcuk

Released for Construction
 Thomas J Powell, PE
 10/04/2021

ISSUE RECORD:		
NO.	DATE	DESCRIPTION

- NOTES:
- FOR LEGEND, SEE SHEET 19
 - ALL STATIONING TAKEN FROM @ CONSTRUCTION IR 77 UNLESS OTHERWISE NOTED
 - FOR DRUM SPACING SEE MT-95.40, TABLE II
 - FOR PB FLARE RATE SEE MT-95.40, TABLE II

CALCULATED VJ
 CHECKED AVP

0 50 100
 25
 HORIZONTAL SCALE IN FEET

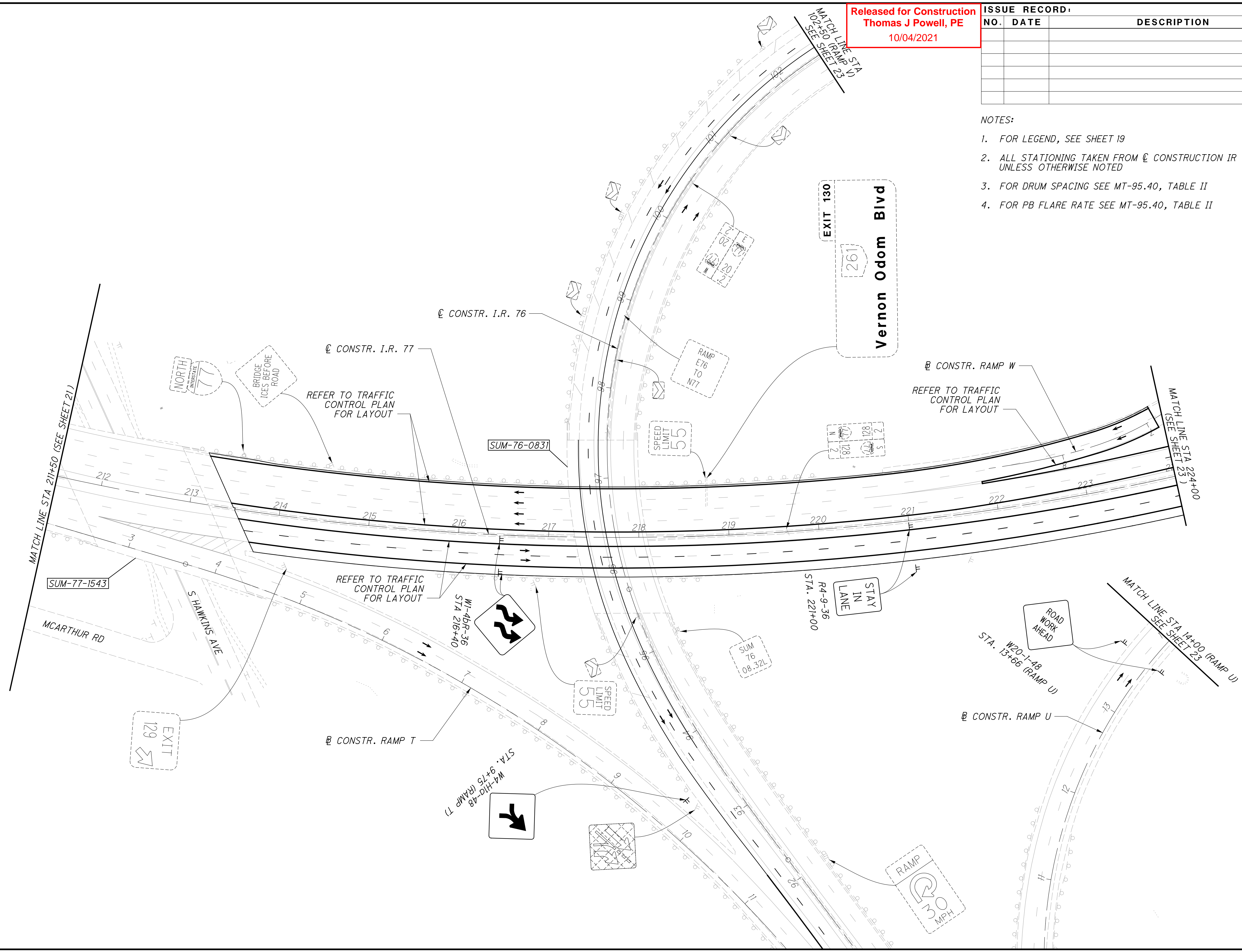

2021-09-29 - BU 05 - RELEASED FOR CONSTRUCTION PLANS

MOT IR 76 / IR 77 PHASE 3A - STEPS 1 & 2
 STA 211+50 TO STA 224+00

SUM-76 / 77 8-
 8.24 / 9.74 / 0.00

pw:\VANVA01PWINT01.parsons.com:Ohio State\Documents\B-Akron Beltway Rehab\10 - Design\102329\MOT\Sheets\BU-05\102329_MPB05108.dgn Sheet 9/28/2021 12:58:48 PM aplipchuk

Released for Construction
 Thomas J Powell, PE
 10/04/2021

ISSUE RECORD:		
NO.	DATE	DESCRIPTION

- NOTES:
- FOR LEGEND, SEE SHEET 19
 - ALL STATIONING TAKEN FROM \varnothing CONSTRUCTION IR 76/IR 77 UNLESS OTHERWISE NOTED
 - FOR DRUM SPACING SEE MT-95.40, TABLE II
 - FOR PB FLARE RATE SEE MT-95.40, TABLE II

CALCULATED VJ
 CHECKED AVP

0 25 50 100
 HORIZONTAL SCALE IN FEET

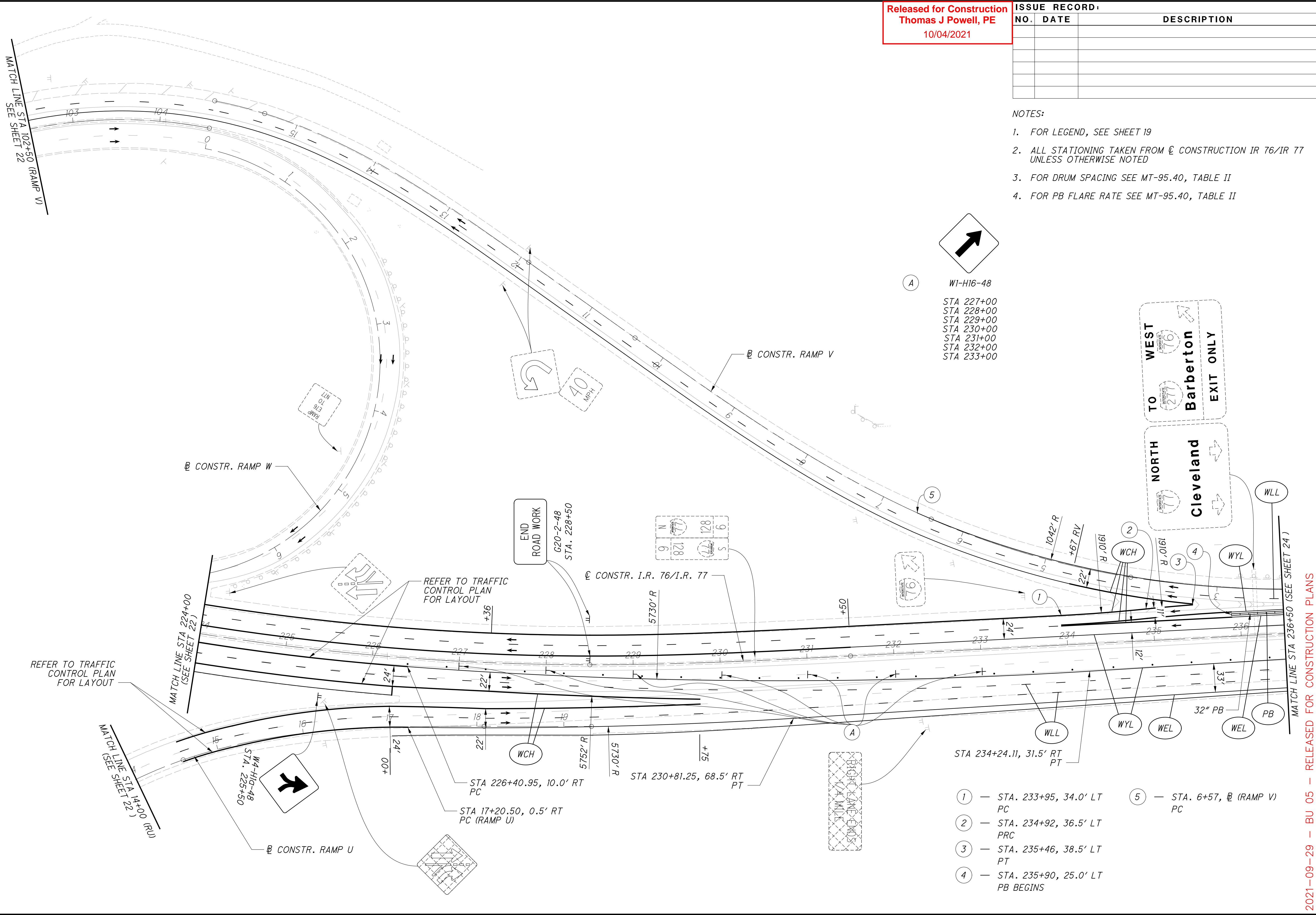

(A) W1-H16-48
 STA 227+00
 STA 228+00
 STA 229+00
 STA 230+00
 STA 231+00
 STA 232+00
 STA 233+00

- (1) — STA. 233+95, 34.0' LT PC
- (2) — STA. 234+92, 36.5' LT PRC
- (3) — STA. 235+46, 38.5' LT PT
- (4) — STA. 235+90, 25.0' LT PB BEGINS
- (5) — STA. 6+57, \varnothing (RAMP V) PC

2021-09-29 - BU 05 - RELEASED FOR CONSTRUCTION PLANS

MOT IR 76 / IR 77 PHASE 3A - STEPS 1 & 2

SUM-76 / 77 / 8 - STA 224+00 TO STA 236+50

8.24 / 9.74 / 0.00

23 / 105

Released for Construction
 Thomas J Powell, PE
 10/04/2021

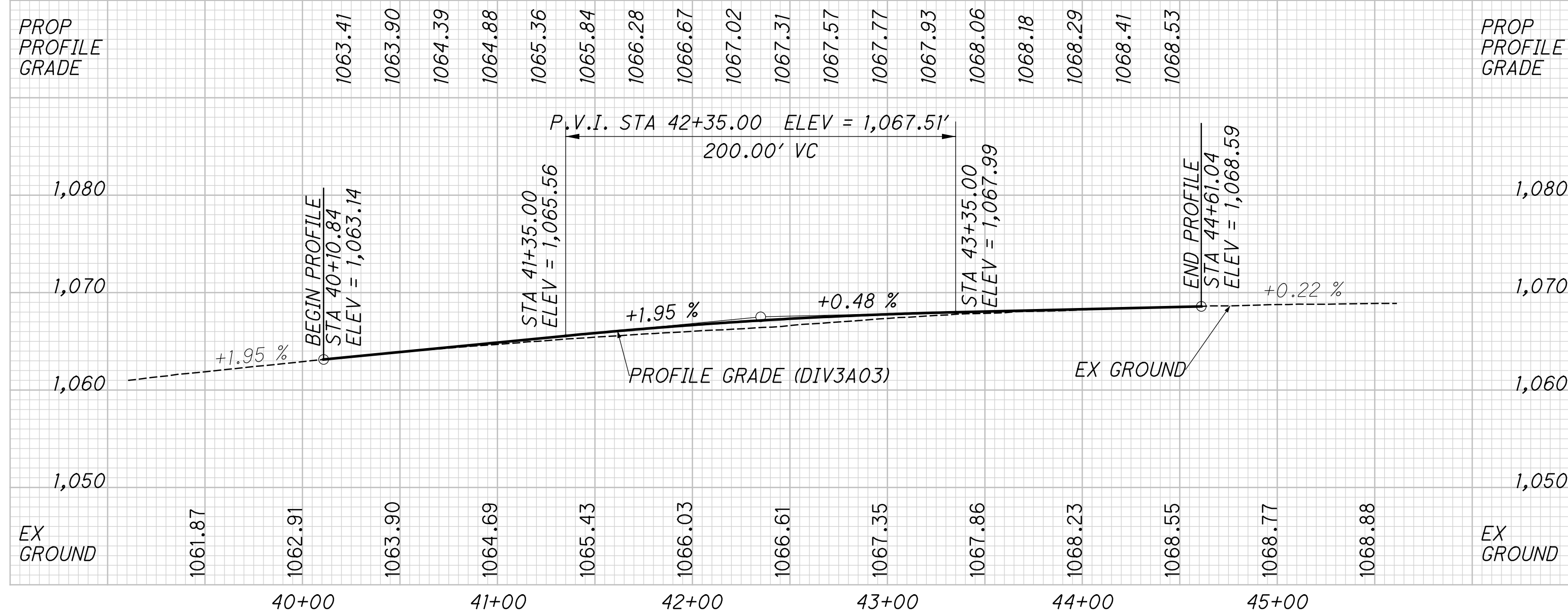

CURVE DATA DIV3A03
 P.I. Sta. 41+23.52
 $\Delta = 6^\circ 45' 11''$ (RT)
 $D_c = 3^\circ 00' 00''$
 $R = 1,909.86'$
 $T = 112.68'$
 $L = 225.10'$
 $E = 3.32'$
 $C = 224.97'$
 $C.B. = S 86^\circ 59' 21'' E$

CURVE DATA DIV3A03
 P.I. Sta. 43+48.62
 $\Delta = 6^\circ 45' 11''$ (LT)
 $D_c = 3^\circ 00' 00''$
 $R = 1,909.86'$
 $T = 112.68'$
 $L = 225.10'$
 $E = 3.32'$
 $C = 224.97'$
 $C.B. = S 86^\circ 59' 21'' E$

- 1 — STA. 1+73, 2.0' RT (RAMP V) PT
- 2 — STA. 240+83, 7.0' LT PB BEGINS
- 3 — STA. 242+40, 38.0' LT LANE SHIFT BEGINS
- 4 — STA. 242+87, 32.5' LT LANE SHIFT ENDS LANE TAPER BEGINS
- 5 — STA. 243+87, 16.0' LT LANE TAPER ENDS LANE SHIFT BEGINS
- 6 — STA. 243+35, 15.5' LT LANE SHIFT ENDS
- 7 — STA. 243+90, 17.5' LT PB BEGINS
- 8 — STA. 244+09, 1.0' RT PB ENDS
- 9 — STA. 246+60, 16.5' RT LANE TAPER BEGINS
- 10 — STA. 246+97, 15.5' RT LANE TAPER ENDS

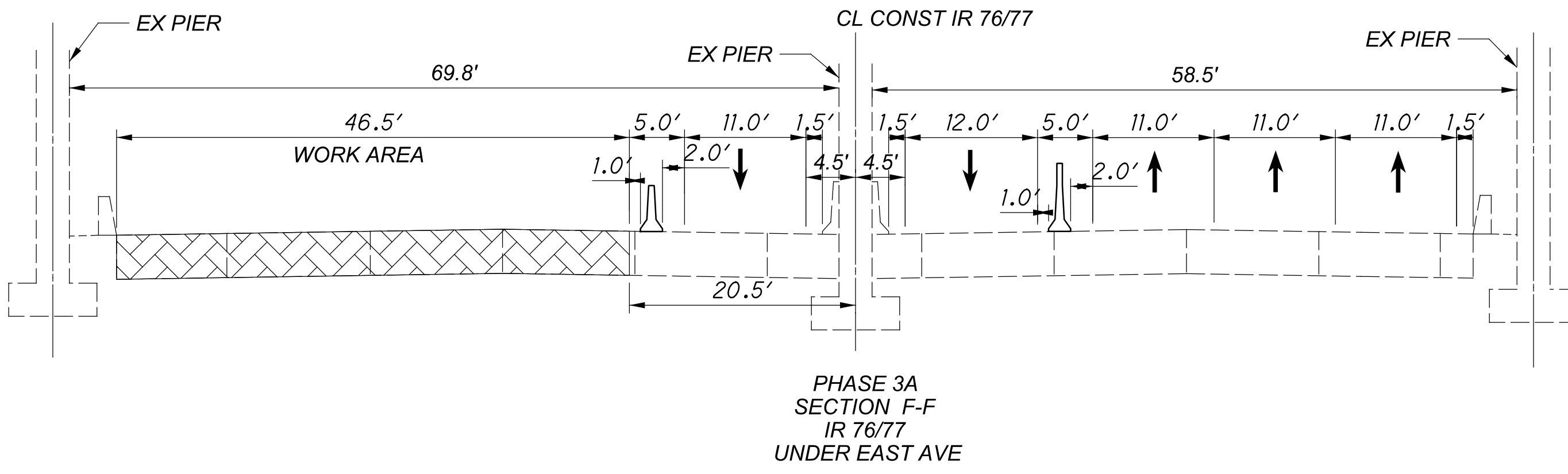

PHASE 3A
 SECTION F-F
 IR 76/77
 UNDER EAST AVE

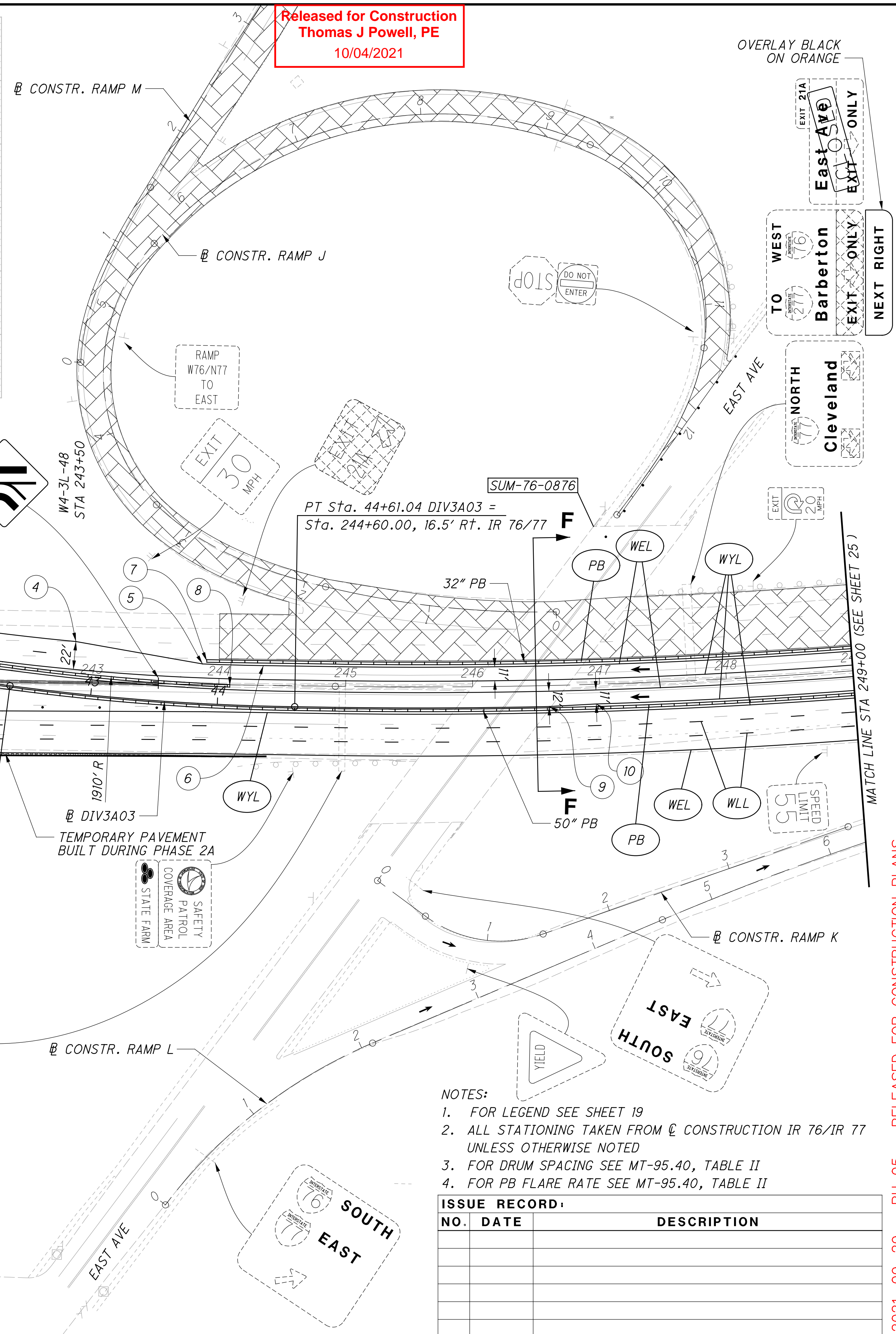

- NOTES:
- FOR LEGEND SEE SHEET 19
 - ALL STATIONING TAKEN FROM \varnothing CONSTRUCTION IR 76/IR 77 UNLESS OTHERWISE NOTED
 - FOR DRUM SPACING SEE MT-95.40, TABLE II
 - FOR PB FLARE RATE SEE MT-95.40, TABLE II

ISSUE RECORD:		
NO.	DATE	DESCRIPTION

p:\VANVA01P\WINT01\parsons.com:Ohio State\Documents\DB-Akron Beltway Rehab\10 - Design\102329\MOT\Sheets\BU-05\102329_MPB05110.dgn_Sheet 9/28/2021 12:59:00 PM apilipchuk

Released for Construction
 Thomas J Powell, PE
 10/04/2021

ISSUE RECORD:		
NO.	DATE	DESCRIPTION

25
 50
 100
 HORIZONTAL
 SCALE IN FEET

CALCULATED
 VJ
 CHECKED
 AVP

- NOTES:
- FOR LEGEND, SEE SHEET 19
 - ALL STATIONING TAKEN FROM \varnothing CONSTRUCTION IR 76/IR 77 UNLESS OTHERWISE NOTED
 - FOR DRUM SPACING SEE MT-95.40, TABLE II
 - FOR PB FLARE RATE SEE MT-95.40, TABLE II

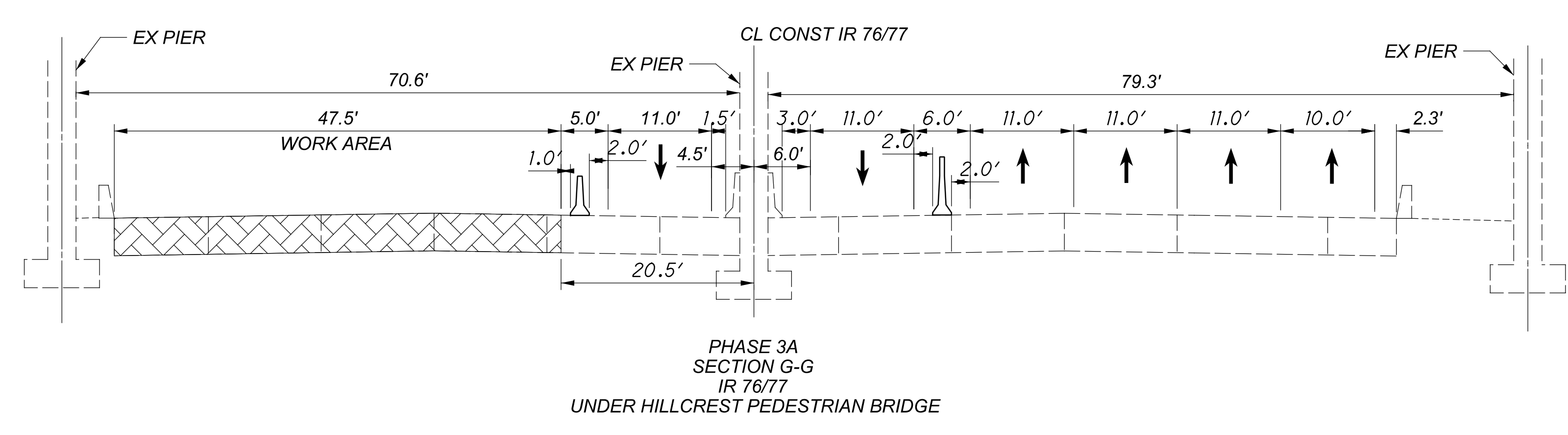
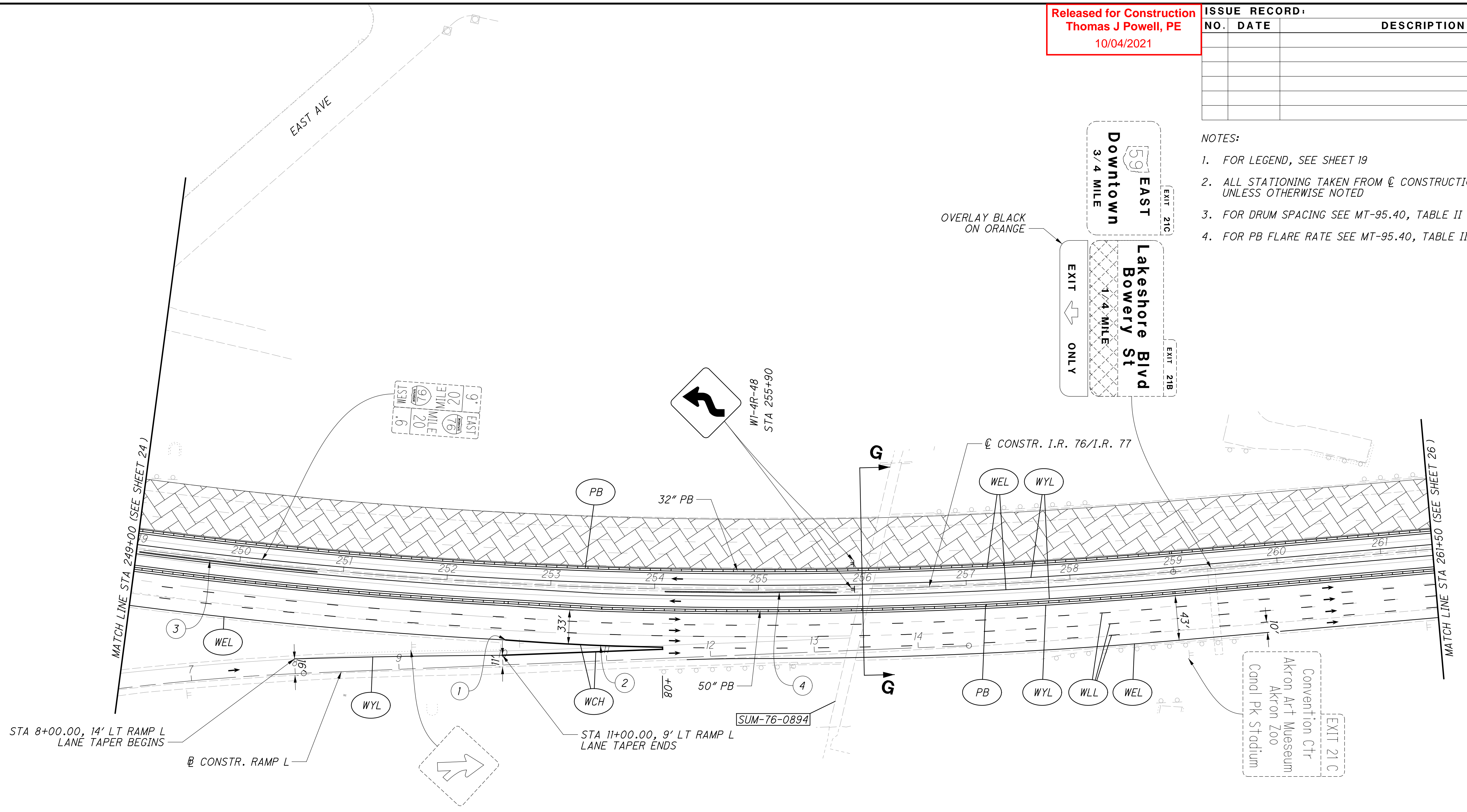

- ① — STA. 252+60, 54.5' RT LANE SHIFT BEGINS
- ② — STA. 253+50, 56.0' RT LANE SHIFT ENDS
- ③ — TROUGH, WIDTH - 12.0", DEPTH - 1.5", LENGTH 172' BEGIN STA. 249+03 END STA. 250+75
- ④ — TROUGH, WIDTH - 15.5", DEPTH - 1.5", LENGTH 165' BEGIN STA. 254+10 END STA. 255+75

2021-09-29 - BU 05 - RELEASED FOR CONSTRUCTION PLANS

MOT IR 76 / IR 77 PHASE 3A - STEPS 1 & 2
 STA 249+00 TO STA 261+50

SUM-76 / 77 / 8-
 8.24 / 9.74 / 0.00

d:\va\va01p\wintol\parsons.com\Ohio State\Documents\DB-Akron Beltway Rehab\10 - Design\02329\MOT\Sheets\BU-05\02329.MPB\BU5\I.dgn Sheet 9/28/2021 12:59:07 PM apilipchuk

Released for Construction
 Thomas J Powell, PE
 10/04/2021

ISSUE RECORD:		
NO.	DATE	DESCRIPTION

- NOTES:
- FOR LEGEND, SEE SHEET 19
 - ALL STATIONING TAKEN FROM \varnothing CONSTRUCTION IR 76/IR 77 UNLESS OTHERWISE NOTED
 - FOR DRUM SPACING SEE MT-95.40, TABLE II
 - FOR PB FLARE RATE SEE MT-95.40, TABLE II

CALCULATED
VJ
CHECKED
AVP

0 50 100
 HORIZONTAL
 SCALE IN FEET

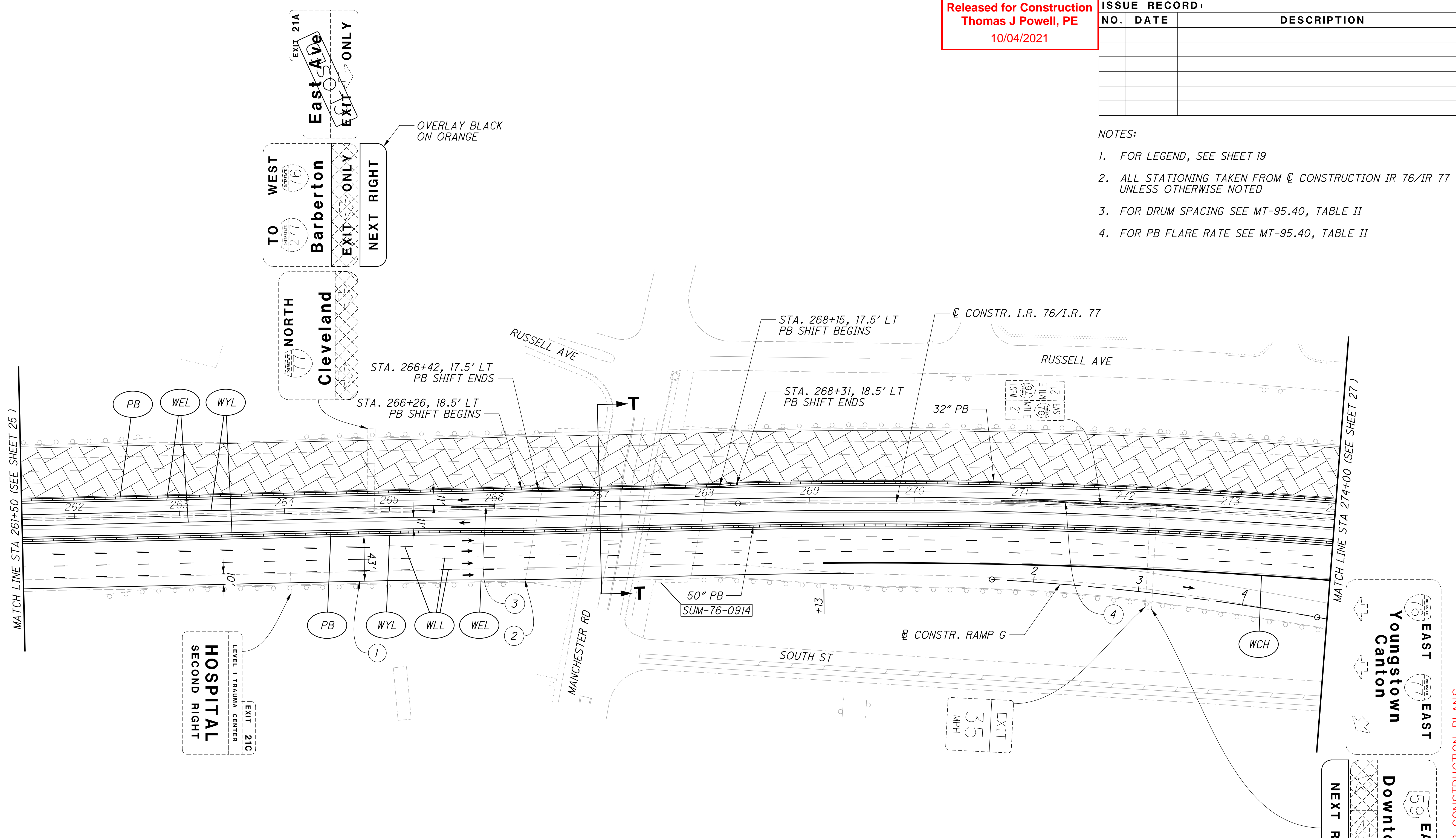

- ① — STA. 264+70, 66.0' RT LANE SHIFT BEGINS
- ② — STA. 264+27, 68.0' RT LANE SHIFT ENDS
- ③ — TROUGH, WIDTH - 4.0", DEPTH - 1.5", LENGTH 41'
BEGIN STA. 265+59
END STA. 266+00
- ④ — TROUGH, WIDTH - 18.0", DEPTH - 1.5", LENGTH 188'
BEGIN STA. 270+82
END STA. 272+70

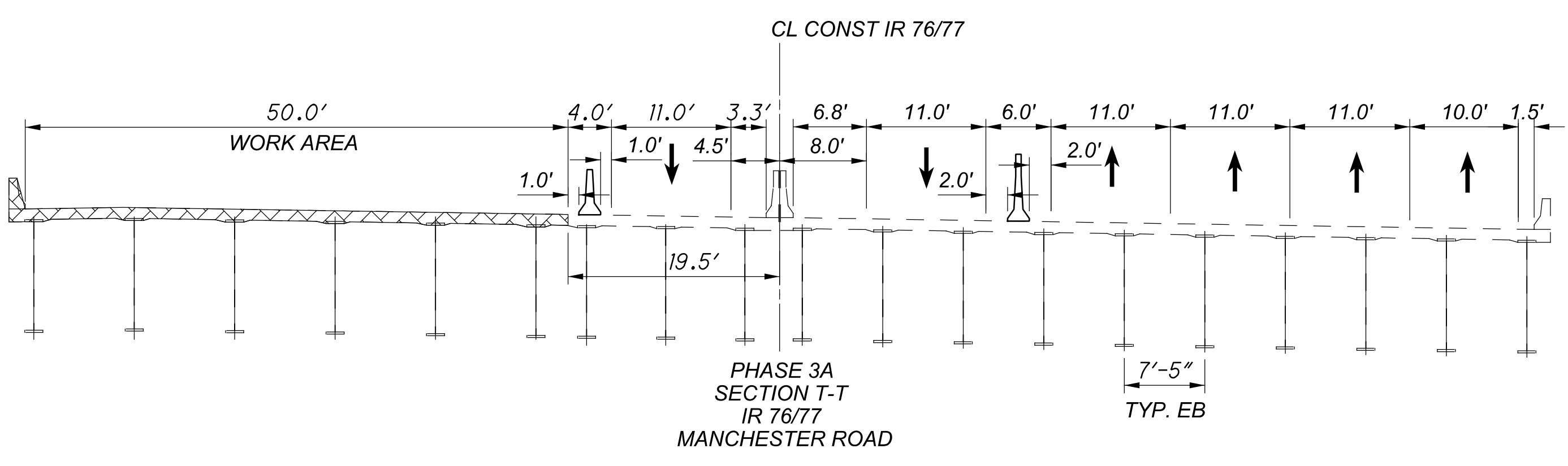

MOT IR 76 / IR 77 PHASE 3A - STEPS 1 & 2
 SUM-76/77/8-8.24/9.74/0.00
 2021-09-29 - BU 05 - RELEASED FOR CONSTRUCTION PLANS

D:\VANVAOP\WINTO\parsons.com\Ohio State\Documents\DB-Akron Beltway Rehab\10 - Design\02329\MOT\Sheets\BU-05\02329_MPBUI12.dgn Sheet 9/28/2021 12:59:13 PM apilpochuk

Released for Construction
 Thomas J Powell, PE
 10/04/2021

ISSUE RECORD:		
NO.	DATE	DESCRIPTION

CALCULATED VJ
 CHECKED AVP

- NOTES:
- FOR LEGEND, SEE SHEET 19
 - ALL STATIONING TAKEN FROM \varnothing CONSTRUCTION IR 76/IR 77 UNLESS OTHERWISE NOTED
 - FOR DRUM SPACING SEE MT-95.40, TABLE II
 - FOR PB FLARE RATE SEE MT-95.40, TABLE II

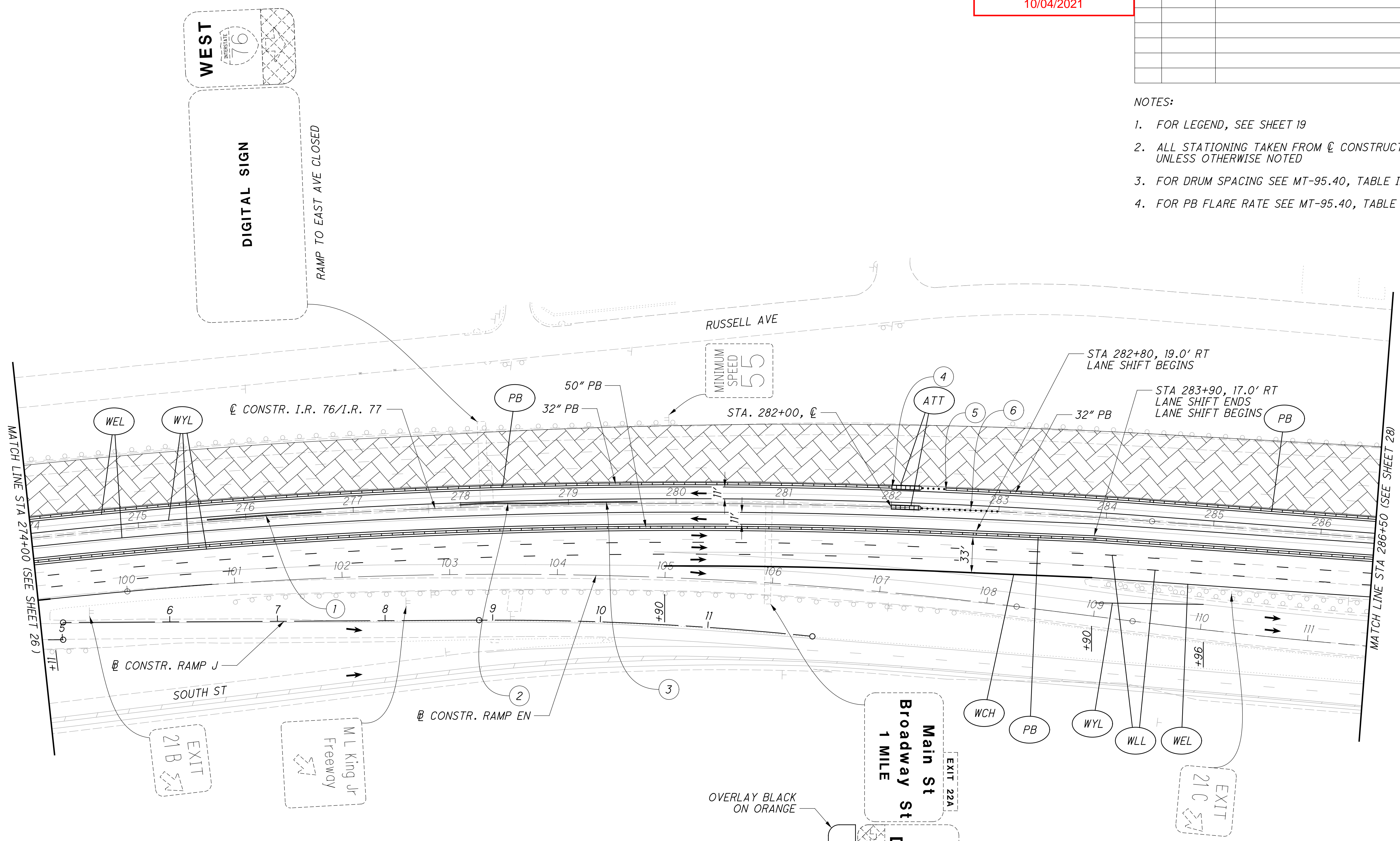

- | | |
|--|---|
| <p>① — TROUGH, WIDTH - 18.5", DEPTH - 1.5", LENGTH 106'
 BEGIN STA. 275+64
 END STA. 276+70</p> <p>② — TROUGH, WIDTH - 19.0", DEPTH - 1.5", LENGTH 81'
 BEGIN STA. 277+99
 END STA. 278+80</p> <p>③ — TROUGH, WIDTH - 7.0", DEPTH - 1.5", LENGTH 84'
 BEGIN STA. 279+64
 END STA. 278+80</p> | <p>④ — STA. 282+00, 18.5' LT
 PB ENDS</p> <p>⑤ — STA. 282+50, 18.5' LT
 PB BEGINS</p> <p>⑥ — REMOVE MEDIAN BARRIER
 BETWEEN STA. 282+00 AND 283+00
 PRIOR TO PHASE 3A</p> |
|--|---|

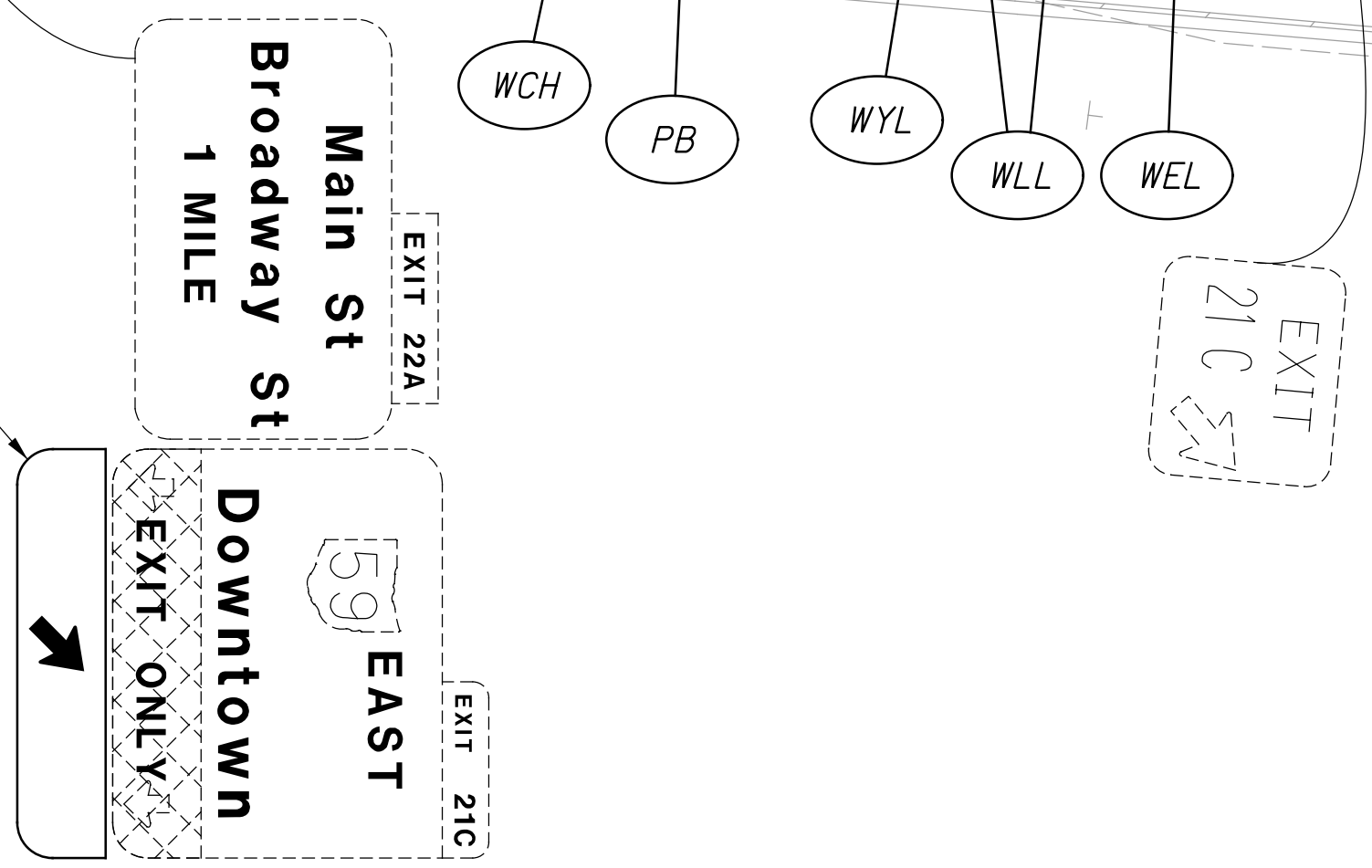

2021-09-29 - BU 05 - RELEASED FOR CONSTRUCTION PLANS

MOT IR 76 / IR 77 PHASE 3A - STEPS 1 & 2
 STA 274+00 TO STA 286+50

SUM-76/77/8-
 8.24/9.74/0.00

Released for Construction
 Thomas J Powell, PE
 10/04/2021

ISSUE RECORD:		
NO.	DATE	DESCRIPTION

- NOTES:
- FOR LEGEND, SEE SHEET 19
 - ALL STATIONING TAKEN FROM CL CONSTRUCTION IR 76/IR 77 UNLESS OTHERWISE NOTED
 - FOR DRUM SPACING SEE MT-95.40, TABLE II
 - FOR PB FLARE RATE SEE MT-95.40, TABLE II

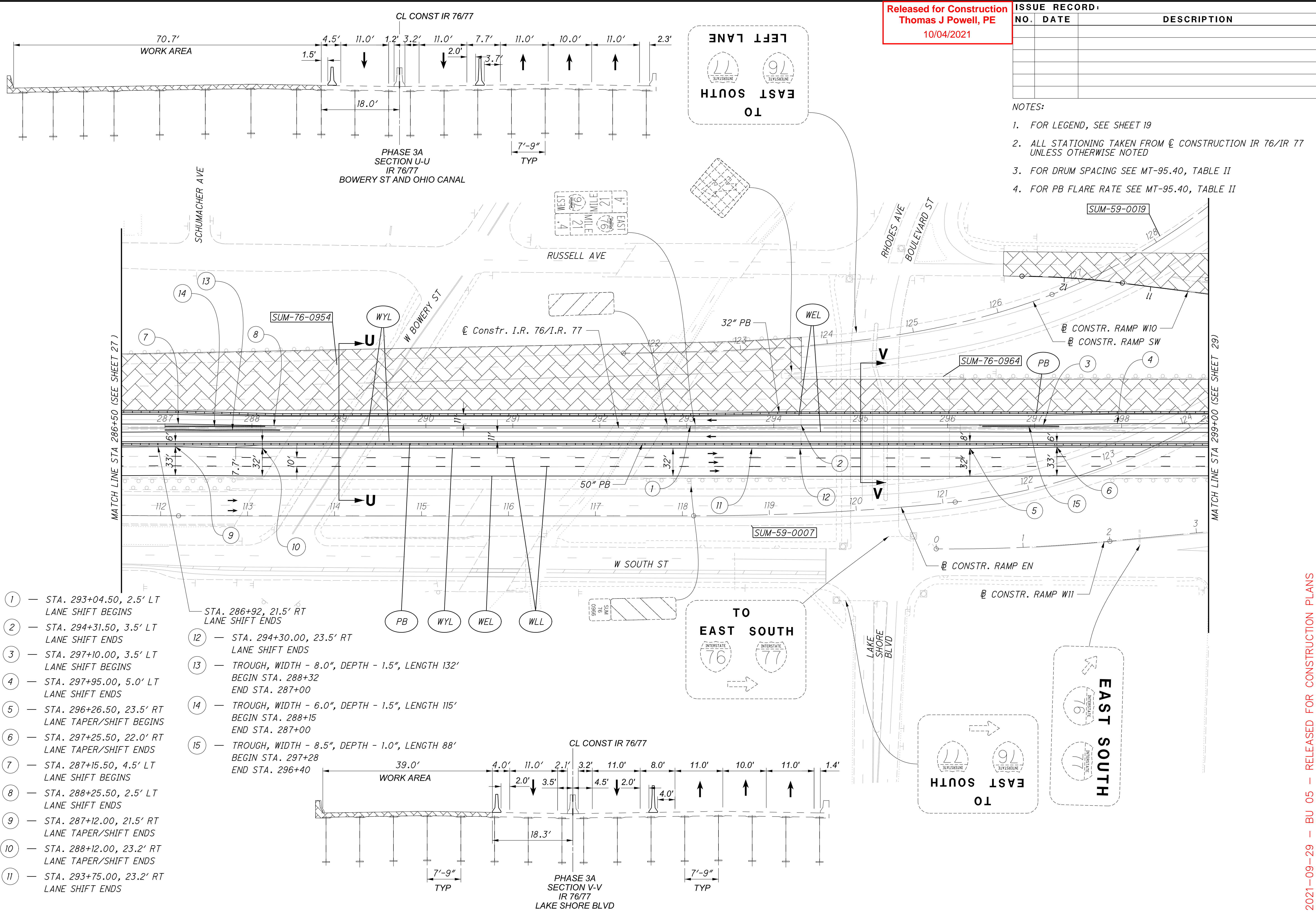

- 1 - STA. 293+04.50, 2.5' LT LANE SHIFT BEGINS
- 2 - STA. 294+31.50, 3.5' LT LANE SHIFT ENDS
- 3 - STA. 297+10.00, 3.5' LT LANE SHIFT BEGINS
- 4 - STA. 297+95.00, 5.0' LT LANE SHIFT ENDS
- 5 - STA. 296+26.50, 23.5' RT LANE TAPER/SHIFT BEGINS
- 6 - STA. 297+25.50, 22.0' RT LANE TAPER/SHIFT ENDS
- 7 - STA. 287+15.50, 4.5' LT LANE SHIFT BEGINS
- 8 - STA. 288+25.50, 2.5' LT LANE SHIFT ENDS
- 9 - STA. 287+12.00, 21.5' RT LANE TAPER/SHIFT ENDS
- 10 - STA. 288+12.00, 23.2' RT LANE TAPER/SHIFT ENDS
- 11 - STA. 293+75.00, 23.2' RT LANE SHIFT ENDS

- 12 - STA. 294+30.00, 23.5' RT LANE SHIFT ENDS
- 13 - TROUGH, WIDTH - 8.0", DEPTH - 1.5", LENGTH 132' BEGIN STA. 288+32 END STA. 287+00
- 14 - TROUGH, WIDTH - 6.0", DEPTH - 1.5", LENGTH 115' BEGIN STA. 288+15 END STA. 287+00
- 15 - TROUGH, WIDTH - 8.5", DEPTH - 1.0", LENGTH 88' BEGIN STA. 297+28 END STA. 296+40

2021-09-29 - BU 05 - RELEASED FOR CONSTRUCTION PLANS

MOT IR 76 / IR 77 PHASE 3A - STEP 1
 STA 286+50 TO STA 299+00
 SUM-76/77/8-8.24/9.74/0.00

pw:\VANVAOP\WINTO\parsons.com\Ohio State\Documents\Ohio State\Rehab\0 - Design\02329\MOT\Sheets\BU-05\02329.MPB\514.dgn Sheet 9/28/2021 12:59:24 PM apilipchuk

Released for Construction
 Thomas J Powell, PE
 10/04/2021

ISSUE RECORD:		
NO.	DATE	DESCRIPTION

- NOTES:
- FOR LEGEND, SEE SHEET 19
 - ALL STATIONING TAKEN FROM CL IR 76/IR 77 UNLESS OTHERWISE NOTED
 - FOR DRUM SPACING SEE MT-95.40, TABLE II
 - FOR PB FLARE RATE SEE MT-95.40, TABLE II

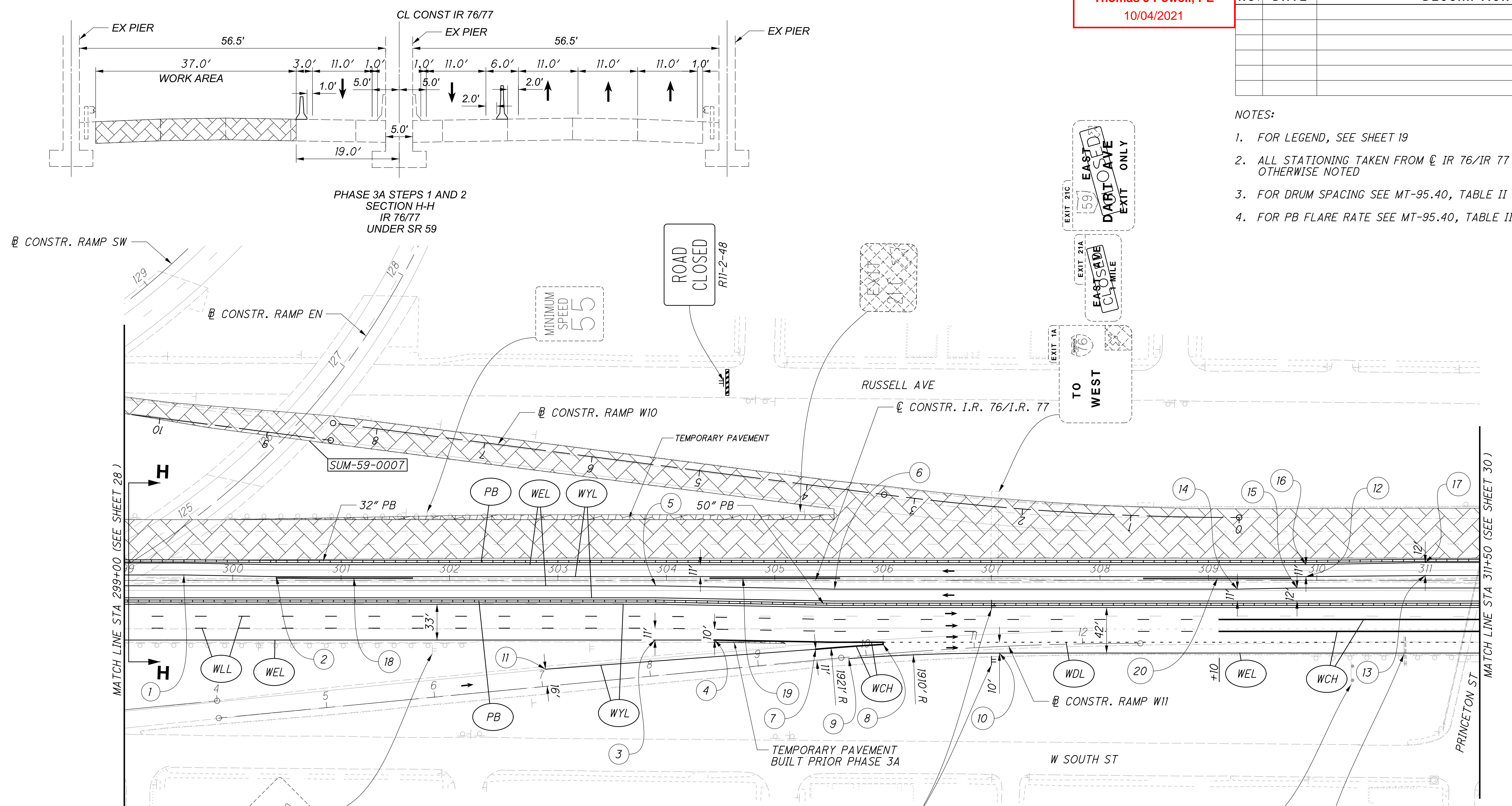
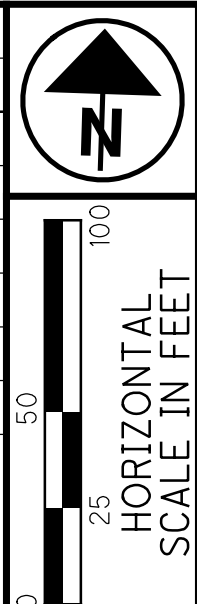

- | | | |
|--|---|---|
| <p>1 - STA 299+55, 5.0' LT LANE SHIFT BEGINS</p> <p>2 - STA 300+40, 3.5' LT LANE SHIFT ENDS</p> <p>3 - STA 303+90, 55.0' RT LANE SHIFT BEGINS</p> <p>4 - STA 304+45, 55.0' RT LANE TAPER ENDS</p> <p>5 - STA 303+90, 8.0' RT LANE SHIFT BEGINS</p> <p>6 - STA 305+55, 5.0' RT LANE SHIFT ENDS</p> <p>7 - STA 9+54, 10.0' LT (RAMP W11) LANE TAPER ENDS, PC</p> <p>8 - STA 10+16, 9.0' LT (RAMP W11) PT</p> | <p>9 - STA 9+77, 1.5' RT (RAMP W11) LANE TAPER BEGINS, PC</p> <p>10 - STA 11+23, 6.0' RT (RAMP W11) LANE TAPER ENDS, PT</p> <p>11 - STA 7+04, 16.0' LT (RAMP W11) LANE TAPER BEGINS</p> <p>12 - STA 309+90, 3.5' LT LANE SHIFT BEGINS</p> <p>13 - STA 311+00, 4.5' LT LANE SHIFT ENDS</p> <p>14 - STA 309+27, 8.0' RT LANE TAPER BEGINS</p> <p>15 - STA 309+82, 7.0' RT LANE TAPER ENDS</p> | <p>16 - STA 309+90, 14.5' LT LANE TAPER BEGINS (2' OUTSIDE SHOULDER)</p> <p>17 - STA 311+00, 16.5' LT LANE TAPER ENDS (1' OUTSIDE SHOULDER)</p> <p>18 - TROUGH, WIDTH - 9.5", DEPTH - 1.5", LENGTH 126' BEGIN STA. 301+66 END STA. 300+40</p> <p>19 - TROUGH, WIDTH - 8.5", DEPTH - 1.5", LENGTH 120' BEGIN STA. 305+60 END STA. 304+40</p> <p>20 - TROUGH, WIDTH - 7.5", DEPTH - 1.5", LENGTH 136' BEGIN STA. 309+76 END STA. 308+40</p> |
|--|---|---|

2021-09-29 - BU 05 - RELEASED FOR CONSTRUCTION PLANS

MOT IR 76 / IR 77 PHASE 3A - STEP 1
 STA 299+00 TO STA 311+50

SUM-76/77/8-
 8.24/9.74/0.00

CURVE DATA - DIV3A04

P.I. Sta. 13+38.59
 $\Delta = 8^\circ 52' 37''$ (LT)
 $D_c = 3^\circ 01' 08''$
 $R = 1,897.86'$
 $T = 147.31'$
 $L = 294.03'$
 $E = 5.71'$
 $C = 293.74'$
 $C.B. = N 83^\circ 41' 09'' E$

P.I. Sta. 16+34.49
 $\Delta = 8^\circ 52' 38''$ (RT)
 $D_c = 2^\circ 58' 53''$
 $R = 1,921.86'$
 $T = 149.18'$
 $L = 297.77'$
 $E = 5.78'$
 $C = 297.47'$
 $C.B. = N 83^\circ 41' 10'' E$

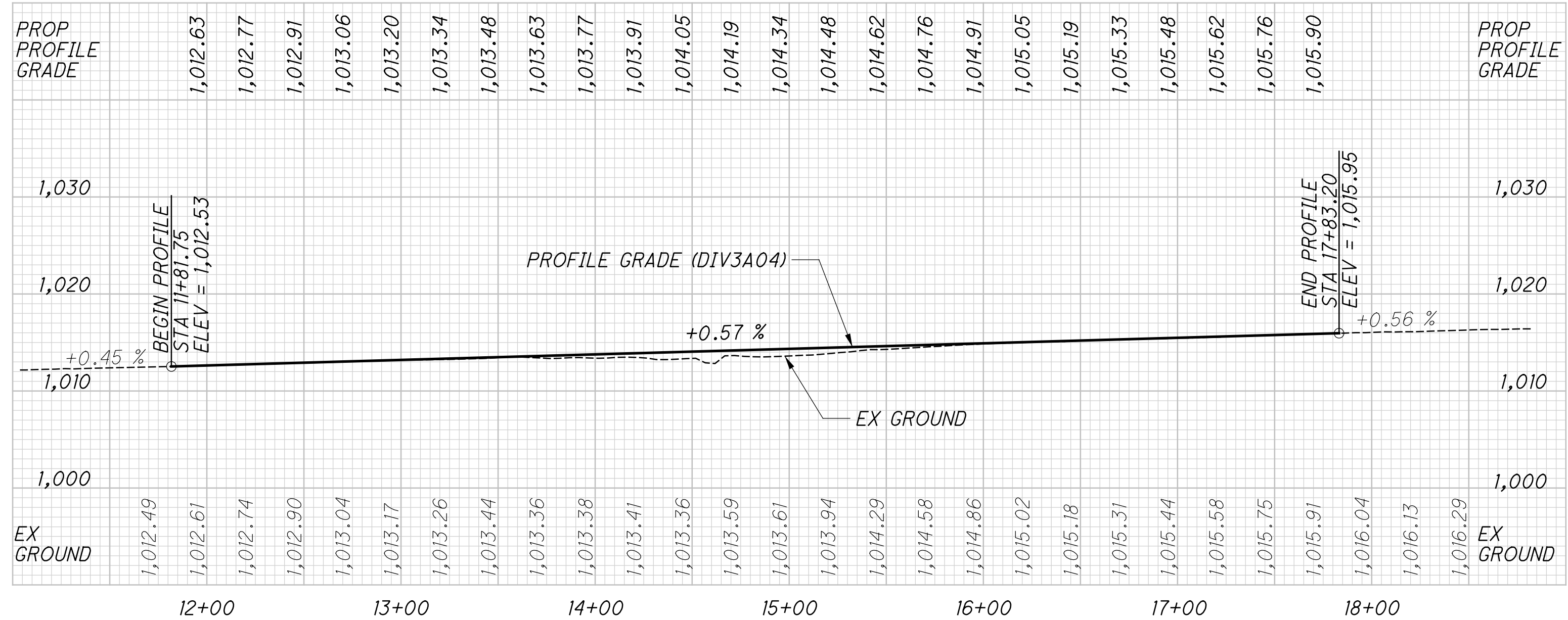
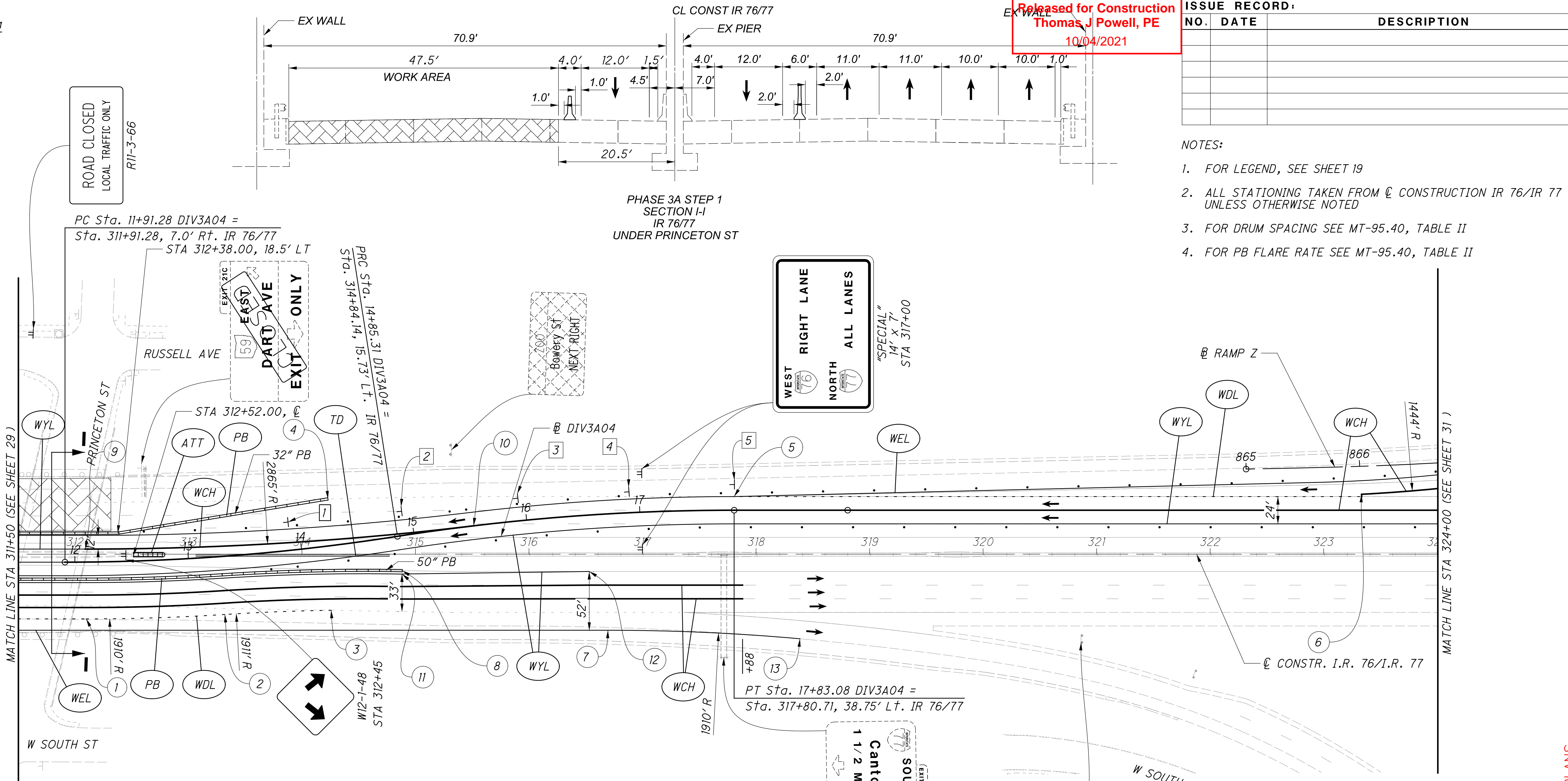

- 1 - STA 312+10, 57.0' RT PC
- 2 - STA 313+32, 53.0' RT PRC
- 3 - STA 314+26, 49.5' RT PT
- 4 - STA. 314+23, 48.0' LT PB ENDS
- 5 - STA. 317+81, 50.0' LT LANE TAPER BEGINS
- 6 - STA. 866+00, 24.5' RT LANE TAPER BEGINS (RAMP Z)
- 7 - STA. 316+70, 67.0' RT PC
- 8 - STA 314+88.00, 14.5' RT PB ENDS
- 9 - STA. 312+09, 4.5' LT PC
- 10 - STA. 315+51, 25.0' LT PT
- 11 - STA 314+88.00, 17.5' RT LANE TAPER BEGINS
- 12 - STA 316+53.00, 15' RT LANE TAPER ENDS
- 13 - STA. 318+39, 74.5' RT PC
- 1 - STA 13+80
- 2 - STA 14+80
- 3 - STA 15+80
- 4 - STA 16+80
- 5 - STA 17+80

Released for Construction
 Thomas J Powell, PE
 10/04/2021

ISSUE RECORD:		
NO.	DATE	DESCRIPTION

- NOTES:
- FOR LEGEND, SEE SHEET 19
 - ALL STATIONING TAKEN FROM \hat{C} CONSTRUCTION IR 76/IR 77 UNLESS OTHERWISE NOTED
 - FOR DRUM SPACING SEE MT-95.40, TABLE II
 - FOR PB FLARE RATE SEE MT-95.40, TABLE II

p:\VANVAOPWINTO\parsons.com\Ohio State\Documents\DB-Akron Beltway Rehab\0 - Design\02329\MOT\Sheets\BU-05\02329_MPBUS16.dgn Sheet 9/28/2021 12:59:39 PM apilpohuk

Released for Construction
 Thomas J Powell, PE
 10/04/2021

ISSUE RECORD:		
NO.	DATE	DESCRIPTION

CALCULATED VJ
 CHECKED AVP

0 50 100
 HORIZONTAL SCALE IN FEET

- NOTES:
- FOR LEGEND SEE SHEET 19
 - ALL STATIONING TAKEN FROM $\text{\textcircled{C}}$ CONSTRUCTION IR 76/IR 77 UNLESS OTHERWISE NOTED
 - FOR DRUM SPACING SEE MT-95.40, TABLE II
 - FOR PB FLARE RATE SEE MT-95.40, TABLE II

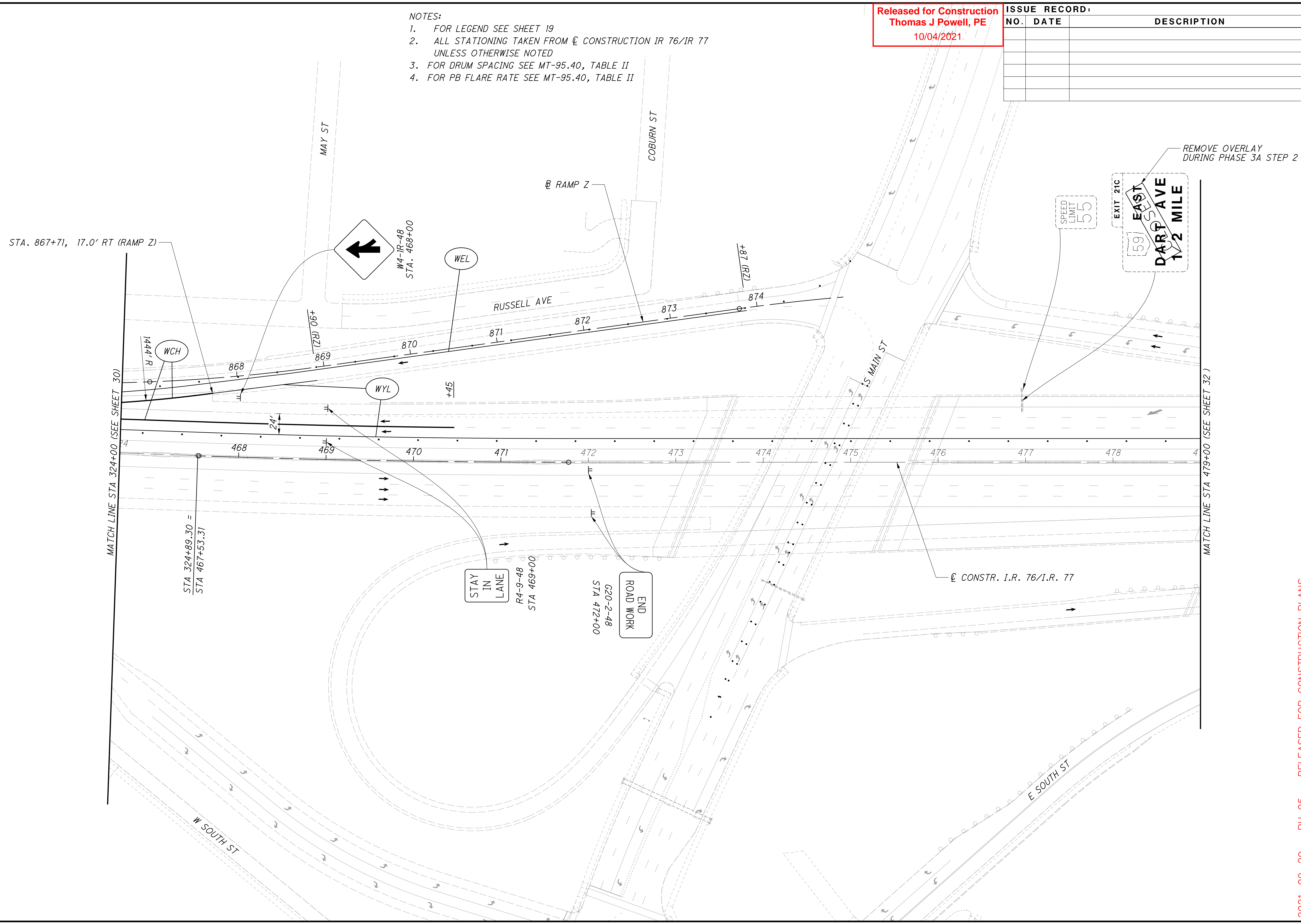

2021-09-29 - BU 05 - RELEASED FOR CONSTRUCTION PLANS

MOT IR 76 / IR 77 PHASE 3A - STEPS 1 & 2
 STA 324+00 TO STA 479+00

SUM-76 / 77 / 8-
 8.24 / 9.74 / 0.00

Released for Construction
 Thomas J Powell, PE
 10/04/2021

ISSUE RECORD:		
NO.	DATE	DESCRIPTION

- NOTES:
- FOR LEGEND, SEE SHEET 19
 - ALL STATIONING TAKEN FROM \varnothing CONSTRUCTION IR 76 UNLESS OTHERWISE NOTED
 - FOR DRUM SPACING SEE MT-95.40, TABLE II
 - FOR PB FLARE RATE SEE MT-95.40, TABLE II

CALCULATED VJ
 CHECKED AVP

0 50 100
 HORIZONTAL SCALE IN FEET

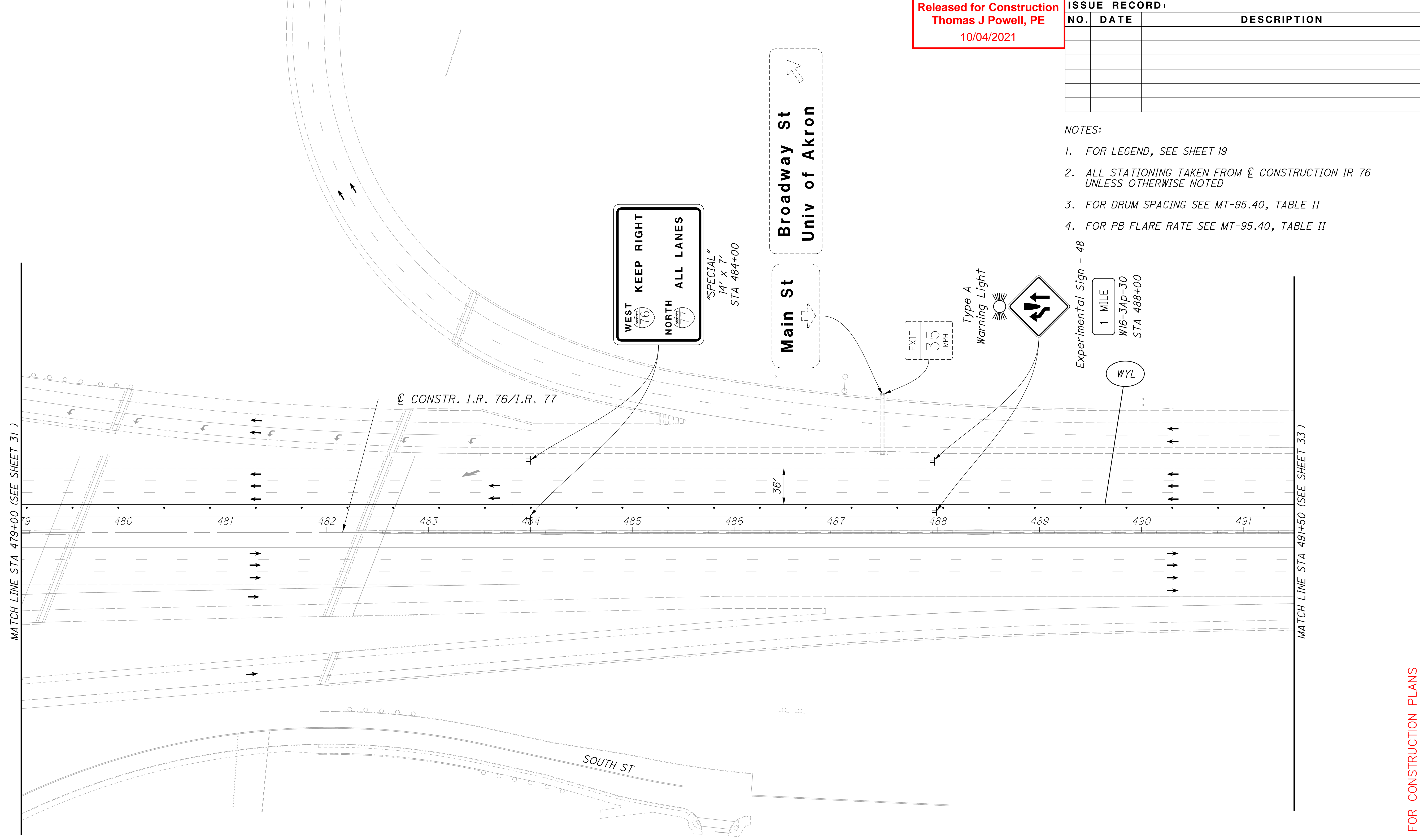

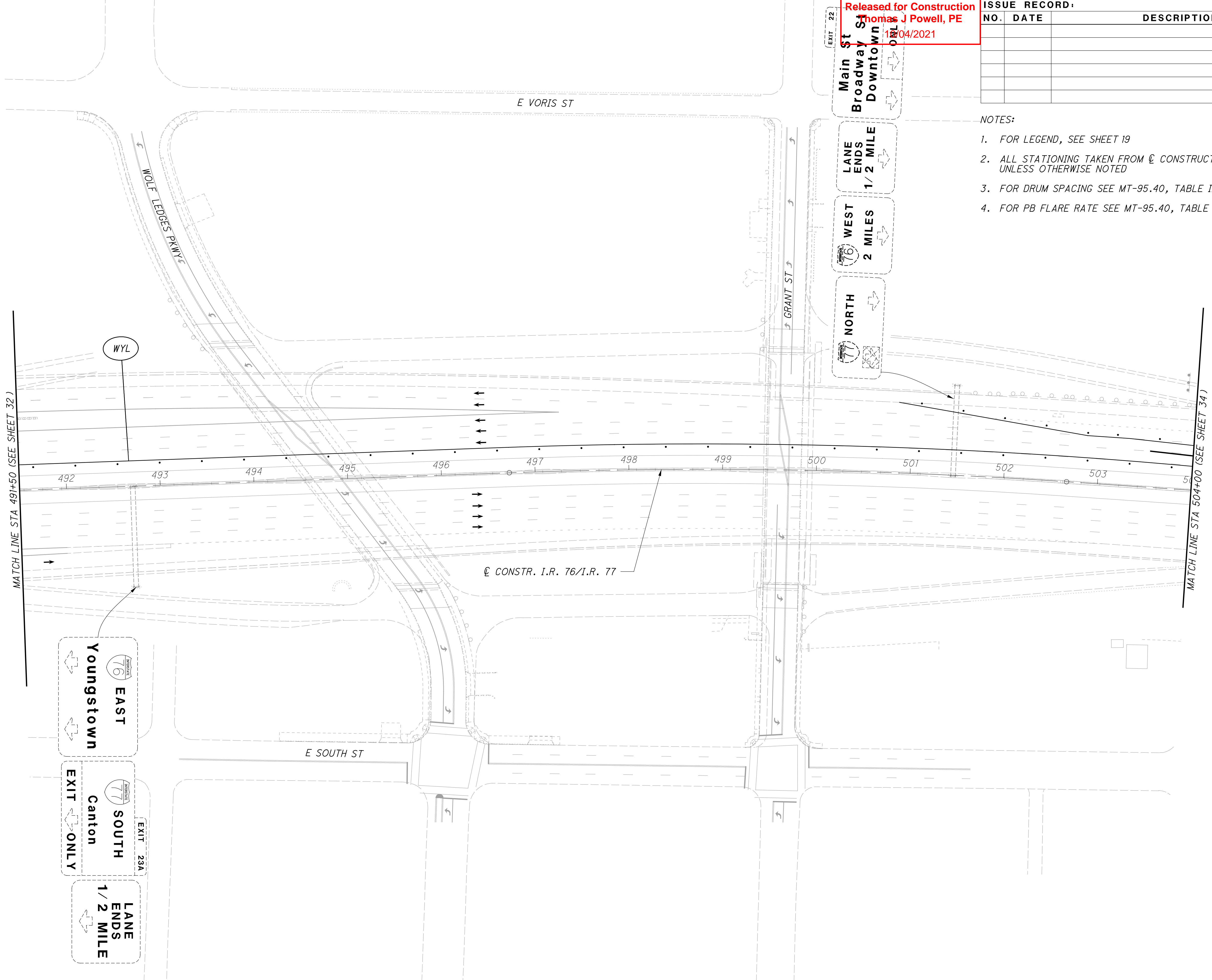

Released for Construction
 Thomas J Powell, PE
 10/04/2021

ISSUE RECORD:

NO.	DATE	DESCRIPTION

- NOTES:**
1. FOR LEGEND, SEE SHEET 19
 2. ALL STATIONING TAKEN FROM \varnothing CONSTRUCTION IR 76 UNLESS OTHERWISE NOTED
 3. FOR DRUM SPACING SEE MT-95.40, TABLE II
 4. FOR PB FLARE RATE SEE MT-95.40, TABLE II

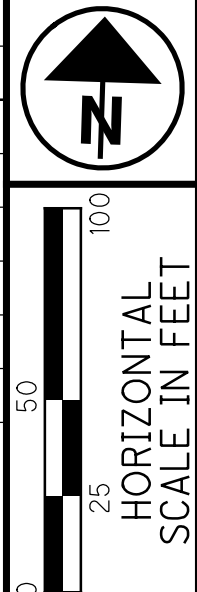

CALCULATED
 V J
 CHECKED
 AVP

d:\va\p\w\int\p\ar sons.com:Ohio State\Documents\DB-Akron Beltway Rehab\0 - Design\02329\MOT\Sheets\BU-05\02329_MPBUI9.dgn Sheet 9/28/2021 10:08 PM apilpchnuk

Released for Construction
 Thomas J Powell, PE
 10/04/2021

ISSUE RECORD:		
NO.	DATE	DESCRIPTION

- NOTES:
- FOR LEGEND, SEE SHEET 19
 - ALL STATIONING TAKEN FROM \varnothing CONSTRUCTION IR 76 UNLESS OTHERWISE NOTED
 - FOR DRUM SPACING SEE MT-95.40, TABLE II
 - FOR PB FLARE RATE SEE MT-95.40, TABLE II



 HORIZONTAL SCALE IN FEET
 CALCULATED VJ
 CHECKED AVP

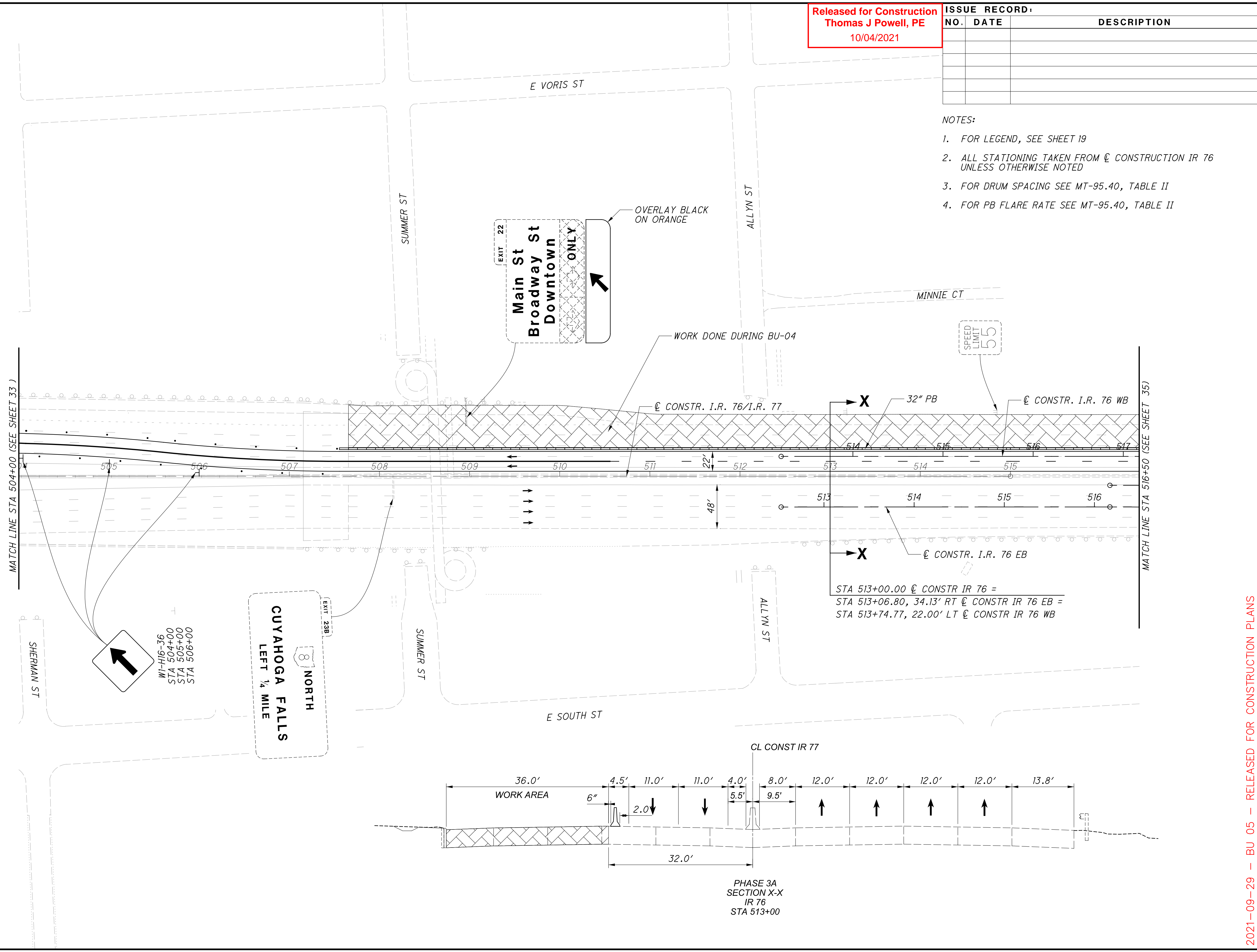

\varnothing CONSTR. I.R. 76/I.R. 77
 \varnothing CONSTR. I.R. 76 WB
 \varnothing CONSTR. I.R. 76 EB
 STA 513+00.00 \varnothing CONSTR IR 76 =
 STA 513+06.80, 34.13' RT \varnothing CONSTR IR 76 EB =
 STA 513+74.77, 22.00' LT \varnothing CONSTR IR 76 WB

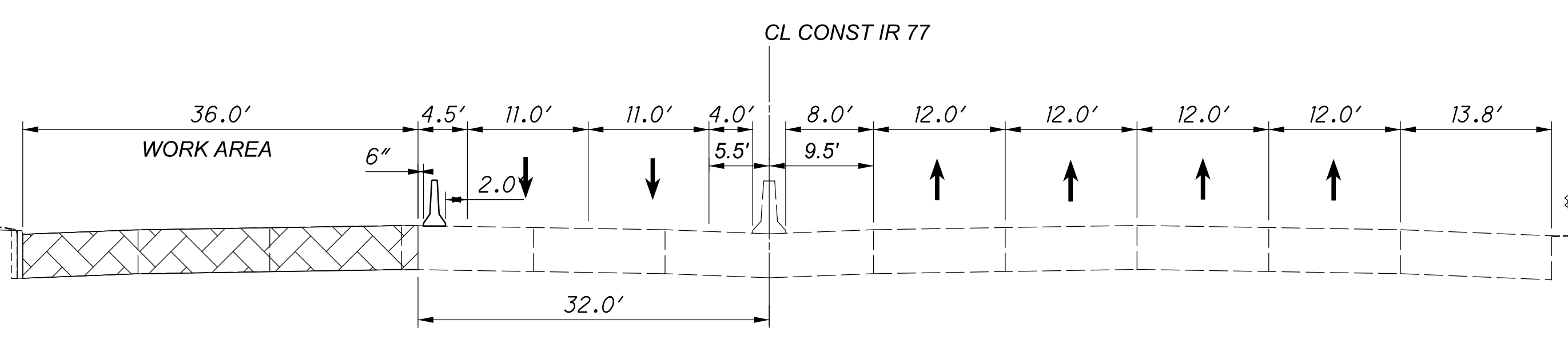

PHASE 3A
 SECTION X-X
 IR 76
 STA 513+00

2021-09-29 - BU 05 - RELEASED FOR CONSTRUCTION PLANS

MOT IR 76 / IR 77 PHASE 3A - STEPS 1 & 2
 STA 504+00 TO STA 516+50

SUM-76/77/8-
 8.24/9.74/0.00

pw:\VANVAOPWINTO\parsons.com:Ohio State\Documents\DB-Akron Beltway Rehab\0 - Design\02329\MOT\Sheets\BU-05\02329_MPB05120.dgn Sheet 9/28/2021 10:08 PM apilpchnuk

Released for Construction
 Thomas J Powell, PE
 10/04/2021

ISSUE RECORD:		
NO.	DATE	DESCRIPTION

- NOTES:
- FOR LEGEND, SEE SHEET 19
 - ALL STATIONING TAKEN FROM \odot CONSTRUCTION IR 76 WB UNLESS OTHERWISE NOTED
 - FOR DRUM SPACING SEE MT-95.40, TABLE II
 - FOR PB FLARE RATE SEE MT-95.40, TABLE II

CALCULATED	VJ
CHECKED	AVP

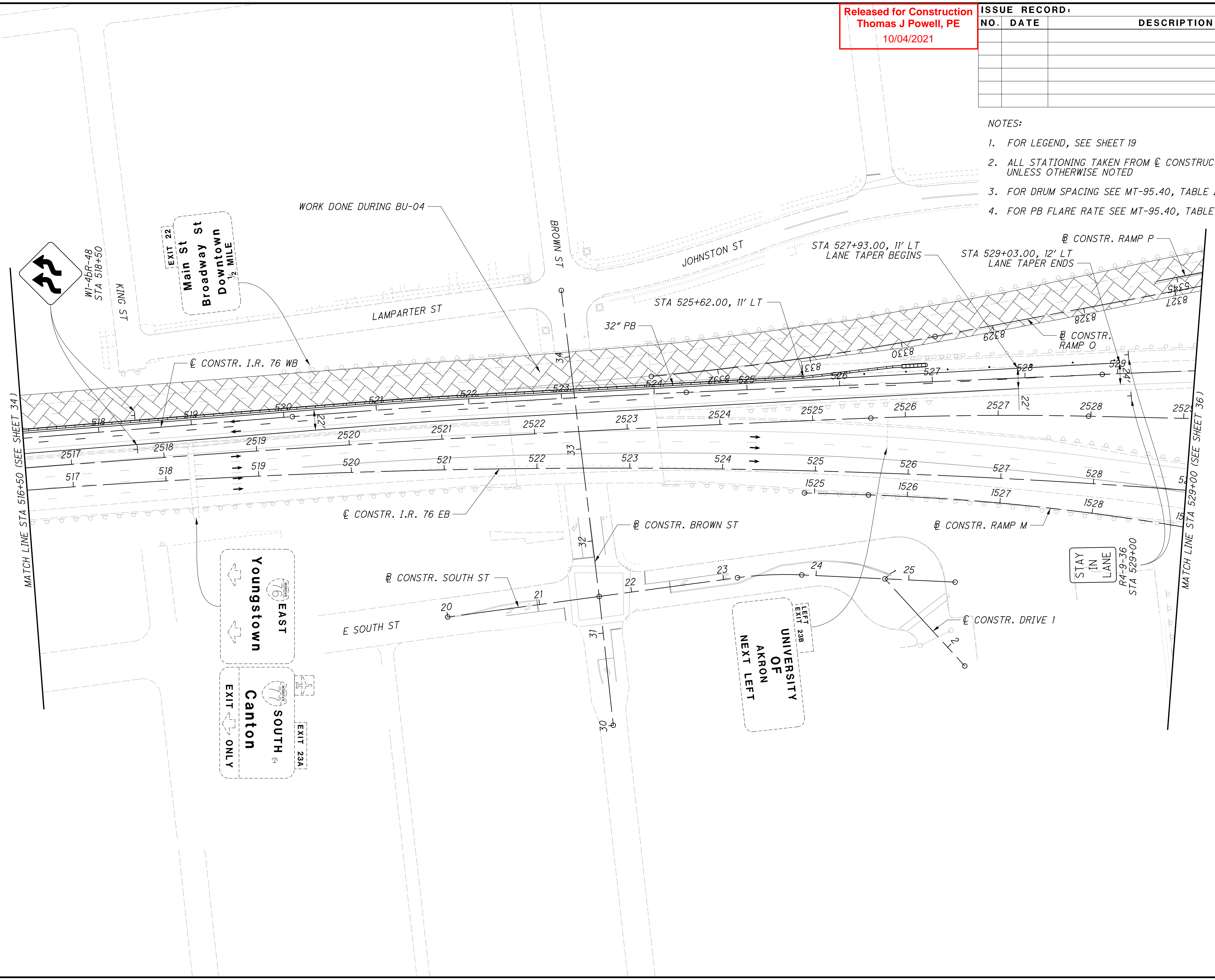

2021-09-29 - BU 05 - RELEASED FOR CONSTRUCTION PLANS

MOT IR 76 / IR 77 PHASE 3A - STEPS 1 & 2
 STA 516+50 TO STA 529+00

SUM-76 / 77 / 8 -
 8.24 / 9.74 / 0.00

\\VANVAOPWINTO\parsons.com\Ohio State\Documents\DB-Akron Beltway Rehab\0 - Design\02329\MOT\Sheets\BU-05\02329.MOT\Sheets\BU-05\02329.MPB\512.dgn Sheet 9/28/2021 10:02:24 PM aplilpchnuk

Released for Construction
Thomas J Powell, PE
10/04/2021

ISSUE RECORD:		
NO.	DATE	DESCRIPTION

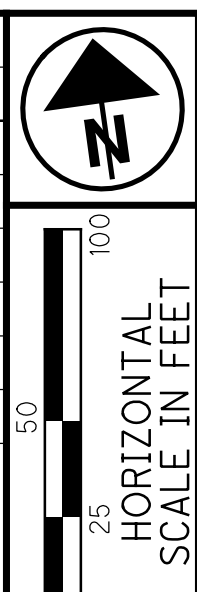

- NOTES:
- FOR LEGEND, SEE SHEET 19
 - ALL STATIONING TAKEN FROM \varnothing CONSTRUCTION IR 76 WB UNLESS OTHERWISE NOTED
 - FOR DRUM SPACING SEE MT-95.40, TABLE II
 - FOR PB FLARE RATE SEE MT-95.40, TABLE II

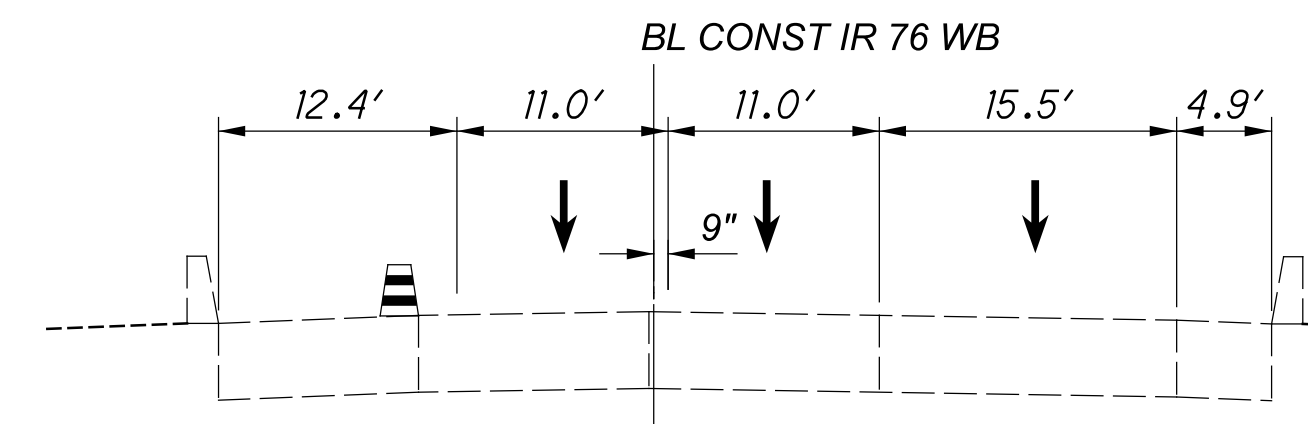
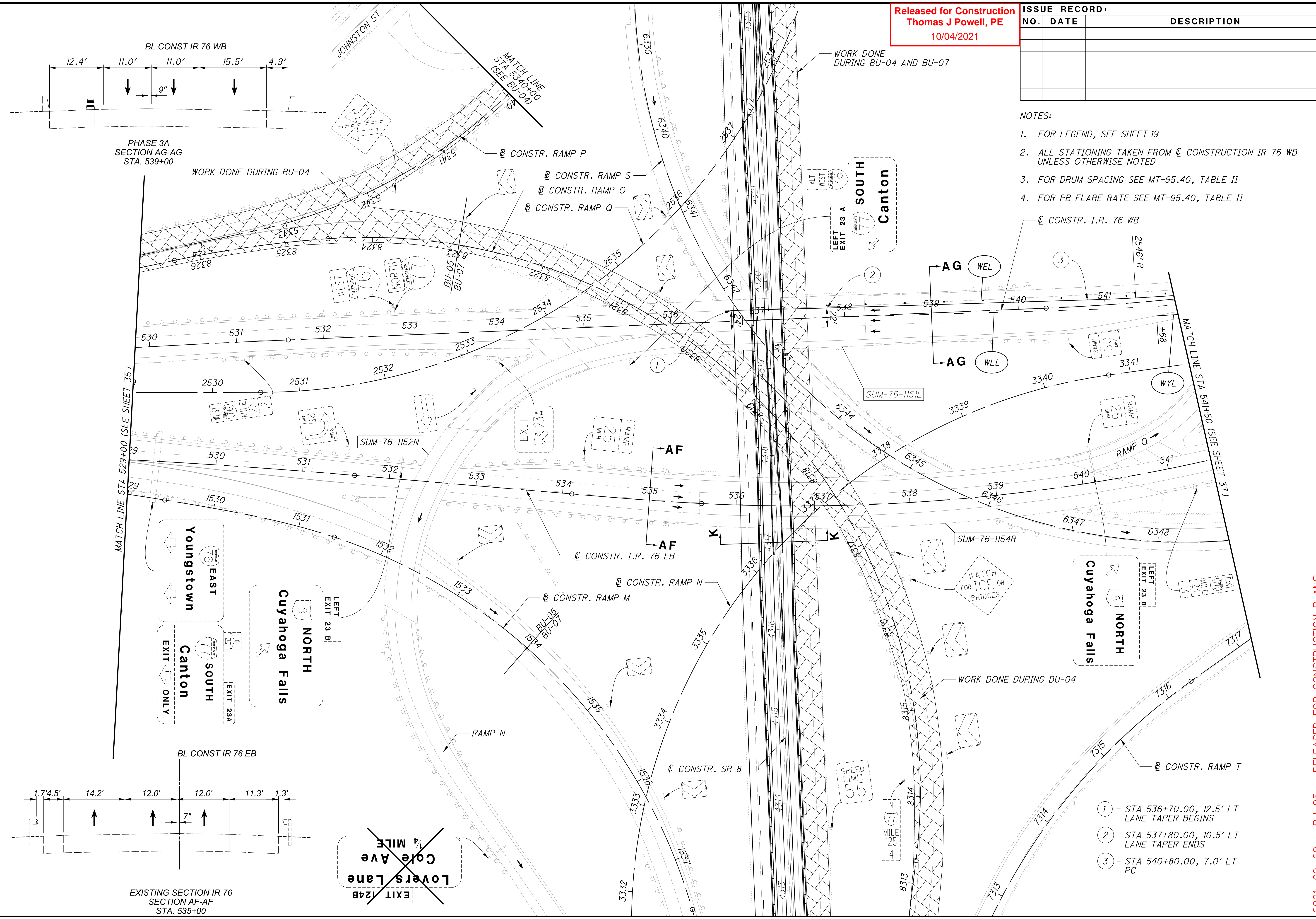

PHASE 3A SECTION AG-AG STA. 539+00

WORK DONE DURING BU-04

WORK DONE DURING BU-04 AND BU-07

MATCH LINE STA 529+00 (SEE SHEET 35)

MATCH LINE STA 541+50 (SEE SHEET 37)

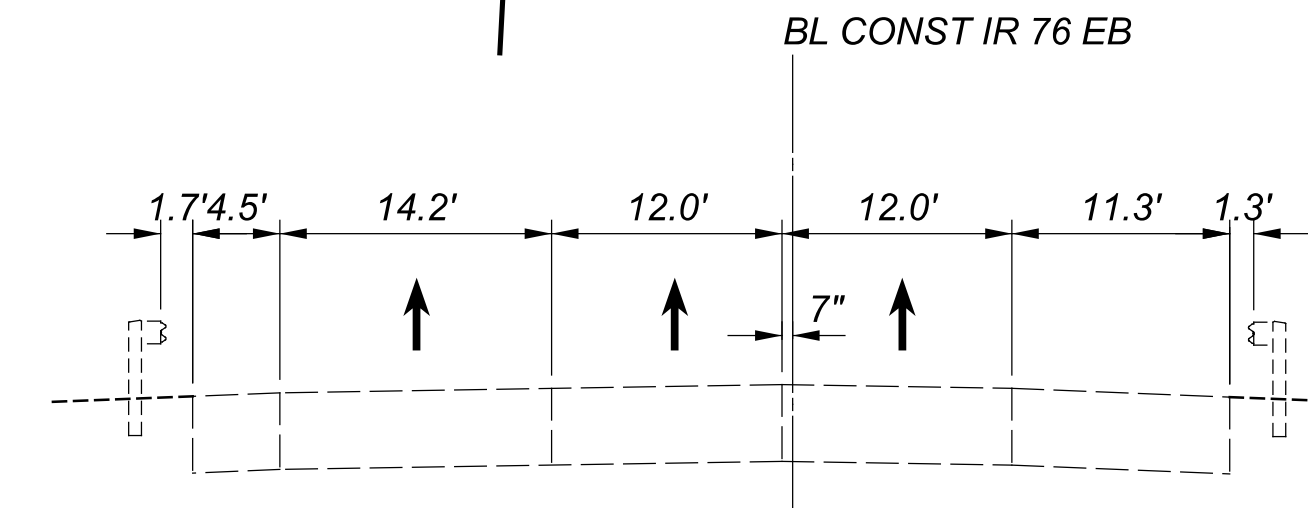

EXISTING SECTION IR 76 SECTION AF-AF STA. 535+00

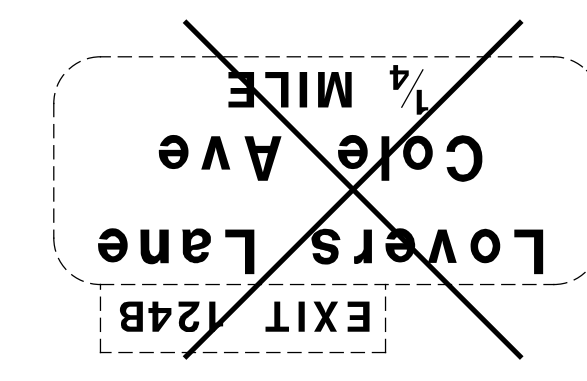

- STA 536+70.00, 12.5' LT LANE TAPER BEGINS
- STA 537+80.00, 10.5' LT LANE TAPER ENDS
- STA 540+80.00, 7.0' LT PC

2021-09-29 - BU 05 - RELEASED FOR CONSTRUCTION PLANS

MOT IR 76 / IR 77 PHASE 3A - STEPS 1 & 2
SUM-76 / 77 / 8 -
8.24 / 9.74 / 0.00
STA 529+00 TO STA 541+50

Released for Construction
 Thomas J Powell, PE
 10/04/2021

ISSUE RECORD:		
NO.	DATE	DESCRIPTION

- NOTES:
- FOR LEGEND, SEE SHEET 19
 - ALL STATIONING TAKEN FROM \odot CONSTRUCTION IR 76 WB UNLESS OTHERWISE NOTED
 - FOR DRUM SPACING SEE MT-95.40, TABLE II
 - FOR PB FLARE RATE SEE MT-95.40, TABLE II

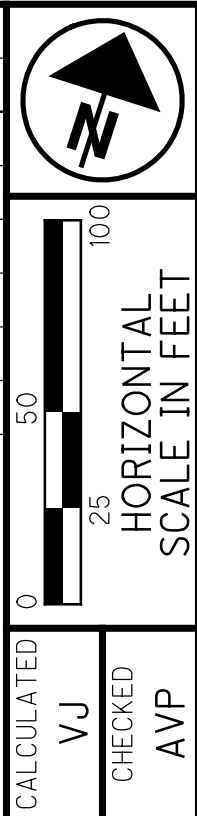

d:\VANVAOP\WINTO\parsons.com\Ohio State\Documents\DB-Akron Beltway Rehab\0 - Design\02329\MOT\Sheets\BU-05\02329.MPB\05123.dgn Sheet 9/28/2021 10:00:35 PM aplipchuk

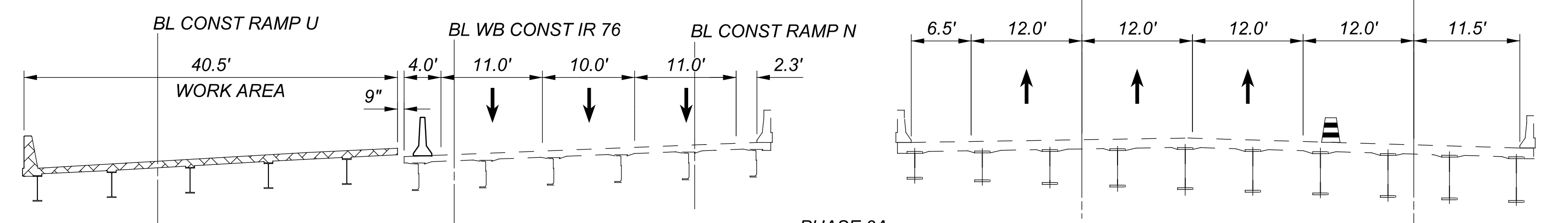
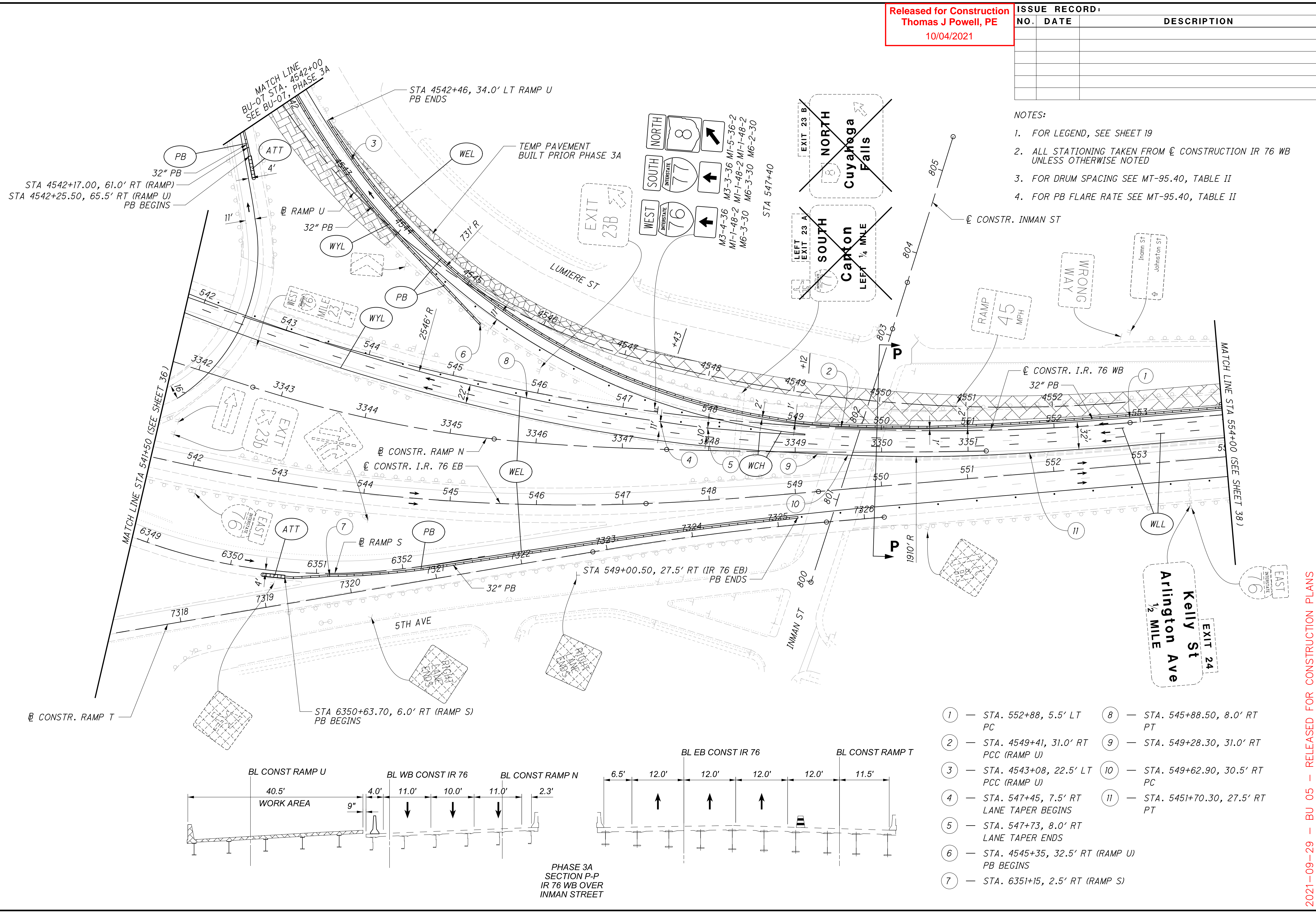

PHASE 3A
 SECTION P-P
 IR 76 WB OVER
 INMAN STREET

- ① — STA. 552+88, 5.5' LT PC
- ② — STA. 4549+41, 31.0' RT PCC (RAMP U)
- ③ — STA. 4543+08, 22.5' LT PCC (RAMP U)
- ④ — STA. 547+45, 7.5' RT LANE TAPER BEGINS
- ⑤ — STA. 547+73, 8.0' RT LANE TAPER ENDS
- ⑥ — STA. 4545+35, 32.5' RT (RAMP U) PB BEGINS
- ⑦ — STA. 6351+15, 2.5' RT (RAMP S)
- ⑧ — STA. 545+88.50, 8.0' RT PT
- ⑨ — STA. 549+28.30, 31.0' RT PCC (RAMP U)
- ⑩ — STA. 549+62.90, 30.5' RT PC
- ⑪ — STA. 5451+70.30, 27.5' RT PT

2021-09-29 - BU 05 - RELEASED FOR CONSTRUCTION PLANS

MOT IR 76 / IR 77 PHASE 3A - STEPS 1 & 2
 STA 541+50 TO STA 554+00

SUM-76/77/8-
 8.24/9.74/0.00

d:\va\vaipwintol\parsons.com\Ohio State\Documents\DB-Akron Beltway Rehab\10 - Design\02329\MOT\Sheets\BU-05\02329.MPB\05124.dgn Sheet 9/28/2021 10:00:51 PM aplipchuk

Released for Construction
 Thomas J Powell, PE
 10/04/2021

ISSUE RECORD:		
NO.	DATE	DESCRIPTION

- NOTES:
- FOR LEGEND, SEE SHEET 19
 - ALL STATIONING TAKEN FROM \varnothing CONSTRUCTION IR 76 WB UNLESS OTHERWISE NOTED
 - FOR DRUM SPACING SEE MT-95.40, TABLE II
 - FOR PB FLARE RATE SEE MT-95.40, TABLE II

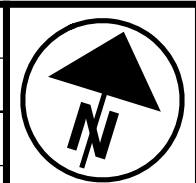

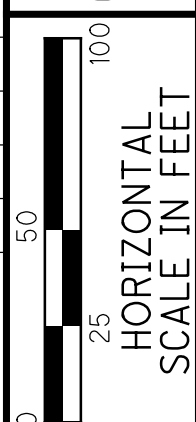

 CALCULATED VJ
 CHECKED AVP

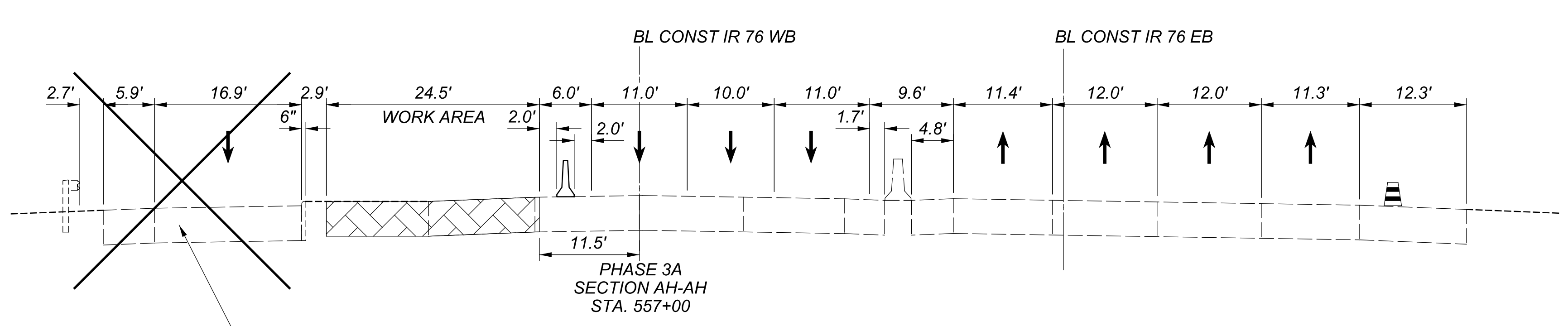
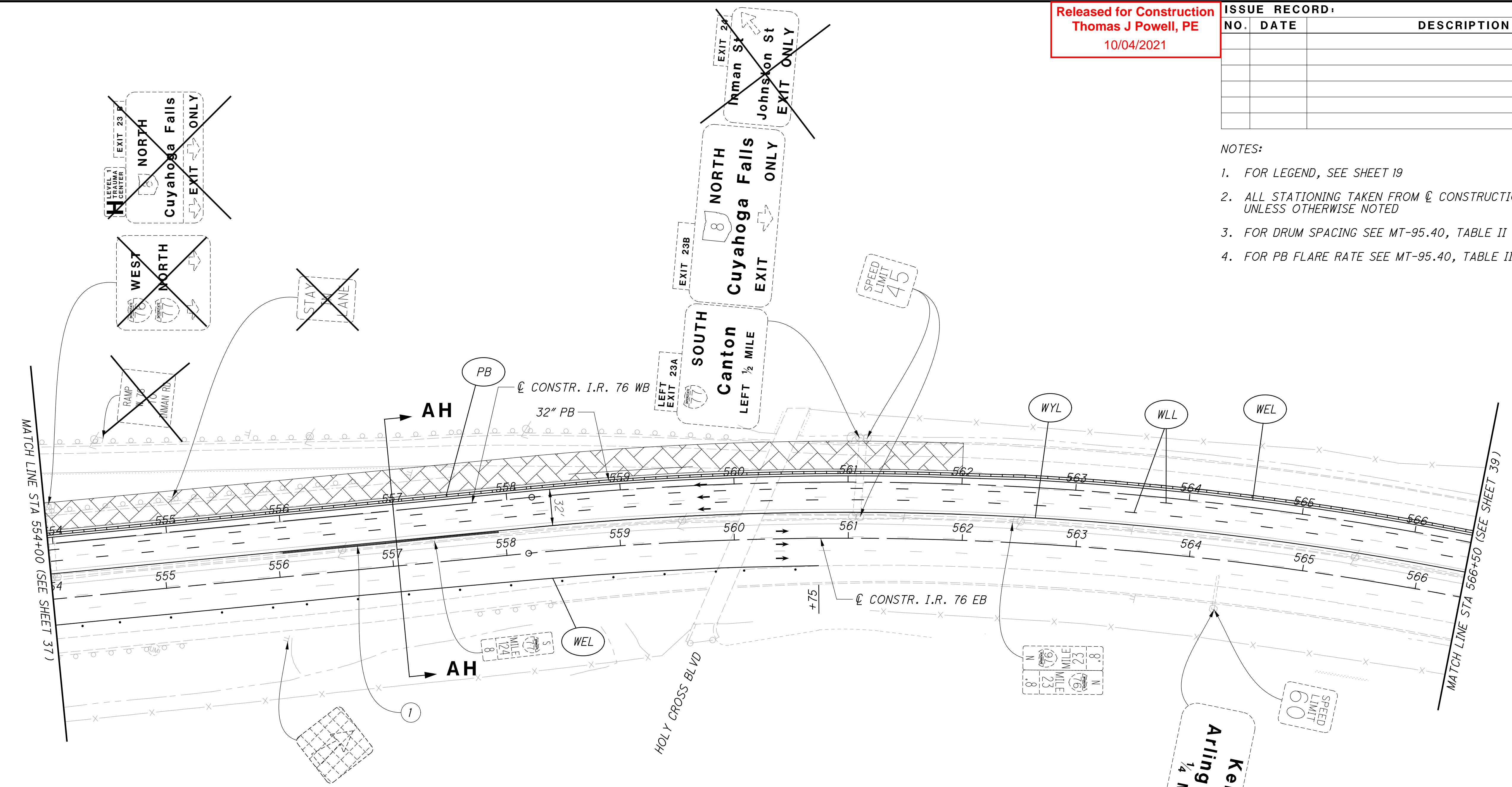

Kelly St
 Arlington Ave
 1/4 MILE
 EXIT 24

① — TROUGH, WIDTH - 9.5", DEPTH - 1.5", LENGTH 190'
 BEGIN STA. 557+90
 END STA. 556+00

2021-09-29 - BU 05 - RELEASED FOR CONSTRUCTION PLANS

MOT IR 76 / IR 77 PHASE 3A - STEPS 1 & 2
 STA 554+00 TO STA 566+50

SUM-76/77/8-
 8.24/9.74/0.00

pw:\VANVAOPWINTO\parsons.com:Ohio State\Documents\DB-Akron Beltway Rehab\10 - Design\02329\M0T\Sheets\BU-05\02329_MPB\05125.dgn_Sheet 9/28/2021 10:00 PM apilpchnuk

- NOTES:
- FOR LEGEND, SEE SHEET 19
 - ALL STATIONING TAKEN FROM \varnothing CONSTRUCTION IR 76 WB UNLESS OTHERWISE NOTED
 - FOR DRUM SPACING SEE MT-95.40, TABLE II
 - FOR PB FLARE RATE SEE MT-95.40, TABLE II

Released for Construction
 Thomas J Powell, PE
 10/04/2021

ISSUE RECORD:		
NO.	DATE	DESCRIPTION

CALCULATED	VJ
CHECKED	AVP

HORIZONTAL SCALE IN FEET

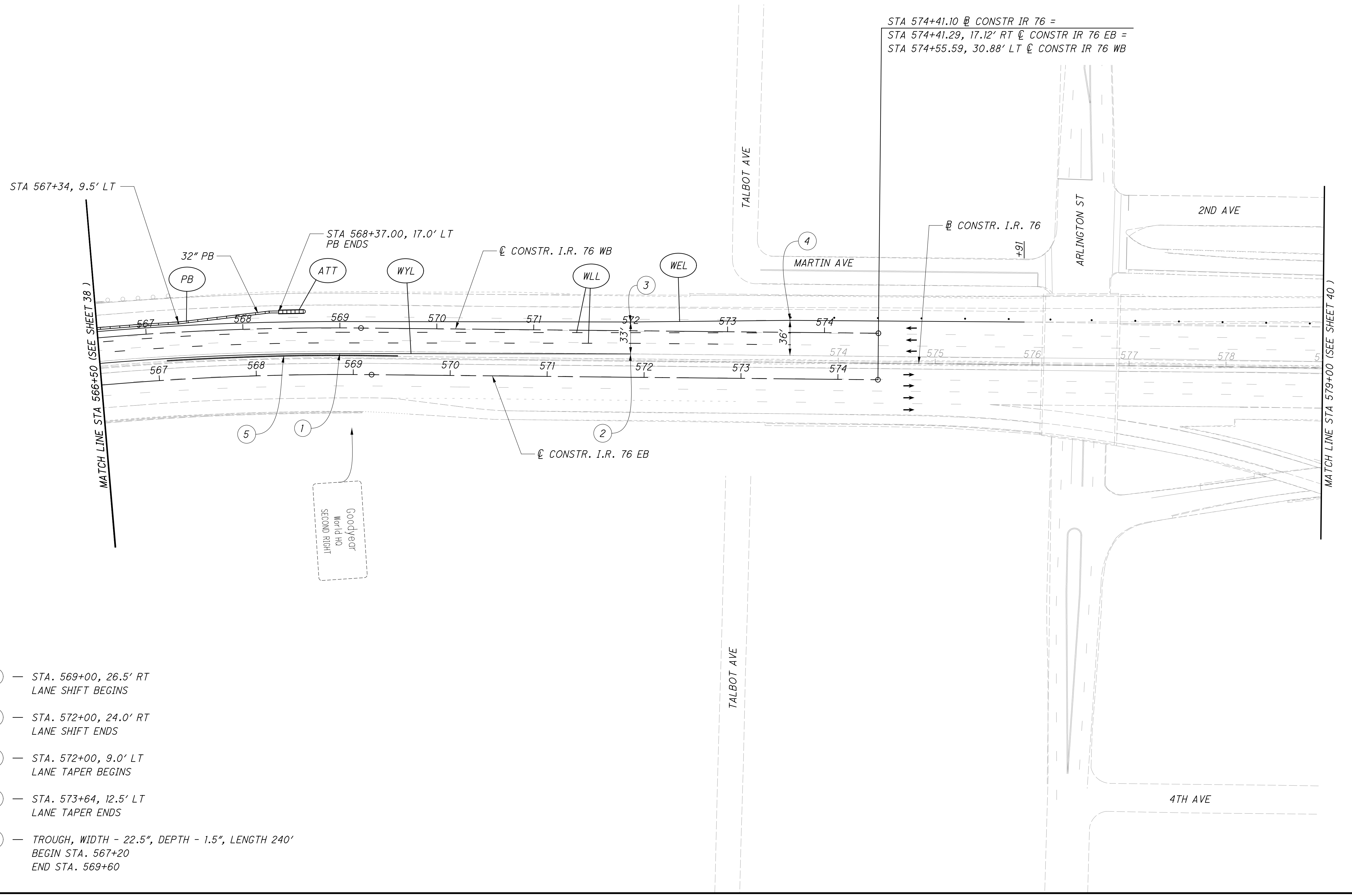

STA 574+41.10 \varnothing CONSTR IR 76 =
 STA 574+41.29, 17.12' RT \varnothing CONSTR IR 76 EB =
 STA 574+55.59, 30.88' LT \varnothing CONSTR IR 76 WB

- ① — STA. 569+00, 26.5' RT LANE SHIFT BEGINS
- ② — STA. 572+00, 24.0' RT LANE SHIFT ENDS
- ③ — STA. 572+00, 9.0' LT LANE TAPER BEGINS
- ④ — STA. 573+64, 12.5' LT LANE TAPER ENDS
- ⑤ — TROUGH, WIDTH - 22.5', DEPTH - 1.5", LENGTH 240' BEGIN STA. 567+20 END STA. 569+60

2021-09-29 - BU 05 - RELEASED FOR CONSTRUCTION PLANS

MOT IR 76 / IR 77 PHASE 3A - STEPS 1 & 2
 STA 566+50 TO STA 579+00

SUM-76/77/8-
 8.24/9.74/0.00

d:\VANVAOPWINTO\parsons.com\Ohio State\Documents\DB-Akron Beltway Rehab\10 - Design\102329\M0T\Sheets\BU-05\102329_MPBUI5126.dgn Sheet 9/28/2021 10:09 PM aplipchuk

Released for Construction
Thomas J Powell, PE
10/04/2021

ISSUE RECORD:		
NO.	DATE	DESCRIPTION

- NOTES:
1. FOR LEGEND, SEE SHEET 19
 2. ALL STATIONING TAKEN FROM CONSTR. I.R. 76 UNLESS OTHERWISE NOTED
 3. FOR DRUM SPACING SEE MT-95.40, TABLE II
 4. FOR PB FLARE RATE SEE MT-95.40, TABLE II

CALCULATED VJ
CHECKED AVP

0 50 100
HORIZONTAL SCALE IN FEET

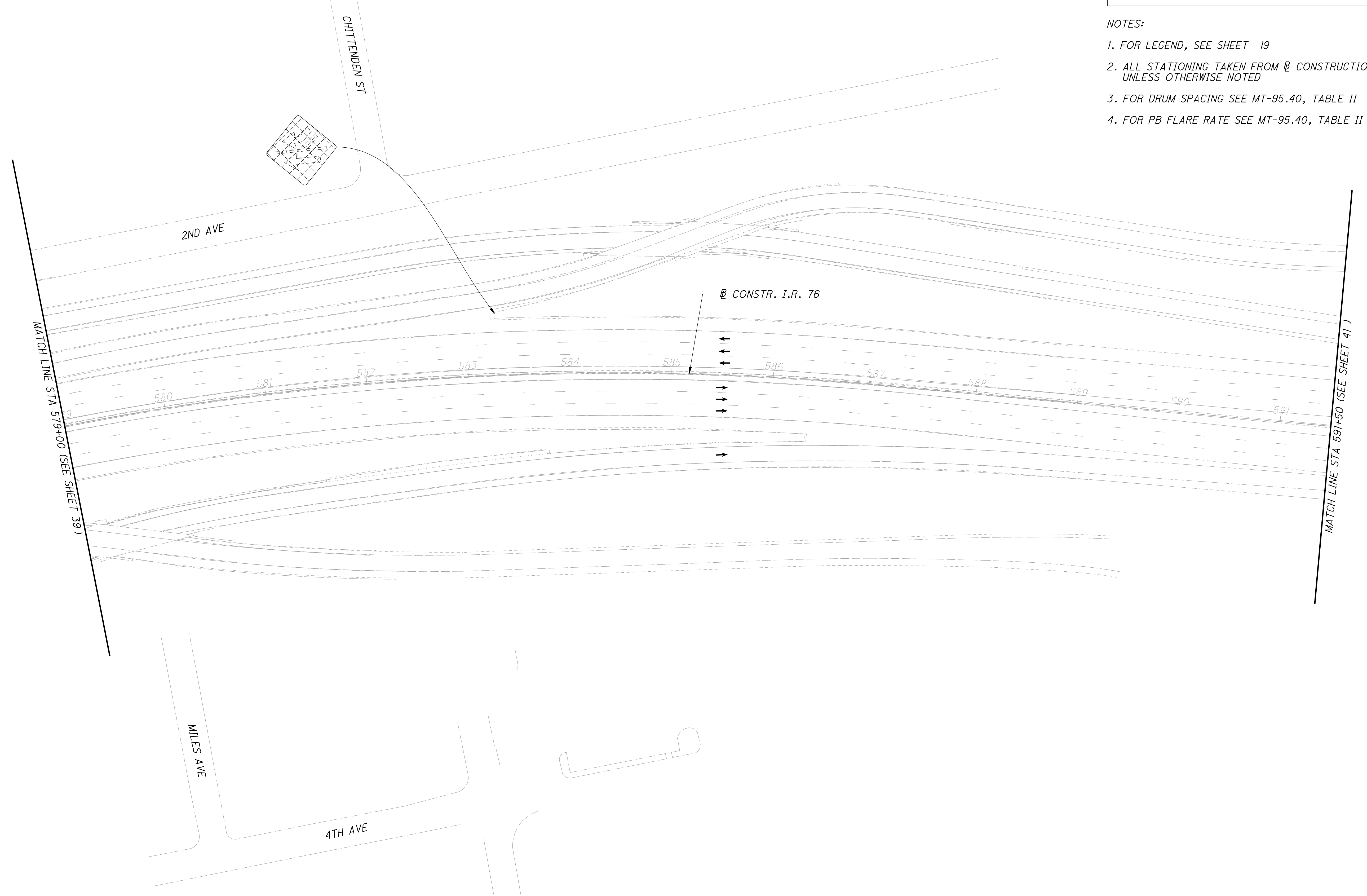

2021-09-29 - BU 05 - RELEASED FOR CONSTRUCTION PLANS

SUM-76 / 77 / 8-
8.24 / 9.74 / 0.00

MOT IR 76 / IR 77 PHASE 3A - STEPS 1 & 2
STA 579+00 TO STA 591+50

40
105

Released for Construction
 Thomas J Powell, PE
 10/04/2021

ISSUE RECORD:		
NO.	DATE	DESCRIPTION

- NOTES:
- FOR LEGEND, SEE SHEET 19
 - ALL STATIONING TAKEN FROM CONSTRUCTION IR 76 UNLESS OTHERWISE NOTED
 - FOR DRUM SPACING SEE MT-95.40, TABLE II
 - FOR PB FLARE RATE SEE MT-95.40, TABLE II

CALCULATED VJ CHECKED AVP

0 25 50 100
 HORIZONTAL SCALE IN FEET

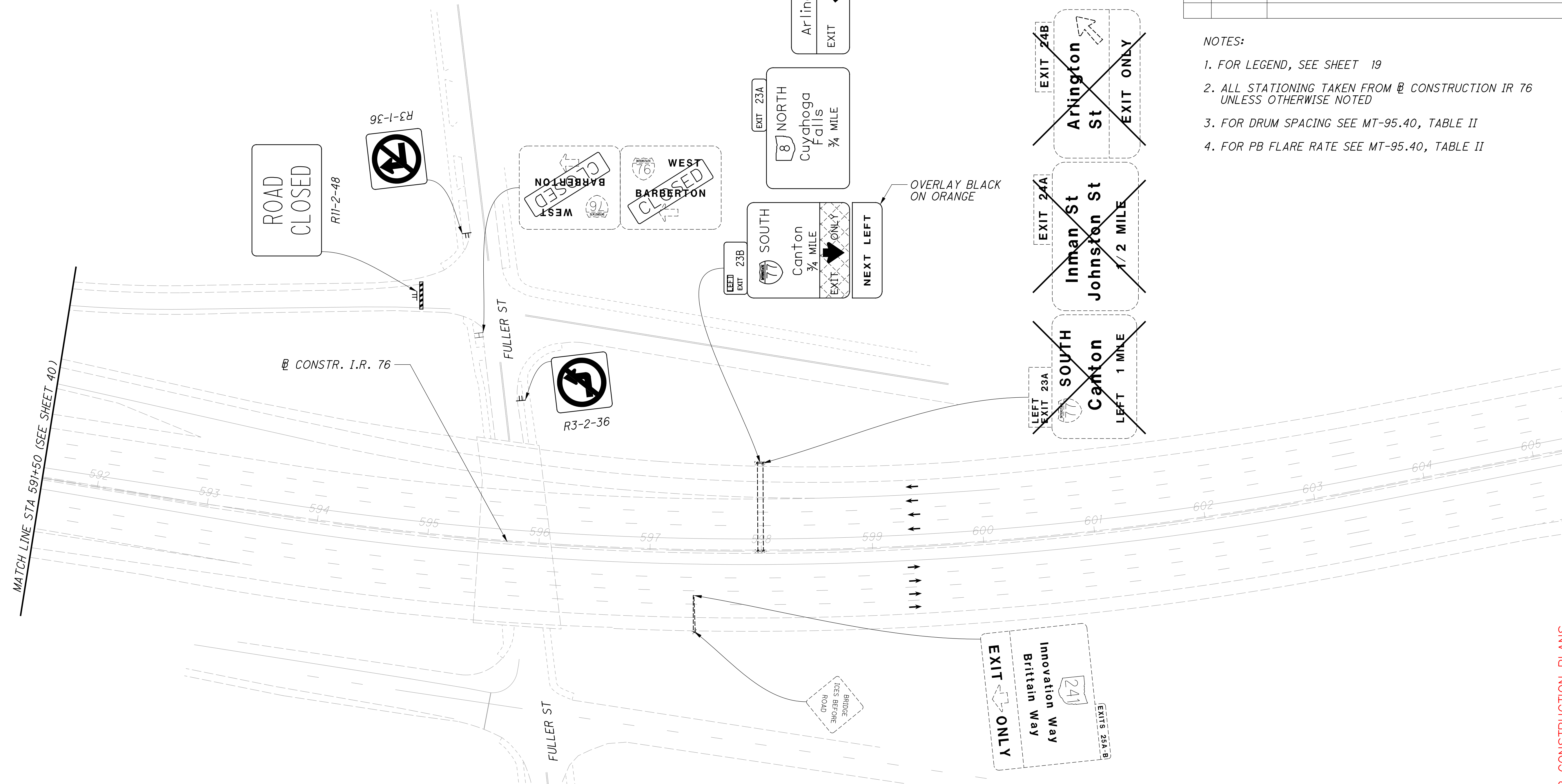

ADVANCE WARNING SIGNS (IR 76 WB SIDE)

Type A Warning Light

ROAD WORK AHEAD

W20-1-48

1 MILE

W16-3aP-30
 STA. 614+50

EXTRA ADVANCE WARNING SIGN (IR 76 WB SIDE)

Type A Warning Light

ROAD WORK AHEAD

W20-1-48
 STA. 667+50

2021-09-29 - BU 05 - RELEASED FOR CONSTRUCTION PLANS

MOT IR 76 / IR 77 PHASE 3A - STEPS 1 & 2
 STA 591+50 TO STA 604+00

SUM-76/77/8-
 8.24/9.74/0.00

\\VANVAIPWINTO\parsons.com\Ohio State\Documents\B-Akron Beltway Rehab\0 - Design\02329\W0T\Sheets\BU-05\02329_MPBUII3.dgn Sheet 9/28/2021 10:26 PM aplipchuk

Released for Construction
Thomas J Powell, PE
10/04/2021

ISSUE RECORD:		
NO.	DATE	DESCRIPTION

- NOTES:
- FOR LEGEND, SEE SHEET 19
 - ALL STATIONING TAKEN FROM CL IR 76/IR 77 UNLESS OTHERWISE NOTED
 - FOR DRUM SPACING SEE MT-95.40, TABLE II
 - FOR PB FLARE RATE SEE MT-95.40, TABLE II

HORIZONTAL SCALE IN FEET

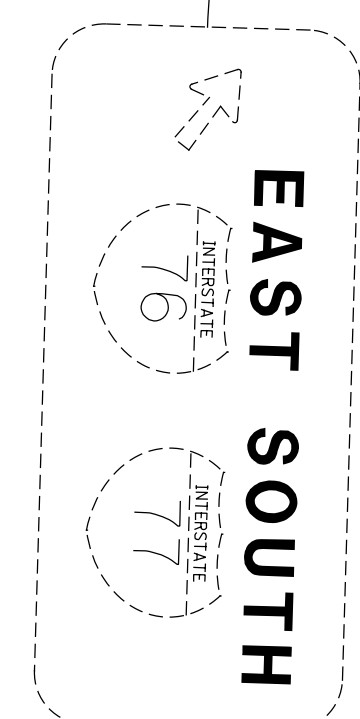
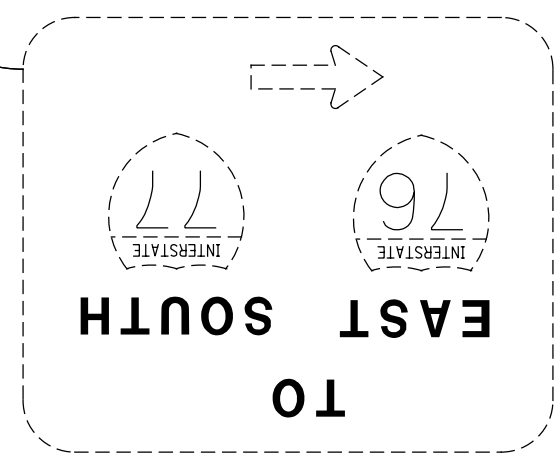
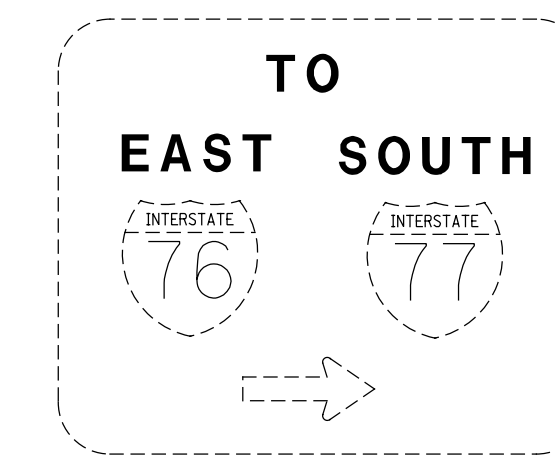
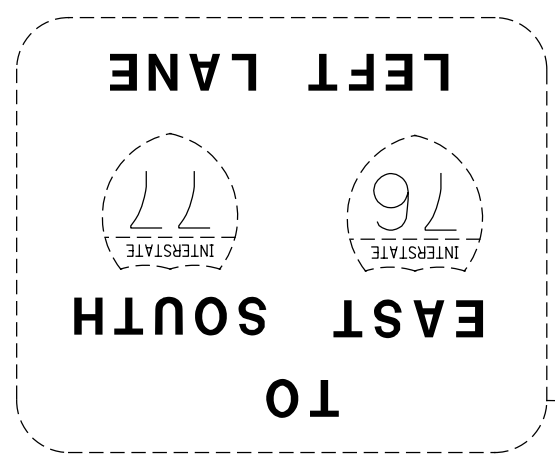
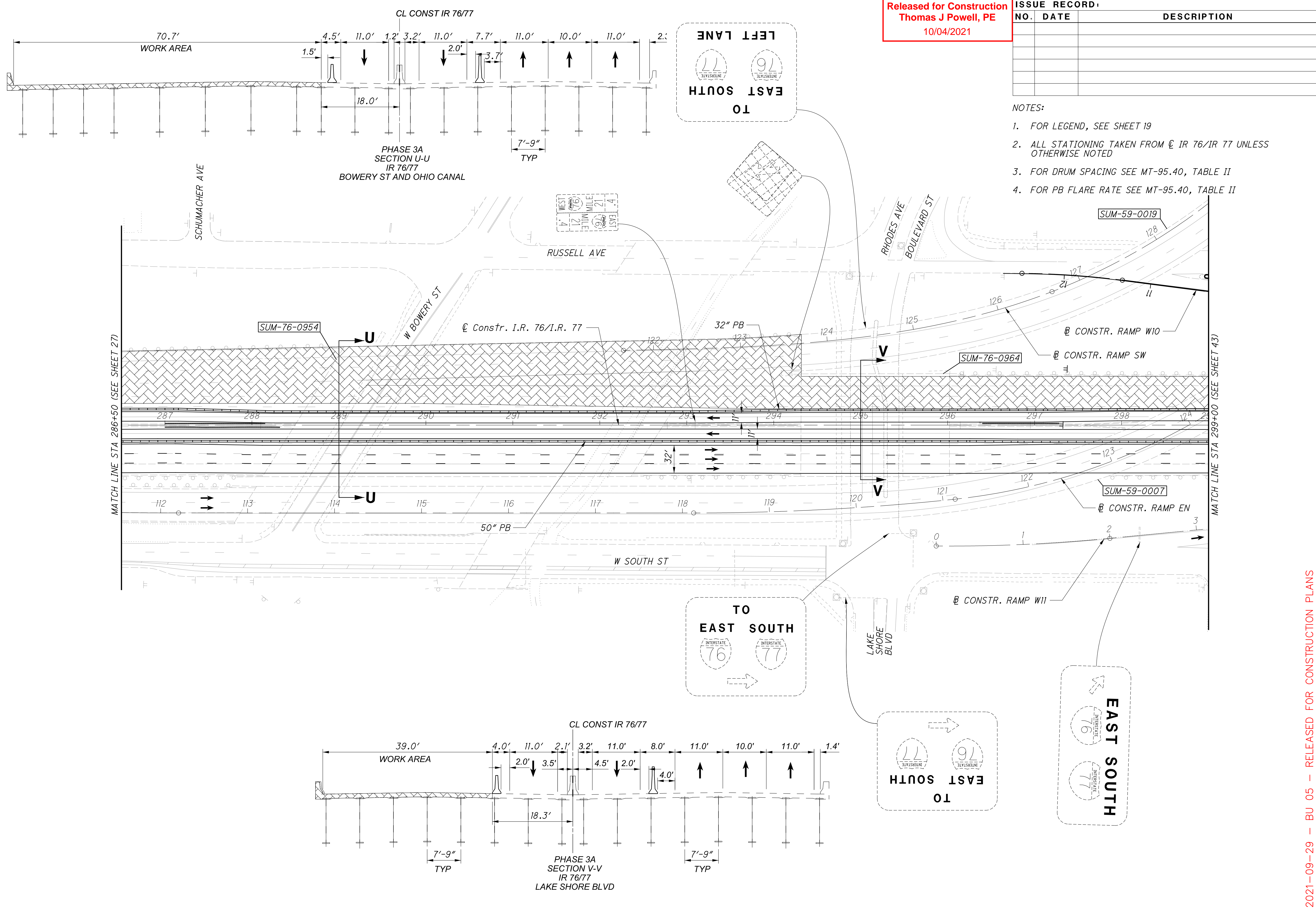

2021-09-29 - BU 05 - RELEASED FOR CONSTRUCTION PLANS

MOT IR 76 / IR 77 PHASE 3A - STEP 2
STA 286+50 TO STA 299+00

SUM-76/77/8-
8.24/9.74/0.00

d:\va\vaip\wintol\parsons.com\Ohio State\Documents\DB-Akron Beltway Rehab\10 - Design\02329\MOT\Sheets\BU-05\02329_MPB\5114.dgn Sheet 9/28/2021 10:35 PM aplipchuk

Released for Construction
 Thomas J Powell, PE
 10/04/2021

ISSUE RECORD:		
NO.	DATE	DESCRIPTION

- NOTES:
- FOR LEGEND, SEE SHEET 19
 - ALL STATIONING TAKEN FROM CL IR 76/IR 77 UNLESS OTHERWISE NOTED
 - FOR DRUM SPACING SEE MT-95.40, TABLE II
 - FOR PB FLARE RATE SEE MT-95.40, TABLE II

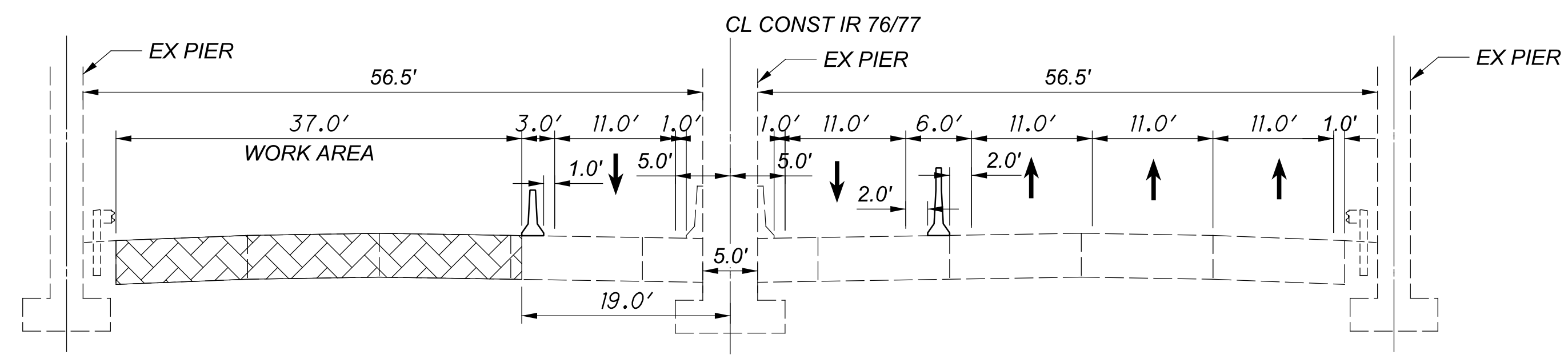
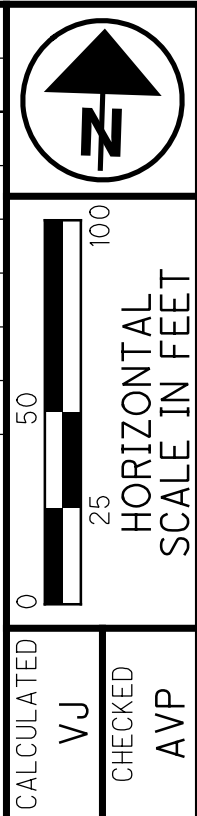

PHASE 3A STEPS 1 AND 2
 SECTION H-H
 IR 76/77
 UNDER SR 59

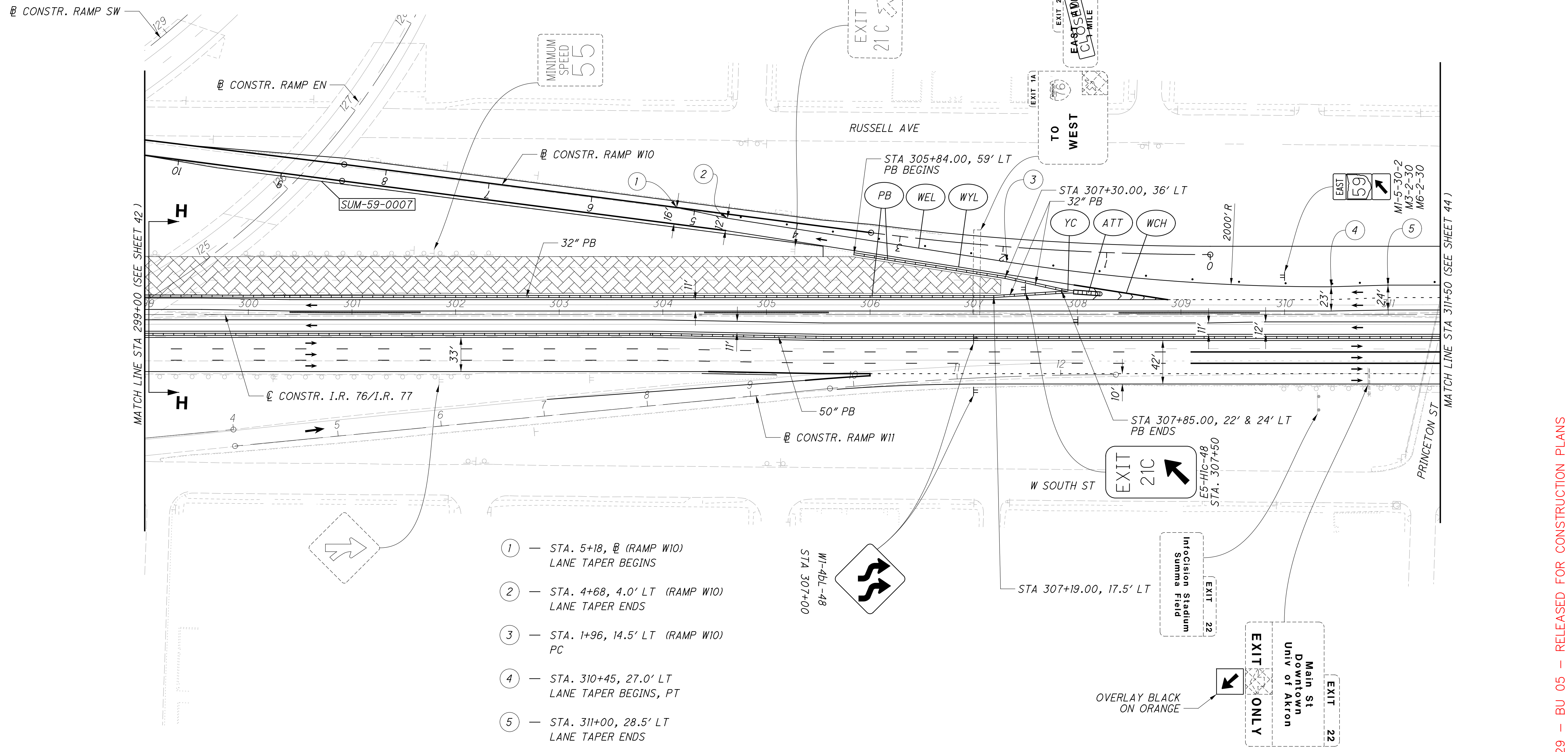

- ① — STA. 5+18, @ (RAMP W10) LANE TAPER BEGINS
- ② — STA. 4+68, 4.0' LT (RAMP W10) LANE TAPER ENDS
- ③ — STA. 1+96, 14.5' LT (RAMP W10) PC
- ④ — STA. 310+45, 27.0' LT LANE TAPER BEGINS, PT
- ⑤ — STA. 311+00, 28.5' LT LANE TAPER ENDS

2021-09-29 - BU 05 - RELEASED FOR CONSTRUCTION PLANS

MOT IR 76 / IR 77 PHASE 3A - STEP 2
 STA 299+00 TO STA 311+50

SUM-76 / 77 / 8-
 8.24 / 9.74 / 0.00

Released for Construction
 Thomas J Powell, PE
 10/04/2021

ISSUE RECORD:		
NO.	DATE	DESCRIPTION

CALCULATED VJ CHECKED AVP

HORIZONTAL SCALE IN FEET

- NOTES:
- FOR LEGEND, SEE SHEET 19
 - ALL STATIONING TAKEN FROM CL IR 76/IR 77 UNLESS OTHERWISE NOTED
 - FOR DRUM SPACING SEE MT-95.40, TABLE II
 - FOR PB FLARE RATE SEE MT-95.40, TABLE II

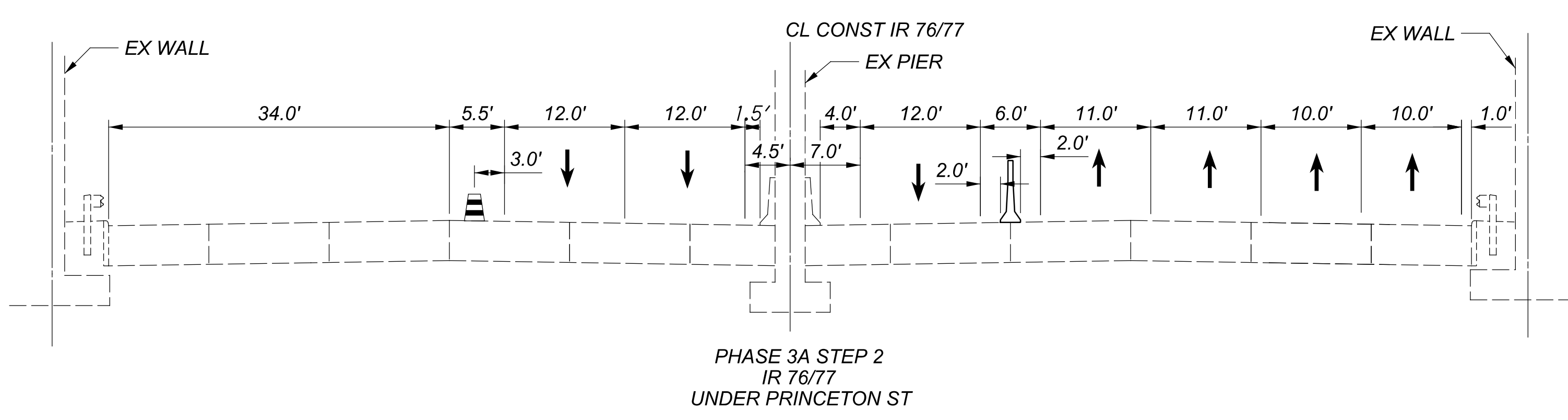

PHASE 3A STEP 2
 IR 76/77
 UNDER PRINCETON ST

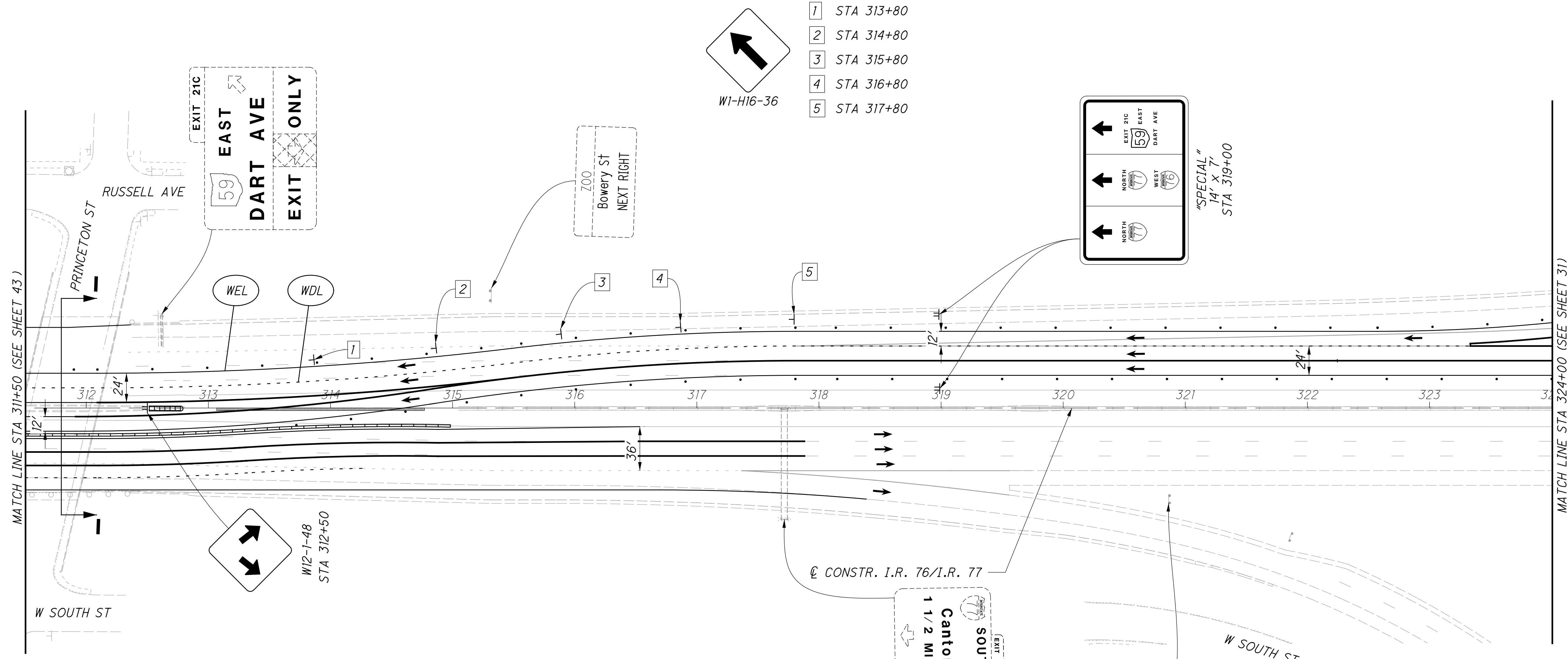

-
- W1-H16-36
- 1 STA 313+80
 - 2 STA 314+80
 - 3 STA 315+80
 - 4 STA 316+80
 - 5 STA 317+80

"SPECIAL" #
 14' X 7'
 STA 319+00

d:\VANVAIPWINTO\parsons.com\Ohio State\Documents\DB-Akron Beltway Rehab\10 - Design\02329\M0T\Sheets\BU-05\02329_MPBUS218.dgn_Sheet 10/4/2021 6:55:12 AM aplilpchnk

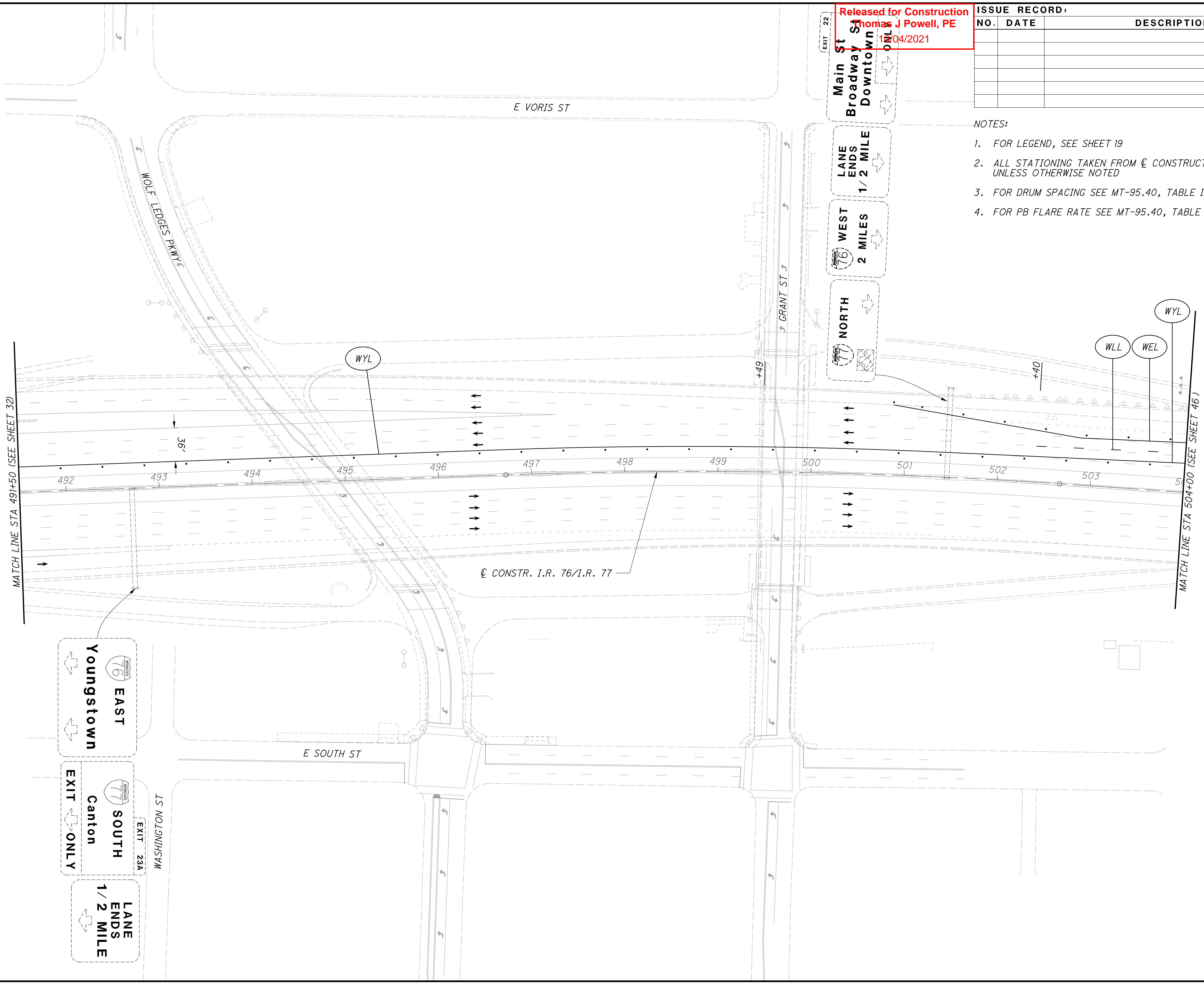

Released for Construction
Thomas J Powell, PE
10/04/2021

ISSUE RECORD:		
NO.	DATE	DESCRIPTION

- NOTES:
1. FOR LEGEND, SEE SHEET 19
 2. ALL STATIONING TAKEN FROM \varnothing CONSTRUCTION IR 76 UNLESS OTHERWISE NOTED
 3. FOR DRUM SPACING SEE MT-95.40, TABLE II
 4. FOR PB FLARE RATE SEE MT-95.40, TABLE II



 CALCULATED VJ
 CHECKED AVP

2021-09-29 - BU 05 - RELEASED FOR CONSTRUCTION PLANS

SUM-76 / 77 / 8 -
8.24 / 9.74 / 0.00

MOT IR 76 / IR 77 PHASE 3B
STA 491+50 TO STA 504+00

45
105

Released for Construction
 Thomas J Powell, PE
 10/04/2021

ISSUE RECORD:		
NO.	DATE	DESCRIPTION

- NOTES:
- FOR LEGEND, SEE SHEET 19
 - ALL STATIONING TAKEN FROM ϕ CONSTRUCTION IR 76 UNLESS OTHERWISE NOTED
 - FOR DRUM SPACING SEE MT-95.40, TABLE II
 - FOR PB FLARE RATE SEE MT-95.40, TABLE II

CALCULATED VJ CHECKED AVP

0 50 100
 25
 HORIZONTAL SCALE IN FEET



- 1 - STA 504+20
- 2 - STA 505+20
- 3 - STA 506+20
- 4 - STA 507+20

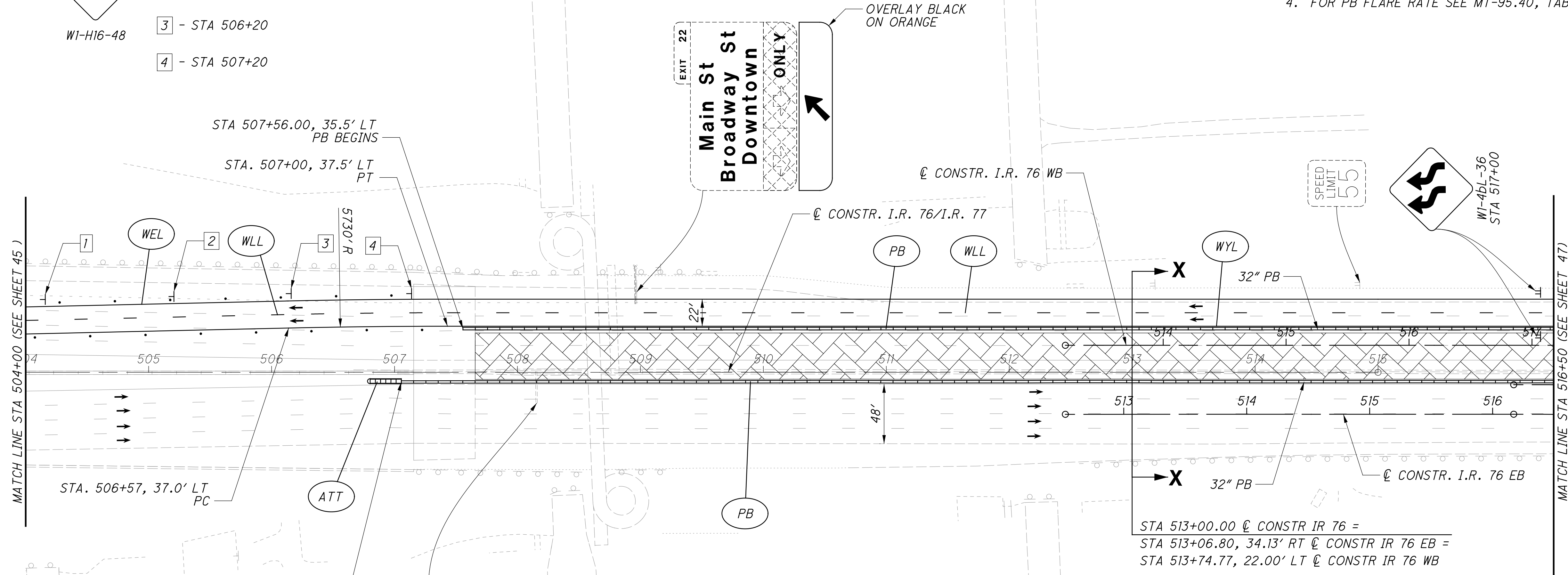

STA 513+00.00 ϕ CONSTR IR 76 =
 STA 513+06.80, 34.13' RT ϕ CONSTR IR 76 EB =
 STA 513+74.77, 22.00' LT ϕ CONSTR IR 76 WB

~~CUYAHOGA FALLS NORTH~~
 LEFT 1/4 MILE
 EXIT 23B

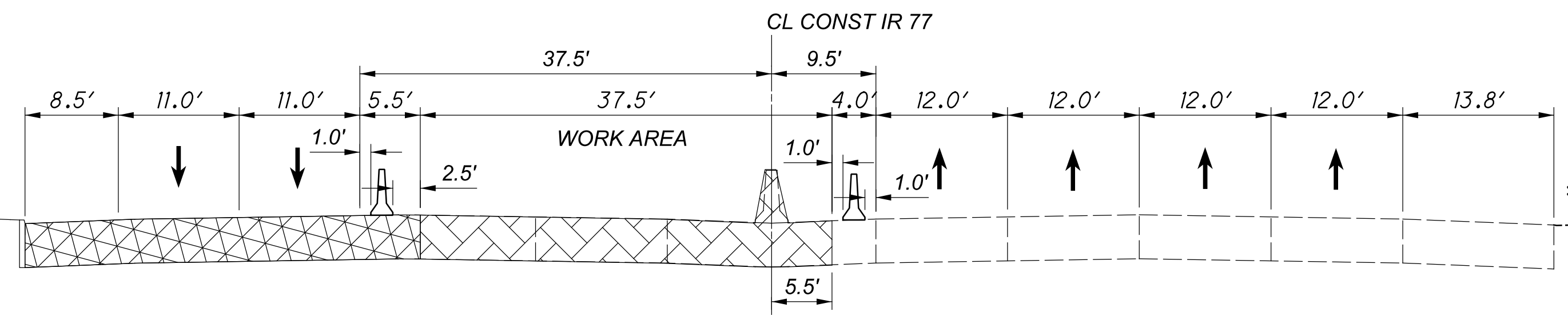

PHASE 3B
 SECTION X-X
 IR 76
 STA 513+00

Released for Construction
 Thomas J Powell, PE
 10/04/2021

ISSUE RECORD:		
NO.	DATE	DESCRIPTION

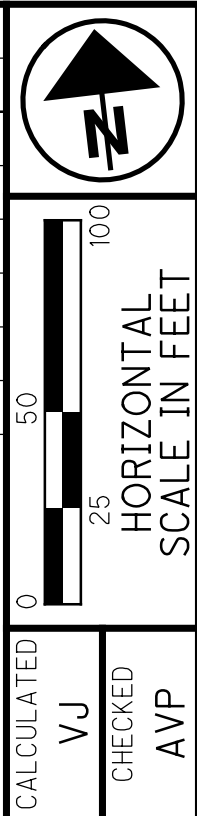

- NOTES:
1. FOR LEGEND SEE SHEET 19
 2. ALL STATIONING TAKEN FROM @ CONSTRUCTION IR 76 WB UNLESS OTHERWISE NOTED
 3. FOR DRUM SPACING SEE MT-95.40, TABLE II
 4. FOR PB FLARE RATE SEE MT-95.40, TABLE II

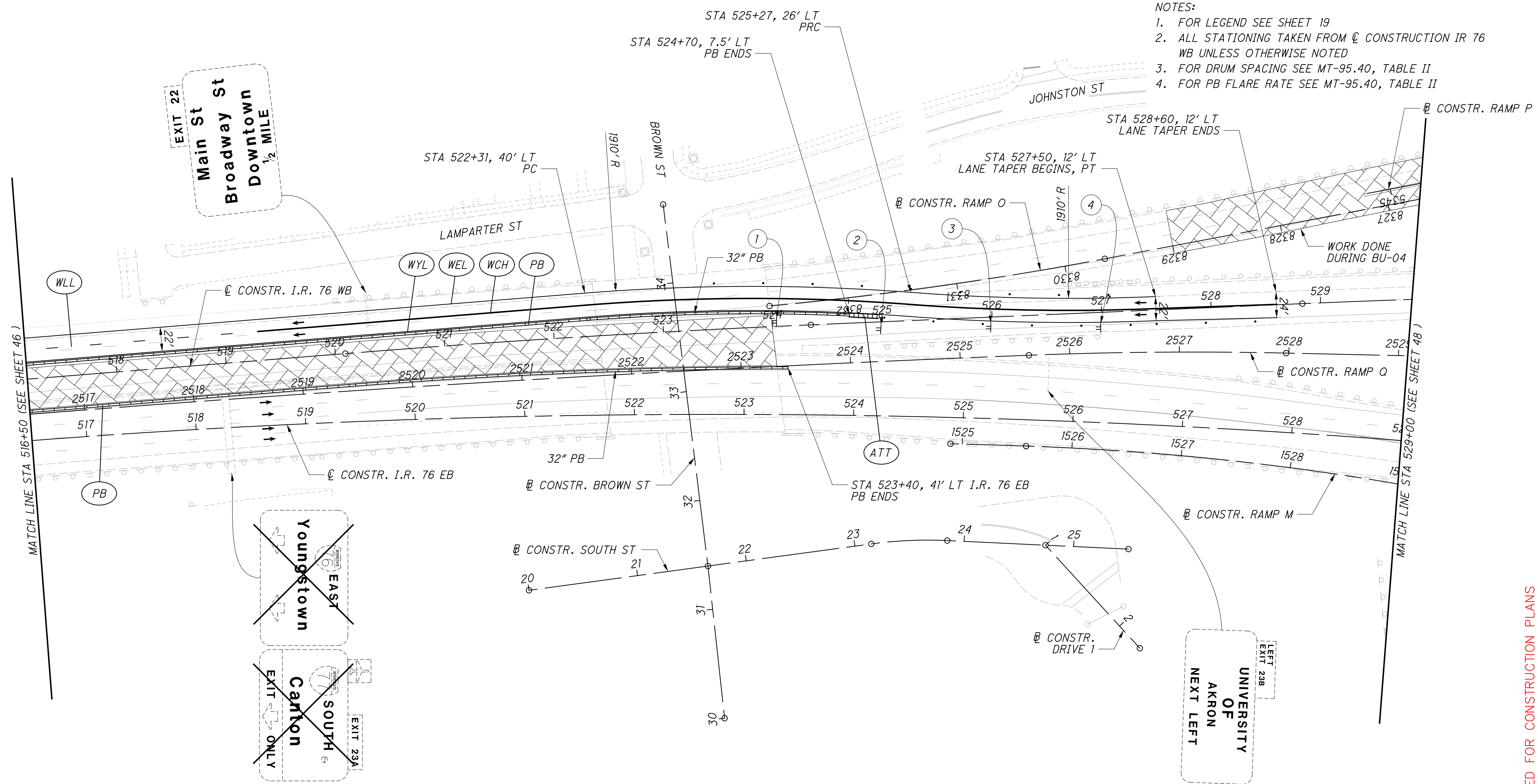

- ① STA. 524+00
- ② STA. 525+00
- ③ STA. 526+00
- ④ STA. 527+00



WI-H16-48

p:\VANVAOP\WINTO\parsons.com:Ohio State\Documents\DB-Akron Beltway Rehab\0 - Design\02329\M0T\Sheets\BU-05\02329_MPBUS220.dgn Sheet 9/28/2021 10:23 PM aplipchuk

2021-09-29 - BU 05 - RELEASED FOR CONSTRUCTION PLANS

SUM-76 / 77 / 8 -
 8.24 / 9.74 / 0.00

MOT IR 76 / IR 77 PHASE 3B
 STA 516+50 TO STA 529+00

47
 105

d:\va\vaopw\int\parsons.com\Ohio State\Documents\DB-Akron Beltway Rehab\0 - Design\02329\M0T\Sheets\BU-05\02329.MPB\BU521.dgn Sheet 9/28/2021 10:02:32 PM aplipchuk

Released for Construction
 Thomas J Powell, PE
 10/04/2021

ISSUE RECORD:		
NO.	DATE	DESCRIPTION

- NOTES:
- FOR LEGEND, SEE SHEET 19
 - ALL STATIONING TAKEN FROM \varnothing CONSTRUCTION IR 76 WB UNLESS OTHERWISE NOTED
 - FOR DRUM SPACING SEE MT-95.40, TABLE II
 - FOR PB FLARE RATE SEE MT-95.40, TABLE II

CALCULATED VJ
 CHECKED AVP

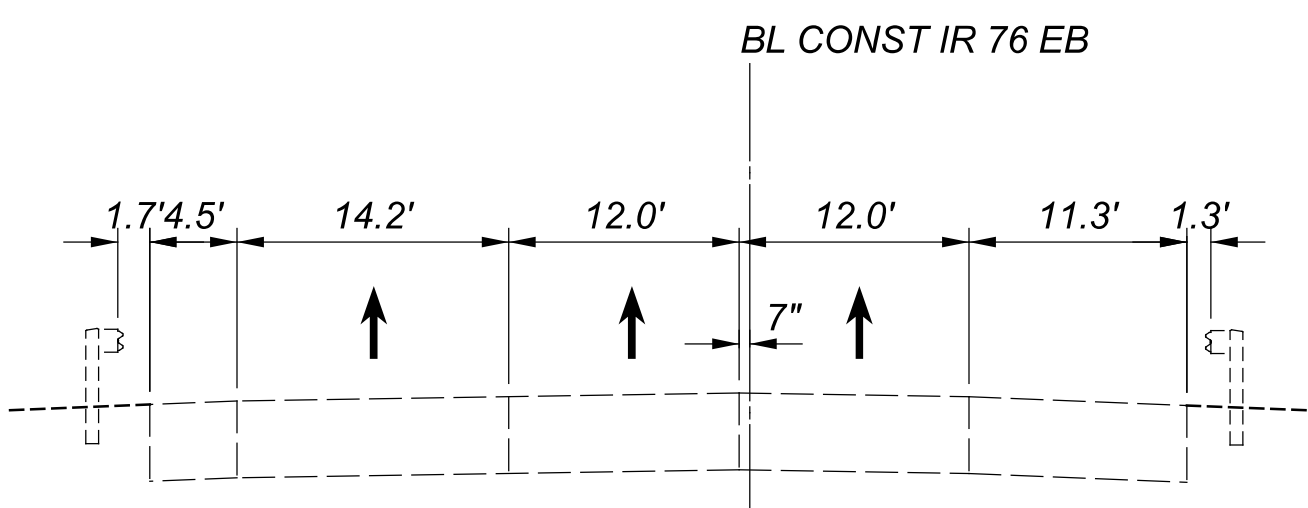
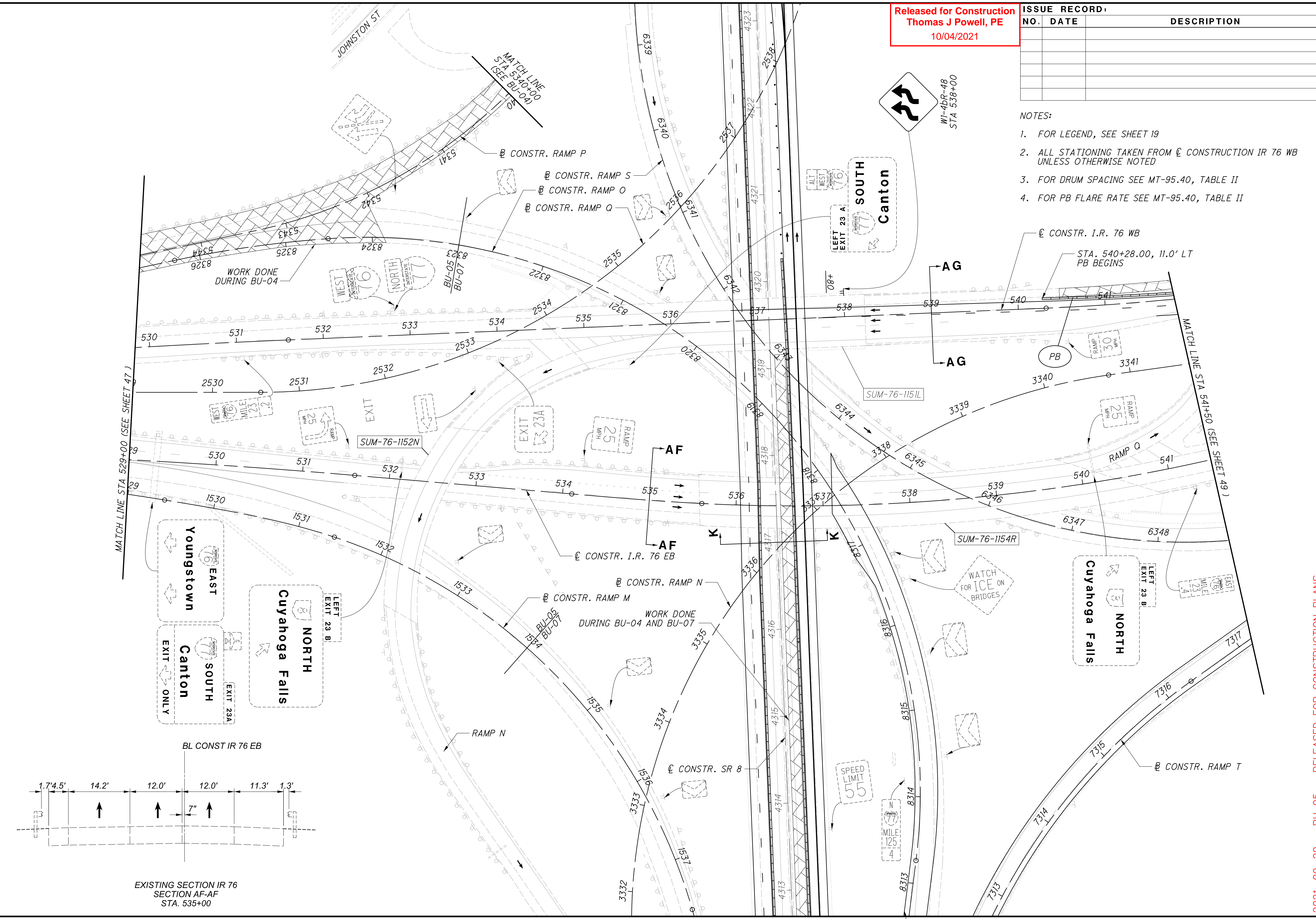

2021-09-29 - BU 05 - RELEASED FOR CONSTRUCTION PLANS

MOT IR 76 / IR 77 PHASE 3B
 STA 529+00 TO STA 541+50

SUM-76 / 77 / 8 -
 8.24 / 9.74 / 0.00

48
 105

Released for Construction
 Thomas J Powell, PE
 10/04/2021

ISSUE RECORD:		
NO.	DATE	DESCRIPTION

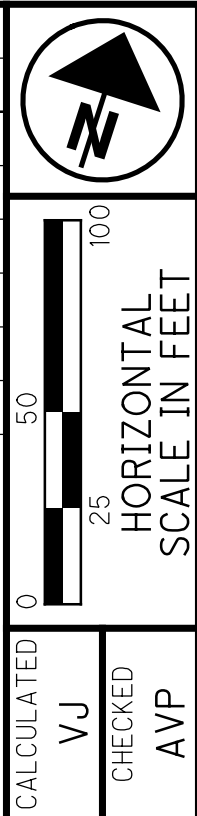

- NOTES:
- FOR LEGEND, SEE SHEET 19
 - ALL STATIONING TAKEN FROM \varnothing CONSTRUCTION IR 76 WB UNLESS OTHERWISE NOTED
 - FOR DRUM SPACING SEE MT-95.40, TABLE II
 - FOR PB FLARE RATE SEE MT-95.40, TABLE II

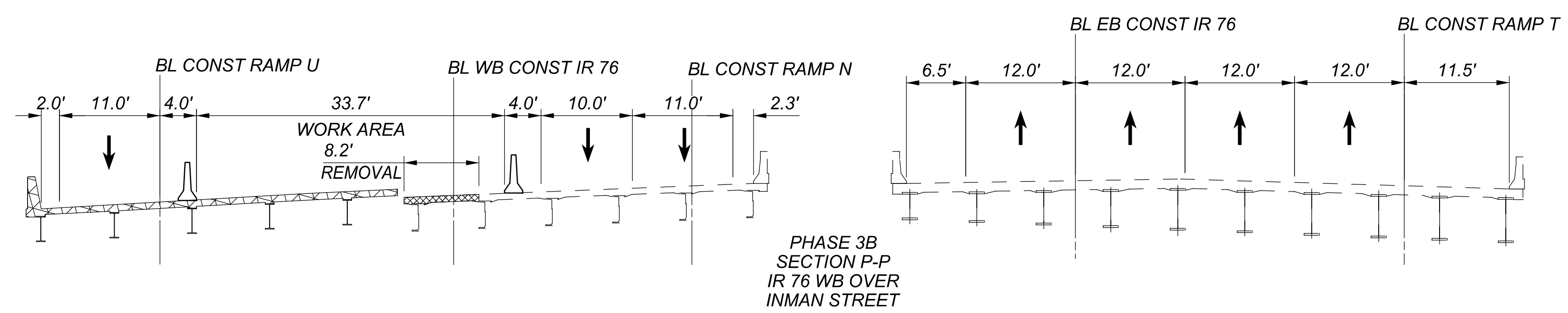
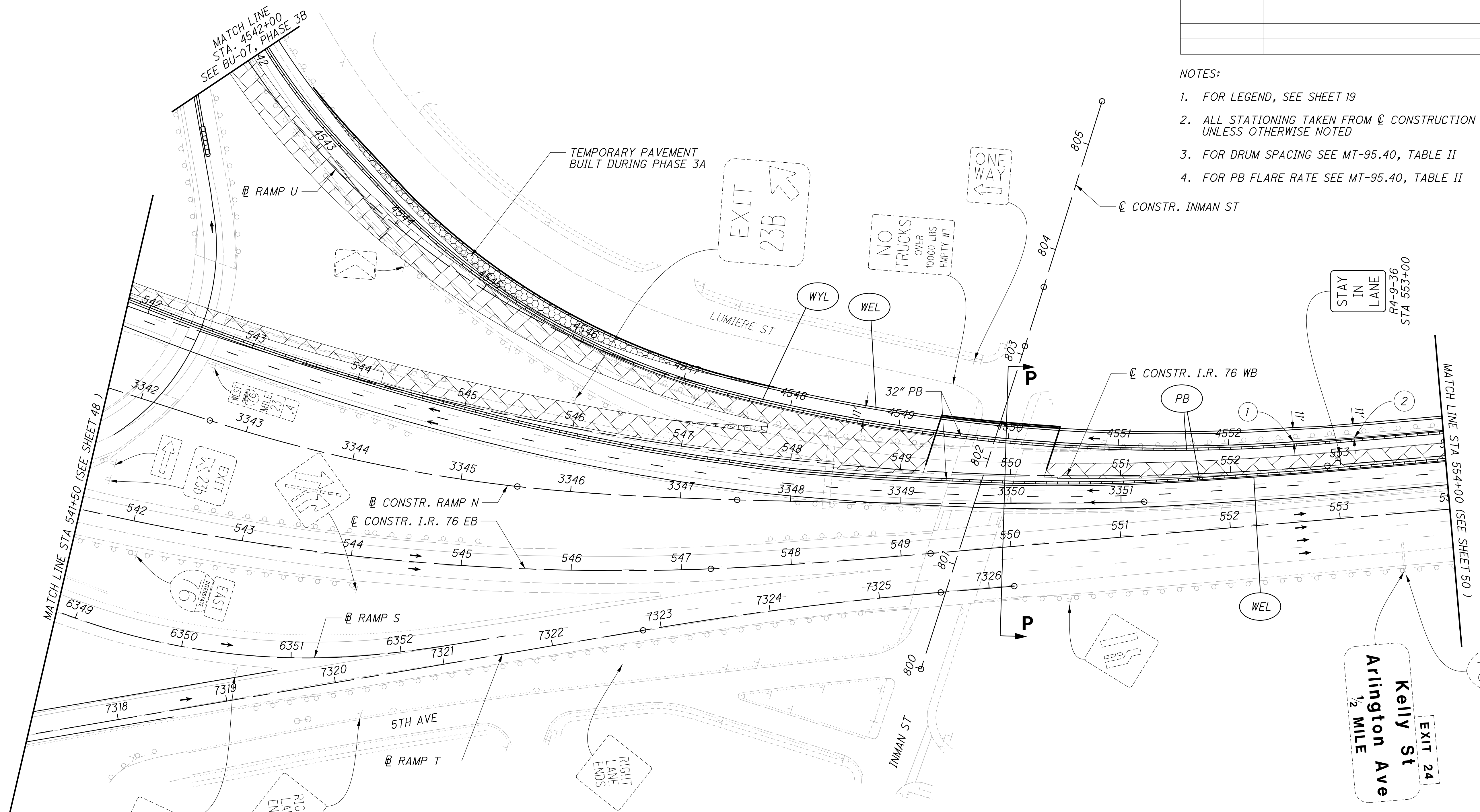

- STA. 552+59, 24.0' LT LANE SHIFT BEGINS (2' INSIDE SHOULDER)
- STA. 553+14, 23.0' RT LANE SHIFT ENDS (1' INSIDE SHOULDER)

2021-09-29 - BU 05 - RELEASED FOR CONSTRUCTION PLANS

MOT IR 76 / IR 77 PHASE 3B
 STA 541+50 TO STA 554+00

SUM-76 / 77 / 8-
 8.24 / 9.74 / 0.00

p:\VANVAO\PIWINTO\parsons.com\Ohio State\Documents\DB-Akron Beltway Rehab\10 - Design\02329\MOT\Sheets\BU-05\02329.MPB\BU5223.dgn Sheet 9/28/2021 10:24:43 PM aplipchuk

p:\VANVAOP\WINTO\parsons.com:Ohio State\Documents\DB-Akron Beltway Rehab\10 - Design\02329\M0T\Sheets\BU-05\02329.MPB\5224.dgn Sheet 9/28/2021 10:25:57 PM aplipchuk

Released for Construction
 Thomas J Powell, PE
 10/04/2021

ISSUE RECORD:		
NO.	DATE	DESCRIPTION

CALCULATED VJ
 CHECKED AVP

0 50 100
 HORIZONTAL SCALE IN FEET

- NOTES:
- FOR LEGEND, SEE SHEET 19
 - ALL STATIONING TAKEN FROM \varnothing CONSTRUCTION IR 76 WB UNLESS OTHERWISE NOTED
 - FOR DRUM SPACING SEE MT-95.40, TABLE II
 - FOR PB FLARE RATE SEE MT-95.40, TABLE II

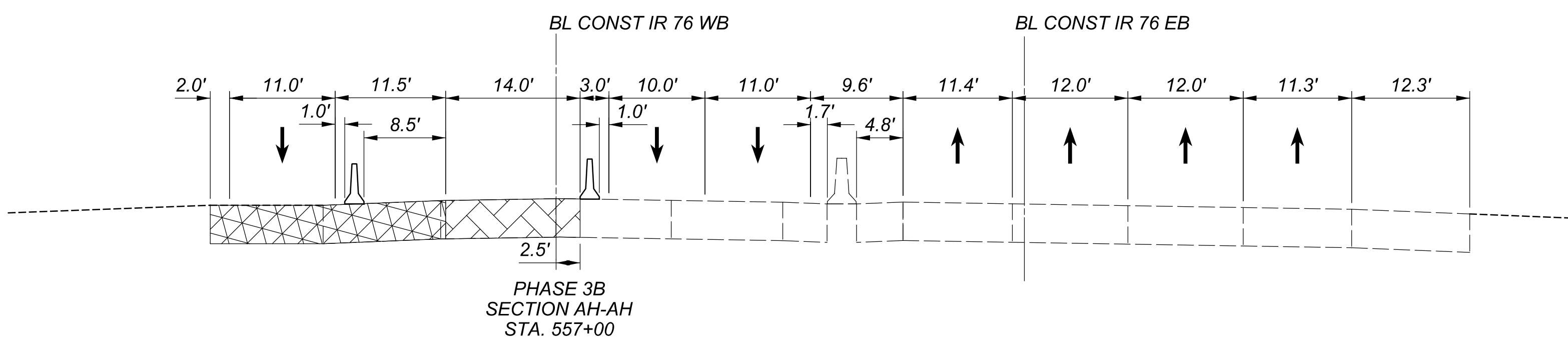
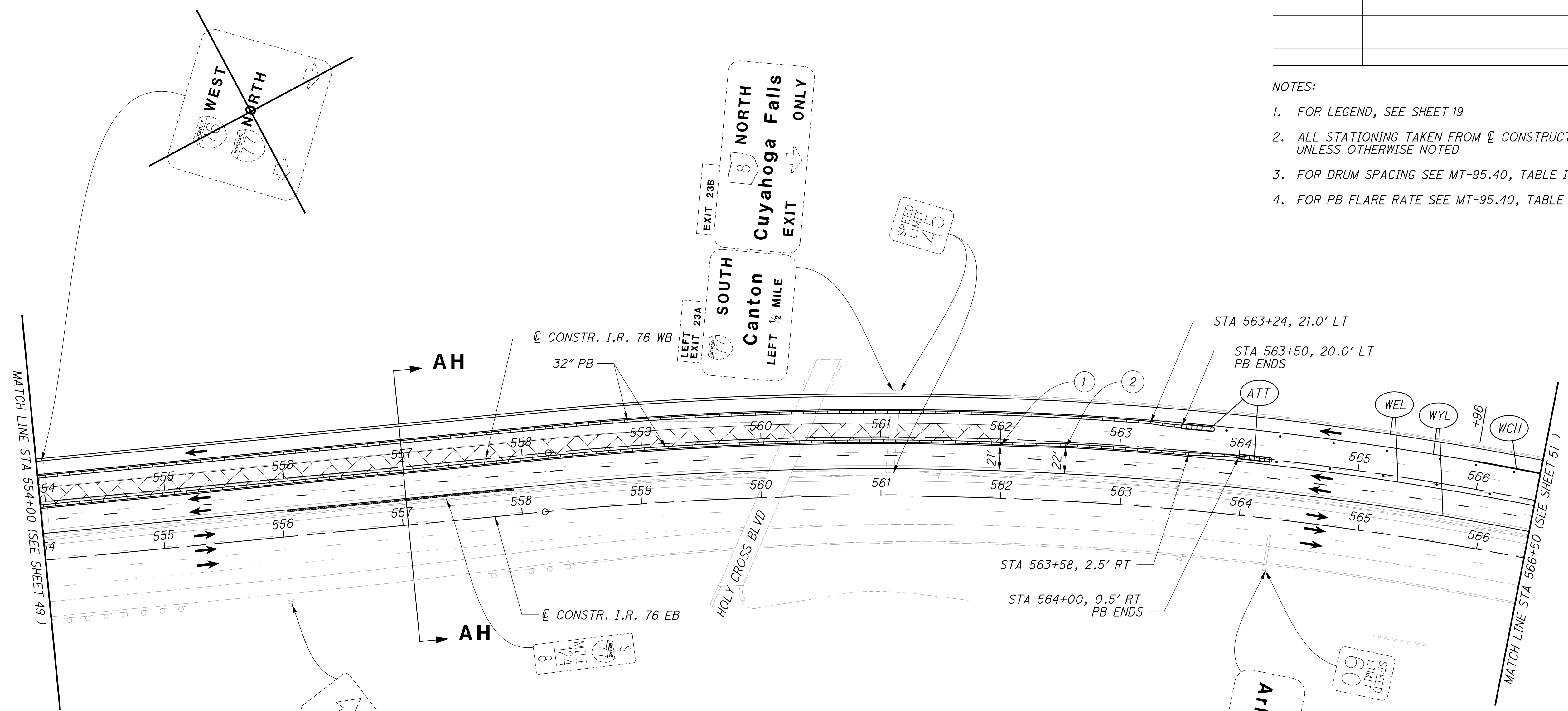

- ① — STA. 562+00, 5.5' RT LANE TAPER BEGINS
- ② — STA. 562+55, 4.5' RT LANE TAPER ENDS

2021-09-29 - BU 05 - RELEASED FOR CONSTRUCTION PLANS

MOT IR 76 / IR 77 PHASE 3B
 STA 554+00 TO STA 566+50

SUM-76 / 77 / 8-
 8.24 / 9.74 / 0.00

50
 105

Released for Construction
 Thomas J Powell, PE
 10/04/2021

ISSUE RECORD:		
NO.	DATE	DESCRIPTION

- NOTES:
- FOR LEGEND SEE SHEET 19
 - ALL STATIONING TAKEN FROM \varnothing CONSTRUCTION IR 76 WB UNLESS OTHERWISE NOTED
 - FOR DRUM SPACING SEE MT-95.40, TABLE II
 - FOR PB FLARE RATE SEE MT-95.40, TABLE II

CALCULATED VJ CHECKED AVP

0 50 100
 25
 HORIZONTAL SCALE IN FEET

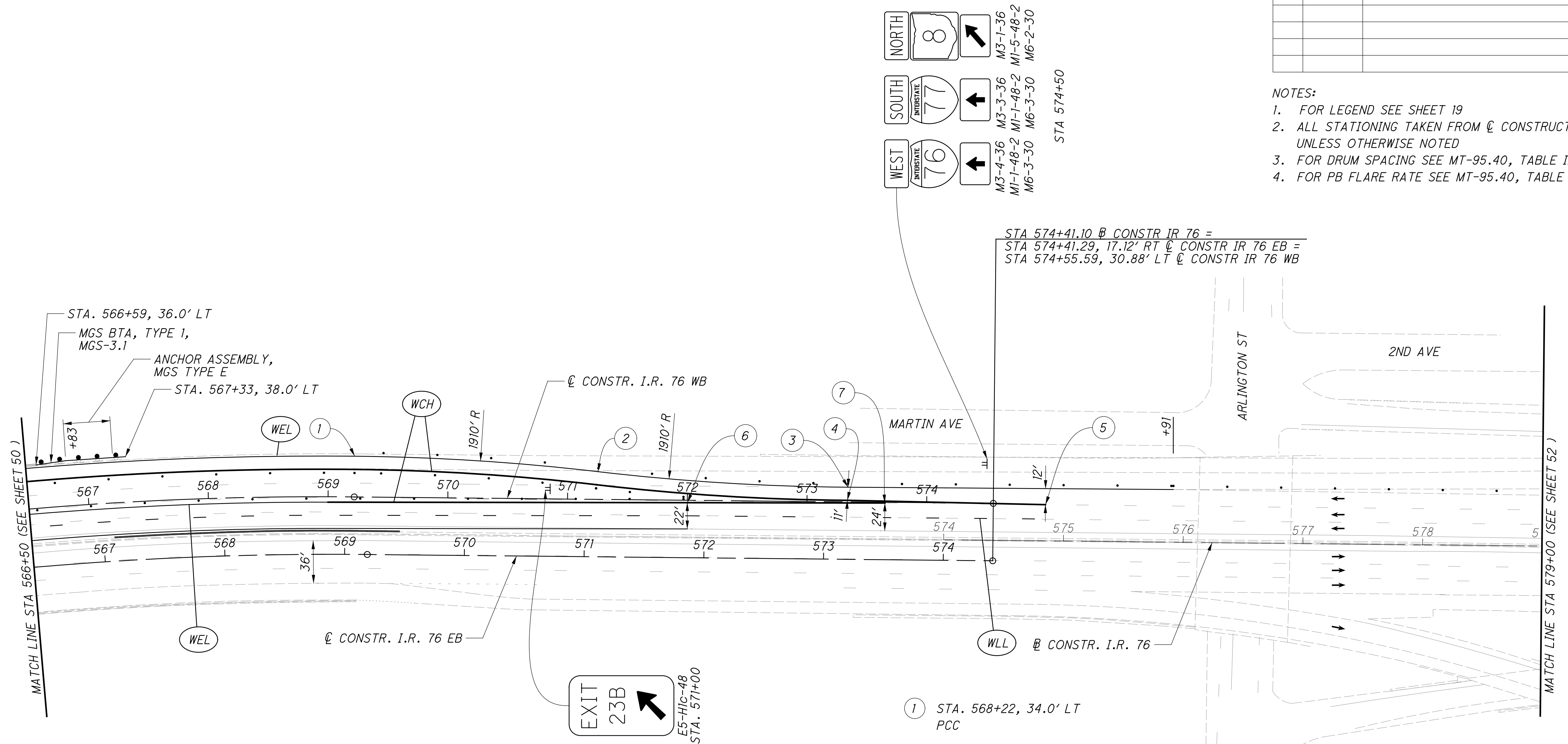

p:\va\p\w\int\parsons.com\Ohio State\Documents\DB-Akron Beltway Rehab\10 - Design\02329\M0T\Sheets\BU-05\02329_MPBUS226.dgn Sheet 9/28/2021 10:3:23 PM aplipchuk

Released for Construction
 Thomas J Powell, PE
 10/04/2021

ISSUE RECORD:		
NO.	DATE	DESCRIPTION

- NOTES:
- FOR LEGEND, SEE SHEET 19
 - ALL STATIONING TAKEN FROM CONSTR. I.R. 76 UNLESS OTHERWISE NOTED
 - FOR DRUM SPACING SEE MT-95.40, TABLE II
 - FOR PB FLARE RATE SEE MT-95.40, TABLE II

CALCULATED VJ CHECKED AVP

 HORIZONTAL SCALE IN FEET

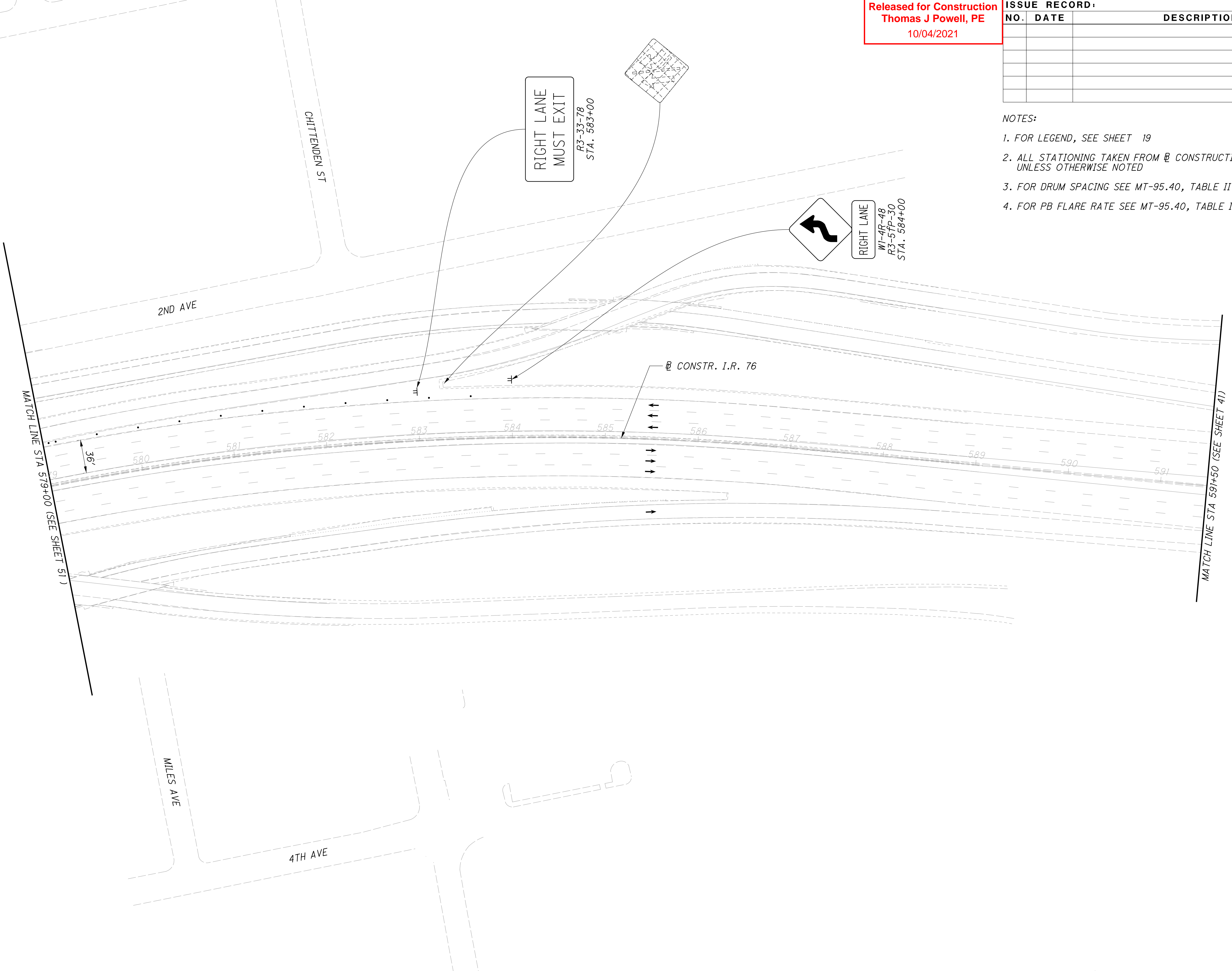

2021-09-29 - BU 05 - RELEASED FOR CONSTRUCTION PLANS

SUM-76 / 77 / 8-
 8.24 / 9.74 / 0.00

MOT IR 76 / IR 77 PHASE 3B
 STA 579+00 TO STA 591+50

pw:\VANVA01PWINT01.parsons.com:Ohio_State\Documents\B-Akron Beltway Rehab\10 - Design\102329\MOT\Sheets\BU-05\102329_MPBUS308.dgn Sheet 9/28/2021 1:03:34 PM apilipchuk

Released for Construction
 Thomas J Powell, PE
 10/04/2021

ISSUE RECORD:		
NO.	DATE	DESCRIPTION

- NOTES:
- FOR LEGEND, SEE SHEET 19
 - ALL STATIONING TAKEN FROM \varnothing CONSTRUCTION IR 76/IR 77 UNLESS OTHERWISE NOTED
 - FOR DRUM SPACING SEE MT-95.40, TABLE II
 - FOR PB FLARE RATE SEE MT-95.40, TABLE II

CALCULATED VJ CHECKED AVP

0 50 100
 25
 HORIZONTAL SCALE IN FEET

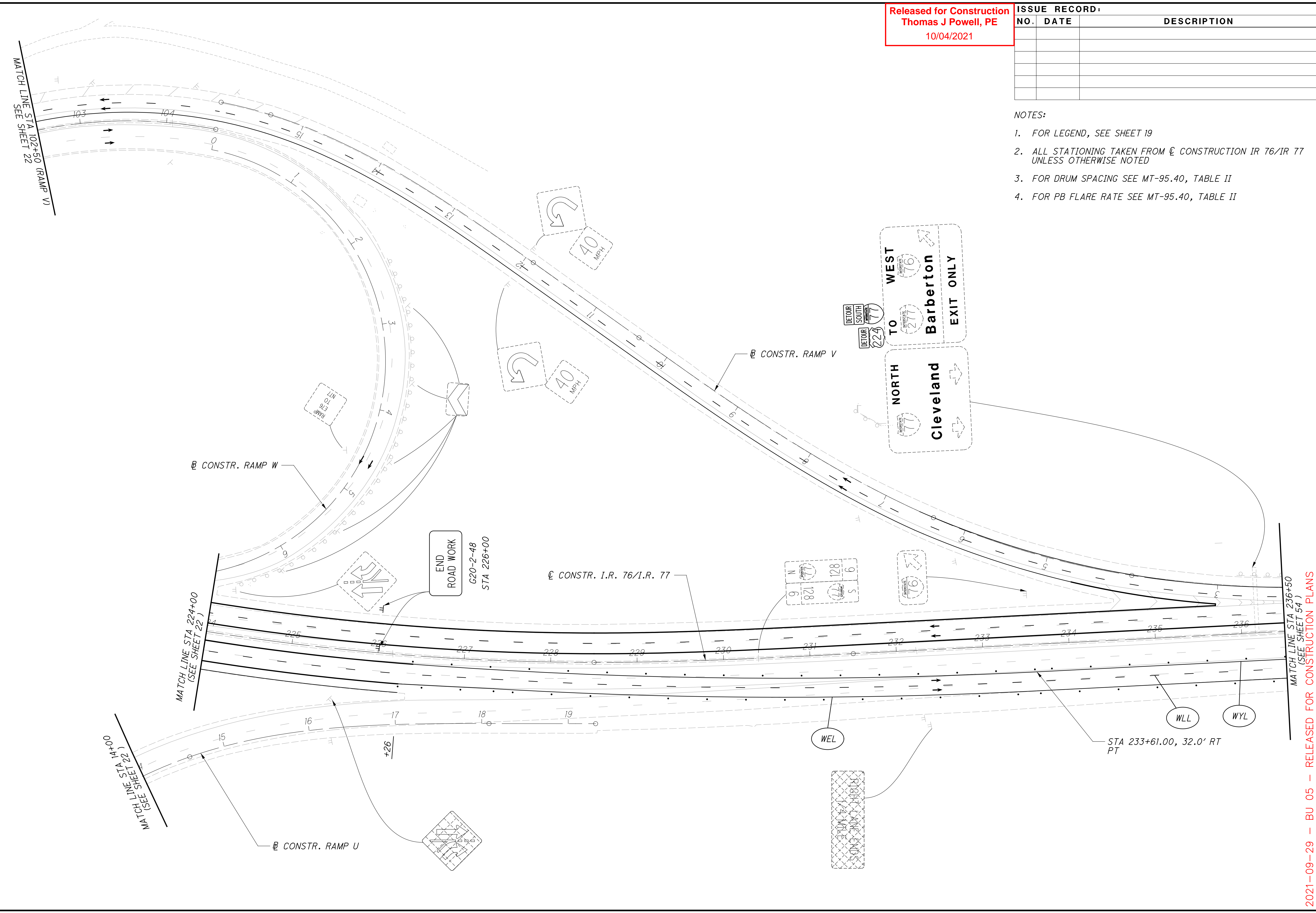

2021-09-29 - BU 05 - RELEASED FOR CONSTRUCTION PLANS

MOT IR 76 / IR 77 PHASE 4A
 STA 224+00 TO STA 236+50

SUM-76 / 77 / 8-
 8.24 / 9.74 / 0.00

53
 105

- NOTES:
1. FOR LEGEND SEE SHEET 19
 2. ALL STATIONING TAKEN FROM @ CONSTRUCTION IR 76/IR 77 UNLESS OTHERWISE NOTED
 3. FOR DRUM SPACING SEE MT-95.40, TABLE II
 4. FOR PB FLARE RATE SEE MT-95.40, TABLE II

Released for Construction
 Thomas J Powell, PE
 10/04/2021

ISSUE RECORD:		
NO.	DATE	DESCRIPTION

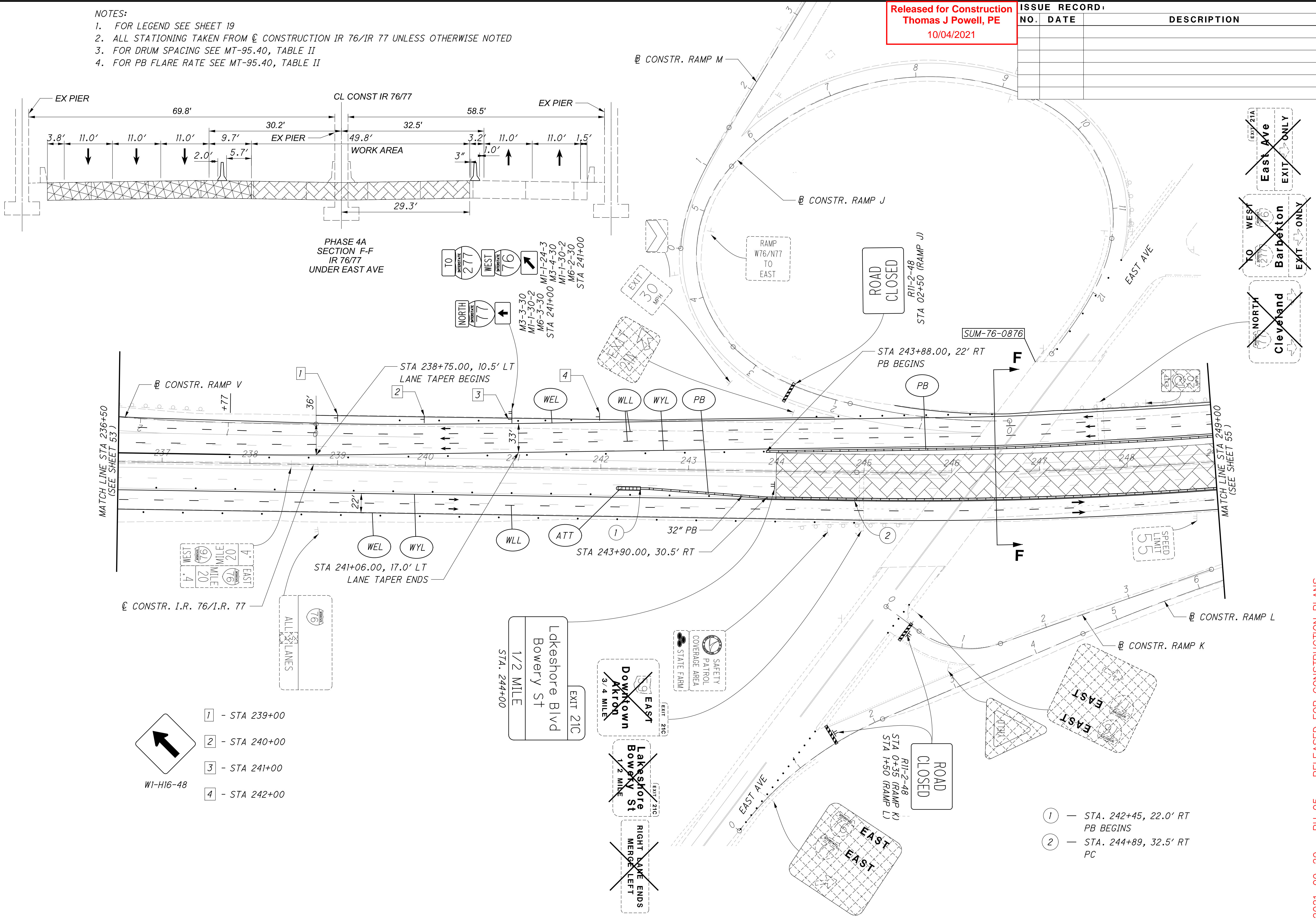
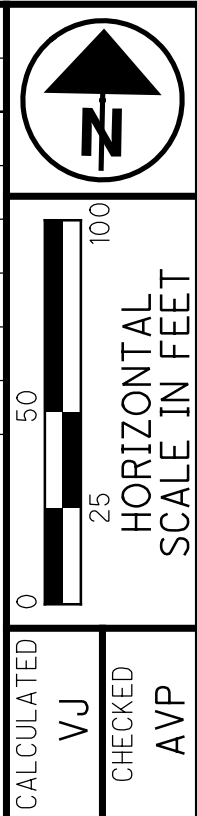

- WI-H16-48
- 1 - STA 239+00
 - 2 - STA 240+00
 - 3 - STA 241+00
 - 4 - STA 242+00

- 1 - STA. 242+45, 22.0' RT PB BEGINS
- 2 - STA. 244+89, 32.5' RT PC

2021-09-29 - BU 05 - RELEASED FOR CONSTRUCTION PLANS

MOT IR 76 / IR 77 PHASE 4A
 STA 236+50 TO STA 249+00

SUM-76 / 77 / 8-
 8.24 / 9.74 / 0.00

pw:\VANVA01PWINT01\parsons.com:Ohio State Documents\DB-Akron Beltway Rehab\10 - Design\102329\MOT\Sheets\BU-05\102329_MPBUS309.dgn Sheet 9/28/2021 1:03:54 PM aplipchuk

p:\ANV\A01P\WINT01\parsons.com\Ohio_State\Documents\DB-Akron Beltway Rehab\10 - Design\102329\MOT\Sheets\BU-05\102329_MPB\BU5310.dgn Sheet 9/28/2021 1:04:10 PM aplipchuk

Released for Construction
 Thomas J Powell, PE
 10/04/2021

ISSUE RECORD:		
NO.	DATE	DESCRIPTION

CALCULATED VJ CHECKED AVP

0 50 100
 25
 HORIZONTAL SCALE IN FEET

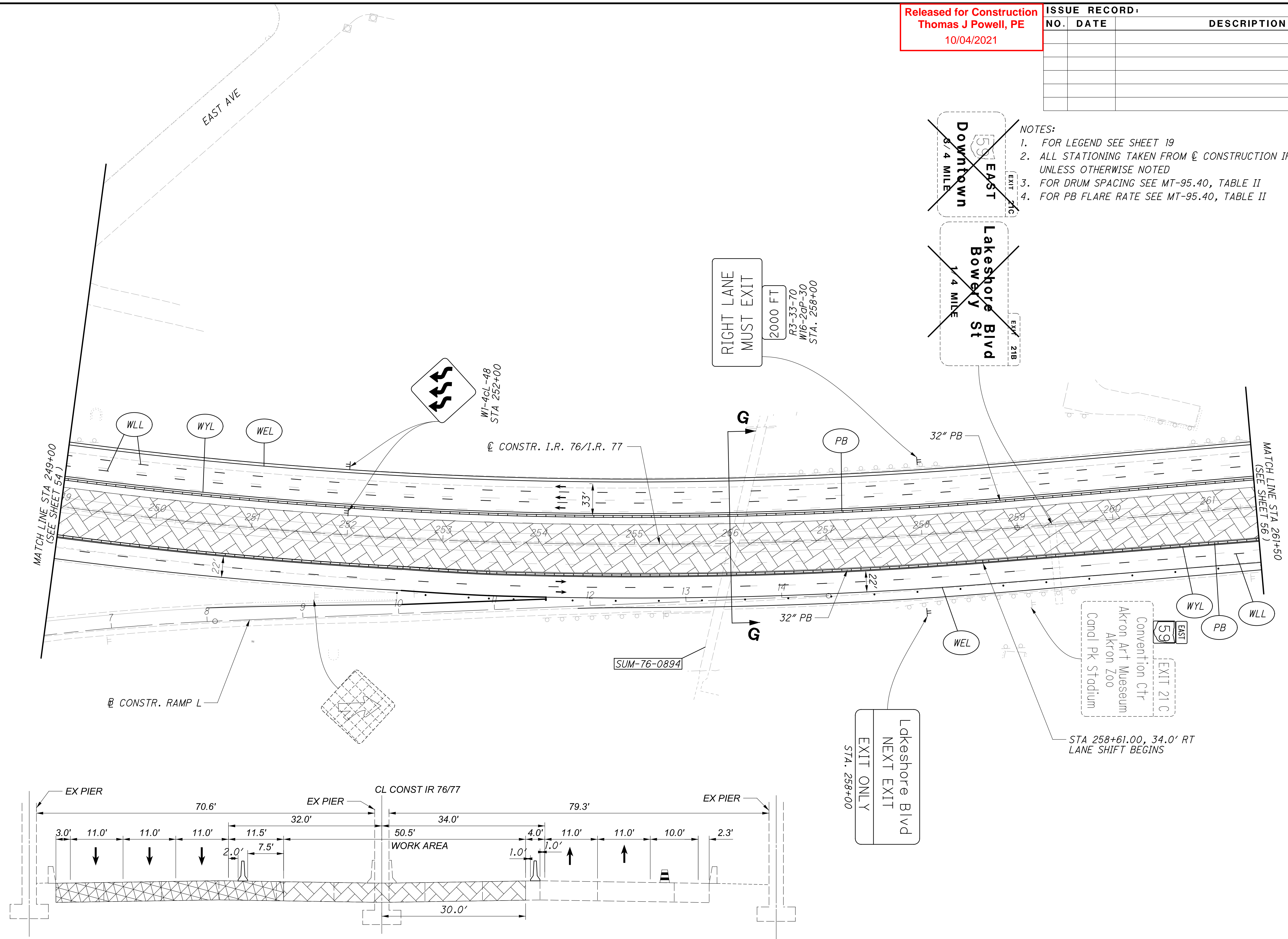

- NOTES:
- FOR LEGEND SEE SHEET 19
 - ALL STATIONING TAKEN FROM \odot CONSTRUCTION IR 76/IR 77 UNLESS OTHERWISE NOTED
 - FOR DRUM SPACING SEE MT-95.40, TABLE II
 - FOR PB FLARE RATE SEE MT-95.40, TABLE II

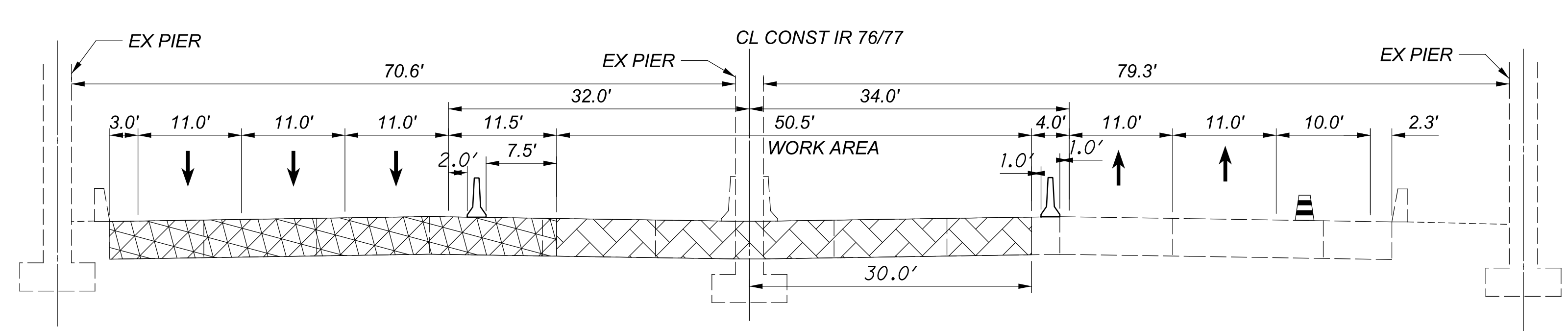

PHASE 4A
 SECTION G-G
 IR 76/77
 UNDER HILLCREST PEDESTRIAN BRIDGE

2021-09-29 - BU 05 - RELEASED FOR CONSTRUCTION PLANS

MOT IR 76 / IR 77 PHASE 4A
 STA. 249+00 TO STA 261+50

SUM-76 / 77 / 8 -
 8.24 / 9.74 / 0.00

55
 105

pw:\VANVAOP\WINTO\parsons.com:Ohio State\Documents\DB-Akron Beltway Rehab\10 - Design\02329\MOT\Sheets\BU-05\02329.MPB\53\l.dgn Sheet 9/28/2021 10:42:3 PM apilipchuk

Released for Construction
 Thomas J Powell, PE
 10/04/2021

ISSUE RECORD:		
NO.	DATE	DESCRIPTION

- NOTES:
- FOR LEGEND SEE SHEET 19
 - ALL STATIONING TAKEN FROM CL CONSTRUCTION IR 76/IR 77 UNLESS OTHERWISE NOTED
 - FOR DRUM SPACING SEE MT-95.40, TABLE II
 - FOR PB FLARE RATE SEE MT-95.40, TABLE II

CALCULATED
 VJ
 CHECKED
 AVP

0 50 100
 HORIZONTAL
 SCALE IN FEET

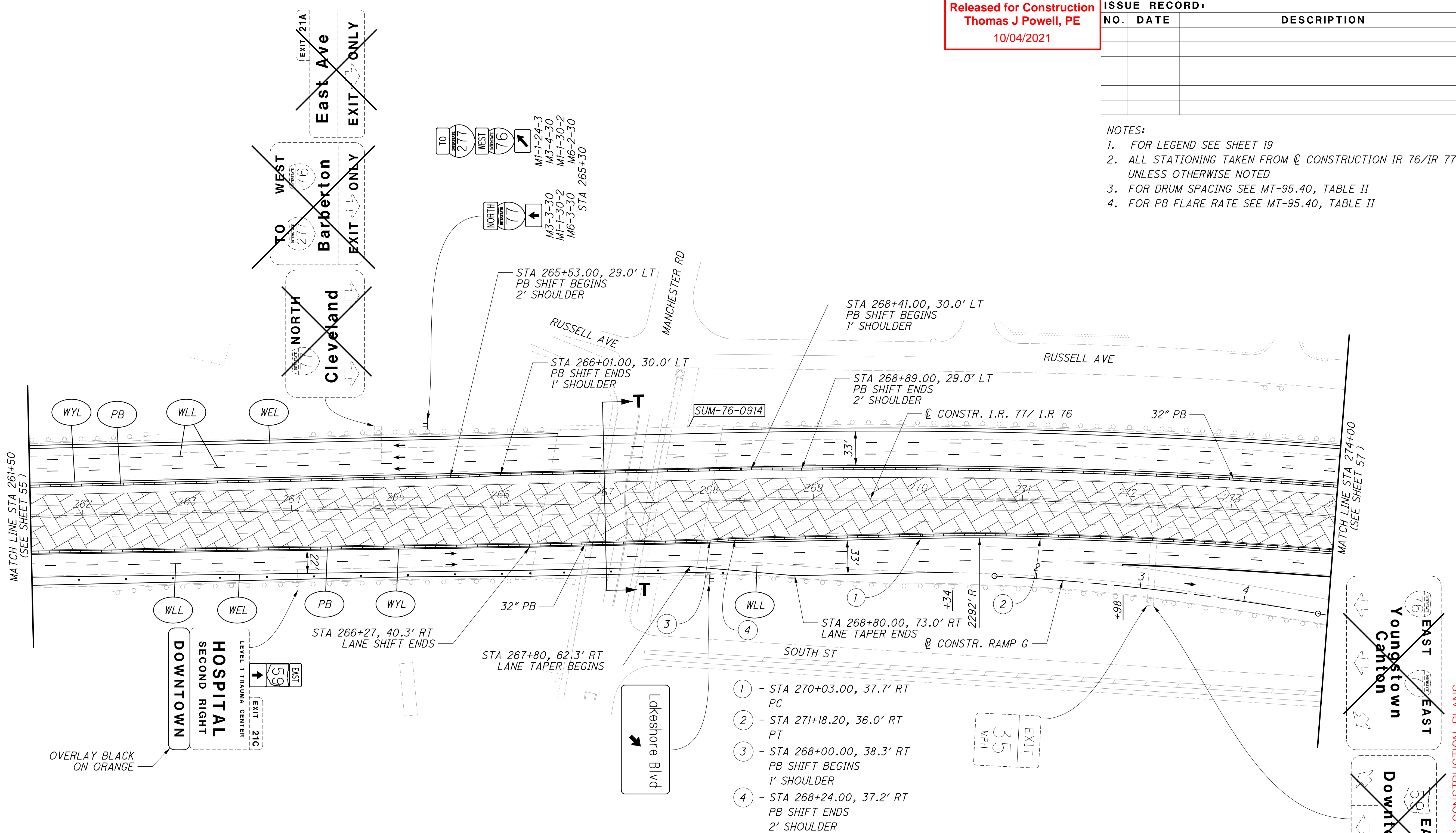

- 1 - STA 270+03.00, 37.7' RT PC
- 2 - STA 271+18.20, 36.0' RT PT
- 3 - STA 268+00.00, 38.3' RT PB SHIFT BEGINS 1' SHOULDER
- 4 - STA 268+24.00, 37.2' RT PB SHIFT ENDS 2' SHOULDER

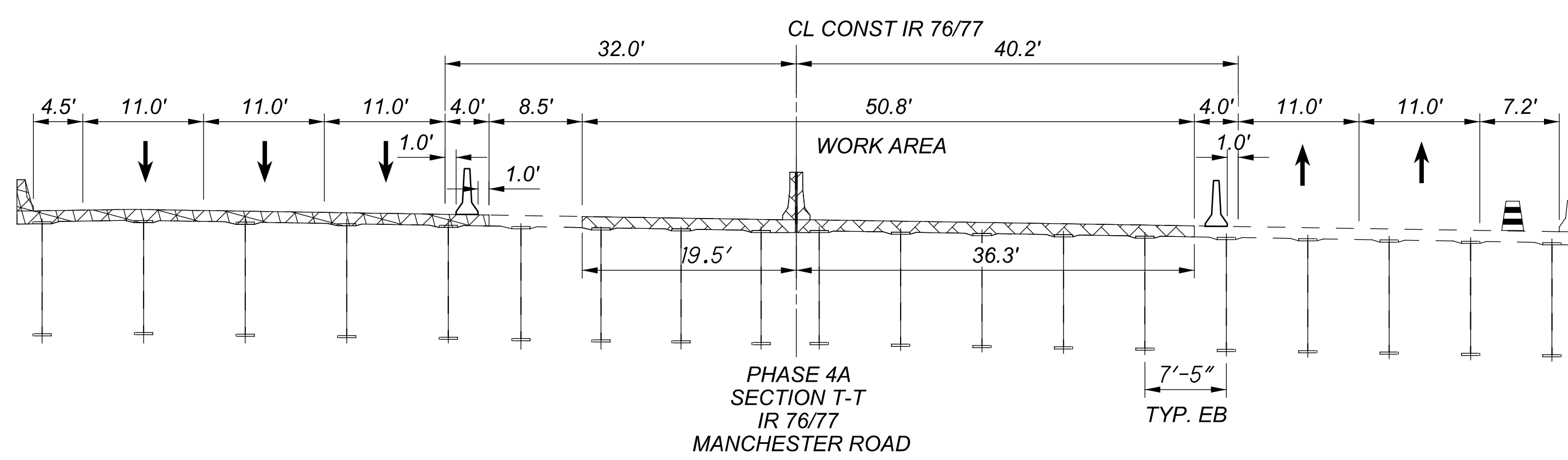

2021-09-29 - BU 05 - RELEASED FOR CONSTRUCTION PLANS

MOT IR 76 / IR 77 PHASE 4A
SUM-76 / 77 / 8-
8.24 / 9.74 / 0.00

STA 261+50 TO STA 274+00

pw:\VANVAOPWINTO\parsons.com:Ohio State\Documents\B-Akron Beltway Rehab\0 - Design\02329\MOT\Sheets\BU-05\02329_MPBUS312.dgn_Sheet 9/28/2021 10:43:34 PM aplipchuk

Released for Construction
 Thomas J Powell, PE
 10/04/2021

ISSUE RECORD:		
NO.	DATE	DESCRIPTION

- NOTES:
- FOR LEGEND SEE SHEET 19
 - ALL STATIONING TAKEN FROM \odot CONSTRUCTION IR 76/IR 77 UNLESS OTHERWISE NOTED
 - FOR DRUM SPACING SEE MT-95.40, TABLE II
 - FOR PB FLARE RATE SEE MT-95.40, TABLE II

CALCULATED VJ CHECKED AVP

0 50 100
 25
 HORIZONTAL SCALE IN FEET

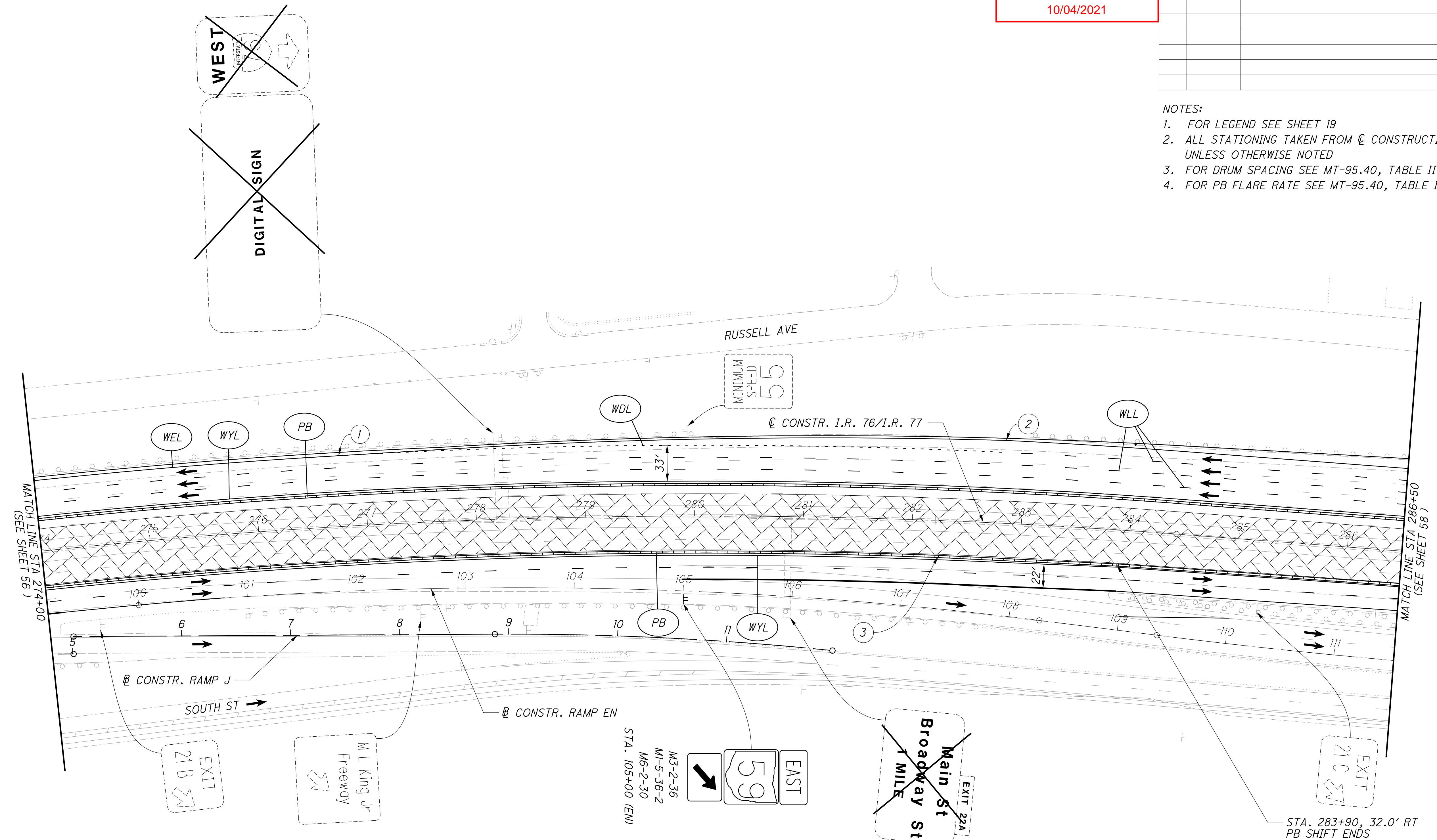

- ① — STA. 276+77, 65.0' LT LANE TAPER BEGINS
- ② — STA. 282+83, 76.0' LT LANE TAPER ENDS
- ③ — STA. 282+25, 33.0' RT PB SHIFT BEGINS 2' SHOULDER

2021-09-29 - BU 05 - RELEASED FOR CONSTRUCTION PLANS

MOT IR 76 / IR 77 PHASE 4A
 STA 274+00 TO STA 286+50

SUM-76 / 77 / 8-
 8.24 / 9.74 / 0.00

d:\va\p\w\int\ol\parsons.com\Ohio State\Documents\DB-Akron Beltway Rehab\10 - Design\02329\MOT_Sheets\BU-05\02329_MPB\5313.dgn Sheet 9/28/2021 10:44:46 PM aplipchuk

Released for Construction
 Thomas J Powell, PE
 10/04/2021

ISSUE RECORD:		
NO.	DATE	DESCRIPTION

NOTES:

- FOR LEGEND SEE SHEET 19
- ALL STATIONING TAKEN FROM \varnothing CONSTRUCTION IR 76/IR 77 UNLESS OTHERWISE NOTED
- FOR DRUM SPACING SEE MT-95.40, TABLE II
- FOR PB FLARE RATE SEE MT-95.40, TABLE II

0 50 100
 HORIZONTAL SCALE IN FEET
 CALCULATED VJ
 CHECKED AVP

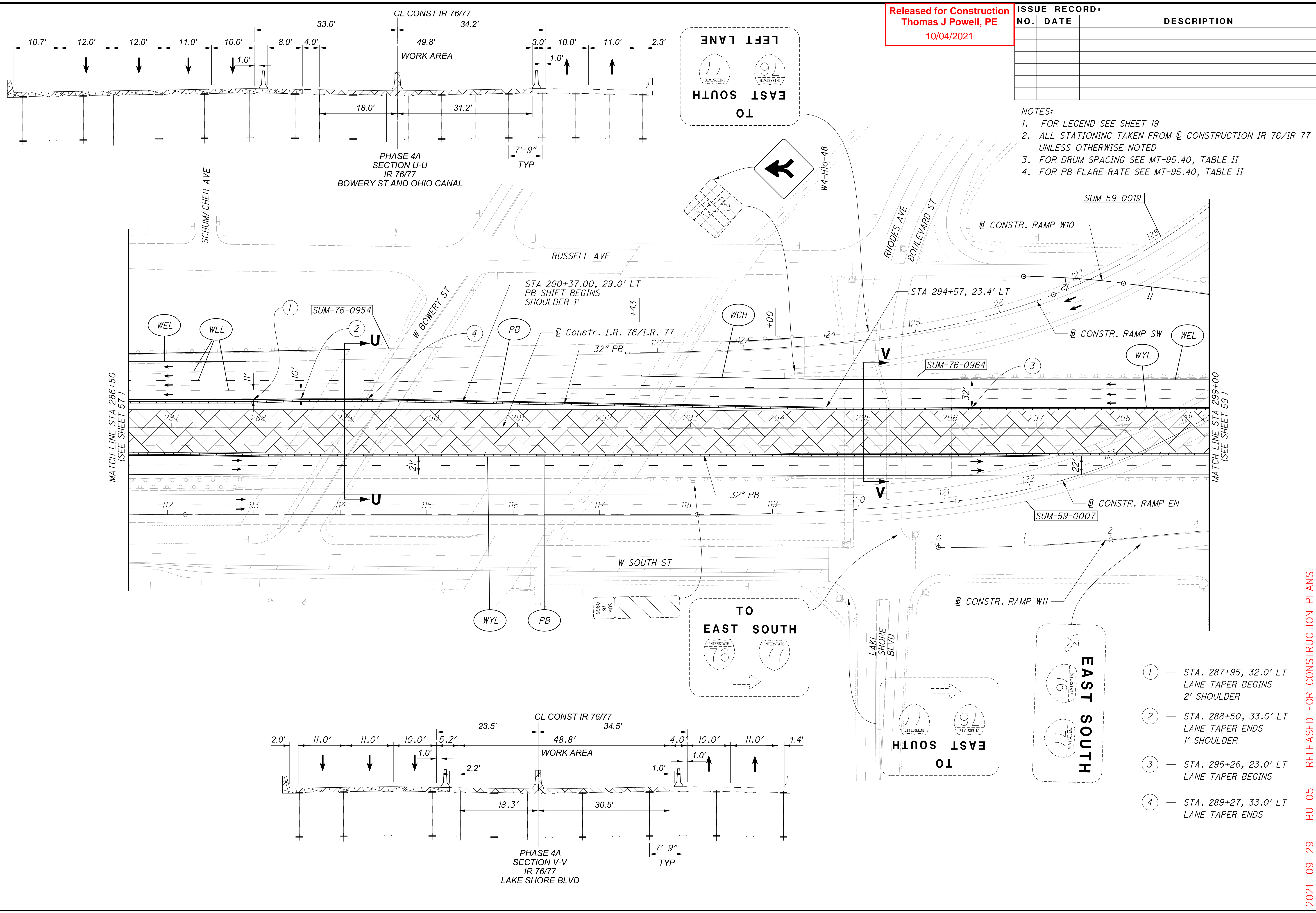

- ① — STA. 287+95, 32.0' LT LANE TAPER BEGINS 2' SHOULDER
- ② — STA. 288+50, 33.0' LT LANE TAPER ENDS 1' SHOULDER
- ③ — STA. 296+26, 23.0' LT LANE TAPER BEGINS
- ④ — STA. 289+27, 33.0' LT LANE TAPER ENDS

2021-09-29 - BU 05 - RELEASED FOR CONSTRUCTION PLANS

MOT IR 76 / IR 77 PHASE 4A
SUM-76/77/8-
STA 286+50 TO STA 299+00
8.24/9.74/0.00

p:\va\vaipwintol\parsons.com\Ohio State\Documents\DB-Akron Beltway Rehab\0 - Design\02329\M0T\Sheets\BU-05\02329.MPB\05314.dgn Sheet 9/28/2021 10:45:56 PM aplipchuk

Released for Construction
 Thomas J Powell, PE
 10/04/2021

ISSUE RECORD:		
NO.	DATE	DESCRIPTION

- NOTES:
- FOR LEGEND SEE SHEET 19
 - ALL STATIONING TAKEN FROM @ CONSTRUCTION IR 76/IR 77 UNLESS OTHERWISE NOTED
 - FOR DRUM SPACING SEE MT-95.40, TABLE II
 - FOR PB FLARE RATE SEE MT-95.40, TABLE II

CALCULATED VJ
 CHECKED AVP

HORIZONTAL SCALE IN FEET

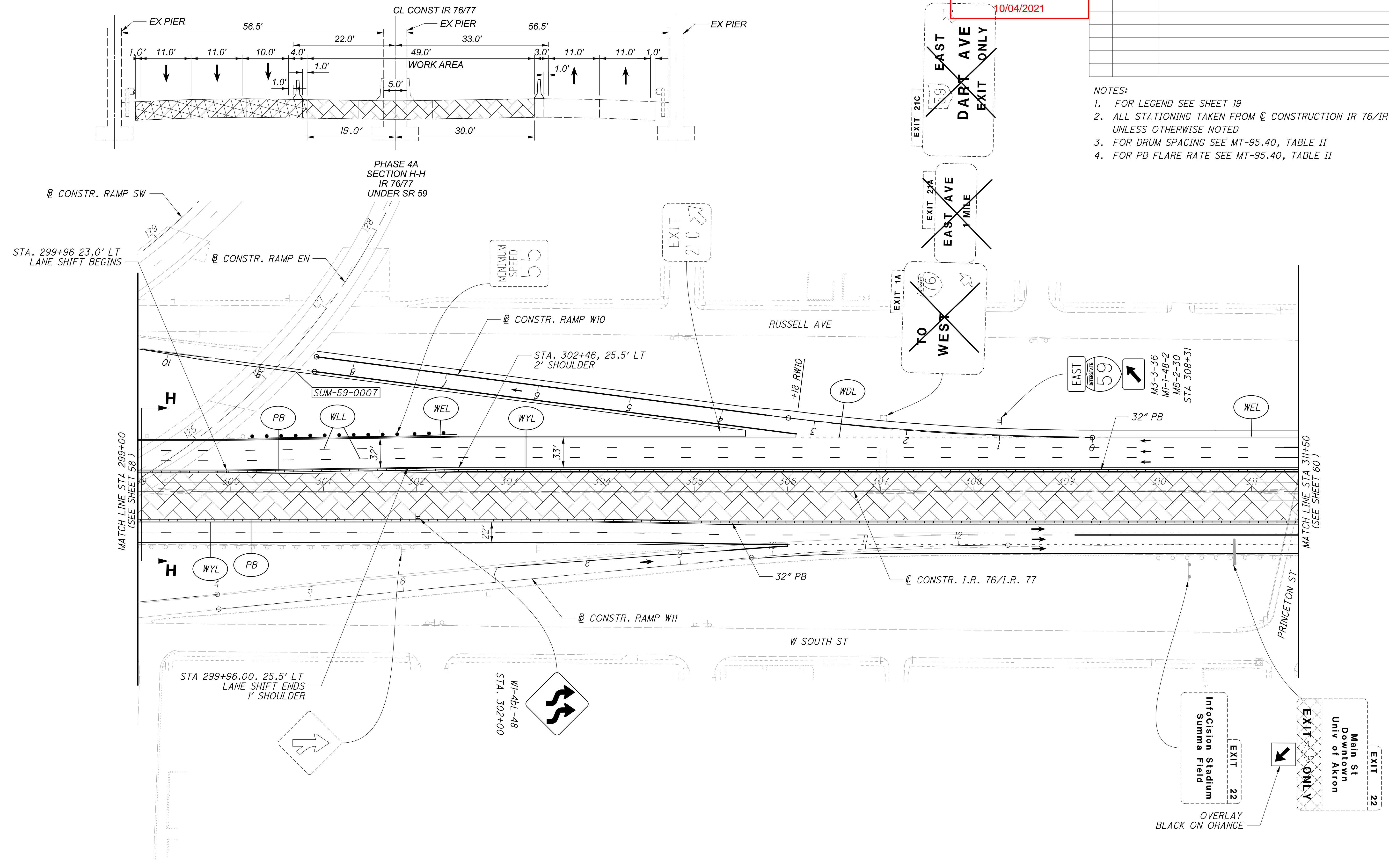

2021-09-29 - BU 05 - RELEASED FOR CONSTRUCTION PLANS

MOT IR 76 / IR 77 PHASE 4A
 STA 299+00 TO STA 311+50

SUM-76 / 77 / 8-
 8.24 / 9.74 / 0.00

59
 105

p:\VANVAOPWINTO\parsons.com\Ohio State\Documents\DB-Akron Beltway Rehab\10 - Design\02329\MOT\Sheets\BU-05\02329_MPBUS315.dgn Sheet 9/28/2021 10:05:07 PM aplipchuk

Released for Construction
 Thomas J Powell, PE
 10/04/2021

ISSUE RECORD:		
NO.	DATE	DESCRIPTION

- NOTES:
- FOR LEGEND SEE SHEET 19
 - ALL STATIONING TAKEN FROM $\text{CL CONSTRUCTION IR 76/IR 77}$ UNLESS OTHERWISE NOTED
 - FOR DRUM SPACING SEE MT-95.40, TABLE II
 - FOR PB FLARE RATE SEE MT-95.40, TABLE II

CALCULATED
VJ
CHECKED
AVP

0 50 100
 HORIZONTAL
 SCALE IN FEET

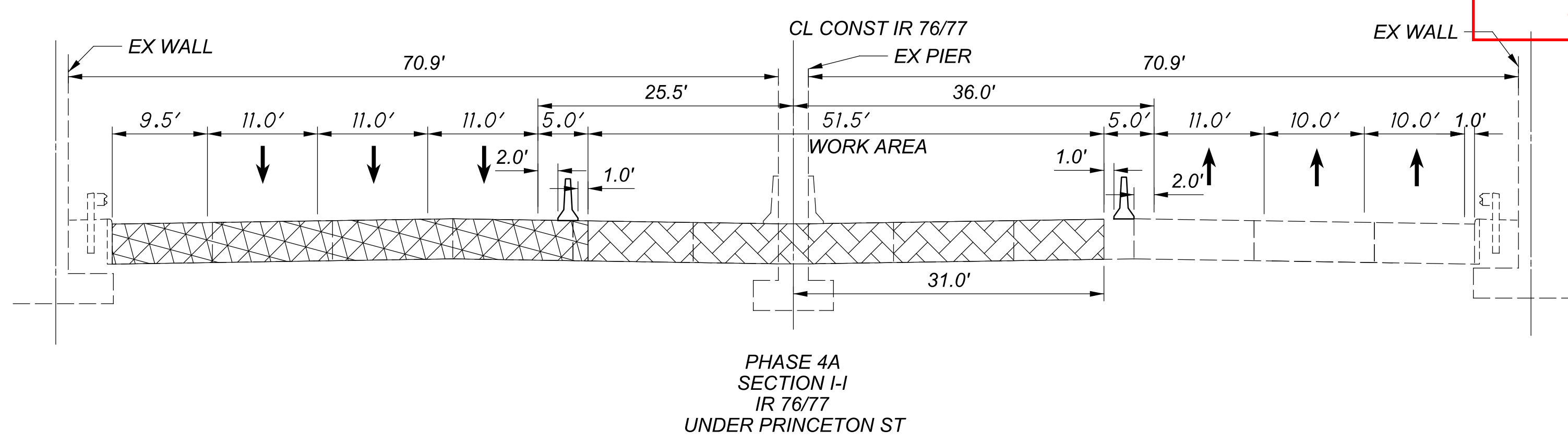

PHASE 4A
 SECTION I-I
 IR 76/77
 UNDER PRINCETON ST

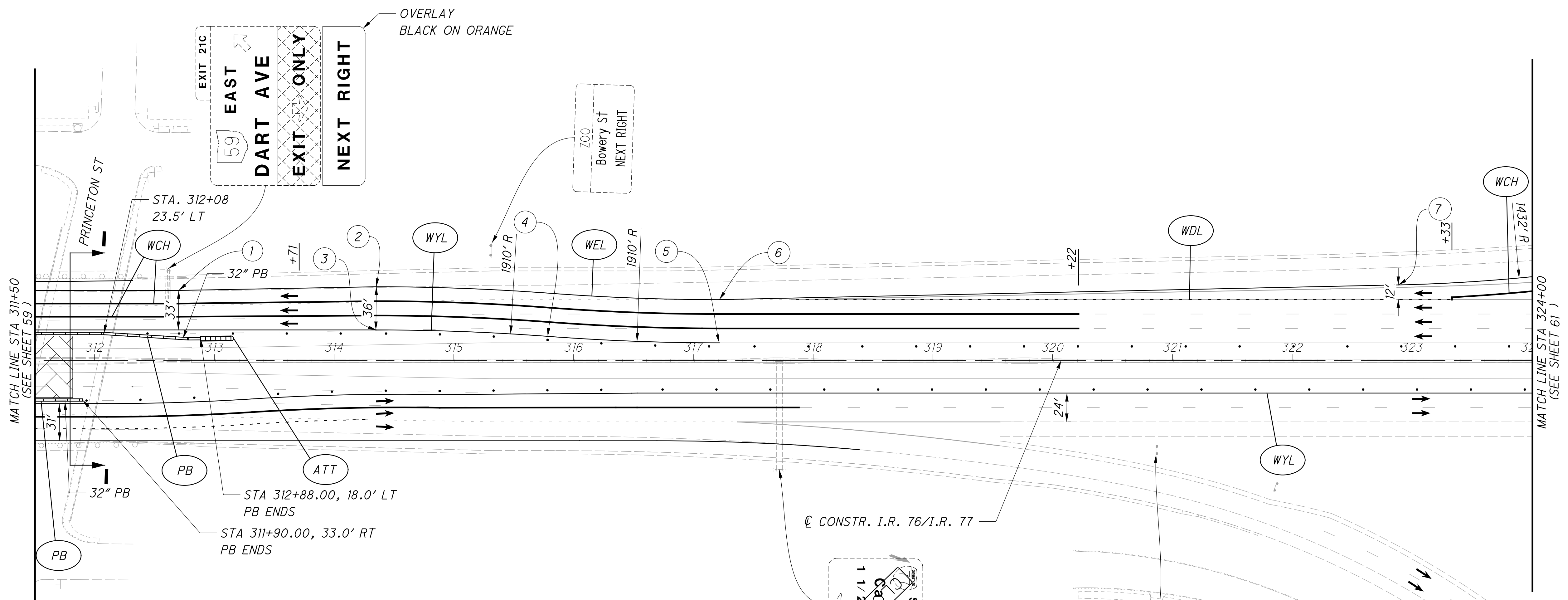

- | | |
|--|---|
| <p>① — STA. 312+70, 58.5' LT LANE TAPER BEGINS</p> <p>② — STA. 314+35, 61.5' LT LANE TAPER ENDS</p> <p>③ — STA. 314+35, 21.5' LT PC</p> <p>④ — STA. 315+78, 20.0' LT PRC</p> | <p>⑤ — STA. 317+22, 15.0' LT PT</p> <p>⑥ — STA. 317+22, 51.0' LT LANE TAPER BEGINS</p> <p>⑦ — STA. 322+89, 63.0' LT LANE TAPER ENDS</p> |
|--|---|

2021-09-29 - BU 05 - RELEASED FOR CONSTRUCTION PLANS

MOT IR 76 / IR 77 PHASE 4A
 STA 311+50 TO STA 324+00

SUM-76 / 77 / 8-
 8.24 / 9.74 / 0.00

60
 105

d:\va\vaipwintol\parsons.com\Ohio State\Documents\DB-Akron Beltway Rehab\0 - Design\02329\M0T\Sheets\BU-05\02329_MPB05316.dgn Sheet 9/28/2021 05:17 PM apilipchuk

- NOTES:
1. FOR LEGEND SEE SHEET 19
 2. ALL STATIONING TAKEN FROM C CONSTRUCTION IR 76/IR 77 UNLESS OTHERWISE NOTED
 3. FOR DRUM SPACING SEE MT-95.40, TABLE II
 4. FOR PB FLARE RATE SEE MT-95.40, TABLE II

Released for Construction
 Thomas J Powell, PE
 10/04/2021

ISSUE RECORD:		
NO.	DATE	DESCRIPTION

CALCULATED
VJ

CHECKED
AVP

HORIZONTAL SCALE IN FEET

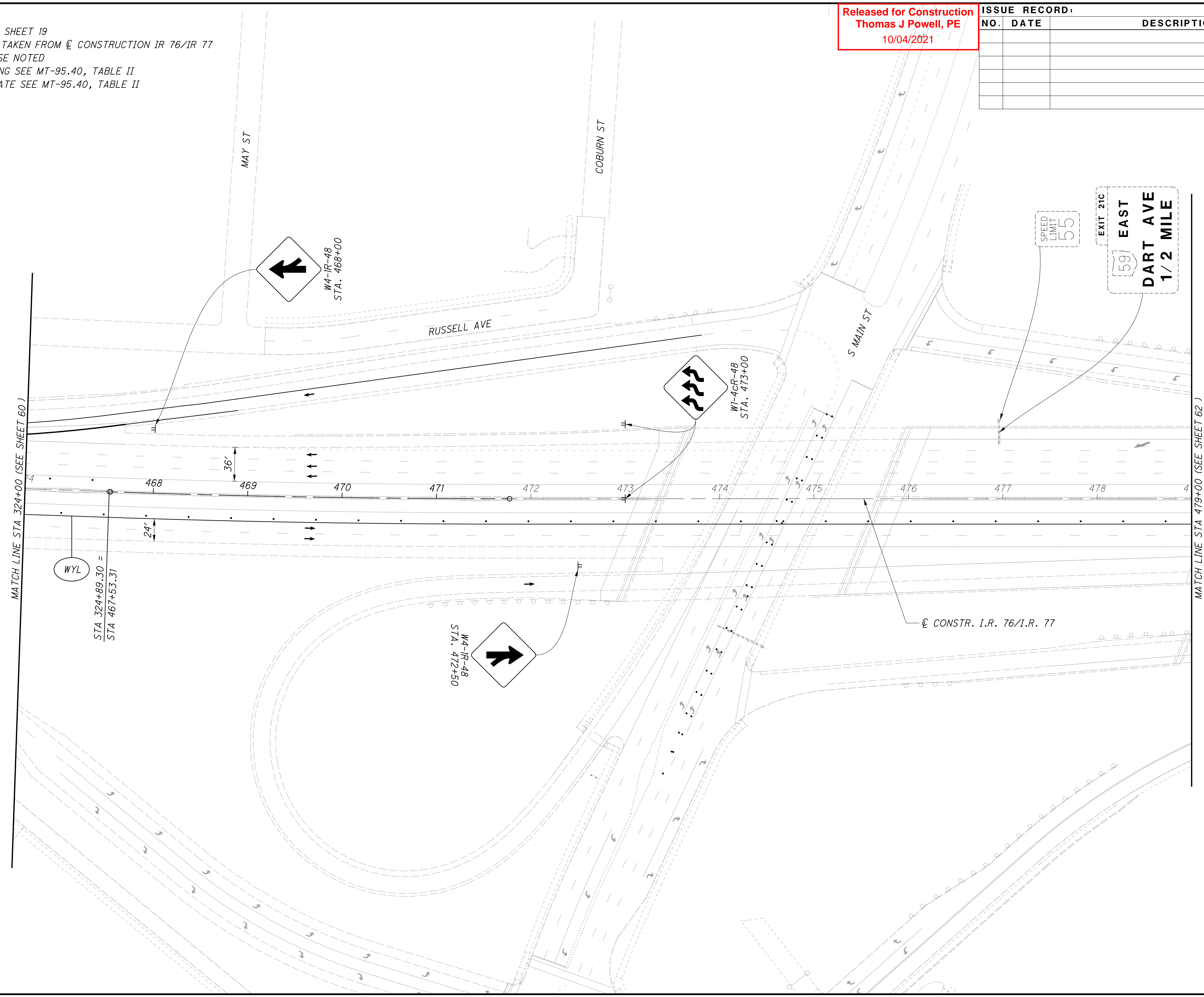

2021-09-29 - BU 05 - RELEASED FOR CONSTRUCTION PLANS

SUM-76 / 77 / 8-
8.24 / 9.74 / 0.00

MOT IR 76 / IR 77 PHASE 4A
STA 324+00 TO STA 479+00

61
105

p:\VANVAOP\WINTO\parsons.com:Ohio State\Documents\DB-Akron Beltway Rehab\10 - Design\02329\M0T\Sheets\BU-05\02329_MPBUS3JT.dgn_Sheet 9/28/2021 05:24 PM aplipchuk

Released for Construction
 Thomas J Powell, PE
 10/04/2021

ISSUE RECORD:		
NO.	DATE	DESCRIPTION

- NOTES:
- FOR LEGEND, SEE SHEET 19
 - ALL STATIONING TAKEN FROM \varnothing CONSTRUCTION IR 76 UNLESS OTHERWISE NOTED
 - FOR DRUM SPACING SEE MT-95.40, TABLE II
 - FOR PB FLARE RATE SEE MT-95.40, TABLE II

0
50
100

HORIZONTAL
SCALE IN FEET

CALCULATED

VJ

CHECKED

AVP

MATCH LINE STA 479+00 (SEE SHEET 61)

MATCH LINE STA 491+50 (SEE SHEET 63)

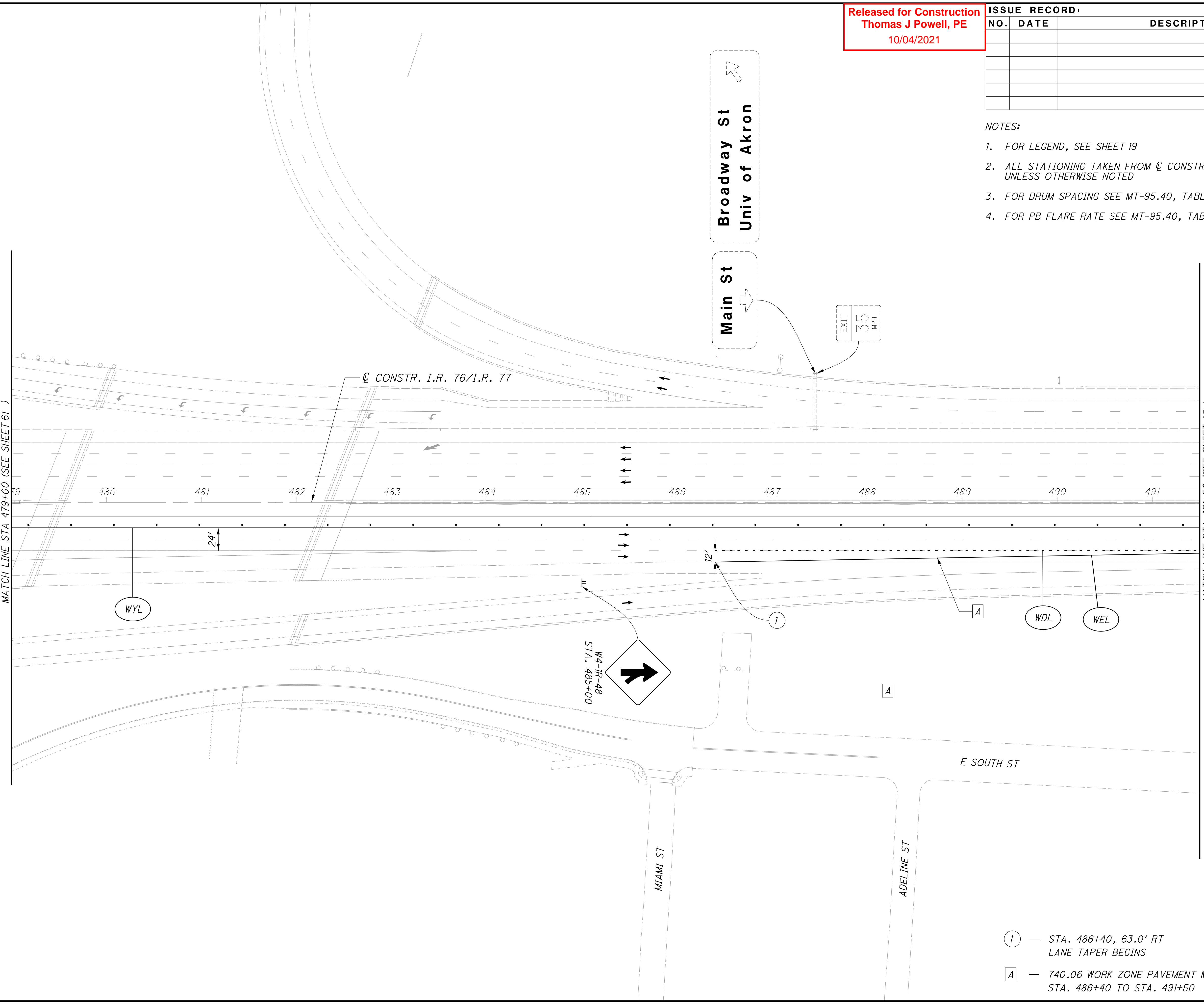

- (1) — STA. 486+40, 63.0' RT LANE TAPER BEGINS
- [A] — 740.06 WORK ZONE PAVEMENT MARKINGS, TYPE I STA. 486+40 TO STA. 491+50

2021-09-29 - BU 05 - RELEASED FOR CONSTRUCTION PLANS

MOT IR 76 / IR 77 PHASE 4A
STA 479+00 TO STA 491+50

SUM-76 / 77 / 8-
8.24 / 9.74 / 0.00

d:\VANVAIPWINTO\parsons.com\Ohio State\Documents\DB-Akron Beltway Rehab\0 - Design\02329\M0T\Sheets\BU-05\02329_MPB05318.dgn Sheet 9/28/2021 05:31 PM apilipchuk

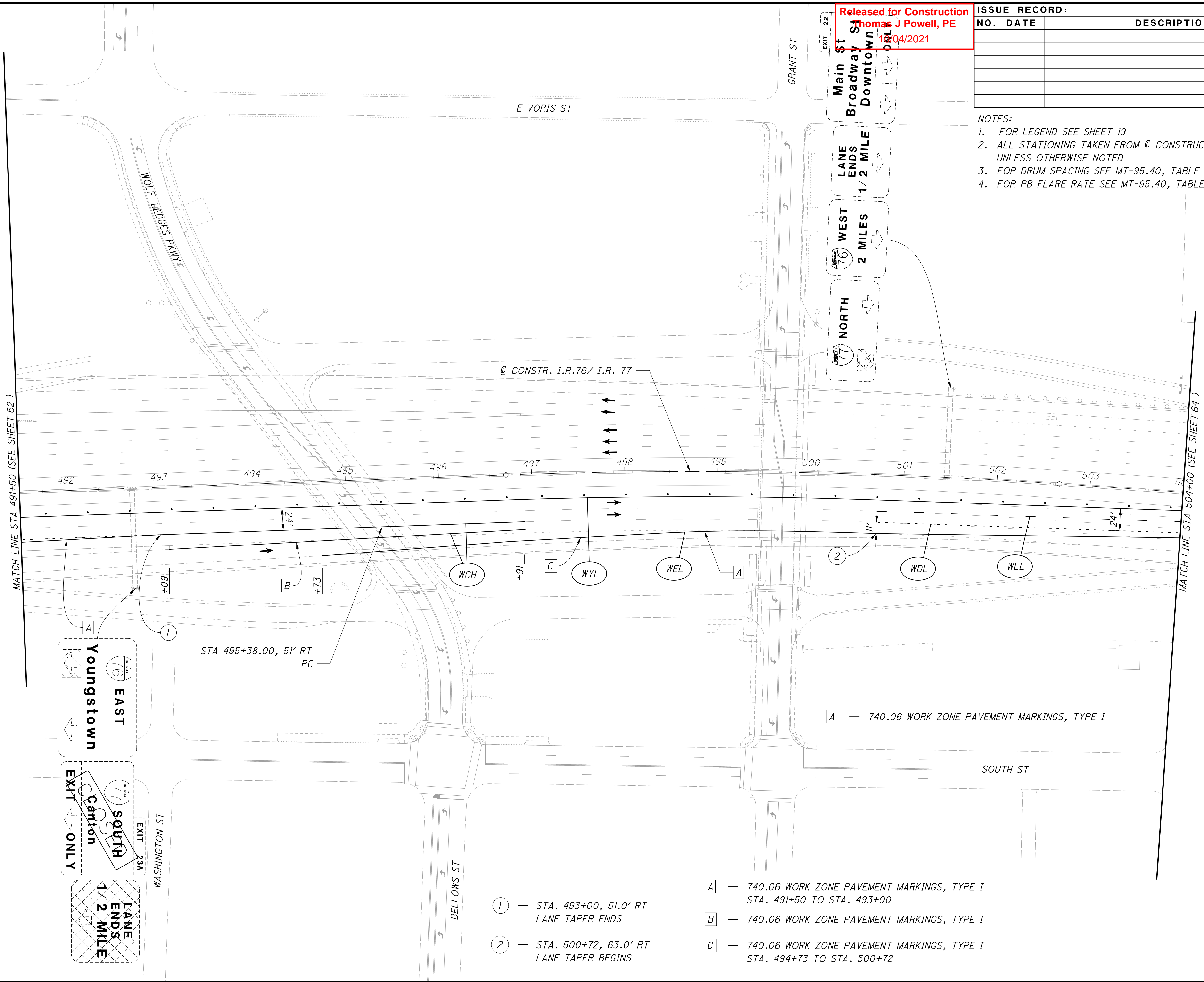

Released for Construction
 Thomas J Powell, PE
 10/04/2021

ISSUE RECORD:		
NO.	DATE	DESCRIPTION

- NOTES:
- FOR LEGEND SEE SHEET 19
 - ALL STATIONING TAKEN FROM \varnothing CONSTRUCTION IR 76/IR 77 UNLESS OTHERWISE NOTED
 - FOR DRUM SPACING SEE MT-95.40, TABLE II
 - FOR PB FLARE RATE SEE MT-95.40, TABLE II

CALCULATED VJ CHECKED AVP

0 25 50 100
 HORIZONTAL SCALE IN FEET

MATCH LINE STA 491+50 (SEE SHEET 62)

MATCH LINE STA 504+00 (SEE SHEET 64)

- ① — STA. 493+00, 51.0' RT LANE TAPER ENDS
- ② — STA. 500+72, 63.0' RT LANE TAPER BEGINS

- A — 740.06 WORK ZONE PAVEMENT MARKINGS, TYPE I STA. 491+50 TO STA. 493+00
- B — 740.06 WORK ZONE PAVEMENT MARKINGS, TYPE I
- C — 740.06 WORK ZONE PAVEMENT MARKINGS, TYPE I STA. 494+73 TO STA. 500+72

A — 740.06 WORK ZONE PAVEMENT MARKINGS, TYPE I

2021-09-29 - BU 05 - RELEASED FOR CONSTRUCTION PLANS

MOT IR 76 / IR 77 PHASE 4A
 STA 491+50 TO STA 504+00

SUM-76 / 77 / 8-
 8.24 / 9.74 / 0.00

d:\va\vaipwintol\parsons.com\Ohio State\Documents\DB-Akron Beltway Rehab\0 - Design\02329\M0T\Sheets\BU-05\02329.MPB\5319.dgn_Sheet 9/28/2021 05:41 PM apilipchuk

Released for Construction
 Thomas J Powell, PE
 10/04/2021

ISSUE RECORD:		
NO.	DATE	DESCRIPTION

- NOTES:
- FOR LEGEND SEE SHEET 19
 - ALL STATIONING TAKEN FROM \varnothing CONSTRUCTION IR 76 UNLESS OTHERWISE NOTED
 - FOR DRUM SPACING SEE MT-95.40, TABLE II
 - FOR PB FLARE RATE SEE MT-95.40, TABLE II

CALCULATED
 VJ
 CHECKED
 AVP

0 50 100
 25
 HORIZONTAL
 SCALE IN FEET

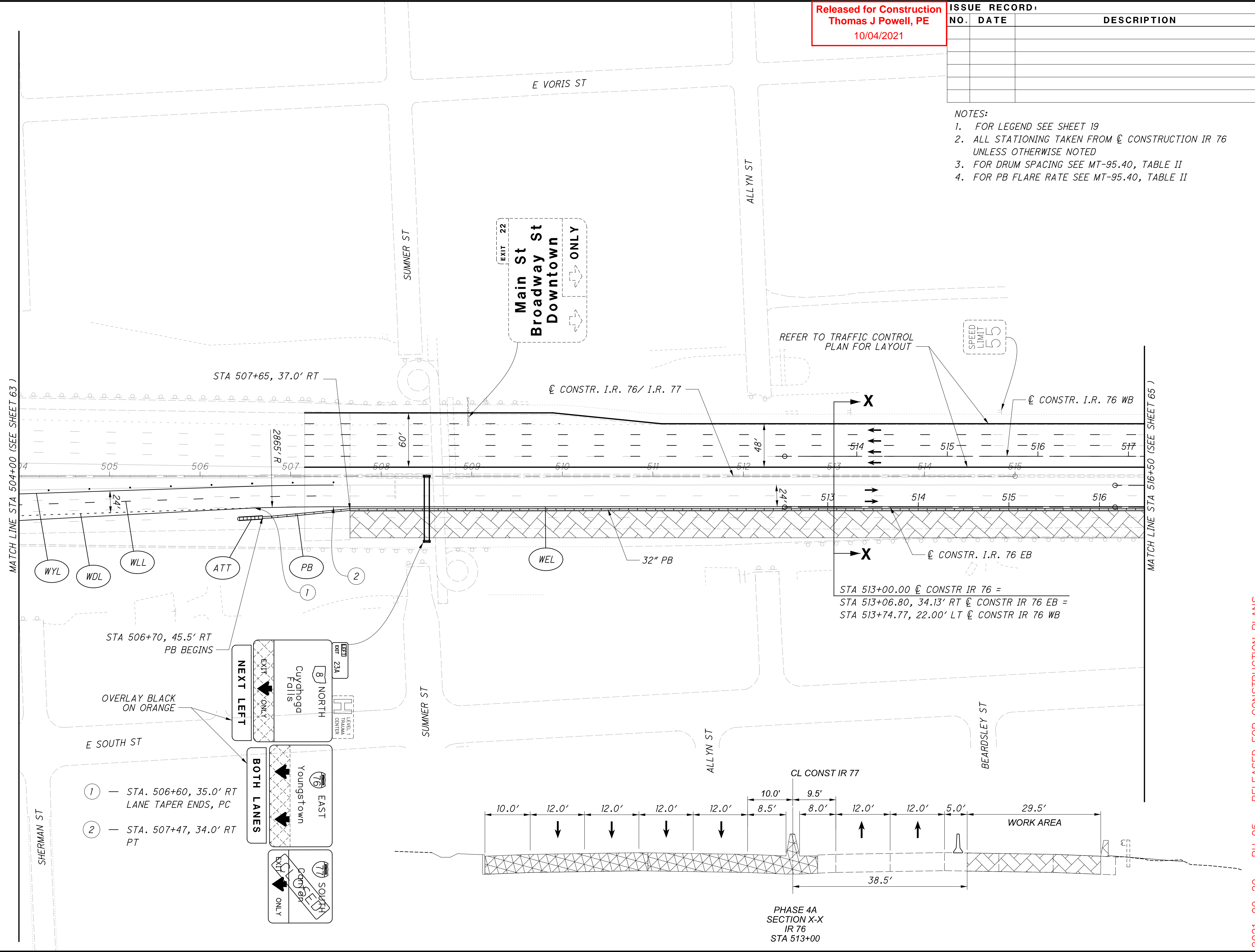

2021-09-29 - BU 05 - RELEASED FOR CONSTRUCTION PLANS

MOT IR 76 / IR 77 PHASE 4A
 STA 504+00 TO STA 516+50

SUM-76/77/8-
 8.24/9.74/0.00

d:\va\p\w\int\p\parsons.com:Ohio State\Documents\VB-Akron Beltway Rehab\10 - Design\02329\M0T\Sheets\BU-05\02329_MPBUS320.dgn Sheet 9/28/2021 10:05:48 PM aplipchuk

Released for Construction
 Thomas J Powell, PE
 10/04/2021

ISSUE RECORD:		
NO.	DATE	DESCRIPTION

- NOTES:
- FOR LEGEND SEE SHEET 19
 - ALL STATIONING TAKEN FROM \odot CONSTRUCTION IR 76 WB UNLESS OTHERWISE NOTED
 - FOR DRUM SPACING SEE MT-95.40, TABLE II
 - FOR PB FLARE RATE SEE MT-95.40, TABLE II

100
 50
 0
 HORIZONTAL
 SCALE IN FEET

CALCULATED VJ
 CHECKED AVP

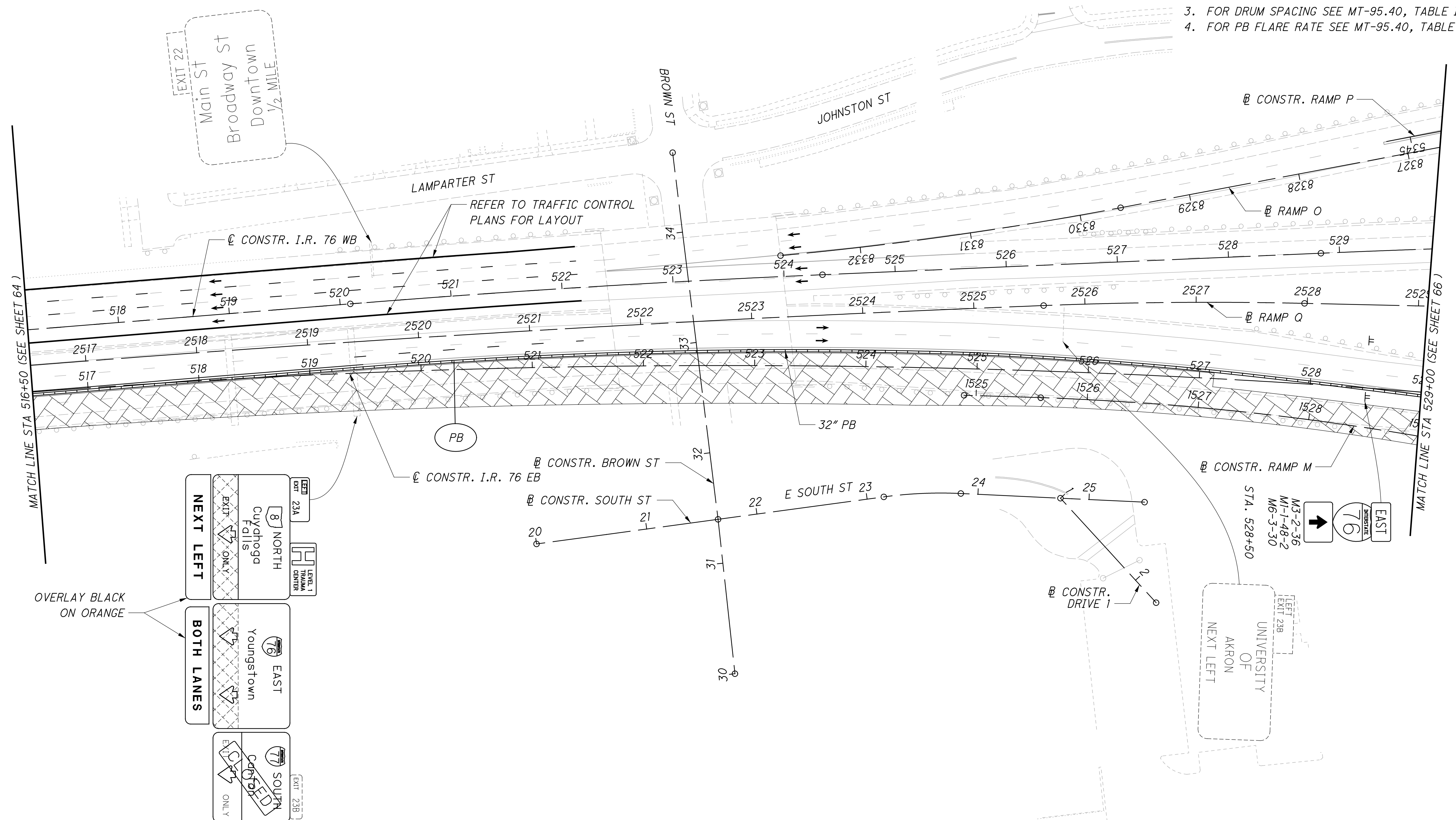

OVERLAY BLACK ON ORANGE

NEXT LEFT EXIT 23A NORTH Cuyahoga Falls TRAMA CENTER LEGEND 1
BOTH LANES EAST Youngstown CUYAHOGA FALLS LEGEND 2
SOUTH Cuyahoga Falls LEGEND 3 EXIT 23B

2021-09-29 - BU 05 - RELEASED FOR CONSTRUCTION PLANS

MOT IR 76 / IR 77 PHASE 4A
 STA 516+50 TO STA 529+00

SUM-76 / 77 / 8-
 8.24 / 9.74 / 0.00

d:\VANVAOPWINTO\parsons.com\Ohio State\Documents\DB-Akron Beltway Rehab\10 - Design\02329\MOT\Sheets\BU-05\02329.MOT\Sheets\BU-05\02329.MPB\5321.dgn Sheet 9/28/2021 10:55:55 PM aplipchuk

Released for Construction
Thomas J Powell, PE
10/04/2021

ISSUE RECORD:		
NO.	DATE	DESCRIPTION

- NOTES:
- FOR LEGEND SEE SHEET 19
 - ALL STATIONING TAKEN FROM \varnothing CONSTRUCTION IR 76 EB UNLESS OTHERWISE NOTED
 - FOR DRUM SPACING SEE MT-95.40, TABLE II
 - FOR PB FLARE RATE SEE MT-95.40, TABLE II

CALCULATED VJ CHECKED AVP

0 50 100
25
HORIZONTAL SCALE IN FEET

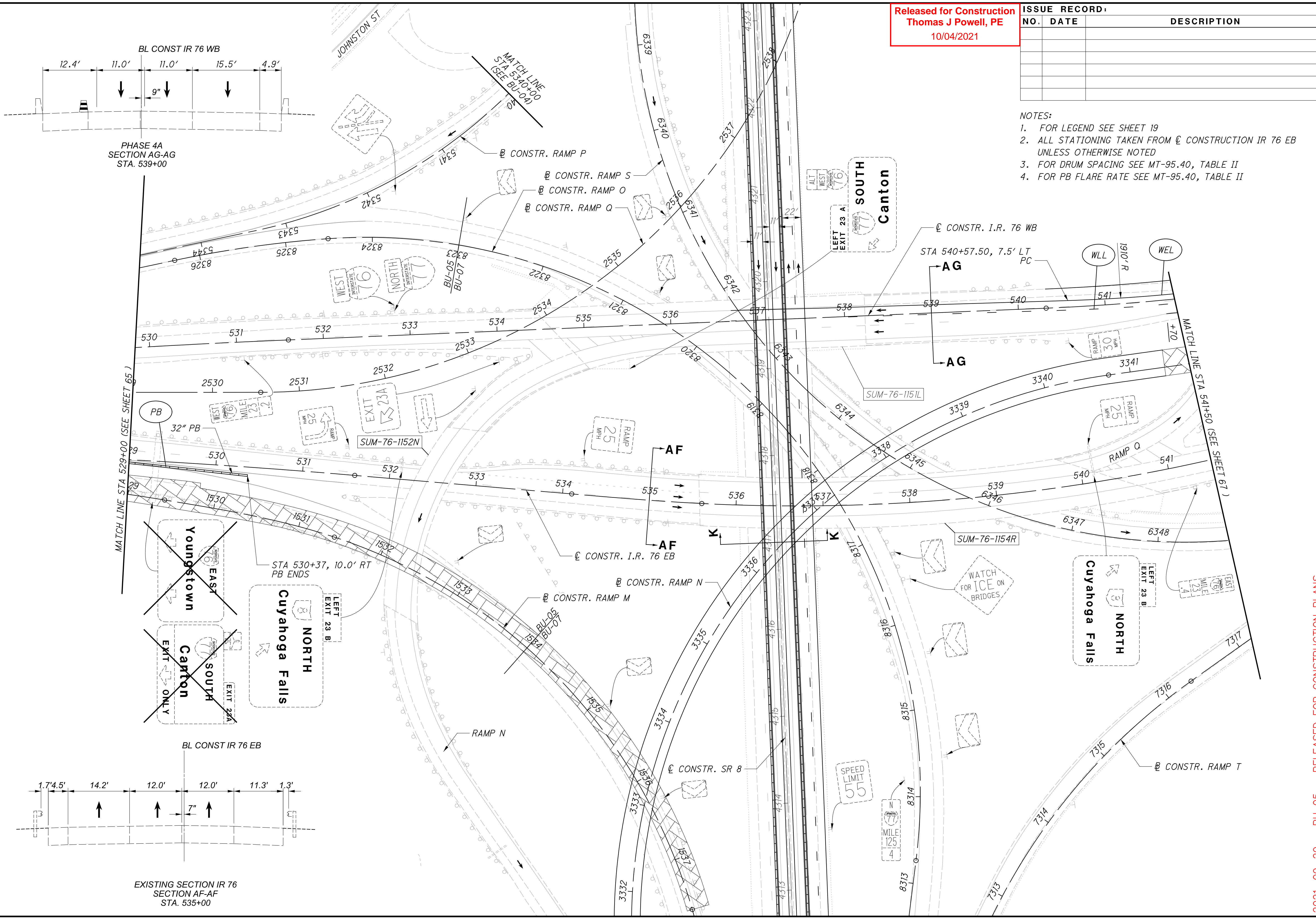

2021-09-29 - BU 05 - RELEASED FOR CONSTRUCTION PLANS

MOT IR 76 / IR 77 PHASE 4A
SUM-76 / 77 / 8 -
STA 529+00 TO STA 541+50
8.24 / 9.74 / 0.00

d:\va\va01p\wintol\parsons.com\Ohio State\Documents\DB-Akron Beltway Rehab\0 - Design\02329\MOT\Sheets\BU-05\02329_MPBUS323.dgn Sheet 9/28/2021 10:06:02 PM aplipchuk

Released for Construction
 Thomas J Powell, PE
 10/04/2021

ISSUE RECORD:		
NO.	DATE	DESCRIPTION

NOTES:

- FOR LEGEND SEE SHEET 19
- ALL STATIONING TAKEN FROM \odot CONSTRUCTION IR 76 WB UNLESS OTHERWISE NOTED
- FOR DRUM SPACING SEE MT-95.40, TABLE II
- FOR PB FLARE RATE SEE MT-95.40, TABLE II

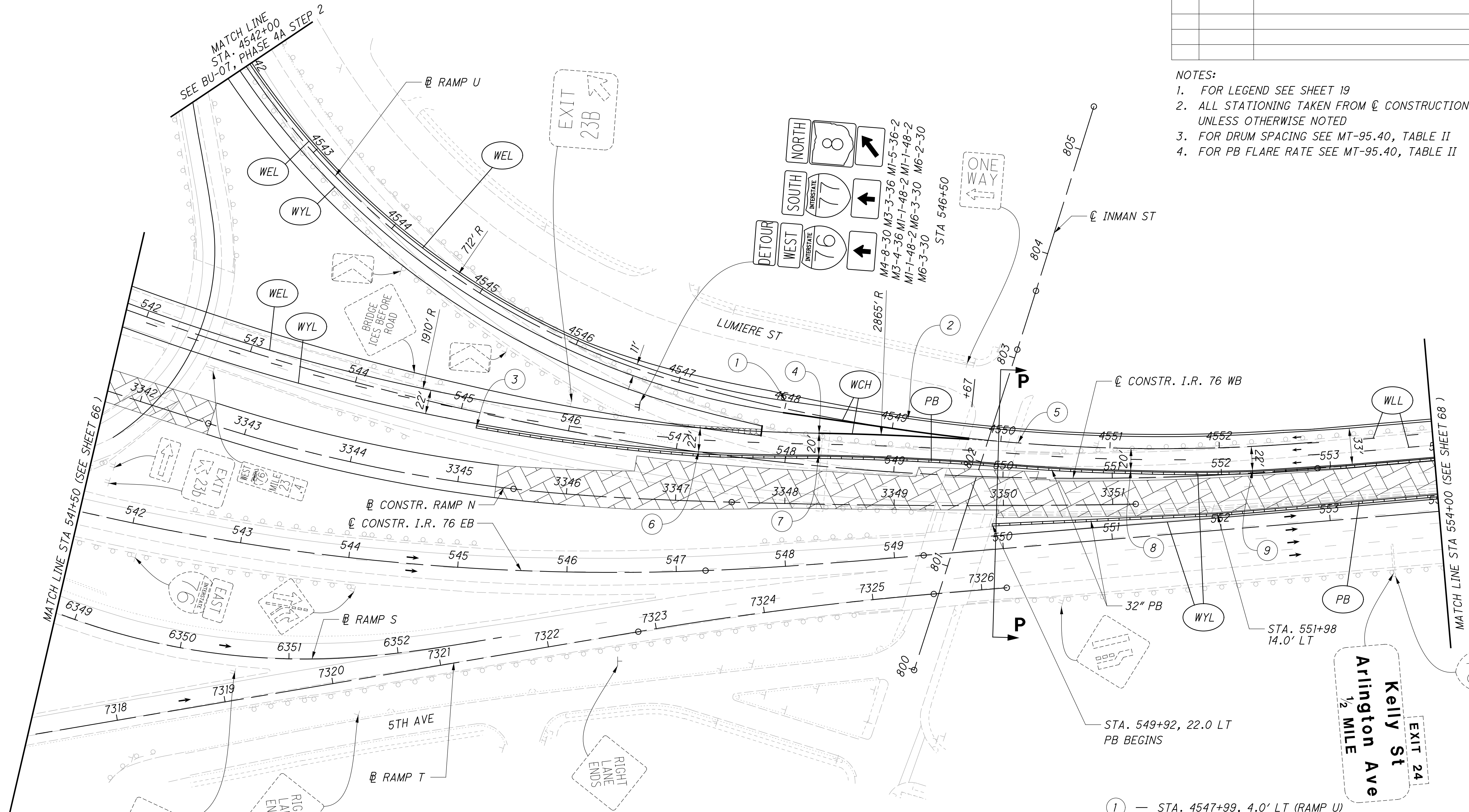

- ① — STA. 4547+99, 4.0' LT (RAMP U) PT
- ② — STA. 4549+13, 11.0' LT (RAMP U)
- ③ — STA. 545+17, 13.5' RT PB BEGINS
- ④ — STA. 548+28.50, 29.5' LT PRC
- ⑤ — STA. 4550+15.75, \odot PT
- ⑥ — STA. 547+20.50, \odot LANE TAPER BEGINS 2' INSIDE SHOULDER
- ⑦ — STA. 548+30.21, 10.0' LT LANE TAPER ENDS 1' INSIDE SHOULDER
- ⑧ — STA. 551+17.00, 7.0' LT LANE TAPER BEGINS
- ⑨ — STA. 552+28.50, 2.5' LT LANE TAPER ENDS

2021-09-29 - BU 05 - RELEASED FOR CONSTRUCTION PLANS

MOT IR 76 / IR 77 PHASE 4A
SUM-76 / 77 / 8-
STA 541+50 TO STA 554+00
8.24 / 9.74 / 0.00

p:\VANVAIPWINTO\parsons.com\Ohio State\Documents\DB-Akron Beltway Rehab\10 - Design\02329\M0T\Sheets\BU-05\02329_MPB05324.dgn Sheet 9/28/2021 10:06:07 PM aplipchuk

Released for Construction
 Thomas J Powell, PE
 10/04/2021

ISSUE RECORD:		
NO.	DATE	DESCRIPTION

CALCULATED VJ
 CHECKED AVP

0 50 100
 25
 HORIZONTAL SCALE IN FEET

- NOTES:
- FOR LEGEND SEE SHEET 19
 - ALL STATIONING TAKEN FROM \varnothing CONSTRUCTION IR 76 WB UNLESS OTHERWISE NOTED
 - FOR DRUM SPACING SEE MT-95.40, TABLE II
 - FOR PB FLARE RATE SEE MT-95.40, TABLE II

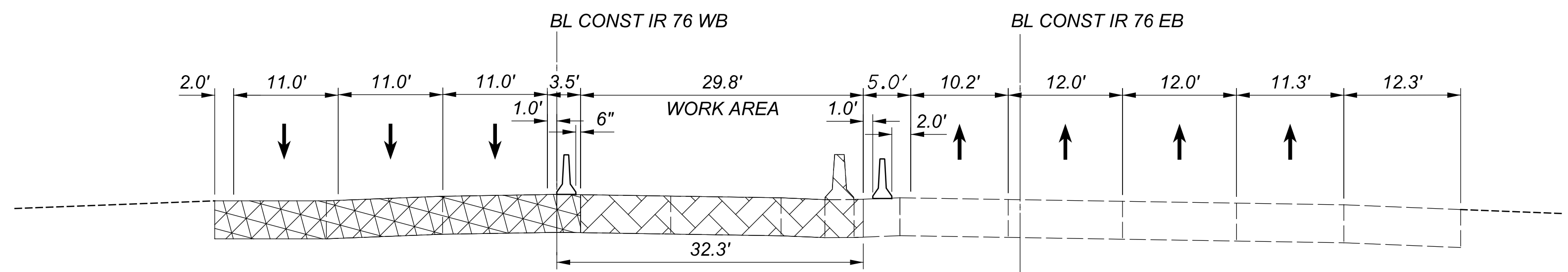
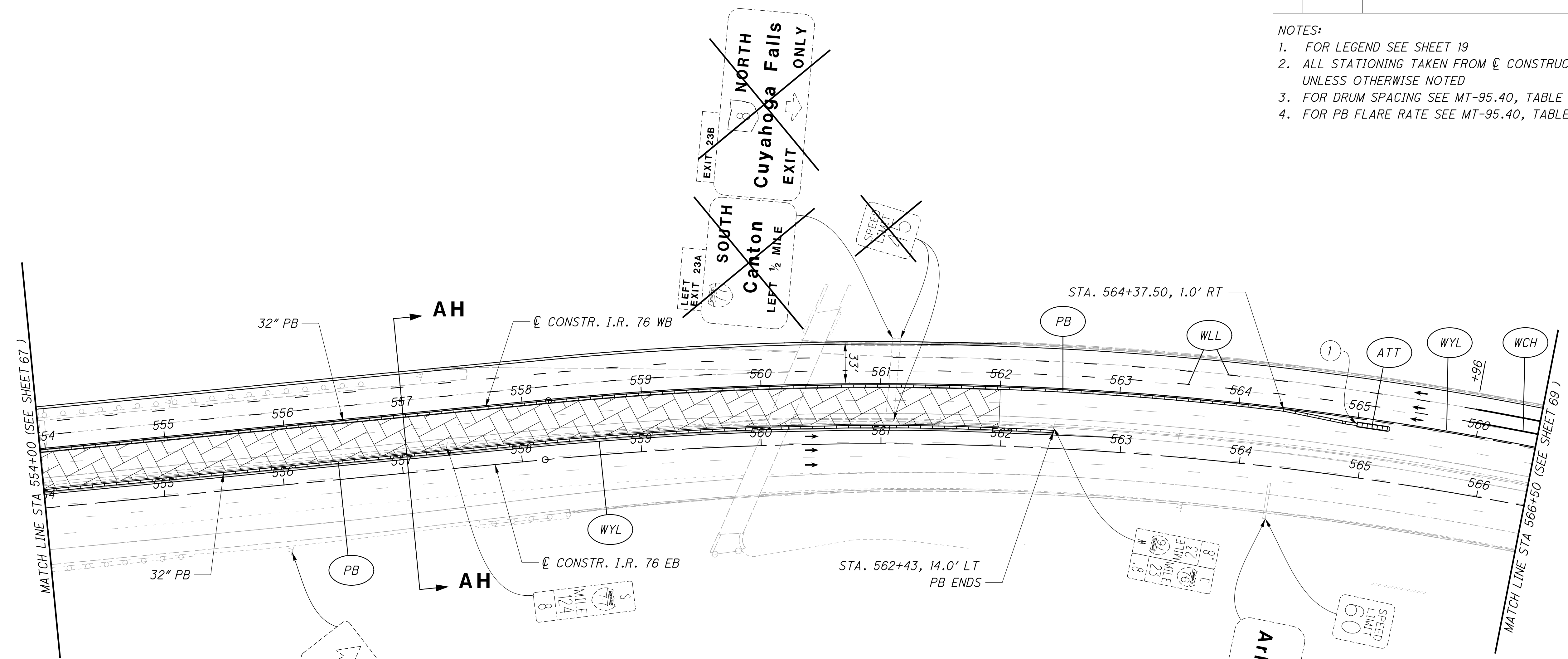

PHASE 4A
 SECTION AH-AH
 STA. 557+00

① — STA. 565+00, 5.0' RT
 PB ENDS

2021-09-29 - BU 05 - RELEASED FOR CONSTRUCTION PLANS

MOT IR 76 / IR 77 PHASE 4A
 STA 554+00 TO STA 566+50

SUM-76 / 77 / 8-
 8.24 / 9.74 / 0.00

pw:\VANVAOPWINTO\parsons.com:Ohio State\Documents\DB-Akron Beltway Rehab\10 - Design\02329\M0T\Sheets\BU-05\02329_MPB05325.dgn Sheet 9/28/2021 10:06:14 PM aplipchuk

Released for Construction
 Thomas J Powell, PE
 10/04/2021

ISSUE RECORD:		
NO.	DATE	DESCRIPTION

- NOTES:
- FOR LEGEND SEE SHEET 19
 - ALL STATIONING TAKEN FROM \varnothing CONSTRUCTION IR 76 WB UNLESS OTHERWISE NOTED
 - FOR DRUM SPACING SEE MT-95.40, TABLE II
 - FOR PB FLARE RATE SEE MT-95.40, TABLE II

CALCULATED
 V J
 CHECKED
 AVP

0 50 100
 25
 HORIZONTAL
 SCALE IN FEET

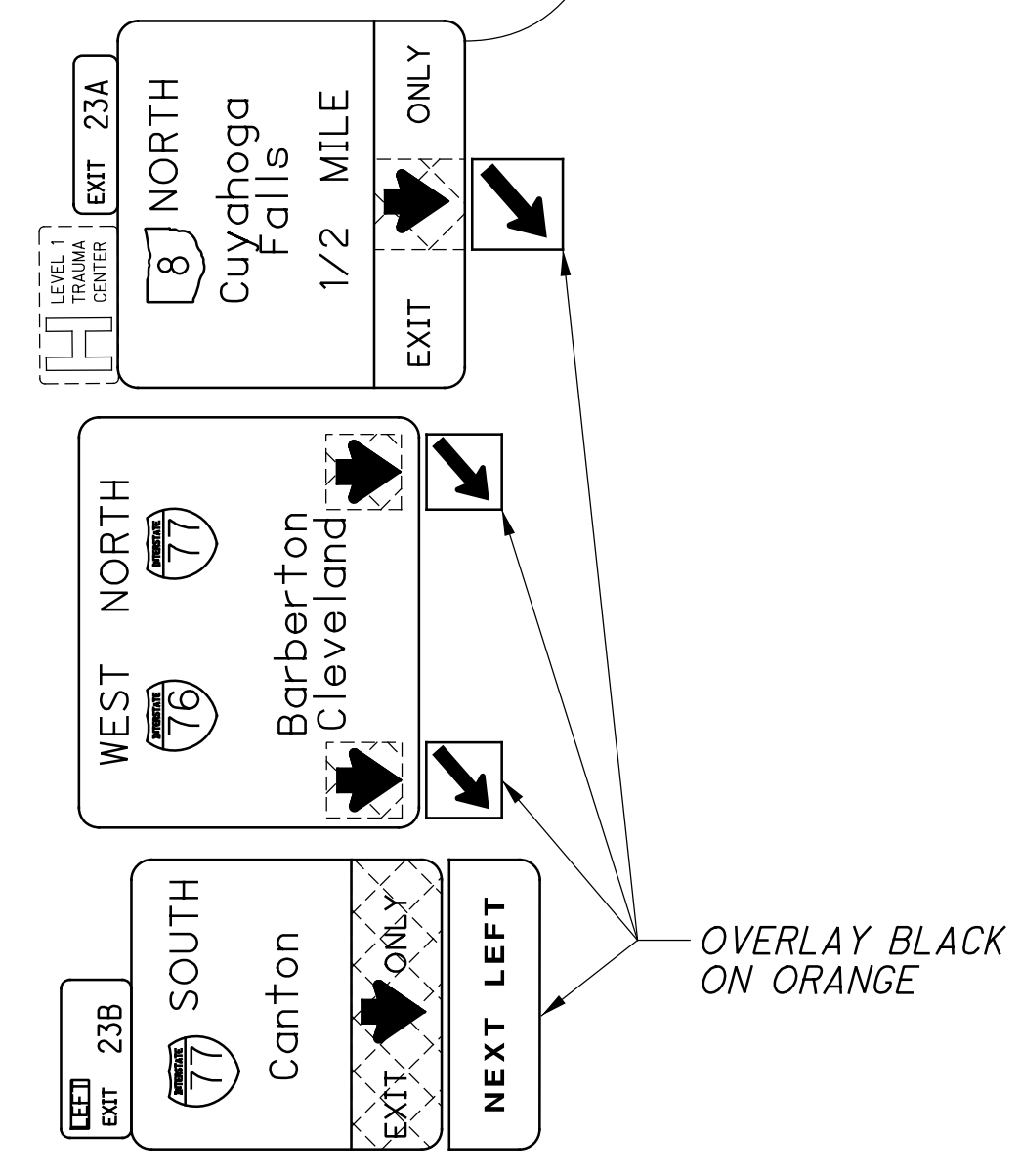
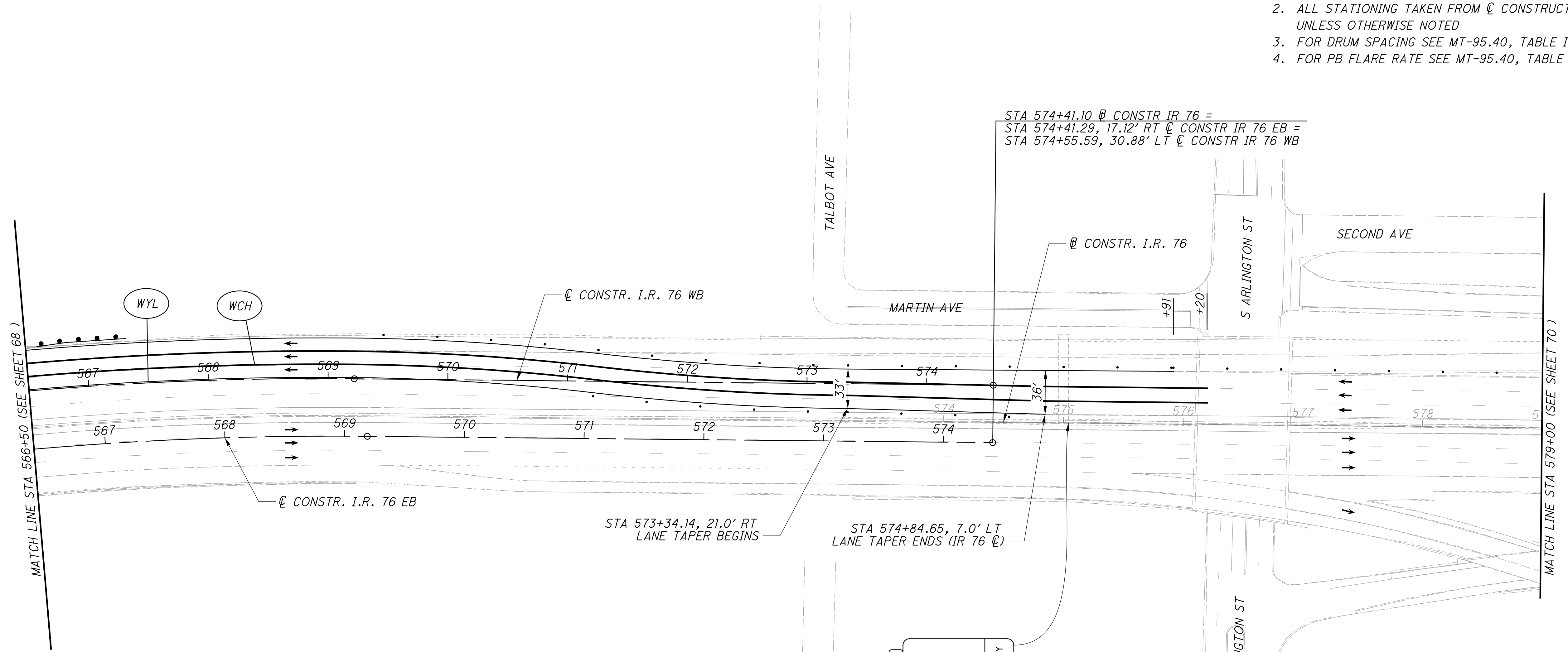

2021-09-29 - BU 05 - RELEASED FOR CONSTRUCTION PLANS

d:\va\vaipwintol\parsons.com\Ohio State\Documents\DB-Akron Beltway Rehab\10 - Design\02329\M0T\Sheets\BU-05\02329_MPB05326.dgn Sheet 9/28/2021 10:06:19 PM aplipchuk

Released for Construction
Thomas J Powell, PE
10/04/2021

ISSUE RECORD:		
NO.	DATE	DESCRIPTION

- NOTES:
1. FOR LEGEND, SEE SHEET 19
 2. ALL STATIONING TAKEN FROM I.R. 76 CONSTRUCTION IR 76 UNLESS OTHERWISE NOTED
 3. FOR DRUM SPACING SEE MT-95.40, TABLE II
 4. FOR PB FLARE RATE SEE MT-95.40, TABLE II

CALCULATED
VJ
CHECKED
AVP

0 50 100
HORIZONTAL
SCALE IN FEET

MATCH LINE STA 579+00 (SEE SHEET 69)

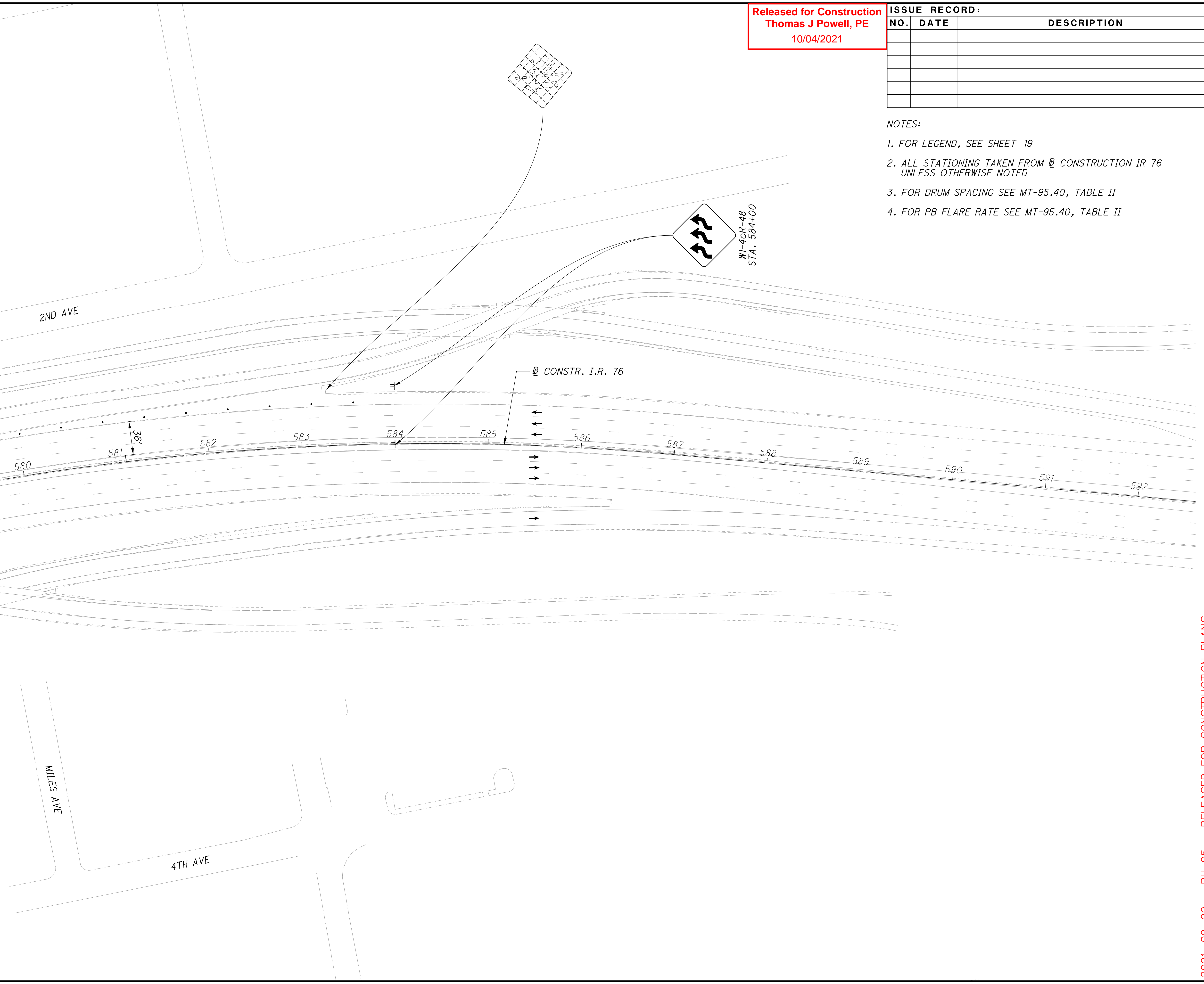

2021-09-29 - BU 05 - RELEASED FOR CONSTRUCTION PLANS

MOT IR 76 / IR 77 PHASE 4A
STA 579+00 TO STA 591+50

SUM-76 / 77 / 8-
8.24 / 9.74 / 0.00

70
105

pw:\VANVAOPWINTO\parsons.com:Ohio State\Documents\DB-Akron Beltway Rehab\0 - Design\02329\M0T\Sheets\BU-05\02329_MPB05417.dgn_Sheet 9/28/2021 10:06:27 PM aplipchuk

ADVANCED WARNING SIGN (IR 77 SB)

TYPE A WARNING LIGHT

W20-5-48 STA. 320+00

W4-2L-48 STA. 475+40

Released for Construction
 Thomas J Powell, PE
 10/04/2021

ISSUE RECORD:		
NO.	DATE	DESCRIPTION

- NOTES:
- FOR LEGEND, SEE SHEET 19
 - ALL STATIONING TAKEN FROM \hat{C} CONSTRUCTION IR 76/IR 77 UNLESS OTHERWISE NOTED
 - FOR DRUM SPACING SEE MT-95.40, TABLE II
 - FOR PB FLARE RATE SEE MT-95.40, TABLE II

0 25 50 100
 HORIZONTAL SCALE IN FEET

CALCULATED VJ
 CHECKED AVP

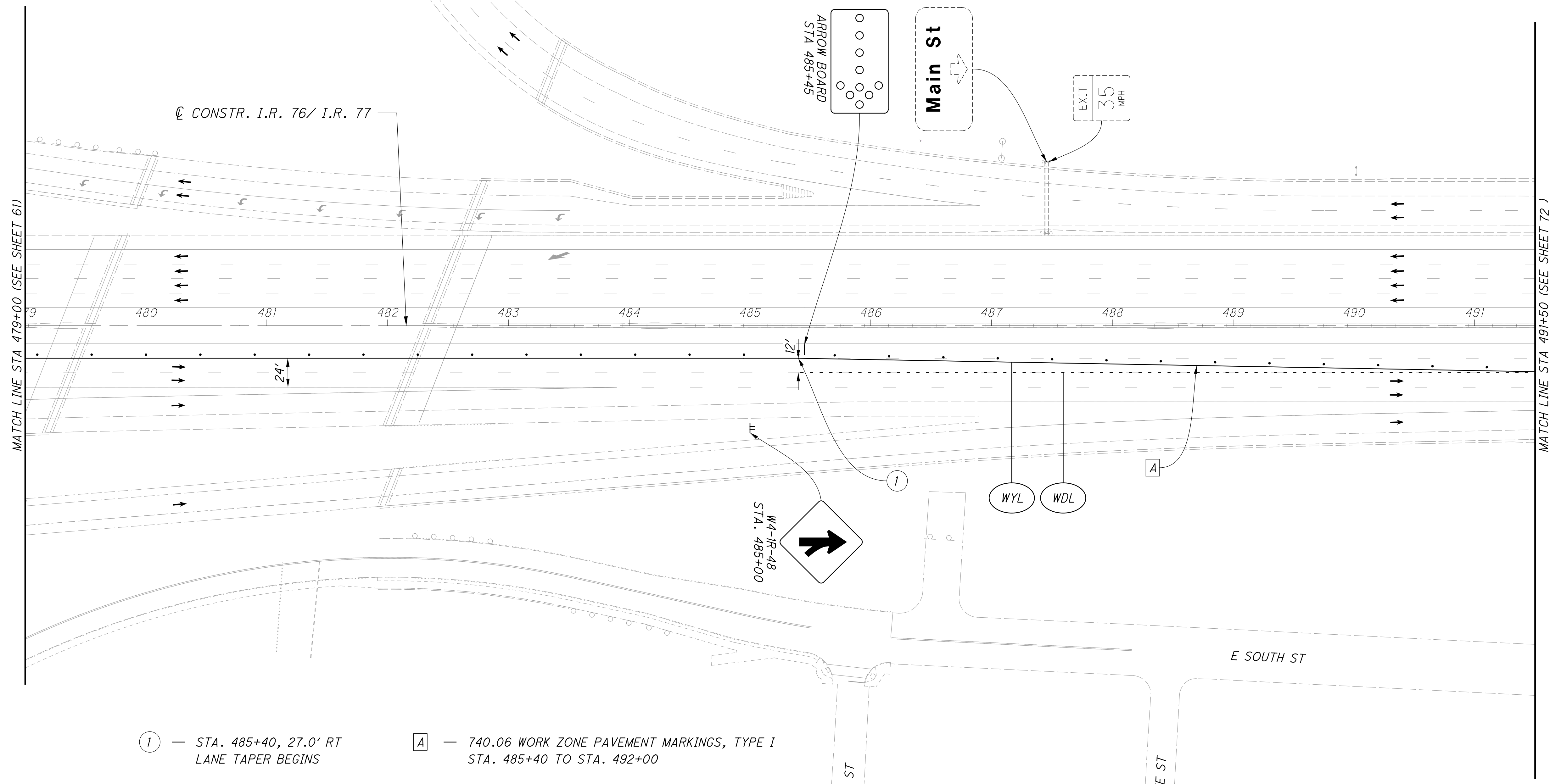

- ① — STA. 485+40, 27.0' RT LANE TAPER BEGINS
- A — 740.06 WORK ZONE PAVEMENT MARKINGS, TYPE I STA. 485+40 TO STA. 492+00

2021-09-29 - BU 05 - RELEASED FOR CONSTRUCTION PLANS

MOT IR 76 / IR 77 PHASE 4B STEPS 1 & 2
 STA 479+00 TO STA 491+50

SUM-76 / 77 / 8-
 8.24 / 9.74 / 0.00

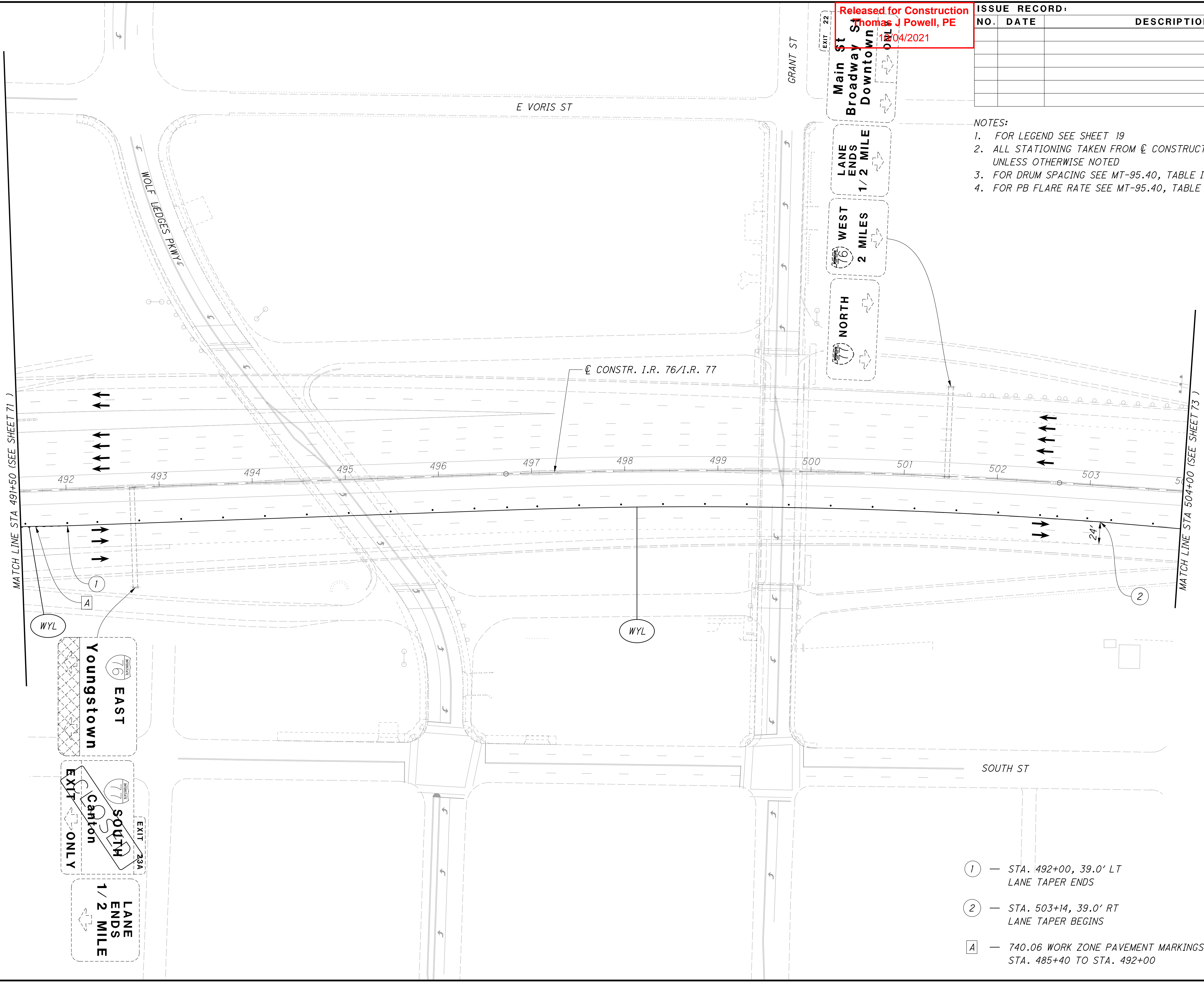

Released for Construction
 Thomas J Powell, PE
 10/04/2021

ISSUE RECORD:		
NO.	DATE	DESCRIPTION

- NOTES:
- FOR LEGEND SEE SHEET 19
 - ALL STATIONING TAKEN FROM CL CONSTRUCTION IR 76/IR 77 UNLESS OTHERWISE NOTED
 - FOR DRUM SPACING SEE MT-95.40, TABLE II
 - FOR PB FLARE RATE SEE MT-95.40, TABLE II

CALCULATED VJ
 CHECKED AVP
 0 25 50 100
 HORIZONTAL SCALE IN FEET

- ① — STA. 492+00, 39.0' LT LANE TAPER ENDS
- ② — STA. 503+14, 39.0' RT LANE TAPER BEGINS
- A — 740.06 WORK ZONE PAVEMENT MARKINGS, TYPE I STA. 485+40 TO STA. 492+00

\\VANVAOPWINTO\parsons.com\Ohio State\Documents\Beltway-Akron\Beltway Rehab\0 - Design\02329\M0T\Sheets\BU-05\02329_MPBUS49.dgn_Sheet 9/28/2021 10:06:41 PM aplipchuk

Released for Construction
 Thomas J Powell, PE
 10/04/2021

ISSUE RECORD:		
NO.	DATE	DESCRIPTION

- NOTES:
- FOR LEGEND, SEE SHEET 19
 - ALL STATIONING TAKEN FROM ϕ CONSTRUCTION IR 76 / IR 77 UNLESS OTHERWISE NOTED
 - FOR DRUM SPACING SEE MT-95.40, TABLE II
 - FOR PB FLARE RATE SEE MT-95.40, TABLE II

CALCULATED
 VJ
 CHECKED
 AVP

0 50 100
 25
 HORIZONTAL
 SCALE IN FEET

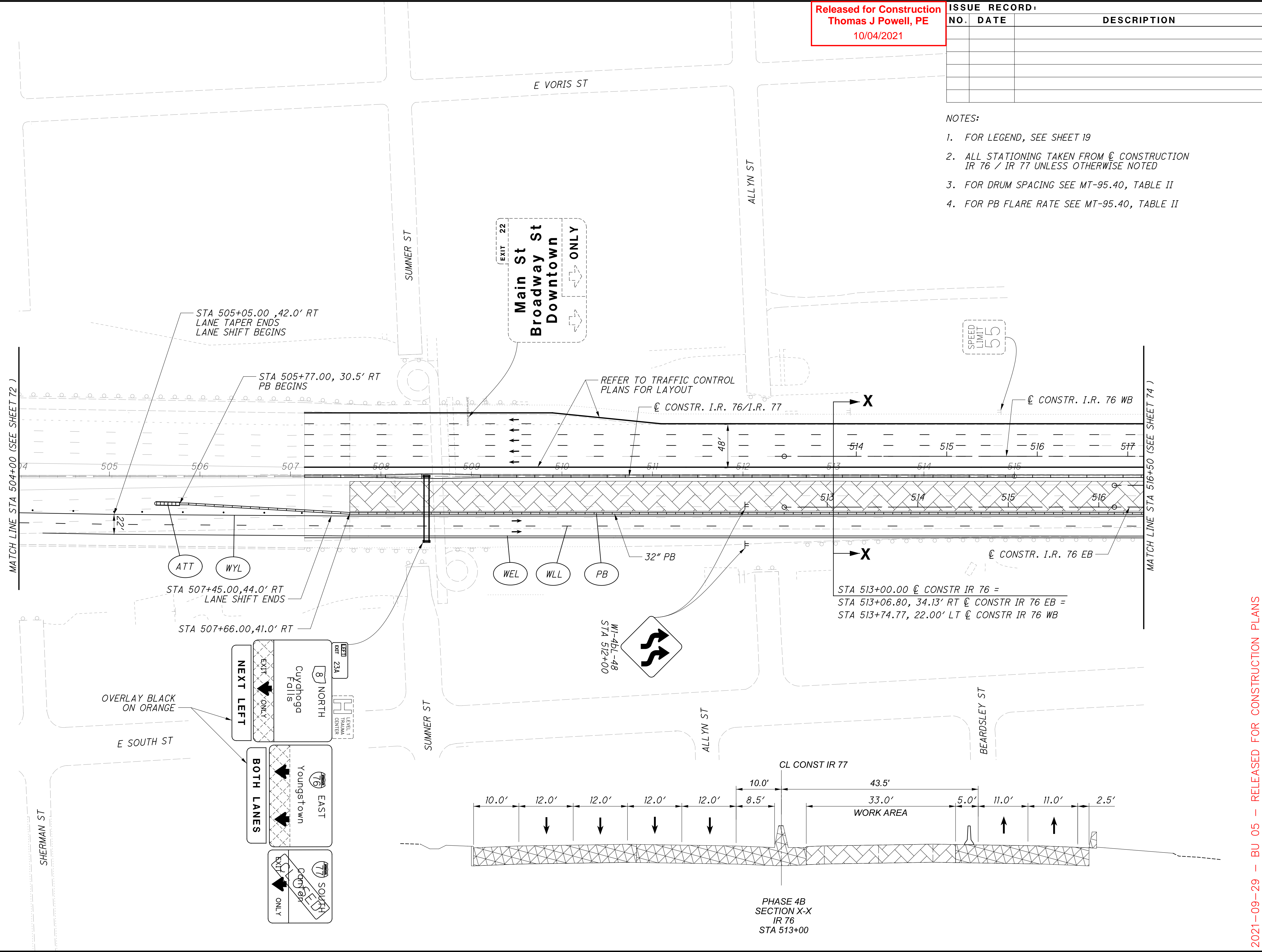

2021-09-29 - BU 05 - RELEASED FOR CONSTRUCTION PLANS

MOT IR 76 / IR 77 PHASE 4B - STEP 1
 STA 504+00 TO STA 516+50

SUM-76/77/8-
 8.24/9.74/0.00

pw:\VANVAOPWINTO\parsons.com:Ohio State\Documents\DB-Akron Beltway Rehab\0 - Design\02329\M0T\Sheets\BU-05\02329_MPBUS420.dgn Sheet 9/28/2021 10:06:48 PM aplipchuk

Released for Construction
 Thomas J Powell, PE
 10/04/2021

ISSUE RECORD:		
NO.	DATE	DESCRIPTION

NOTES:

- FOR LEGEND, SEE SHEET 19
- ALL STATIONING TAKEN FROM \odot CONSTRUCTION IR 76 EB UNLESS OTHERWISE NOTED
- FOR DRUM SPACING SEE MT-95.40, TABLE II
- FOR PB FLARE RATE SEE MT-95.40, TABLE II

0
100

HORIZONTAL
SCALE IN FEET

CALCULATED

VJ

CHECKED

AVP

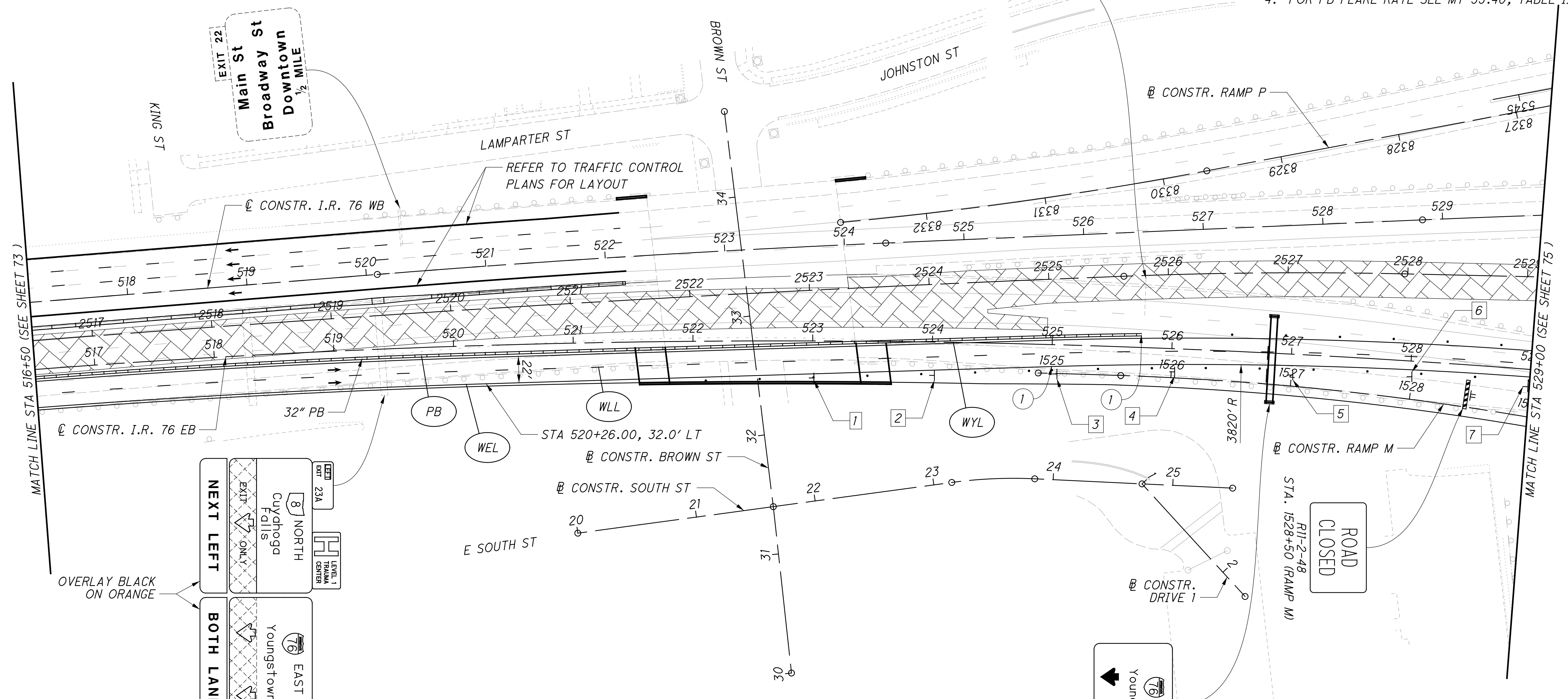

OVERLAY BLACK ON ORANGE

NEXT LEFT
 8 NORTH
 Cuyahoga Falls
 EXIT 23A
 TRAMA CENTER

BOTH LANES
 16 EAST
 Youngstown
 EXIT 23B

SOUTH
 77 SOUTH
 ONLY
 EXIT 238

- ① - STA. 525+00.00, 18.5' RT PC
 - ② - STA. 525+74, 10.5' LT PB ENDS
- W1-H16-48

 - 1 - STA 523+00
 - 2 - STA 524+00
 - 3 - STA 525+00
 - 4 - STA 526+00
 - 5 - STA 527+00
 - 6 - STA 528+00
 - 7 - STA 529+00

2021-09-29 - BU 05 - RELEASED FOR CONSTRUCTION PLANS

MOT IR 76 / IR 77 PHASE 4B - STEP 1
 STA 516+50 TO STA 529+00
 SUM-76 / 77 / 8-8.24 / 9.74 / 0.00

d:\va\vaipwint\parsons.com\Ohio State\Documents\DB-Akron Beltway Rehab\0 - Design\02329\M0T\Sheets\BU-05\02329.MPB\BU5421.dgn Sheet 9/28/2021 10:06:54 PM aplipchuk

Released for Construction
 Thomas J Powell, PE
 10/04/2021

ISSUE RECORD:		
NO.	DATE	DESCRIPTION

- NOTES:
- FOR LEGEND SEE SHEET 19
 - ALL STATIONING TAKEN FROM @ CONSTRUCTION IR 76 EB UNLESS OTHERWISE NOTED
 - FOR DRUM SPACING SEE MT-95.40, TABLE II
 - FOR PB FLARE RATE SEE MT-95.40, TABLE II

CALCULATED VJ
 CHECKED AVP

0 50 100
 HORIZONTAL SCALE IN FEET

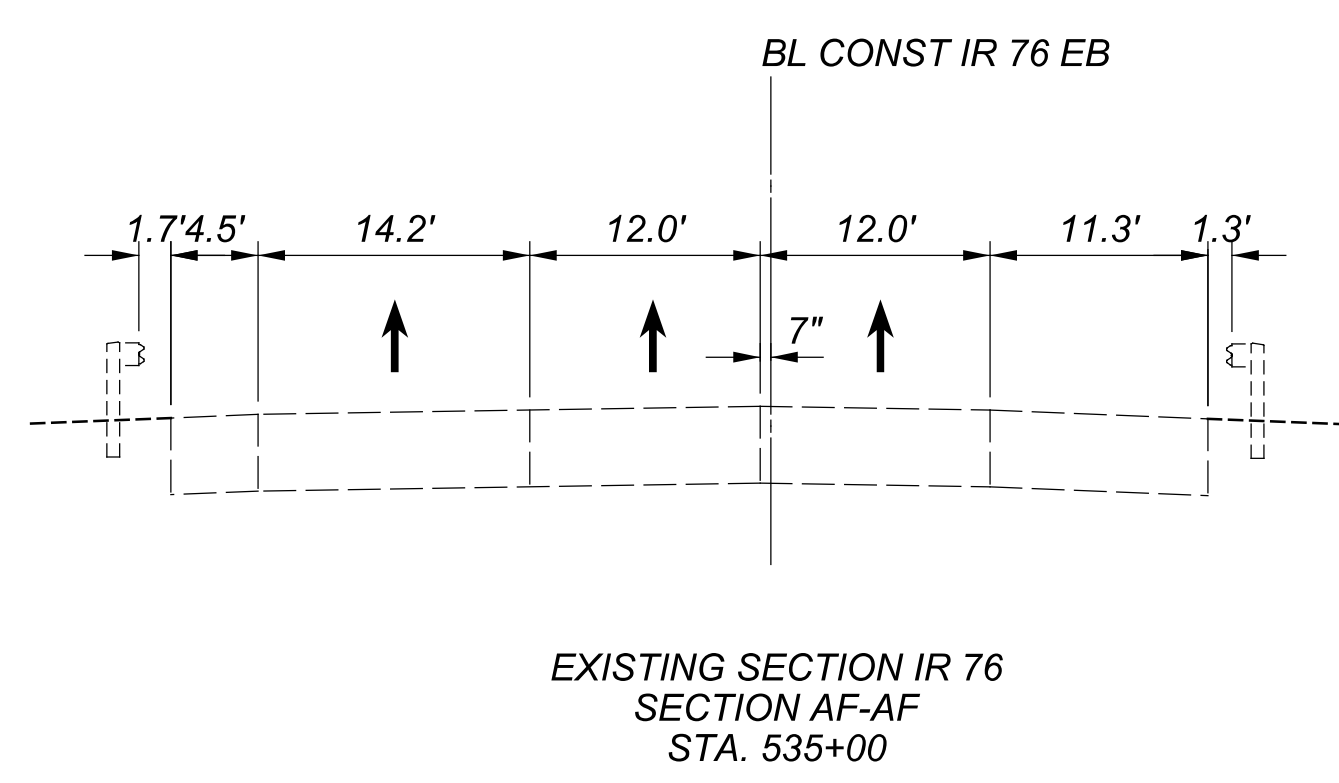
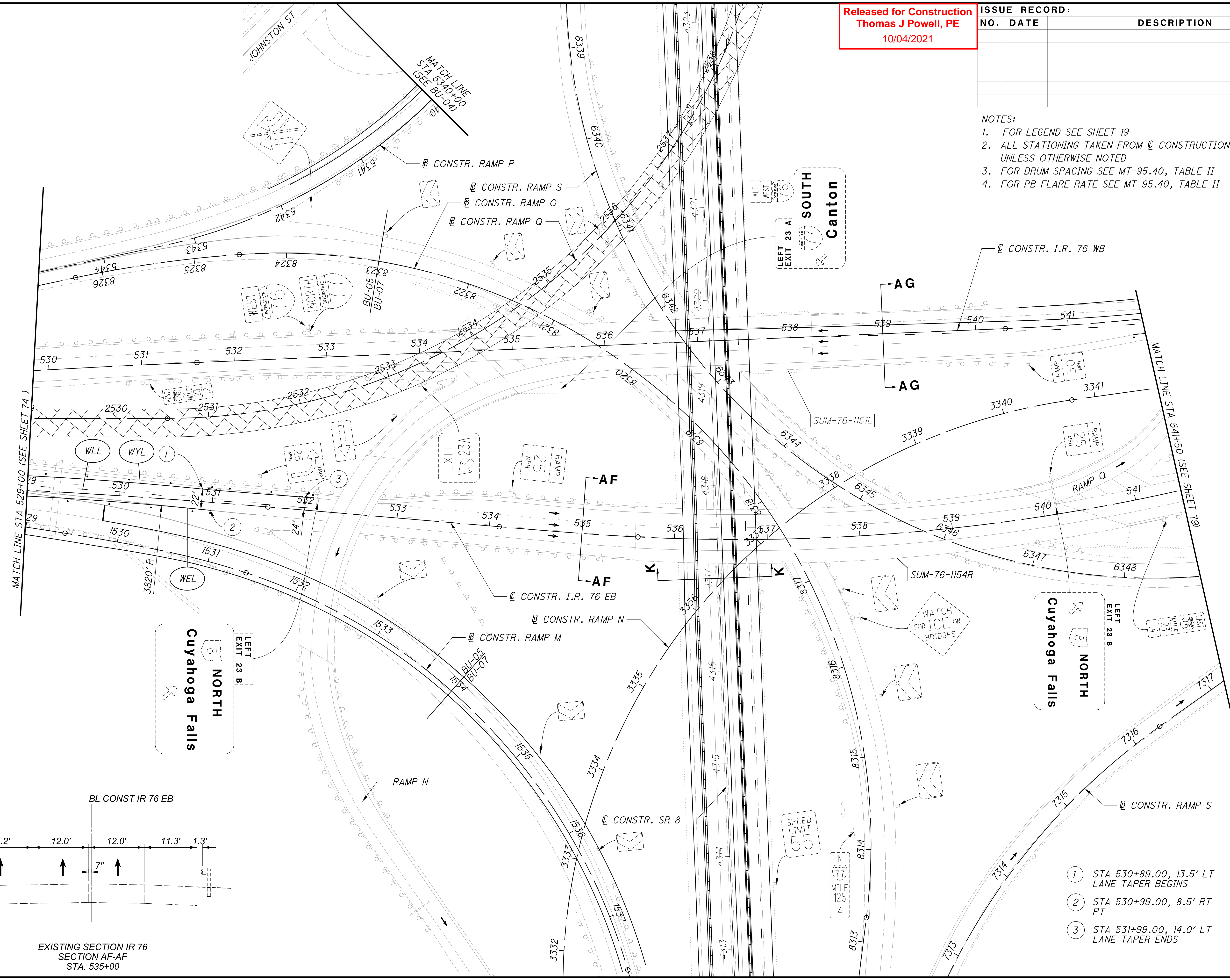

- STA 530+89.00, 13.5' LT LANE TAPER BEGINS
- STA 530+99.00, 8.5' RT PT
- STA 531+99.00, 14.0' LT LANE TAPER ENDS

2021-09-29 - BU 05 - RELEASED FOR CONSTRUCTION PLANS

MOT IR 76 / IR 77 PHASE 4B - STEP 1
 SUM-76 / 77 / 8 -
 STA 529+00 TO STA 541+50
 8.24 / 9.74 / 0.00

75
 105

d:\va\vaipwintol\parsons.com\Ohio State\Documents\Beltway Rehab\0 - Design\02329\M0T\Sheets\BU-05\02329_MPB05419.dgn Sheet 9/28/2021 1:07:01 PM aplipchuk

Released for Construction
 Thomas J Powell, PE
 10/04/2021

ISSUE RECORD:		
NO.	DATE	DESCRIPTION

- NOTES:
- FOR LEGEND, SEE SHEET 19
 - ALL STATIONING TAKEN FROM \varnothing CONSTRUCTION IR 76 UNLESS OTHERWISE NOTED
 - FOR DRUM SPACING SEE MT-95.40, TABLE II
 - FOR PB FLARE RATE SEE MT-95.40, TABLE II

CALCULATED
 V J
 CHECKED
 AVP

0 50 100
 HORIZONTAL
 SCALE IN FEET

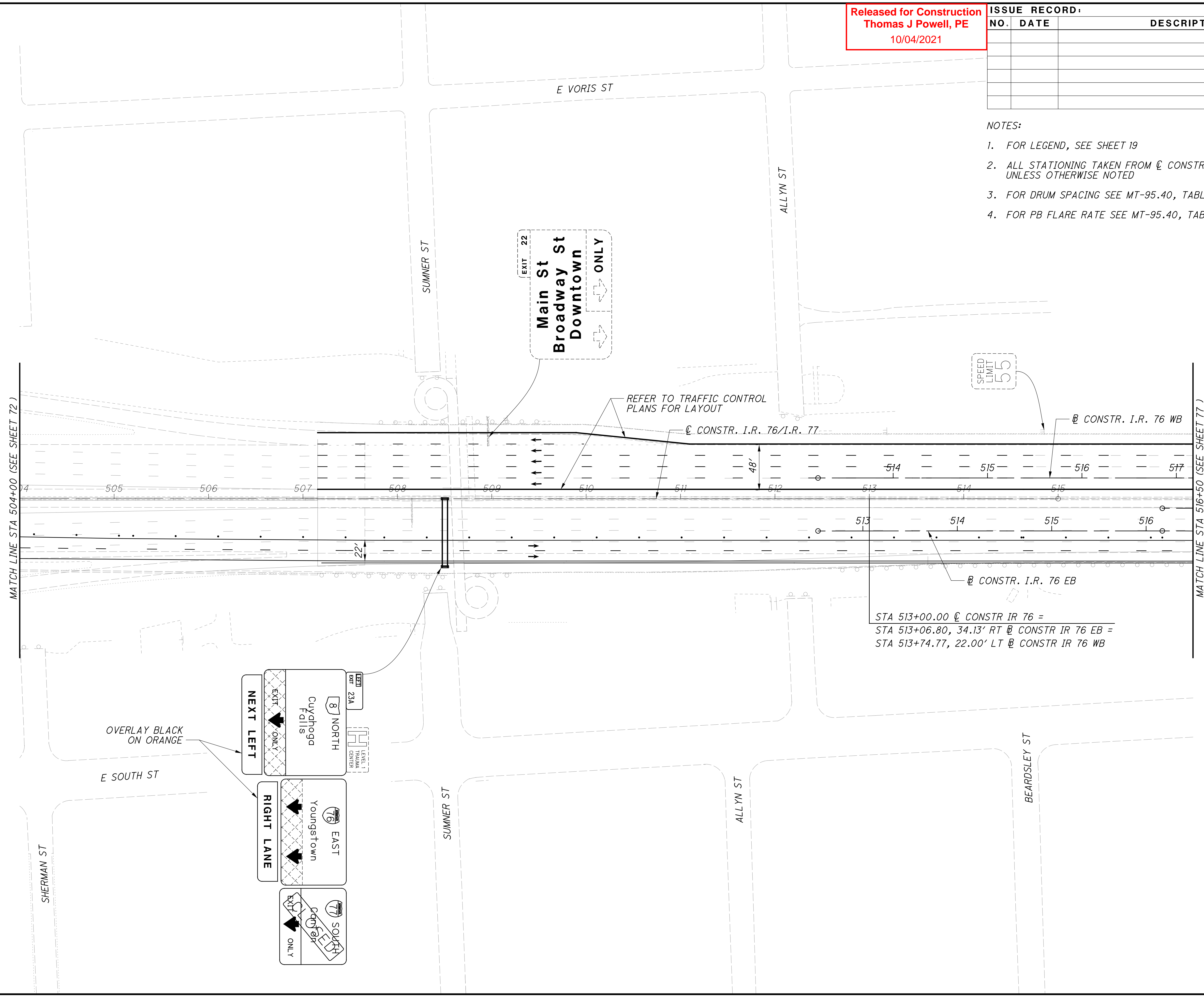

STA 513+00.00 \varnothing CONSTR IR 76 =
 STA 513+06.80, 34.13' RT \varnothing CONSTR IR 76 EB =
 STA 513+74.77, 22.00' LT \varnothing CONSTR IR 76 WB

OVERLAY BLACK ON ORANGE

RIGHT LANE

NEXT LEFT

EXIT 23A

EXIT 22

EXIT 77 SOUTH

EXIT 76 EAST

EXIT 8 NORTH

Youngstown

Cuyahoga Falls

LEVEL 1 TRAINING CENTER

2021-09-29 - BU 05 - RELEASED FOR CONSTRUCTION PLANS

MOT IR 76 / IR 77 PHASE 4B - STEP 2
 STA 504+00 TO STA 516+50

SUM-76 / 77 / 8-
 8.24 / 9.74 / 0.00

76
 105

d:\va\va01\p\wintol\parsons.com\Ohio State\Documents\DB-Akron Beltway Rehab\0 - Design\02329\MOT\Sheets\BU-05\02329_MPB054120.dgn Sheet 10/11/2021 6:52:10 AM apilipchuk

Released for Construction
 Thomas J Powell, PE
 10/04/2021

ISSUE RECORD:		
NO.	DATE	DESCRIPTION

- NOTES:
- FOR LEGEND SEE SHEET 19
 - ALL STATIONING TAKEN FROM @ CONSTRUCTION IR 76 EB UNLESS OTHERWISE NOTED
 - FOR DRUM SPACING SEE MT-95.40, TABLE II
 - FOR PB FLARE RATE SEE MT-95.40, TABLE II

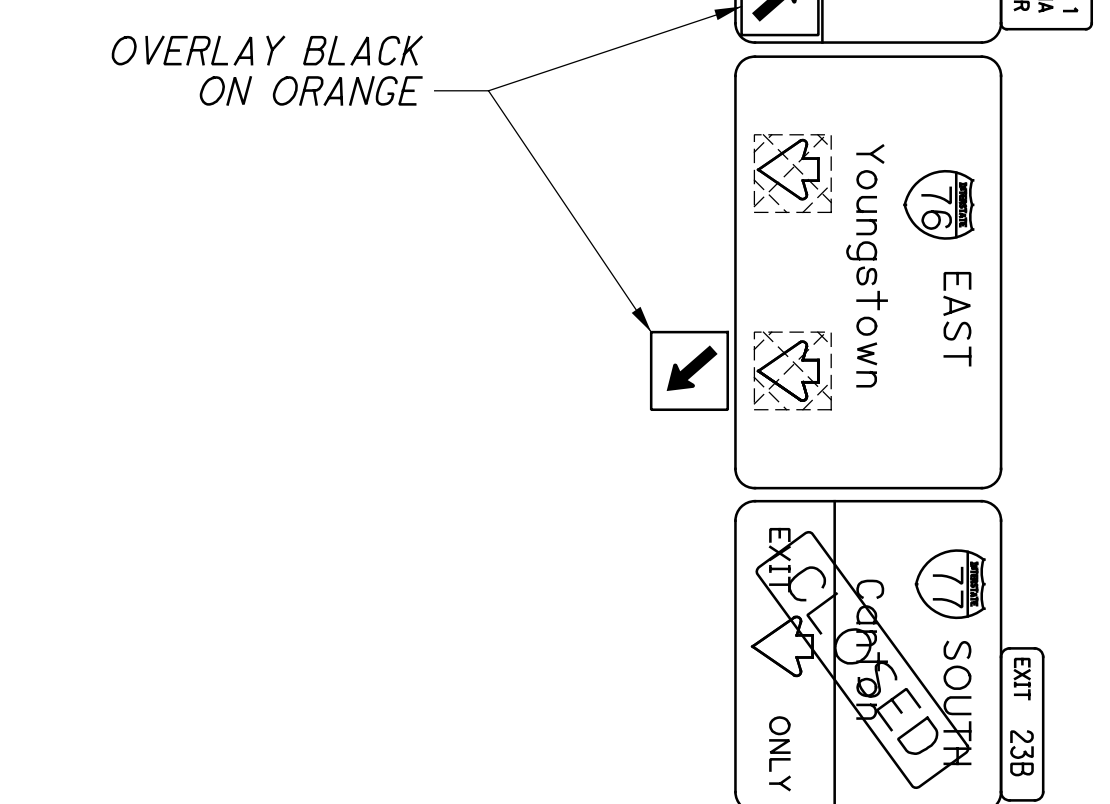
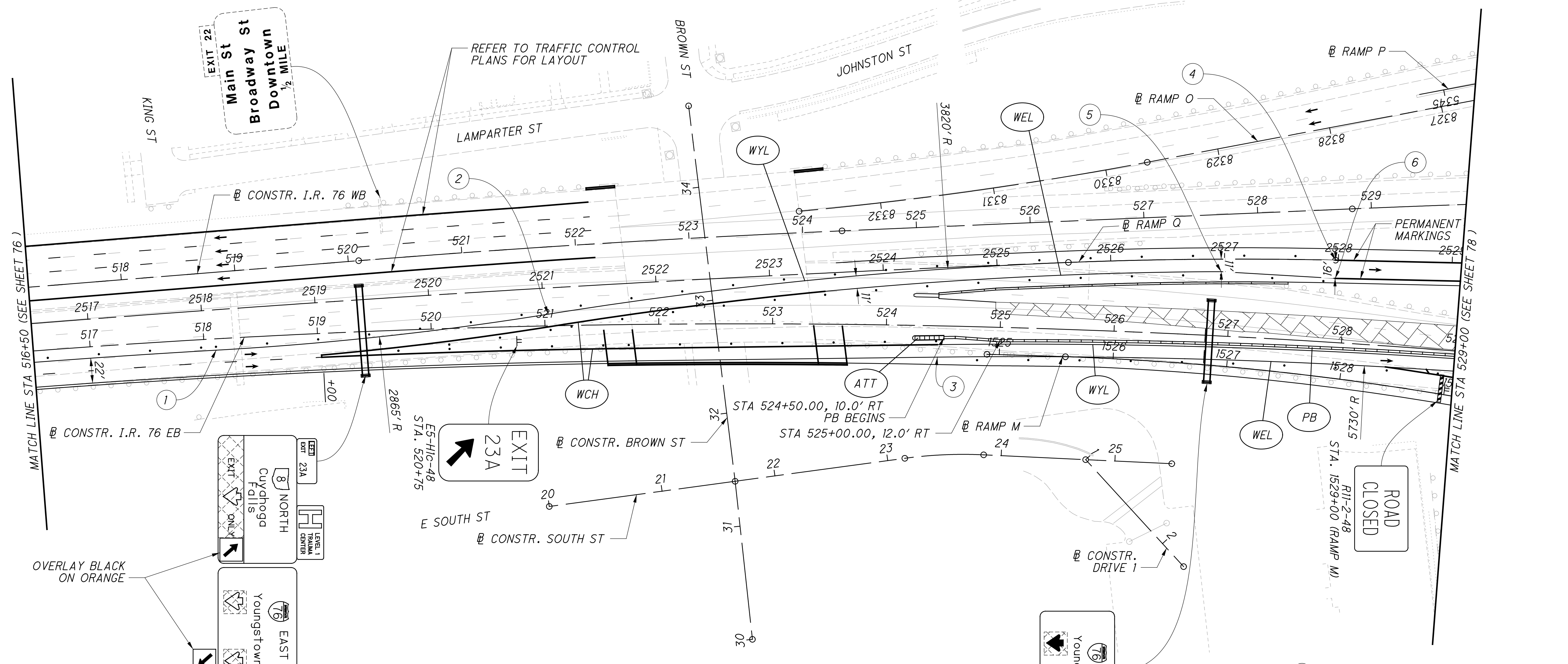

- ① - STA. 518+10.00, 10.0' RT PC
- ② - STA. 521+03.00, 10.0' LT PRC
- ③ - STA. 524+45.00, 27.5' RT PC
- ④ - STA. 2527+97.50, @ (RAMP Q) PT
- ⑤ - STA. 2526+97.50, 11.0' LT (RAMP Q) LANE TAPER BEGINS
- ⑥ - STA. 2528+97.50, 16.0' LT (RAMP Q) LANE TAPER ENDS

2021-09-29 - BU 05 - RELEASED FOR CONSTRUCTION PLANS

MOT IR 76 / IR 77 PHASE 4B - STEP 2
SUM-76 / 77 / 8-
8.24 / 9.74 / 0.00
STA 516+50 TO STA 529+00

dw:\VANVAOPWINTO\parsons.com:Ohio State\Documents\DB-Akron Beltway Rehab\0 - Design\02329\M0T\Sheets\BU-05\02329.MPB\BU5421.dgn Sheet 9/28/2021 10:07:16 PM aplipchuk

Released for Construction
 Thomas J Powell, PE
 10/04/2021

ISSUE RECORD:		
NO.	DATE	DESCRIPTION

- NOTES:
- FOR LEGEND SEE SHEET 19
 - ALL STATIONING TAKEN FROM CONSTRUCTION IR 76 EB UNLESS OTHERWISE NOTED
 - FOR DRUM SPACING SEE MT-95.40, TABLE II
 - FOR PB FLARE RATE SEE MT-95.40, TABLE II

CALCULATED VJ CHECKED AVP

0 50 100
 25
 HORIZONTAL SCALE IN FEET

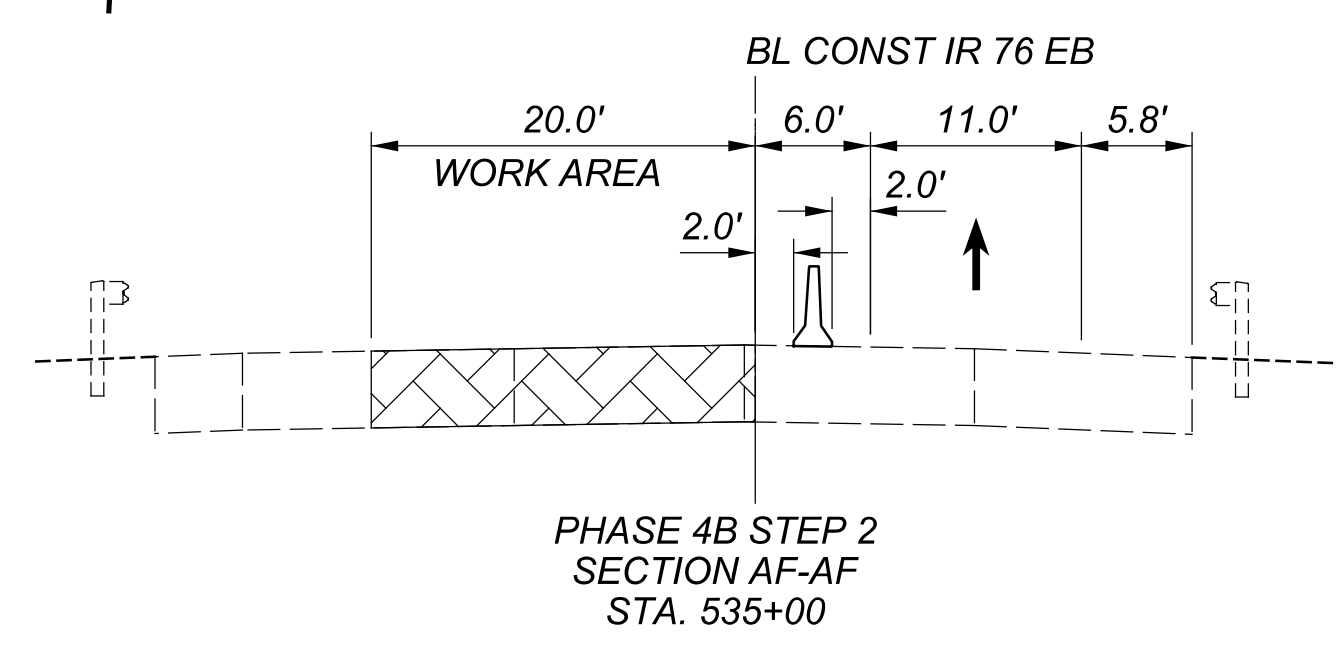
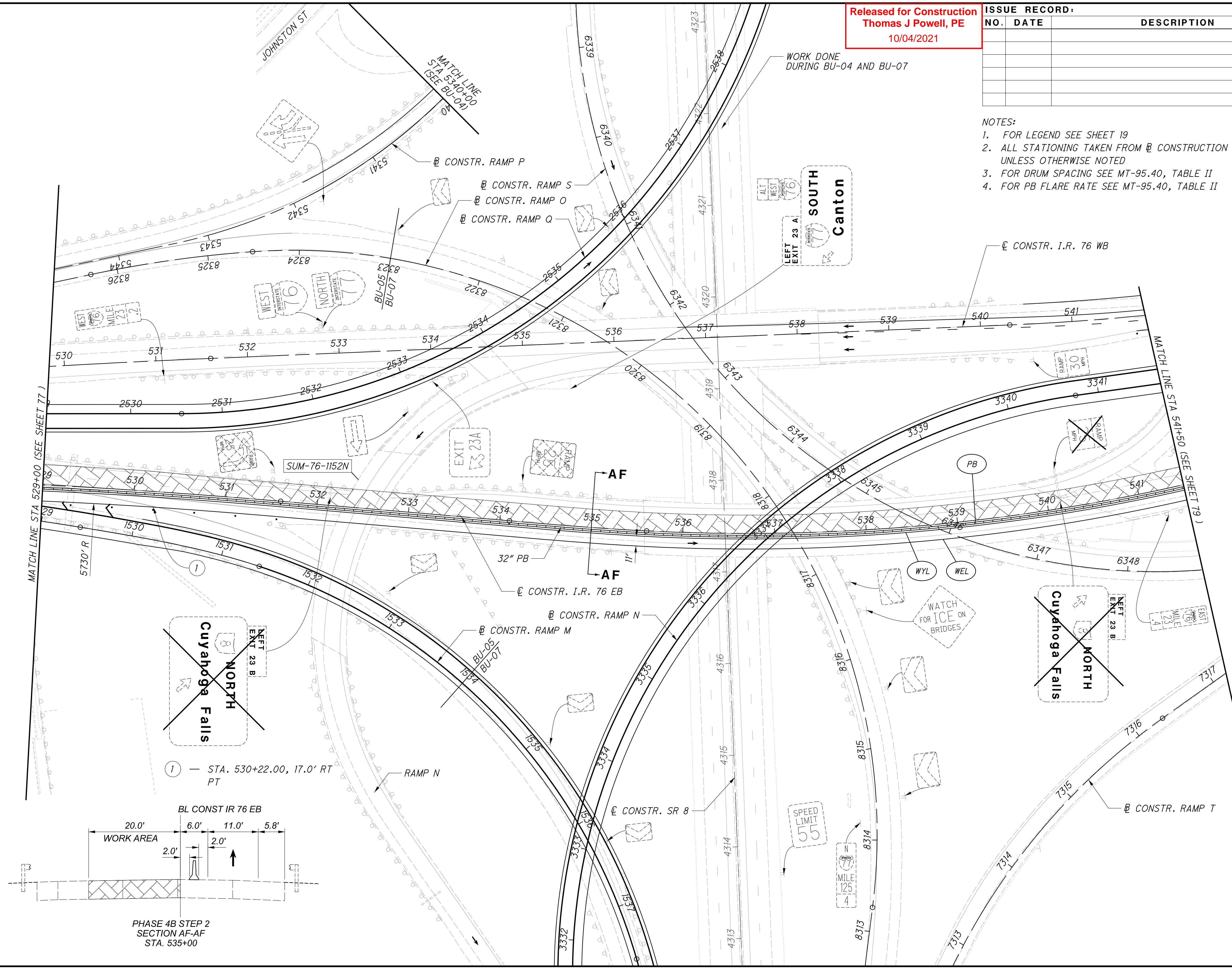

2021-09-29 - BU 05 - RELEASED FOR CONSTRUCTION PLANS

MOT IR 76 / IR 77 PHASE 4B - STEP 2
 SUM-76 / 77 / 8 -
 8.24 / 9.74 / 0.00

78
 105

d:\VANVAOP\WINTO\parsons.com\Ohio State\Documents\DB-Akron Beltway Rehab\0 - Design\02329\MOT\Sheets\BU-05\02329.MPB\BU54123.dgn Sheet 9/28/2021 10:34 PM aplilpchnuk

Released for Construction
 Thomas J Powell, PE
 10/04/2021

ISSUE RECORD:		
NO.	DATE	DESCRIPTION

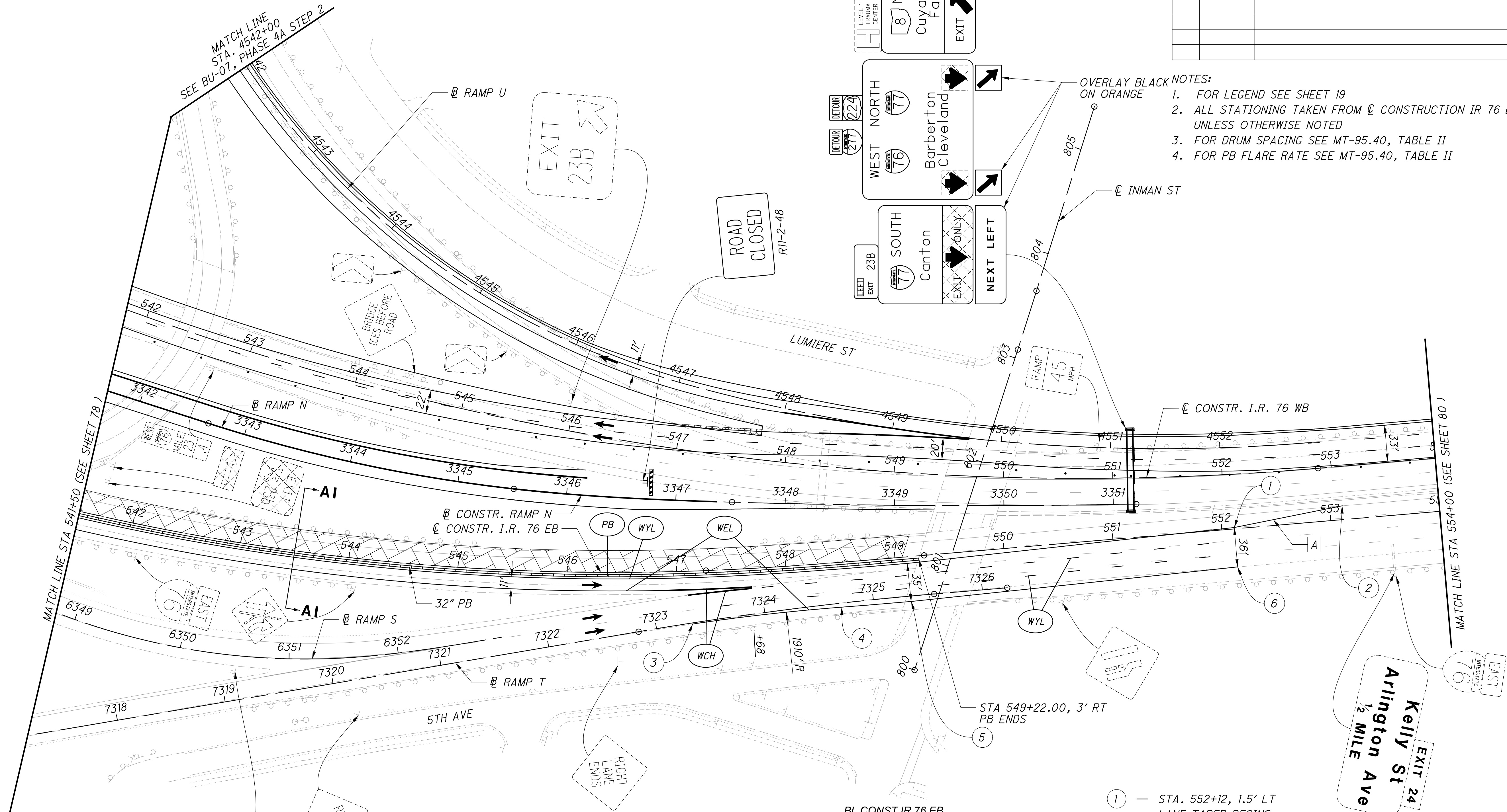
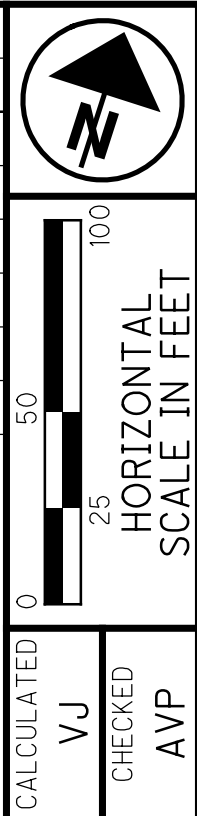

- OVERLAY BLACK NOTES:
 ON ORANGE
1. FOR LEGEND SEE SHEET 19
 2. ALL STATIONING TAKEN FROM \varnothing CONSTRUCTION IR 76 EB UNLESS OTHERWISE NOTED
 3. FOR DRUM SPACING SEE MT-95.40, TABLE II
 4. FOR PB FLARE RATE SEE MT-95.40, TABLE II

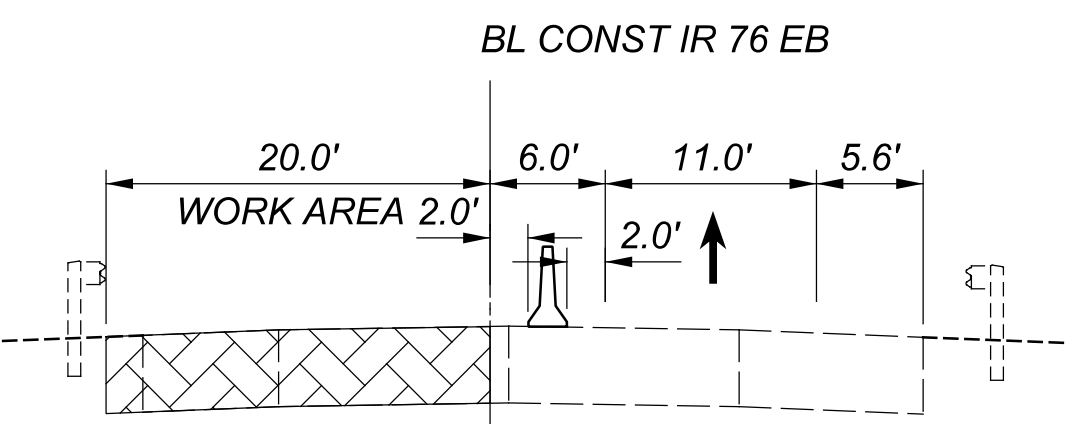

- ① — STA. 552+12, 1.5' LT LANE TAPER BEGINS
- ② — STA. 553+12, 12.5' LT LANE TAPER ENDS
- ③ — STA. 7323+33.00, 1.0' RT (RAMP T) PC
- ④ — STA. 7324+70.50, 3.7' RT (RAMP T) PT
- ⑤ — STA. 7325+34.50, 5.0' RT (RAMP T) LANE SHIFT/TAPER BEGINS
- ⑥ — STA. 552+11.50, 35.0' RT LANE SHIFT/TAPER ENDS

[A] - TAPERS USE 740.06 WORK ZONE PAVEMENT MARKING TYPE I (REMOVABLE)

2021-09-29 - BU 05 - RELEASED FOR CONSTRUCTION PLANS

MOT IR 76 / IR 77 PHASE 4B - STEP 2
 STA 541+50 TO STA 554+00

SUM-76/77/8-
 8.24/9.74.0.00

Released for Construction
 Thomas J Powell, PE
 10/04/2021

ISSUE RECORD:		
NO.	DATE	DESCRIPTION





 CALCULATED VJ
 CHECKED AVP

- NOTES:
- FOR LEGEND SEE SHEET 19
 - ALL STATIONING TAKEN FROM \varnothing CONSTRUCTION IR 76 WB UNLESS OTHERWISE NOTED
 - FOR DRUM SPACING SEE MT-95.40, TABLE II
 - FOR PB FLARE RATE SEE MT-95.40, TABLE II

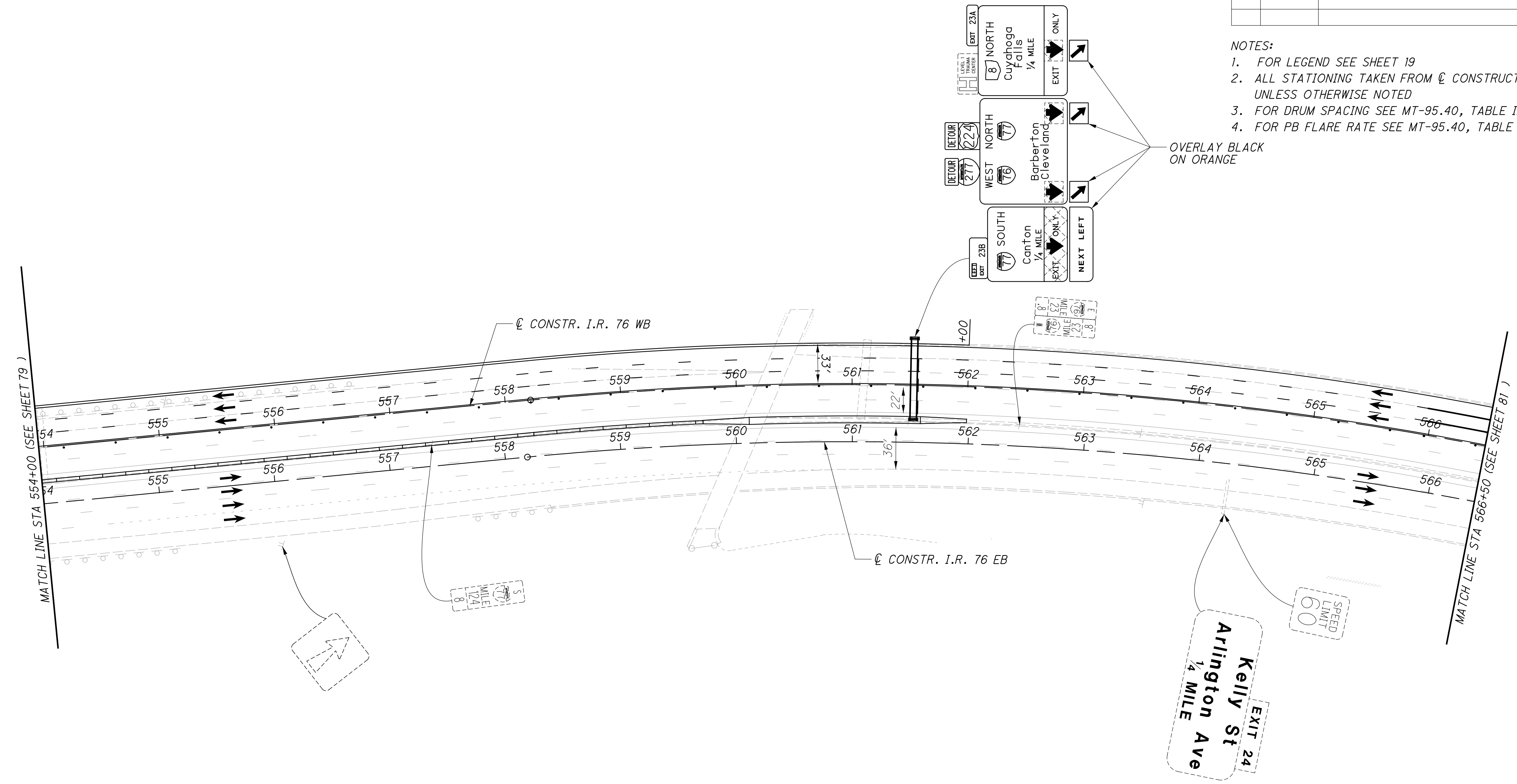

EXIT 23A
 NORTH
 Cuyahoga Falls
 1/4 MILE
 EXIT ONLY

DETOUR 22A
 NORTH
 77
 Barber-Ton
 Cleveland

WEST
 76
 Barber-Ton
 Cleveland

SOUTH
 77
 Canton
 1/4 MILE
 EXIT ONLY
 NEXT LEFT

EXIT 23B

OVERLAY BLACK ON ORANGE

Released for Construction
 Thomas J Powell, PE
 10/04/2021

ISSUE RECORD:		
NO.	DATE	DESCRIPTION

- NOTES:
- FOR LEGEND SEE SHEET 19
 - ALL STATIONING TAKEN FROM \varnothing CONSTRUCTION IR 76 WB UNLESS OTHERWISE NOTED
 - FOR DRUM SPACING SEE MT-95.40, TABLE II
 - FOR PB FLARE RATE SEE MT-95.40, TABLE II

CALCULATED VJ CHECKED AVP

HORIZONTAL SCALE IN FEET

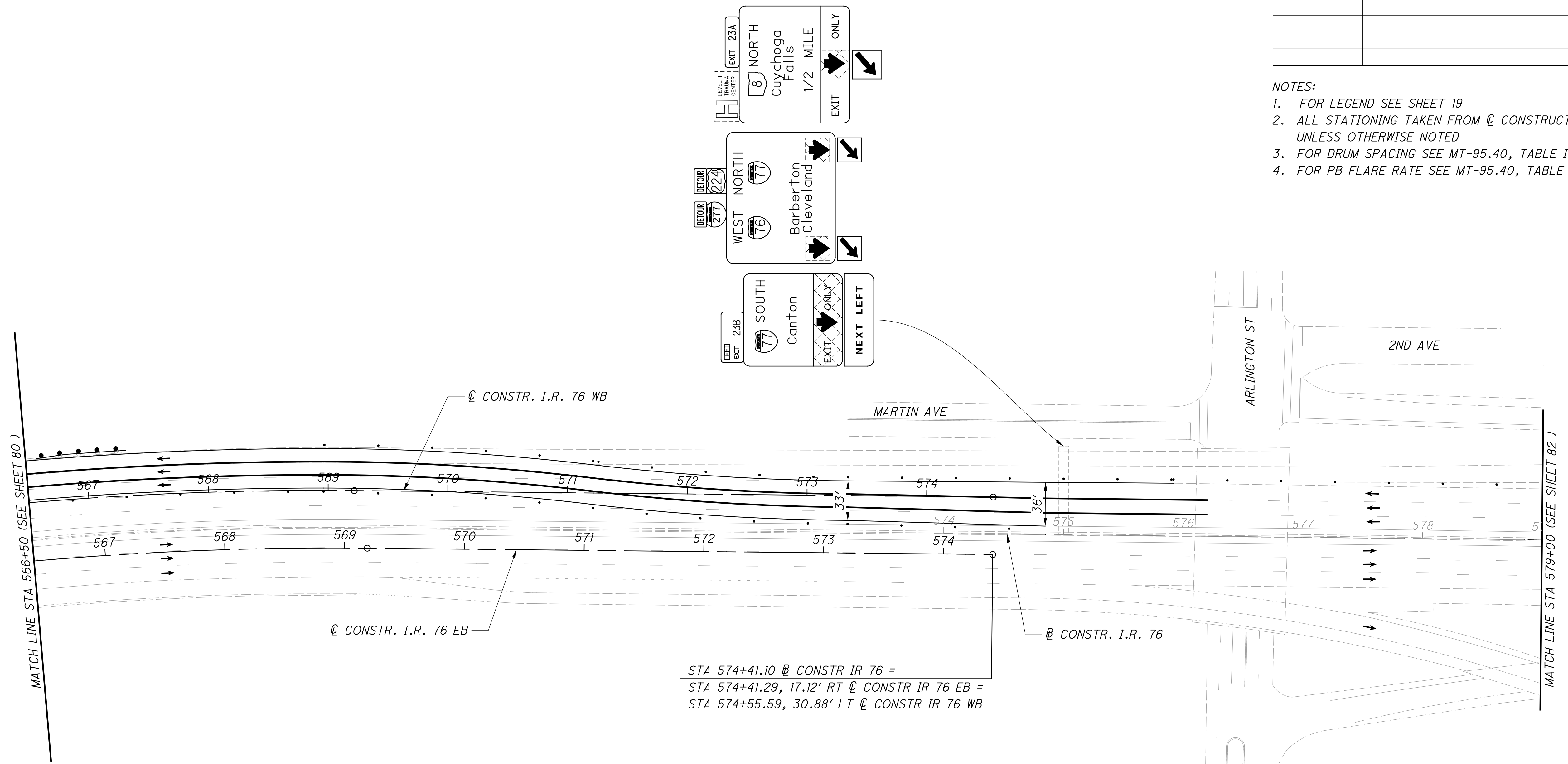

STA 574+41.10 \varnothing CONSTR IR 76 =
 STA 574+41.29, 17.12' RT \varnothing CONSTR IR 76 EB =
 STA 574+55.59, 30.88' LT \varnothing CONSTR IR 76 WB

pww:\VANVAOPWINTO\parsons.com:Ohio State\Documents\DB-Akron Beltway Rehab\10 - Design\02329\M0T\Sheets\BU-05\02329_MPBUS426.dgn Sheet 9/28/2021 10:07:58 PM apilipchuk

Released for Construction
 Thomas J Powell, PE
 10/04/2021

ISSUE RECORD:		
NO.	DATE	DESCRIPTION

- NOTES:
1. FOR LEGEND, SEE SHEET 19
 2. ALL STATIONING TAKEN FROM B CONSTRUCTION IR 76 UNLESS OTHERWISE NOTED
 3. FOR DRUM SPACING SEE MT-95.40, TABLE II
 4. FOR PB FLARE RATE SEE MT-95.40, TABLE II

0
100

25
 HORIZONTAL
 SCALE IN FEET

CALCULATED
VJ

CHECKED
AVP

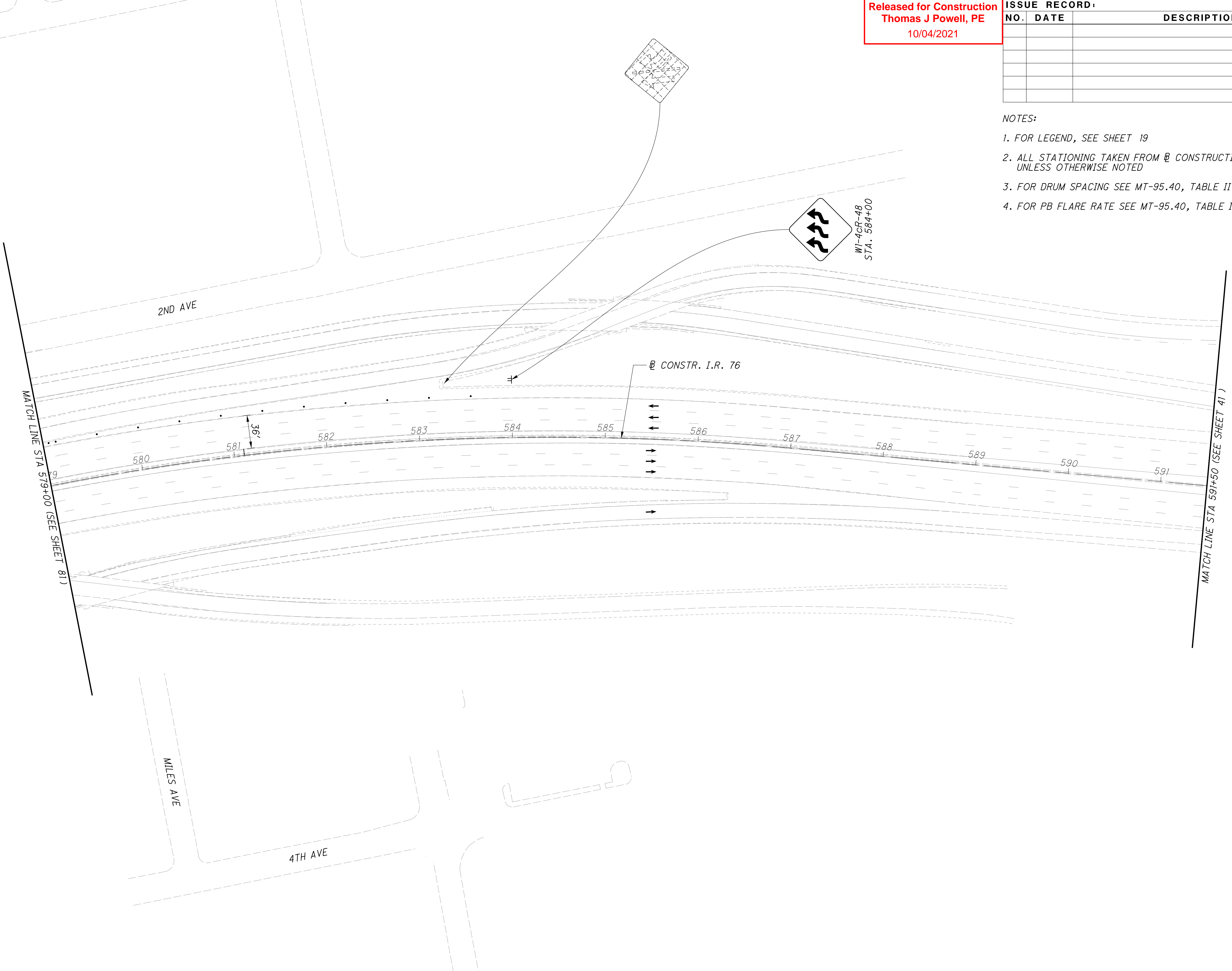

2021-09-29 - BU 05 - RELEASED FOR CONSTRUCTION PLANS

MOT IR 76 / IR 77 PHASE 4B STEP 2
 STA 579+00 TO STA 591+50

SUM-76 / 77 / 8-
 8.24 / 9.74 / 0.00

p:\ANV\A01P\WINT01\parsons.com\Ohio_State\Documents\DB-Akron Beltway Rehab\10 - Design\102329\MOT\Sheets\BU-05\102329_MPBUS507.dgn Sheet 9/28/2021 1:08:14 PM apilipchuk

Released for Construction
Thomas J Powell, PE
10/04/2021

ISSUE RECORD:		
NO.	DATE	DESCRIPTION

- NOTES:
- FOR LEGEND SEE SHEET 19
 - ALL STATIONING TAKEN FROM \varnothing CONSTRUCTION IR 77 UNLESS OTHERWISE NOTED
 - FOR DRUM SPACING SEE MT-95.40, TABLE II
 - FOR PB FLARE RATE SEE MT-95.40, TABLE II

CALCULATED
FGW
CHECKED
AVP

0 50 100
25
HORIZONTAL
SCALE IN FEET

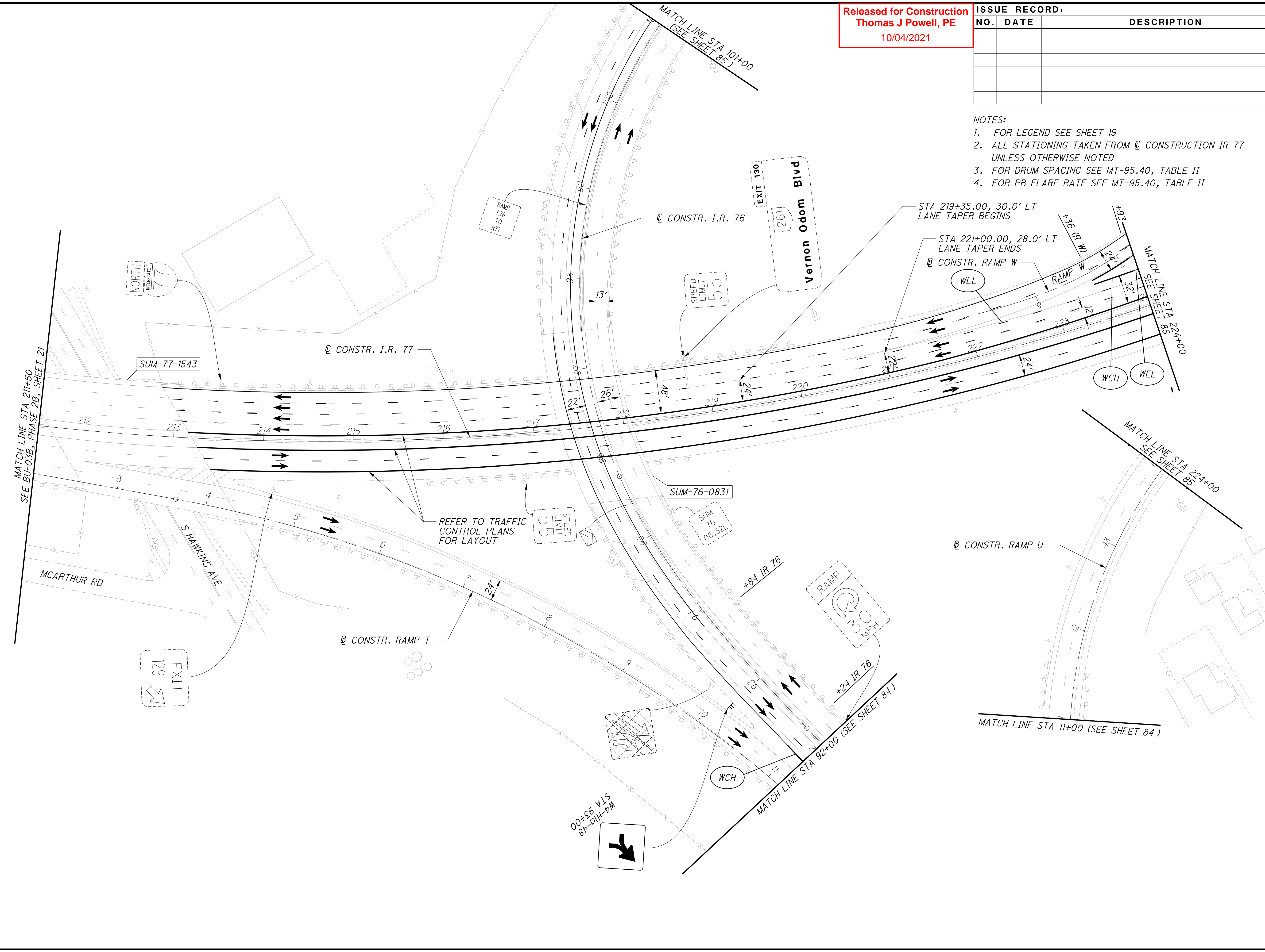

2021-09-29 - BU 05 - RELEASED FOR CONSTRUCTION PLANS

MOT IR 76 / IR 77 PHASE 5A - STEP 1
STA 211+50 TO STA 224+00

SUM-76 / 77 / 8-
8.24 / 9.74 / 0.00

pw:\VANVA01PWINT01\parsons.com\Ohio_State\Documents\Beltway_Akron\Rehab\10 - Design\102329\MOT\Sheets\BU-05\102329_MPBUS507A.dgn Sheet 9/28/2021 1:08:33 PM apilipchuk

Released for Construction
Thomas J Powell, PE
10/04/2021

ISSUE RECORD:		
NO.	DATE	DESCRIPTION

- NOTES:
1. FOR LEGEND SEE SHEET 19
 2. ALL STATIONING TAKEN FROM \varnothing CONSTRUCTION IR 76 UNLESS OTHERWISE NOTED
 3. FOR DRUM SPACING SEE MT-95.40, TABLE II
 4. FOR PB FLARE RATE SEE MT-95.40, TABLE II

100
25
0
50
HORIZONTAL SCALE IN FEET

CALCULATED
FGW
CHECKED
AVP

EXTRA ADVANCED WARNING SIGN - IR 76 EB

TYPE A WARNING LIGHT



ROAD WORK AHEAD

W20-1-48
W16-3aP-30
STA. (-)35+20

ADVANCED WARNING SIGNS - IR 76 EB

TYPE A WARNING LIGHT



ROAD WORK AHEAD

1 MILES

W20-1-48
W16-3aP-30
STA. 17+60

TYPE A WARNING LIGHT

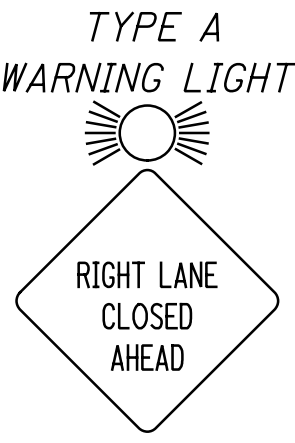

RIGHT LANE CLOSED AHEAD

W20-5-48
STA. 44+00

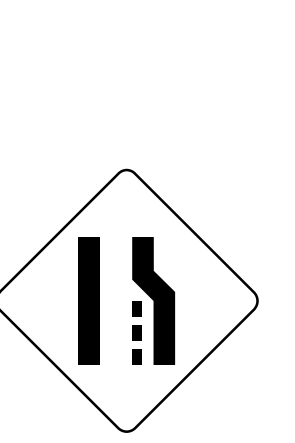

W4-2R-48
STA. 59+00

A — 740.06 WORK ZONE PAVEMENT MARKINGS, TYPE I

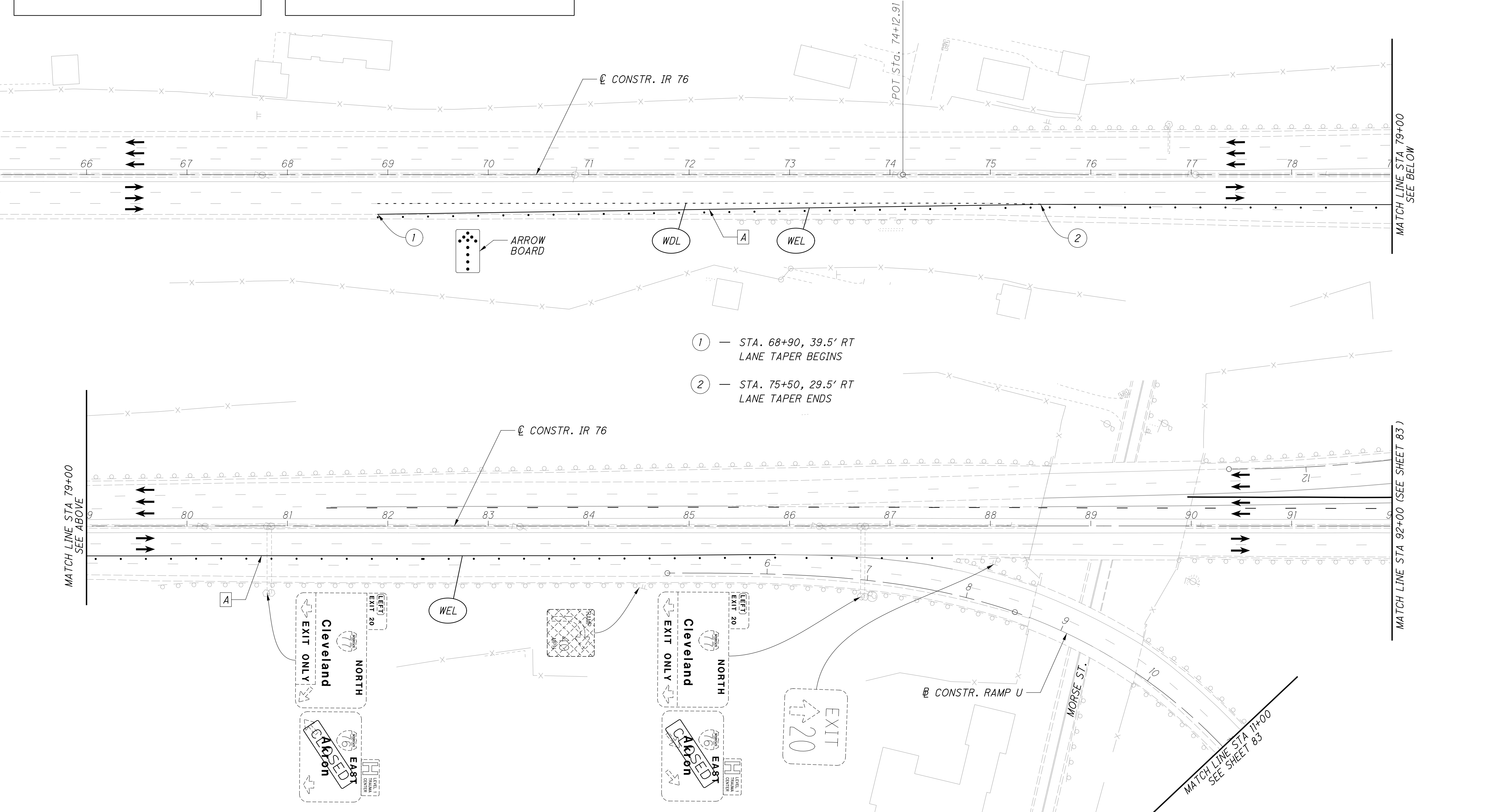

- ① — STA. 68+90, 39.5' RT LANE TAPER BEGINS
- ② — STA. 75+50, 29.5' RT LANE TAPER ENDS

2021-09-29 - BU 05 - RELEASED FOR CONSTRUCTION PLANS

MOT IR 76 PHASE 5A - STEP 1
STA 79+00 TO STA 92+00

SUM-76 / 77 / 8 -
8.24 / 9.74 / 0.00

84
105

pw:\VANVA01P\WINT01\parsons.com\Ohio_State\Documents\DB-Akron Beltway Rehab\10 - Design\102329\MOT\Sheets\BU-05\102329_MPB5508.dgn Sheet 9/28/2021 1:08:43 PM apilpichuk

Released for Construction
 Thomas J Powell, PE
 10/04/2021

ISSUE RECORD:		
NO.	DATE	DESCRIPTION

CALCULATED VJ
 CHECKED AVP

HORIZONTAL SCALE IN FEET

- NOTES:
- FOR LEGEND SEE SHEET 19
 - ALL STATIONING TAKEN FROM \varnothing CONSTRUCTION IR 77 UNLESS OTHERWISE NOTED
 - FOR DRUM SPACING SEE MT-95.40, TABLE II
 - FOR PB FLARE RATE SEE MT-95.40, TABLE II

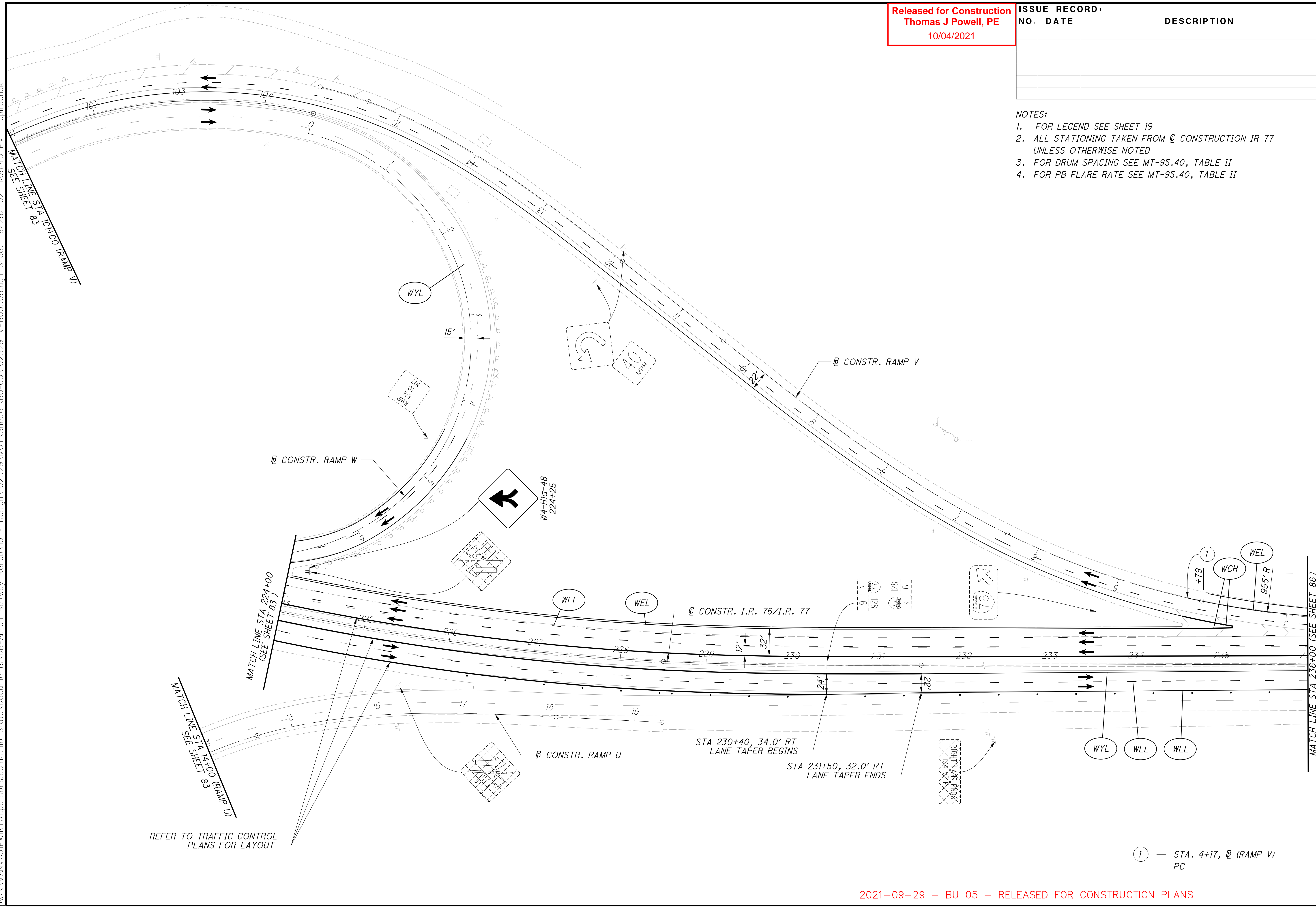

REFER TO TRAFFIC CONTROL PLANS FOR LAYOUT

① — STA. 4+17, \varnothing (RAMP V)
PC

MOT IR 76 / IR 77 PHASE 5A - STEP 1
 STA 224+00 TO STA 236+00

SUM-76 / 77 / 8 -
 8.24 / 9.74 / 0.00

85
105

NOTES:

1. FOR LEGEND SEE SHEET 19
2. ALL STATIONING TAKEN FROM CL CONSTRUCTION IR 76/IR 77 UNLESS OTHERWISE NOTED
3. FOR DRUM SPACING SEE MT-95.40, TABLE II
4. FOR PB FLARE RATE SEE MT-95.40, TABLE II

Released for Construction
 Thomas J Powell, PE
 10/04/2021

ISSUE RECORD:		
NO.	DATE	DESCRIPTION

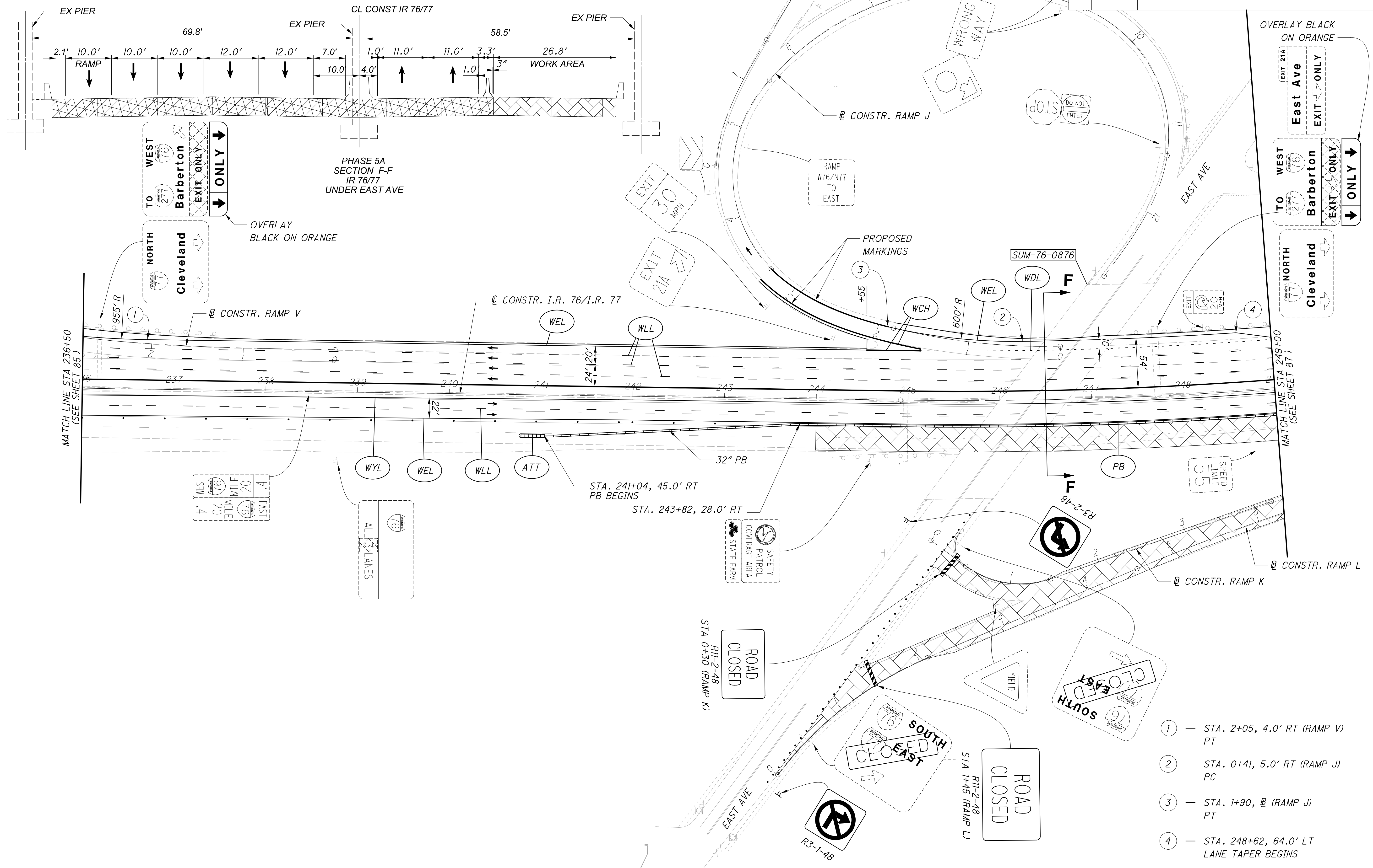
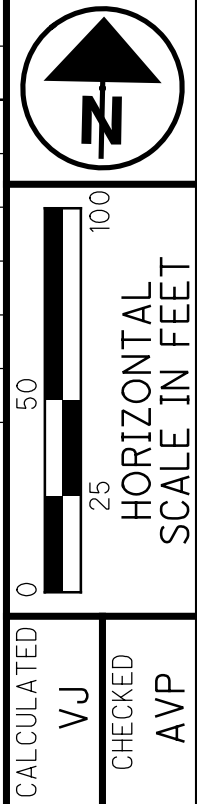

MATCH LINE STA 236+50
 (SEE SHEET 85)

MATCH LINE STA 249+00
 (SEE SHEET 87)

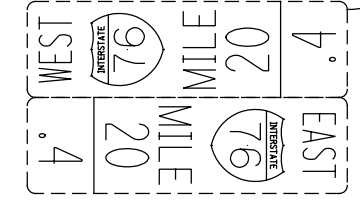

- ① — STA. 2+05, 4.0' RT (RAMP V) PT
- ② — STA. 0+41, 5.0' RT (RAMP J) PC
- ③ — STA. 1+90, CL (RAMP J) PT
- ④ — STA. 248+62, 64.0' LT LANE TAPER BEGINS

pw:\VANVA01P\WINT01\parsons.com\Ohio State\Documents\DB-Akron Beltway Rehab\10 - Design\102329\MOT\Sheets\BU-05\102329_MPBUS509.dgn Sheet 9/28/2021 1:08:52 PM aplipchuk

2021-09-29 - BU 05 - RELEASED FOR CONSTRUCTION PLANS

MOT IR 76 / IR 77 PHASE 5A - STEP 1
 STA 236+50 TO STA 249+00

SUM-76 / 77 / 8 -
 8.24 / 9.74 / 0.00

86
 105

pw:\VANVA01PWINT01.parsons.com:Ohio State Documents\DB-Akron Beltway Rehab\10 - Design\102329\MOT\Sheets\BU-05\102329_MPB05510.dgn Sheet 9/28/2021 1:08:59 PM apilipchuk

Released for Construction
 Thomas J Powell, PE
 10/04/2021

ISSUE RECORD:		
NO.	DATE	DESCRIPTION

- NOTES:
- FOR LEGEND SEE SHEET 19
 - ALL STATIONING TAKEN FROM ϕ CONSTRUCTION IR 76/IR 77 UNLESS OTHERWISE NOTED
 - FOR DRUM SPACING SEE MT-95.40, TABLE II
 - FOR PB FLARE RATE SEE MT-95.40, TABLE II

CALCULATED
 VJ
 CHECKED
 AVP

0 50 100
 HORIZONTAL
 SCALE IN FEET

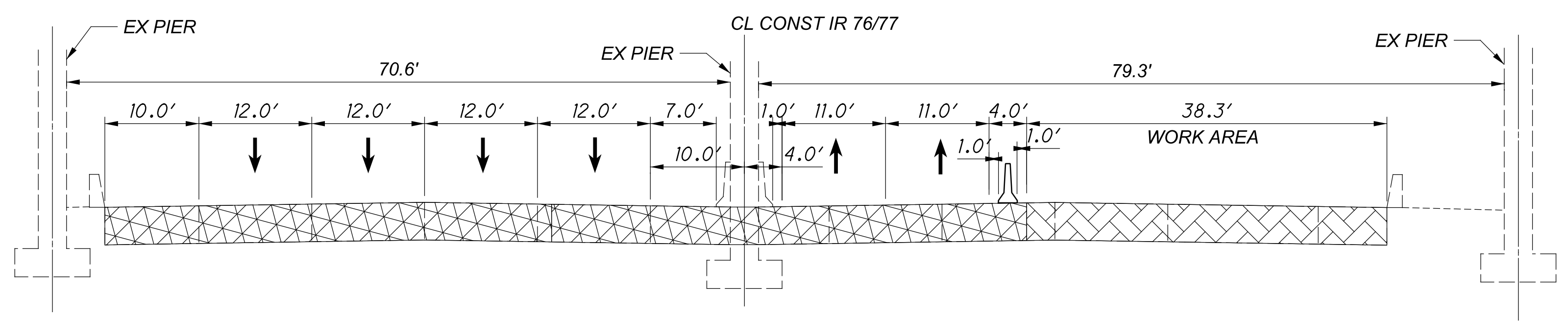
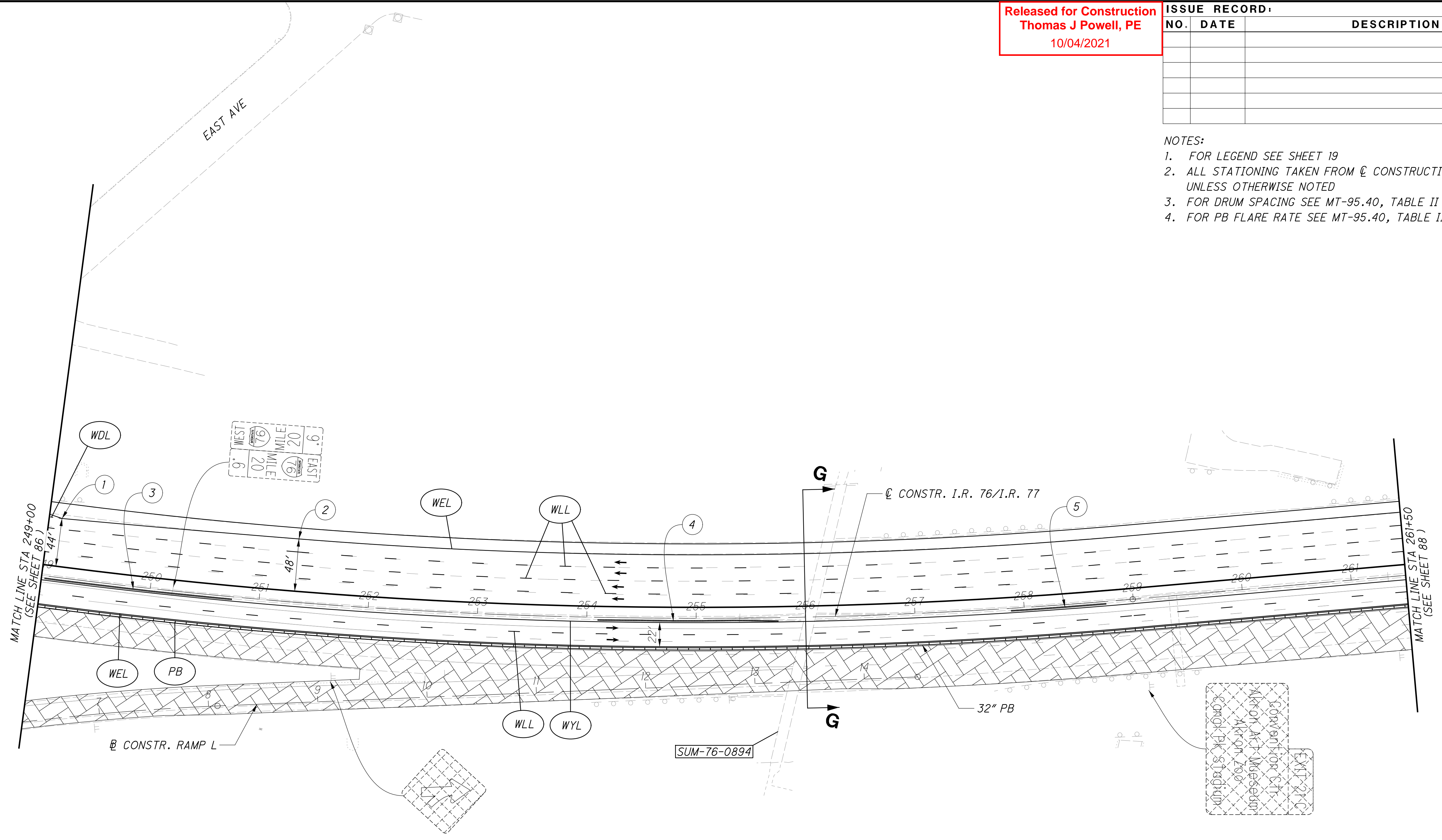

PHASE 5A
 SECTION G-G
 IR 76/77
 UNDER HILLCREST PEDESTRIAN BRIDGE

- STA. 249+12, 54.0' RT
 LANE TAPER ENDS
 LANE TAPER BEGINS
- STA. 249+12, 54.0' RT
 LANE TAPER ENDS
- TROUGH, WIDTH - 12.0", DEPTH - 1.5", LENGTH 172'
 BEGIN STA. 249+03
 END STA. 250+75
- TROUGH, WIDTH - 15.5", DEPTH - 1.5", LENGTH 165'
 BEGIN STA. 254+10
 END STA. 255+75
- TROUGH, WIDTH - 14.5", DEPTH - 1.5", LENGTH 87'
 BEGIN STA. 257+88
 END STA. 258+75

2021-09-29 - BU 05 - RELEASED FOR CONSTRUCTION PLANS

MOT IR 76 / IR 77 PHASE 5A - STEP 1
 STA. 249+00 TO STA 261+50

SUM-76 / 77 / 8-
 8.24 / 9.74 / 0.00

p:\VANVAOPWINTO\parsons.com\Ohio State\Documents\Beltway Rehab\10 - Design\02329\MOT\Sheets\BU-05\02329_MPBUS55\l.dgn Sheet 9/28/2021 10:09:06 PM apilpchnuk

Released for Construction
 Thomas J Powell, PE
 10/04/2021

ISSUE RECORD:		
NO.	DATE	DESCRIPTION

NOTES:
 1. FOR LEGEND SEE SHEET 19
 2. ALL STATIONING TAKEN FROM \varnothing CONSTRUCTION IR 76/IR 77 UNLESS OTHERWISE NOTED
 3. FOR DRUM SPACING SEE MT-95.40, TABLE II
 4. FOR PB FLARE RATE SEE MT-95.40, TABLE II

CALCULATED VJ
 CHECKED AVP

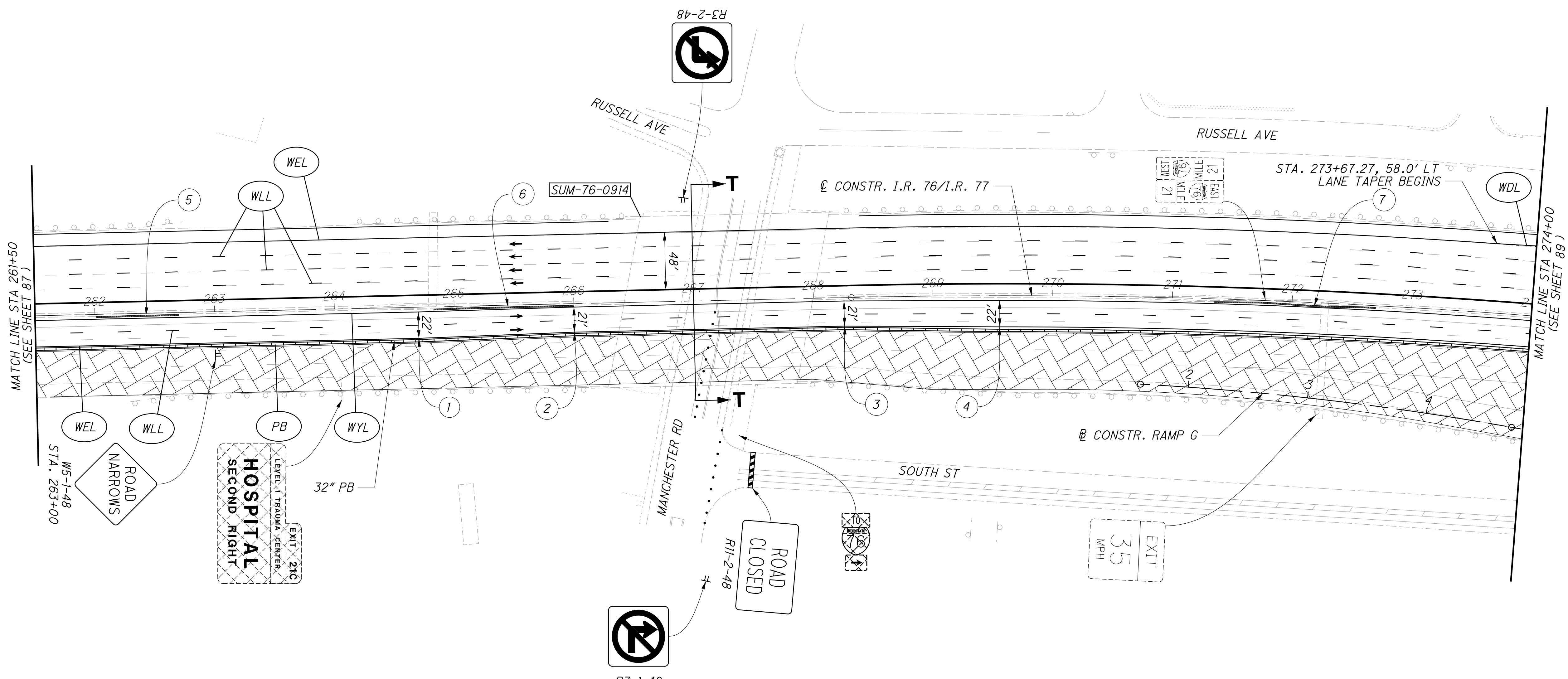

- 5 — TROUGH, WIDTH - 9.0", DEPTH - 1.5", LENGTH 69'
 BEGIN STA. 262+01
 END STA. 262+70
- 6 — TROUGH, WIDTH - 13.5", DEPTH - 1.5", LENGTH 117'
 BEGIN STA. 264+83
 END STA. 266+00
- 7 — TROUGH, WIDTH - 7.0", DEPTH - 1.5", LENGTH 135'
 BEGIN STA. 271+35
 END STA. 272+70

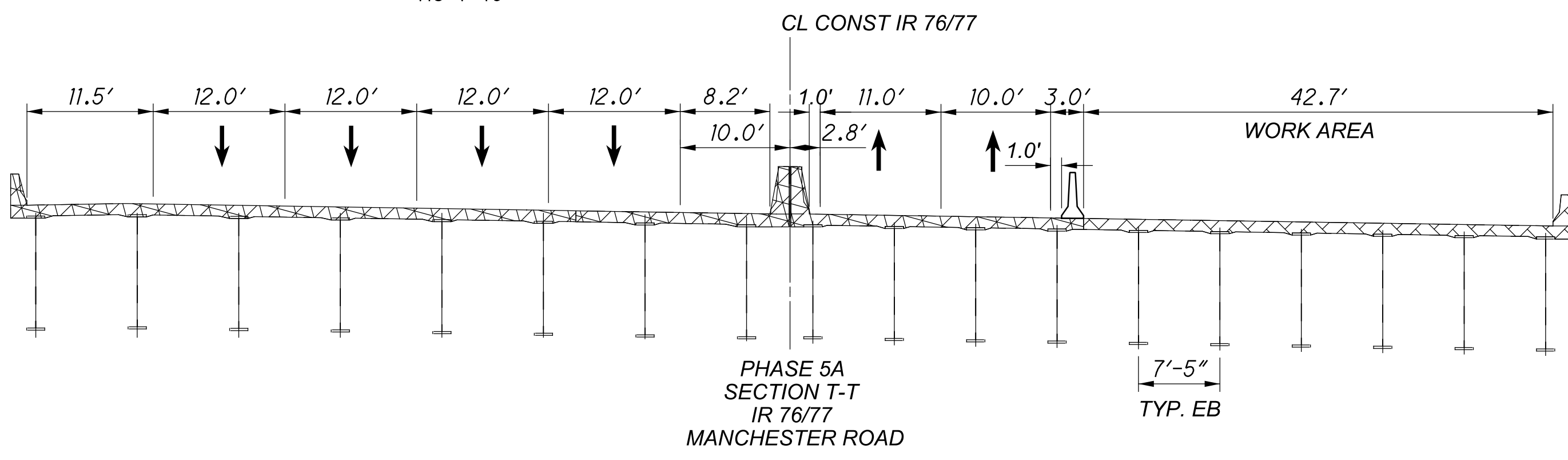

- 1 — STA. 264+70, 26.0' RT LANE SHIFT BEGINS
- 2 — STA. 266+00, 24.0' RT LANE SHIFT ENDS
- 3 — STA. 268+26, 24.0' RT LANE SHIFT BEGINS
- 4 — STA. 269+56, 26.0' RT LANE SHIFT ENDS

2021-09-29 - BU 05 - RELEASED FOR CONSTRUCTION PLANS

MOT IR 76 / IR 77 PHASE 5A - STEP 1
 STA 261+50 TO STA 274+00

SUM-76/77/8-
 8.24/9.74/0.00

d:\VANVAOPWINTO\parsons.com\Ohio State\Documents\DB-Akron Beltway Rehab\10 - Design\102329\MOT\Sheets\BU-05\102329_MPB05512.dgn Sheet 9/28/2021 10:09:13 PM apilipchuk

Released for Construction
Thomas J Powell, PE
10/04/2021

ISSUE RECORD:		
NO.	DATE	DESCRIPTION

- NOTES:
- FOR LEGEND SEE SHEET 19
 - ALL STATIONING TAKEN FROM \odot CONSTRUCTION IR 76/IR 77 UNLESS OTHERWISE NOTED
 - FOR DRUM SPACING SEE MT-95.40, TABLE II
 - FOR PB FLARE RATE SEE MT-95.40, TABLE II

CALCULATED
V J
CHECKED
AVP

0 50 100
25
HORIZONTAL
SCALE IN FEET

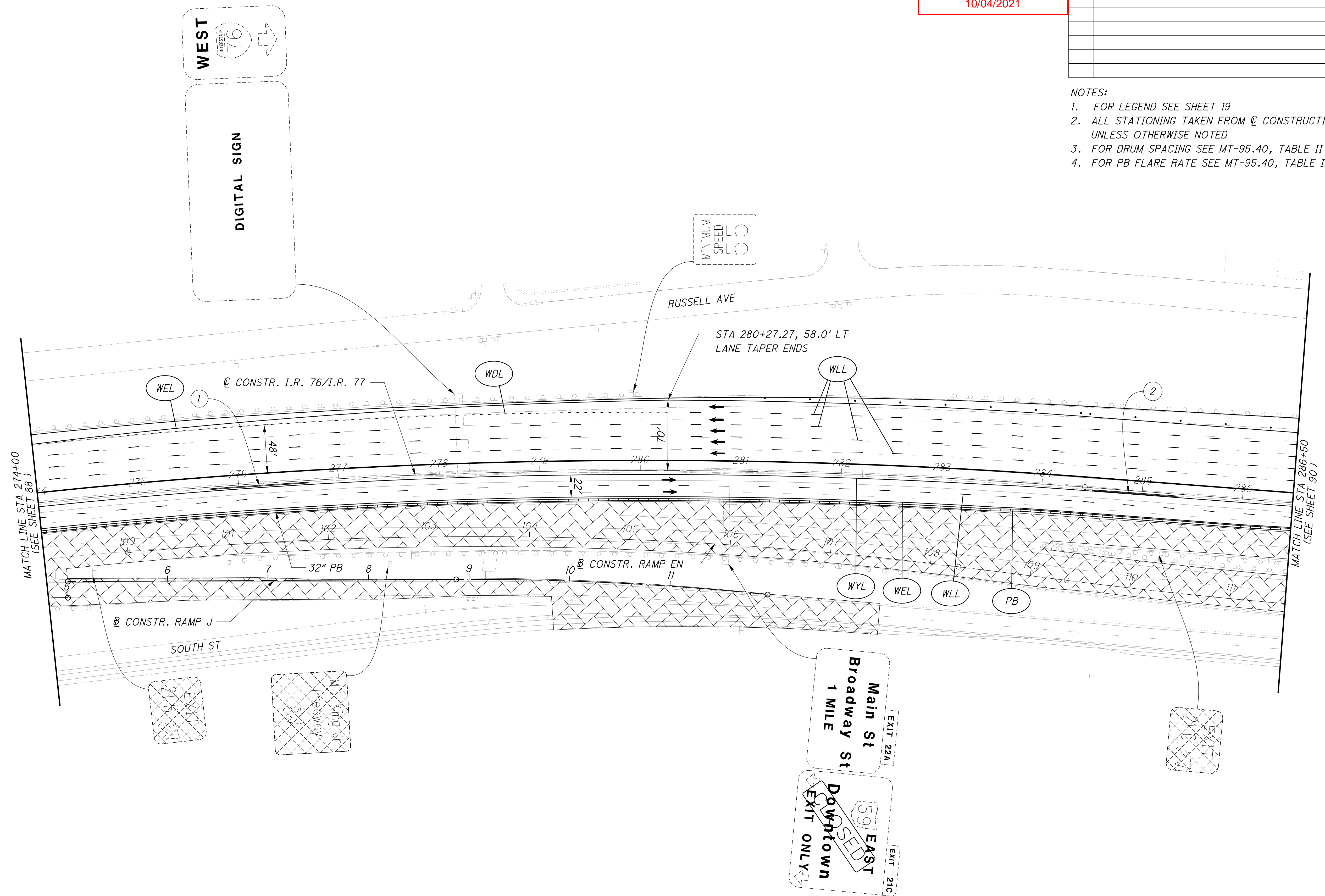

- ① — TROUGH, WIDTH - 7.5", DEPTH - 1.0", LENGTH 98'
BEGIN STA. 275+72
END STA. 276+70
- ② — TROUGH, WIDTH - 8.0", DEPTH - 1.0", LENGTH 86'
BEGIN STA. 285+36
END STA. 284+50

2021-09-29 - BU 05 - RELEASED FOR CONSTRUCTION PLANS

MOT IR 76 / IR 77 PHASE 5A - STEP 1
STA 274+00 TO STA 286+50

SUM-76/77/8-
8.24/9.74/0.00

89
105

pw:\VANVAOPWINTO\parsons.com:Ohio State\Documents\Beltway Rehab\10 - Design\02329\MOT\Sheets\BU-05\02329_MPB05513.dgn Sheet 9/28/2021 2:19:32 PM aplipchuk

Released for Construction
 Thomas J Powell, PE
 10/04/2021

ISSUE RECORD:		
NO.	DATE	DESCRIPTION

- NOTES:
- FOR LEGEND SEE SHEET 19
 - ALL STATIONING TAKEN FROM CL CONSTRUCTION IR 76/IR 77 UNLESS OTHERWISE NOTED
 - FOR DRUM SPACING SEE MT-95.40, TABLE II
 - FOR PB FLARE RATE SEE MT-95.40, TABLE II

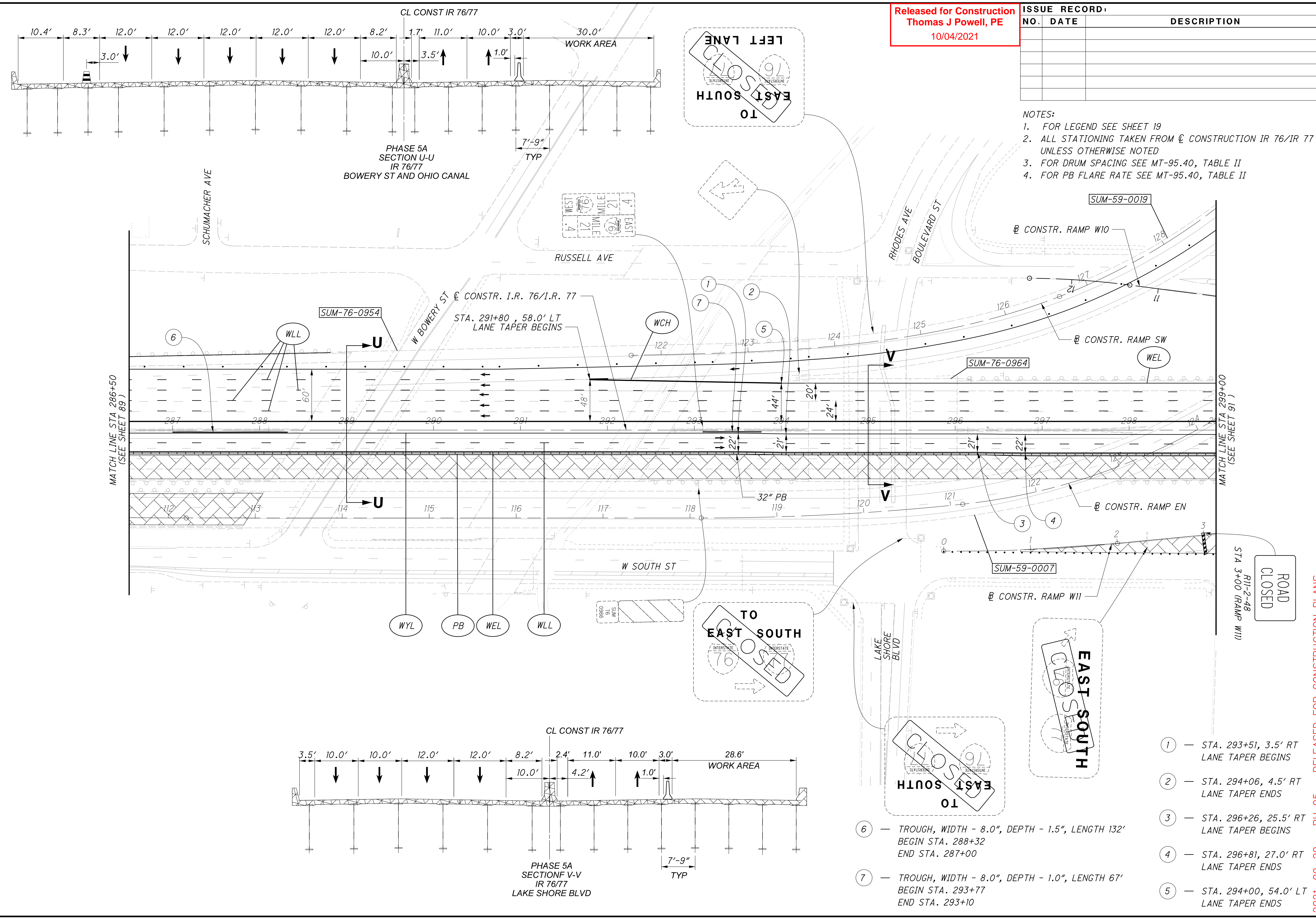

MOT IR 76 / IR 77 PHASE 5A - STEP 1
 STA 286+50 TO STA 299+00
 SUM-76/77/8-8.24/9.74/0.00
 2021-09-29 - BU 05 - RELEASED FOR CONSTRUCTION PLANS

- ① - STA. 293+51, 3.5' RT LANE TAPER BEGINS
- ② - STA. 294+06, 4.5' RT LANE TAPER ENDS
- ③ - STA. 296+26, 25.5' RT LANE TAPER BEGINS
- ④ - STA. 296+81, 27.0' RT LANE TAPER ENDS
- ⑤ - STA. 294+00, 54.0' LT LANE TAPER ENDS
- ⑥ - TROUGH, WIDTH - 8.0", DEPTH - 1.5", LENGTH 132' BEGIN STA. 288+32 END STA. 287+00
- ⑦ - TROUGH, WIDTH - 8.0", DEPTH - 1.0", LENGTH 67' BEGIN STA. 293+77 END STA. 293+10

90/105

d:\va\vaopwintol\parsons.com\Ohio State\Documents\DB-Akron Beltway Rehab\10 - Design\02329\M0T\Sheets\BU-05\02329_MPB05514.dgn Sheet 9/28/2021 09:27 PM aplipchuk

Released for Construction
 Thomas J Powell, PE
 10/04/2021

ISSUE RECORD:		
NO.	DATE	DESCRIPTION

- NOTES:
- FOR LEGEND SEE SHEET 19
 - ALL STATIONING TAKEN FROM CL CONSTRUCTION IR 76/IR 77 UNLESS OTHERWISE NOTED
 - FOR DRUM SPACING SEE MT-95.40, TABLE II
 - FOR PB FLARE RATE SEE MT-95.40, TABLE II

CALCULATED VJ
 CHECKED AVP

0 50 100
 HORIZONTAL SCALE IN FEET

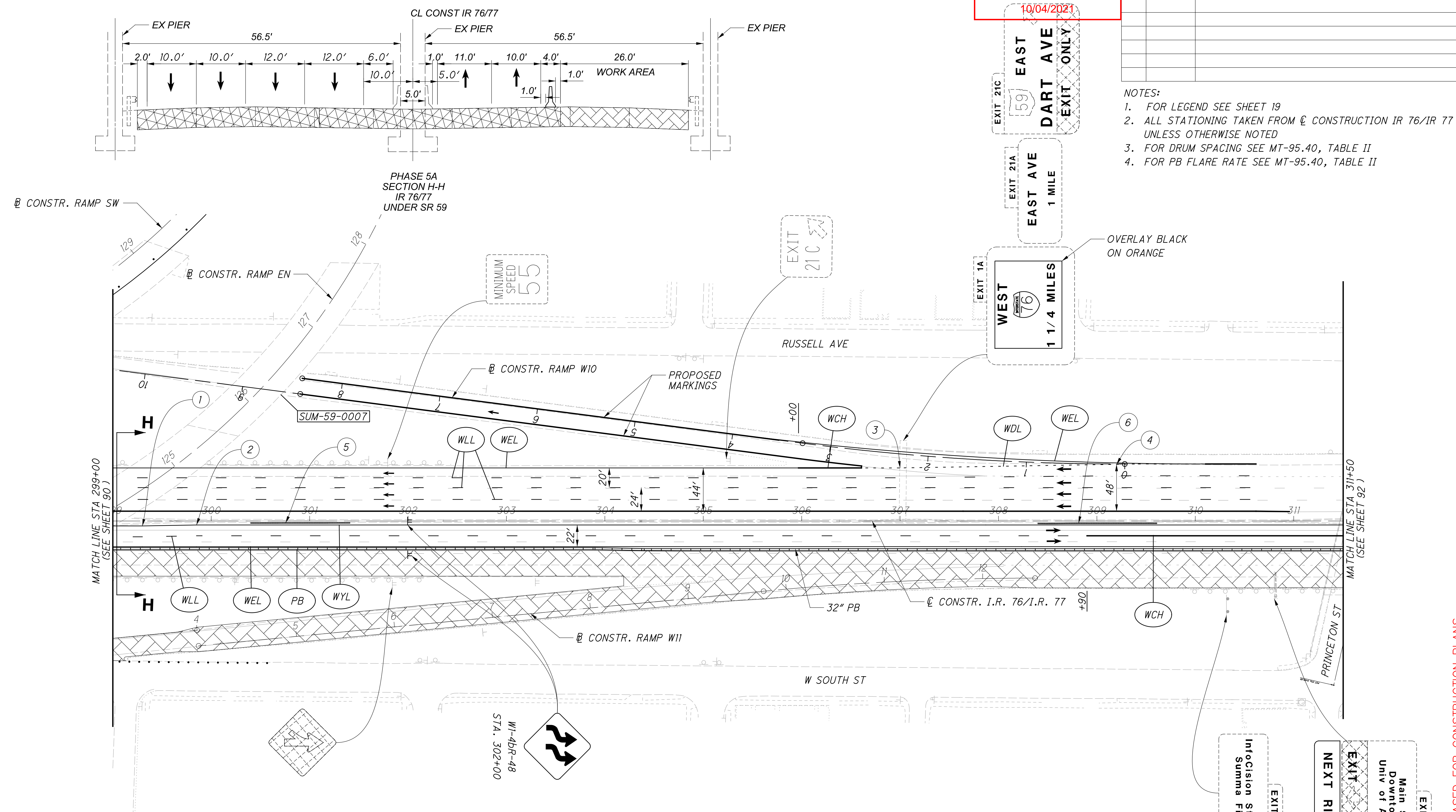

- ① — STA. 299+30, 5.0' RT LANE SHIFT BEGINS
- ② — STA. 299+85, 4.0' RT LANE SHIFT ENDS
- ③ — STA. 307+00, 54.0' LT LANE TAPER BEGINS
- ④ — STA. 308+90, 58.0' LT LANE TAPER ENDS
- ⑤ — TROUGH, WIDTH - 7.0", DEPTH - 1.5", LENGTH 101' BEGIN STA. 301+41 END STA. 300+40
- ⑥ — TROUGH, WIDTH - 6.5", DEPTH - 1.5", LENGTH 121' BEGIN STA. 309+61 END STA. 308+40

2021-09-29 - BU 05 - RELEASED FOR CONSTRUCTION PLANS

MOT IR 76 / IR 77 PHASE 5A - STEP 1
 STA 299+00 TO STA 311+50

SUM-76 / 77 / 8-
 8.24 / 9.74 / 0.00

pw:\VANVAOPWINTO\parsons.com:Ohio State\Documents\DB-Akron Beltway Rehab\0 - Design\02329\M0T\Sheets\BU-05\02329_MPBUS5515.dgn_Sheet 9/28/2021 09:34 PM aplipchuk

Released for Construction
 Thomas J Powell, PE
 10/04/2021

ISSUE RECORD:		
NO.	DATE	DESCRIPTION

- NOTES:
- FOR LEGEND SEE SHEET 19
 - ALL STATIONING TAKEN FROM CL CONSTRUCTION IR 76/IR 77 UNLESS OTHERWISE NOTED
 - FOR DRUM SPACING SEE MT-95.40, TABLE II
 - FOR PB FLARE RATE SEE MT-95.40, TABLE II

HORIZONTAL SCALE IN FEET

CHECKED AVP

CALCULATED VJ

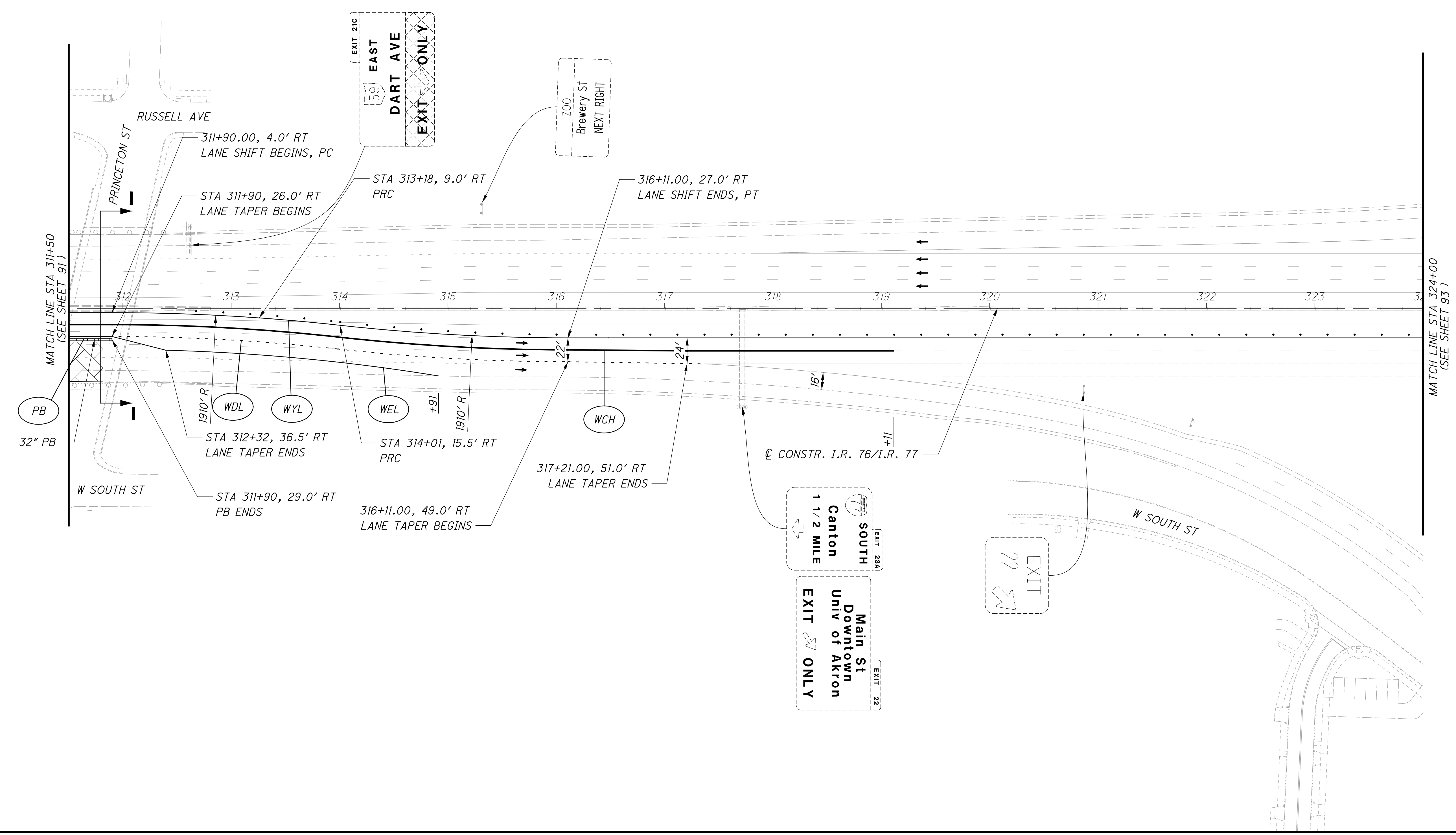
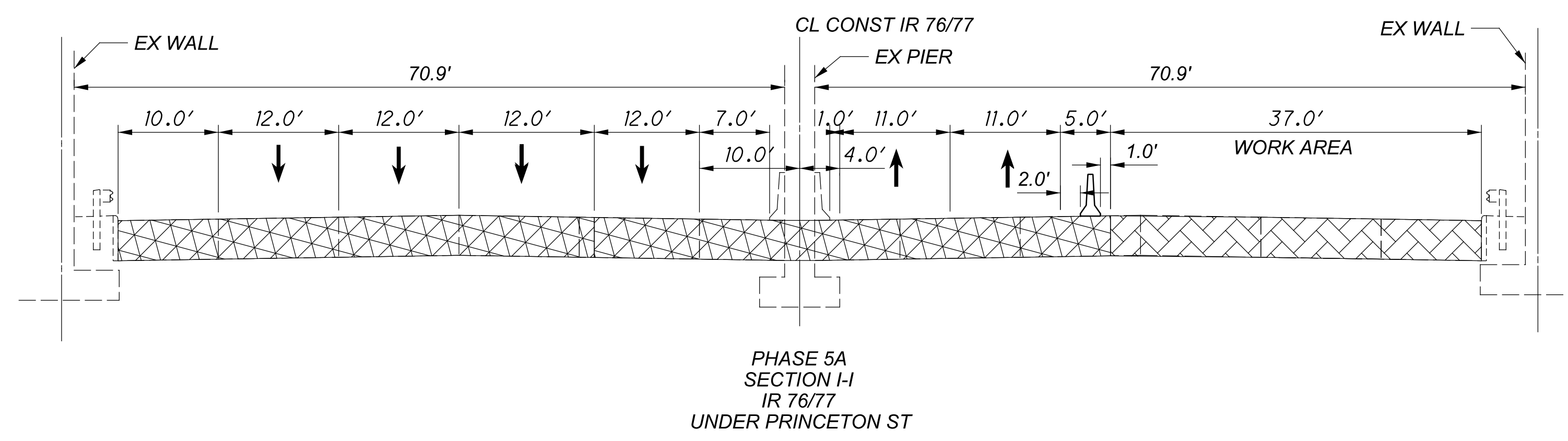

2021-09-29 - BU 05 - RELEASED FOR CONSTRUCTION PLANS

MOT IR 76 / IR 77 PHASE 5A - STEP 1
 STA 311+50 TO STA 324+00

SUM-76 / 77 / 8-
 8.24 / 9.74 / 0.00

d:\va\vaipwintol\parsons.com\Ohio State\Documents\DB-Akron Beltway Rehab\10 - Design\02329\M0T\Sheets\BU-05\02329_MPB05516.dgn Sheet 9/28/2021 09:41 PM aplipchuk

- NOTES:
1. FOR LEGEND SEE SHEET 19
 2. ALL STATIONING TAKEN FROM C CONSTRUCTION IR 76/IR 77 UNLESS OTHERWISE NOTED
 3. FOR DRUM SPACING SEE MT-95.40, TABLE II
 4. FOR PB FLARE RATE SEE MT-95.40, TABLE II

Released for Construction
 Thomas J Powell, PE
 10/04/2021

ISSUE RECORD:		
NO.	DATE	DESCRIPTION

CALCULATED
 VJ
 CHECKED
 AVP

0 50 100
 HORIZONTAL
 SCALE IN FEET

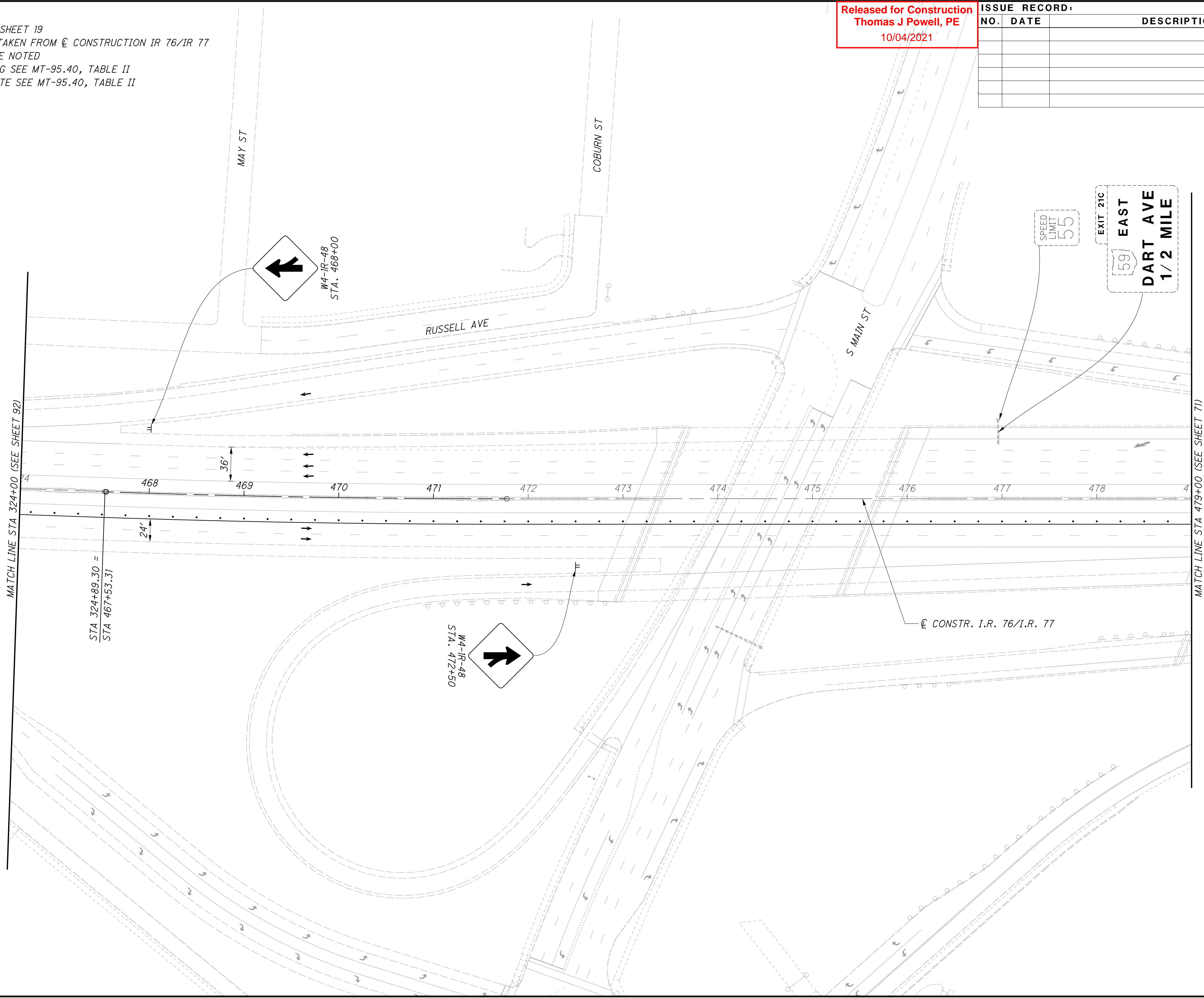

2021-09-29 - BU 05 - RELEASED FOR CONSTRUCTION PLANS

MOT IR 76 / IR 77 PHASE 5A - STEP 1
 STA 324+00 TO STA 479+00

SUM-76 / 77 / 8-
 8.24 / 9.74 / 0.00

93
 105

dw:\VANVAOPWINTO\parsons.com:Ohio State\Documents\Beltway Rehab\10 - Design\02329\MOT\Sheets\BU-05\02329_MPBW5719.dgn_Sheet 9/28/2021 10:09:49 PM aplipchuk

Released for Construction
 Thomas J Powell, PE
 10/04/2021

ISSUE RECORD:		
NO.	DATE	DESCRIPTION

- NOTES:
- FOR LEGEND, SEE SHEET 19
 - ALL STATIONING TAKEN FROM \varnothing CONSTRUCTION IR 76 / IR 77 UNLESS OTHERWISE NOTED
 - FOR DRUM SPACING SEE MT-95.40, TABLE II
 - FOR PB FLARE RATE SEE MT-95.40, TABLE II

CALCULATED
 VJ
 CHECKED
 AVP

0 50 100
 HORIZONTAL
 SCALE IN FEET

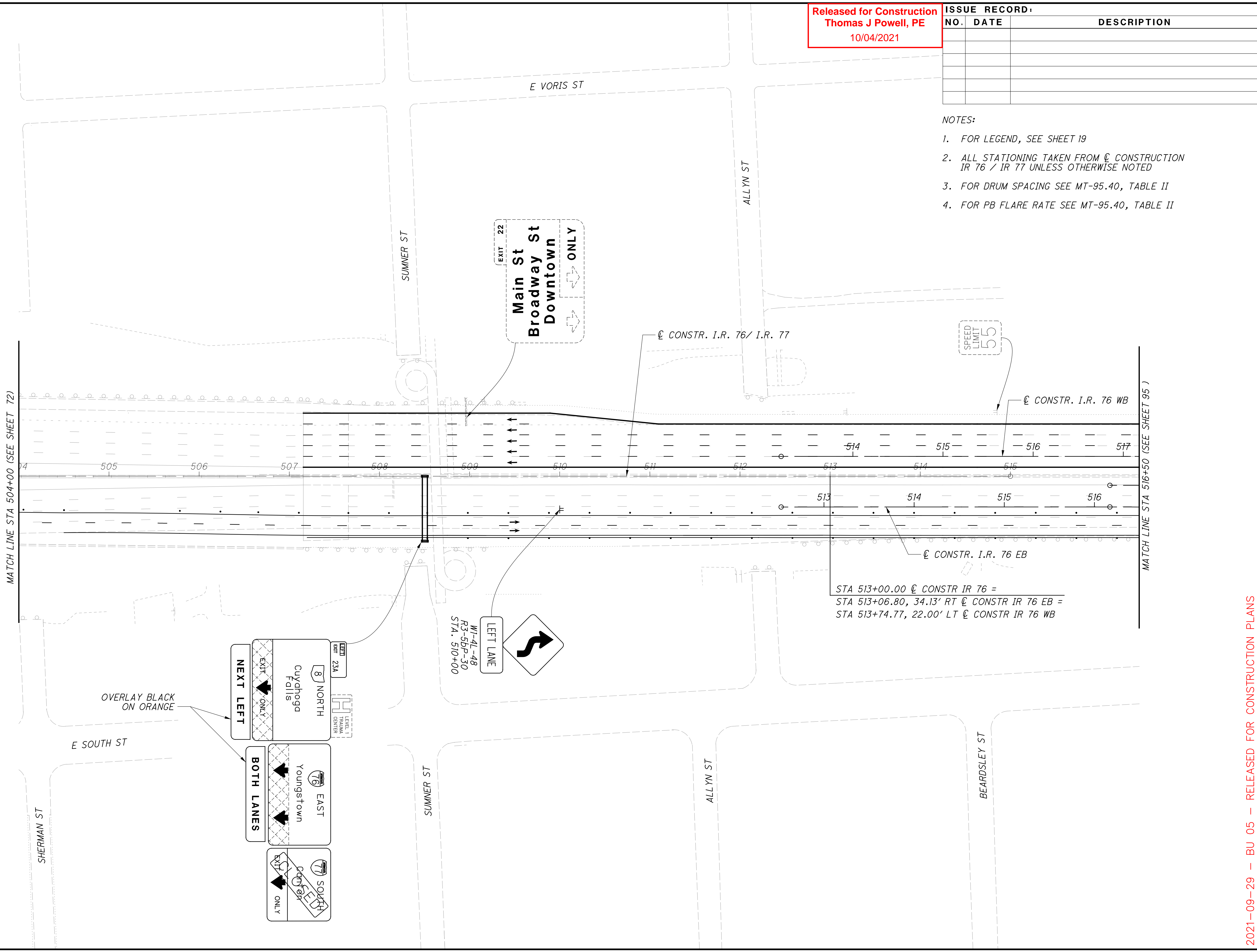

STA 513+00.00 \varnothing CONSTR IR 76 =
 STA 513+06.80, 34.13' RT \varnothing CONSTR IR 76 EB =
 STA 513+74.77, 22.00' LT \varnothing CONSTR IR 76 WB

2021-09-29 - BU 05 - RELEASED FOR CONSTRUCTION PLANS

MOT IR 76 / IR 77 PHASE 5A - STEP 2
 STA 504+00 TO STA 516+50

SUM-76 / 77 / 8-
 8.24 / 9.74 / 0.00

pw:\VANVAOPWINTO\parsons.com:Ohio State\Documents\DB-Akron Beltway Rehab\0 - Design\02329\M0T\Sheets\BU-05\02329_MPB051720.dgn Sheet 9/28/2021 10:09:57 PM aplipchuk

Released for Construction
 Thomas J Powell, PE
 10/04/2021

ISSUE RECORD:		
NO.	DATE	DESCRIPTION

NOTES:
 1. FOR LEGEND SEE SHEET 19
 2. ALL STATIONING TAKEN FROM \varnothing CONSTRUCTION IR 76 EB UNLESS OTHERWISE NOTED
 3. FOR DRUM SPACING SEE MT-95.40, TABLE II
 4. FOR PB FLARE RATE SEE MT-95.40, TABLE II

CALCULATED VJ
 CHECKED AVP

HORIZONTAL SCALE IN FEET

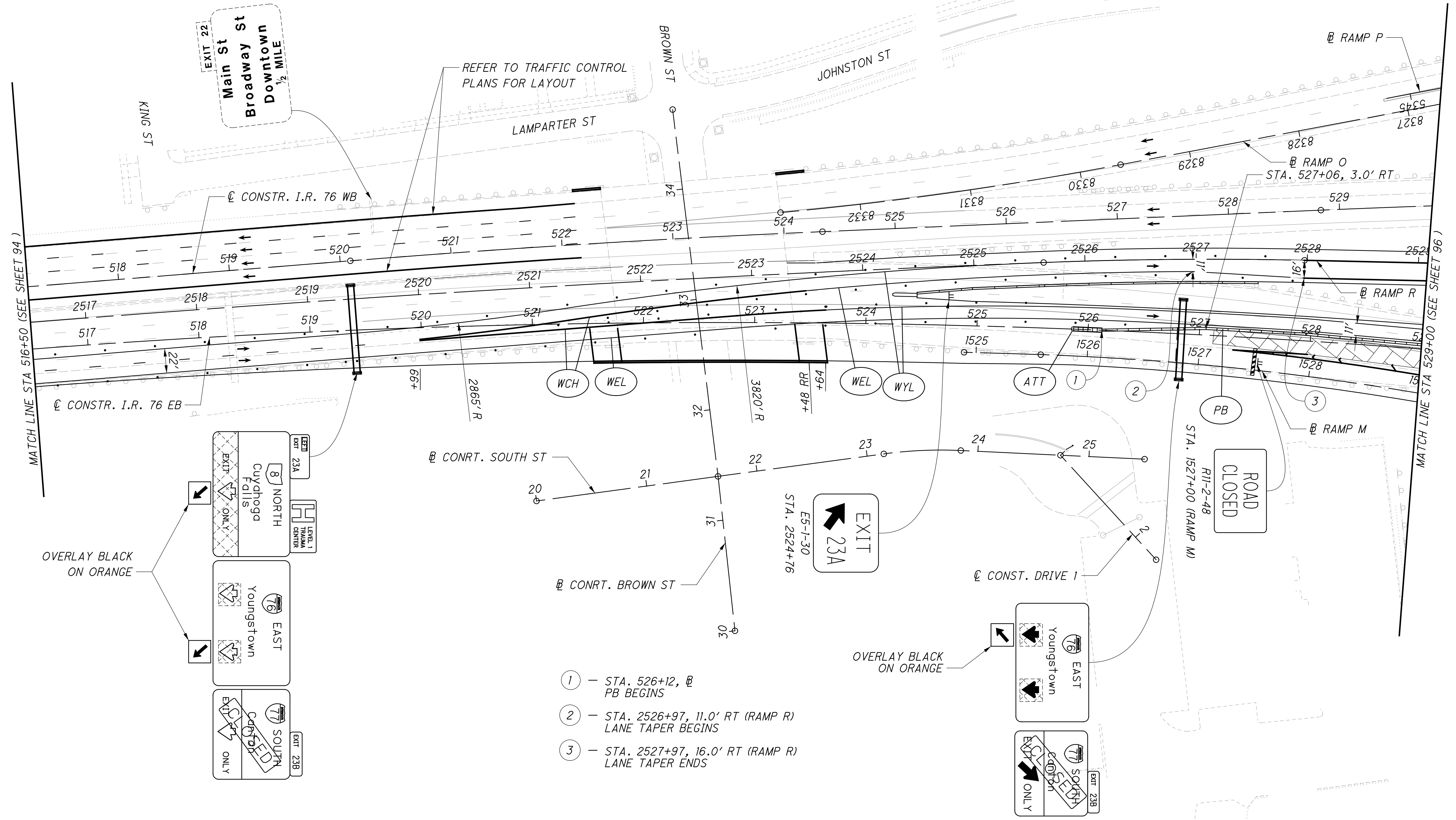

OVERLAY BLACK ON ORANGE

EXIT 238

SOUTH ONLY

EXIT 238

EXIT 238A

NORTH ONLY

EXIT 238A

EXIT 238B

EAST ONLY

EXIT 238B

EXIT 238C

SOUTH ONLY

EXIT 238C

- ① - STA. 526+12, \varnothing PB BEGINS
- ② - STA. 2526+97, 11.0' RT (RAMP R) LANE TAPER BEGINS
- ③ - STA. 2527+97, 16.0' RT (RAMP R) LANE TAPER ENDS

2021-09-29 - BU 05 - RELEASED FOR CONSTRUCTION PLANS

MOT IR 76 / IR 77 PHASE 5A - STEP 2
 STA 516+50 TO STA 529+00

SUM-76 / 77 8 -
 8.24 / 9.74 / 0.00

d:\VANVAOPWINTO\parsons.com\Ohio State\Documents\DB-Akron Beltway Rehab\10 - Design\02329\M0T\Sheets\BU-05\02329.MPB\BU5721.dgn Sheet 9/28/2021 10:10:10 AM aplilpchuk

Released for Construction
Thomas J Powell, PE
10/04/2021

ISSUE RECORD:		
NO.	DATE	DESCRIPTION

- NOTES:
- FOR LEGEND SEE SHEET 19
 - ALL STATIONING TAKEN FROM \odot CONSTRUCTION IR 76 / IR 77 UNLESS OTHERWISE NOTED
 - FOR DRUM SPACING SEE MT-95.40, TABLE II
 - FOR PB FLARE RATE SEE MT-95.40, TABLE II

CALCULATED VJ CHECKED AVP

0 50 100
25
HORIZONTAL SCALE IN FEET

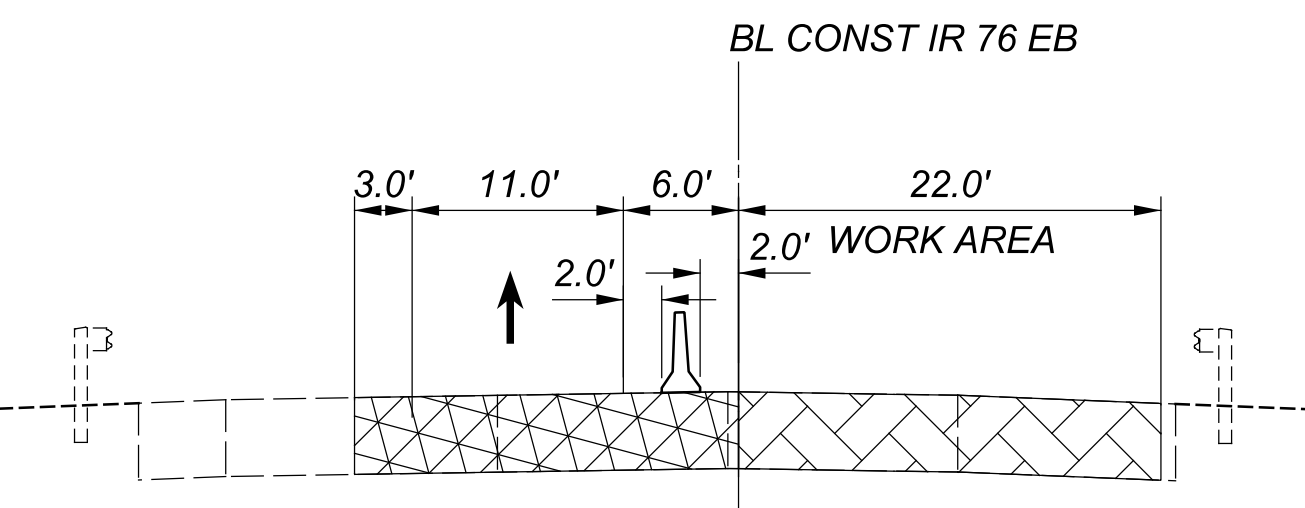
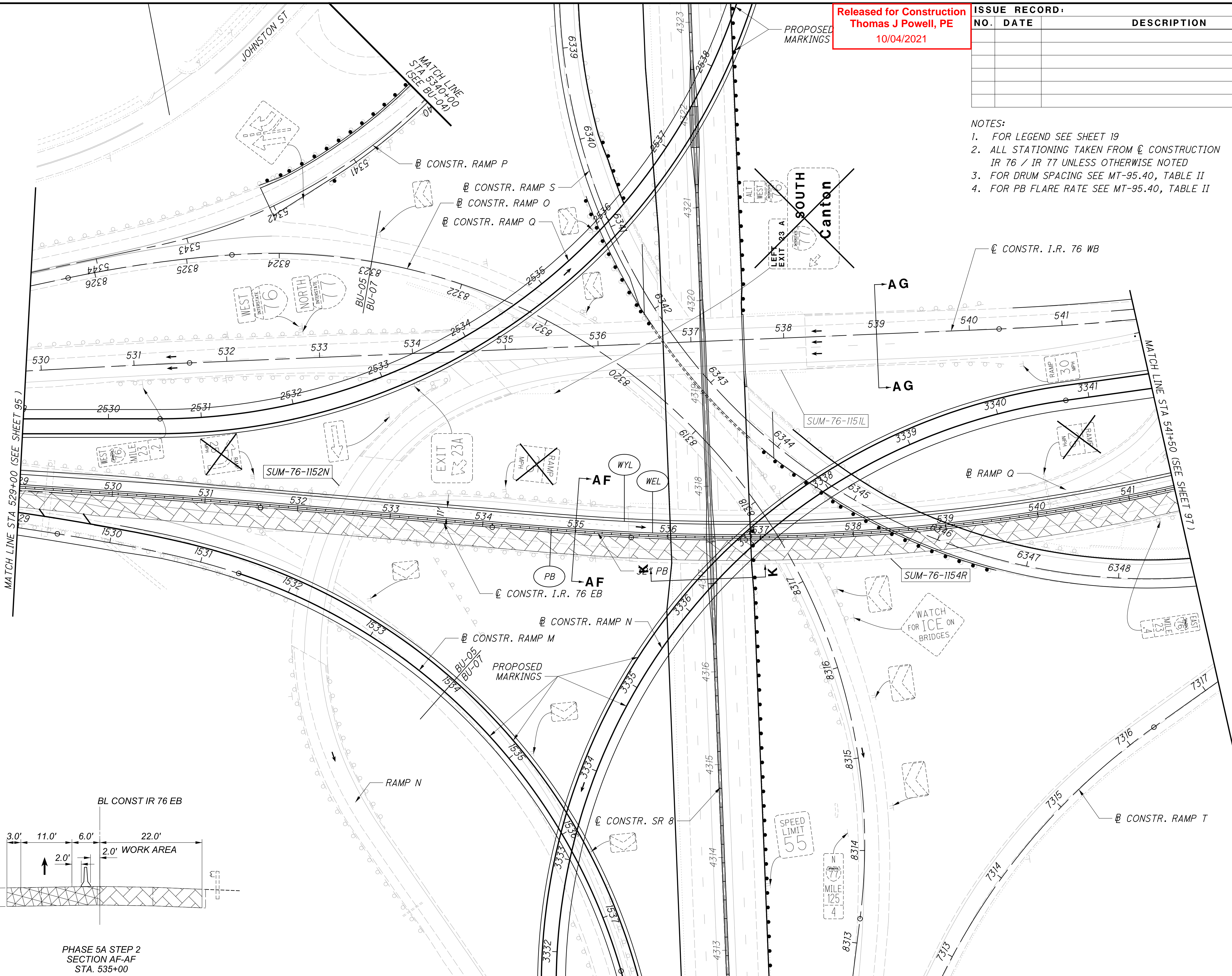

PHASE 5A STEP 2
SECTION AF-AF
STA. 535+00

2021-09-29 - BU 05 - RELEASED FOR CONSTRUCTION PLANS

MOT IR 76 / IR 77 PHASE 5A - STEP 2
STA 529+00 TO STA 541+50

SUM-76 / 77 / 8 -
8.24 / 9.74 / 0.00

96
105

d:\va\p\w\int\parsons.com\Ohio State\Documents\DB-Akron Beltway Rehab\0 - Design\02329\M0T\Sheets\BU-05\02329.MPB\5723.dgn Sheet 9/28/2021 10:26 PM aplipchuk

Released for Construction
 Thomas J Powell, PE
 10/04/2021

ISSUE RECORD:		
NO.	DATE	DESCRIPTION

CALCULATED VJ
 CHECKED AVP

0 50 100
 HORIZONTAL SCALE IN FEET

- NOTES:
- FOR LEGEND SEE SHEET 19
 - ALL STATIONING TAKEN FROM @ CONSTRUCTION IR 76 EB UNLESS OTHERWISE NOTED
 - FOR DRUM SPACING SEE MT-95.40, TABLE II
 - FOR PB FLARE RATE SEE MT-95.40, TABLE II

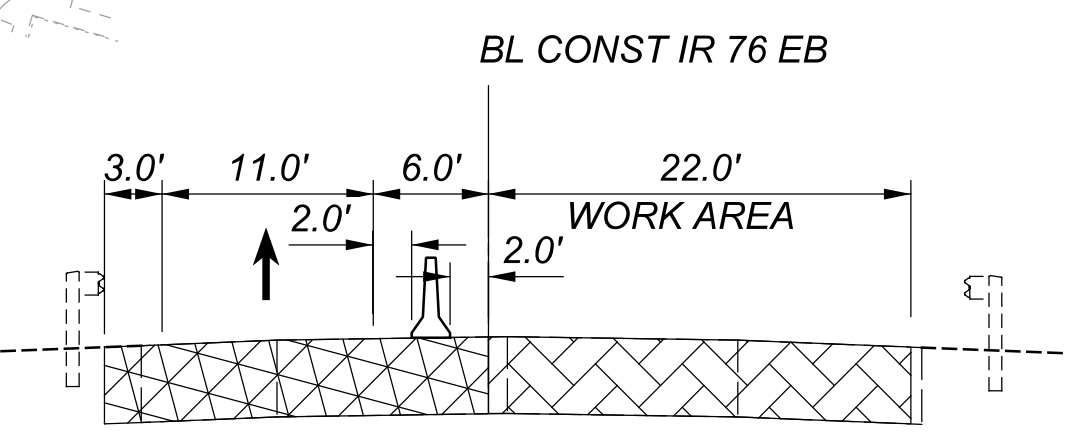
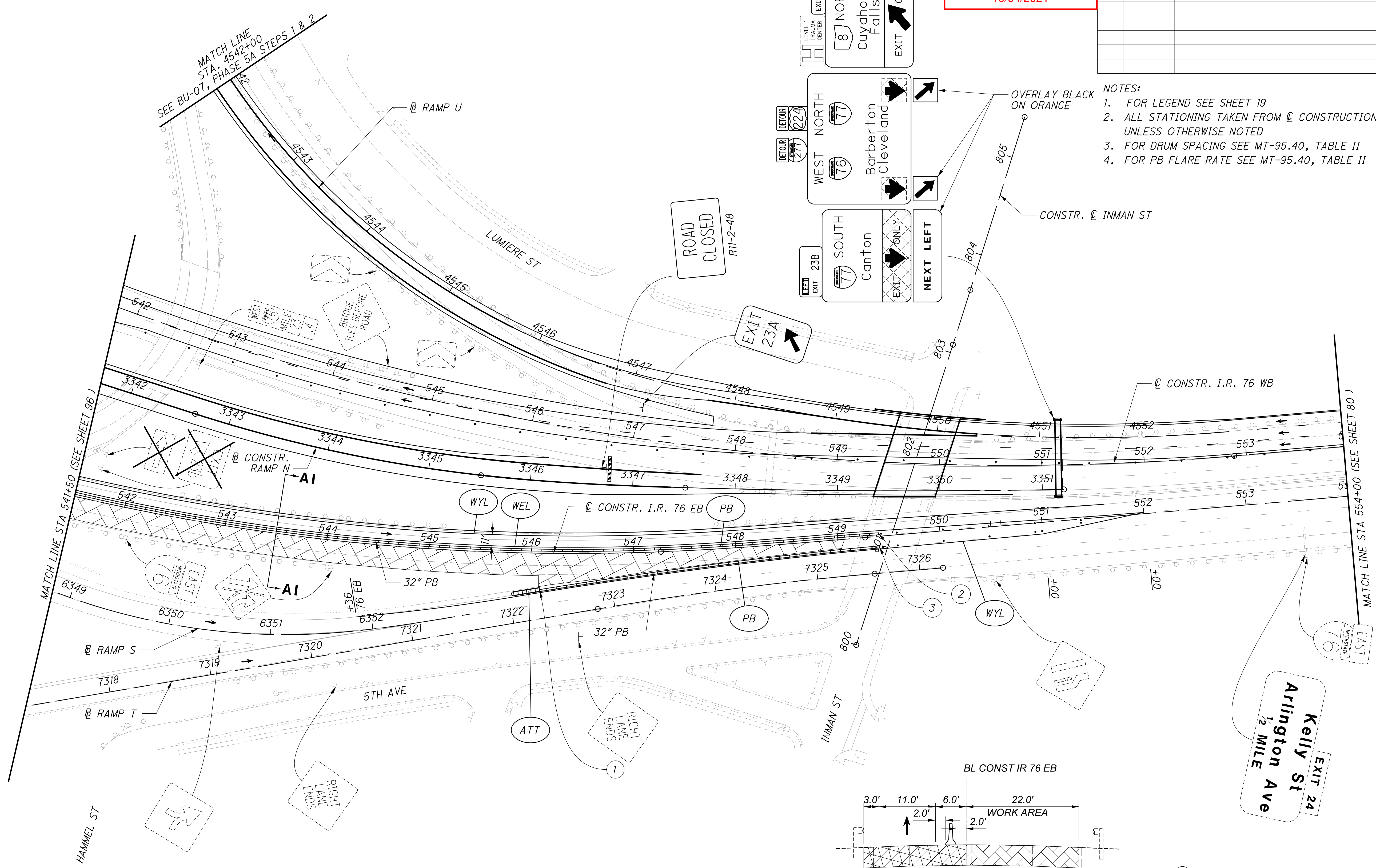

PHASE 5A STEP 2
 SECTION AI-AI
 STA. 543+50

- STA. 546+09, 35.5' RT PB BEGINS
- STA. 549+40, 3.0' LT PB ENDS
- STA. 549+40, 10.5' RT PB ENDS

2021-09-29 - BU 05 - RELEASED FOR CONSTRUCTION PLANS

MOT IR 76 / IR 77 PHASE 5A - STEP 2
 STA 541+50 TO STA 554+00
 SUM-76/77/8-8.24/9.74/0.00

p:\VANVAOPWINTO\parsons.com\Ohio State\Documents\DB-Akron Beltway Rehab\0 - Design\02329\M0T\Sheets\BU-05\02329.MPB\05819.dgn_Sheet 9/28/2021 10:33 PM apilipchuk

ADVANCED WARNING SIGNS - IR 76/77

TYPE A WARNING LIGHT

RIGHT LANE CLOSED AHEAD
W20-5-48
STA. 486+50

CONSTRUCTION SIGN
W4-2R-48
STA. 501+50

Released for Construction
 Thomas J Powell, PE
 10/04/2021

ISSUE RECORD:

NO.	DATE	DESCRIPTION

- NOTES:**
- FOR LEGEND, SEE SHEET 19
 - ALL STATIONING TAKEN FROM C I.R. 76 / I.R. 77 UNLESS OTHERWISE NOTED
 - FOR DRUM SPACING SEE MT-95.40, TABLE II
 - FOR PB FLARE RATE SEE MT-95.40, TABLE II

CALCULATED VJ
 CHECKED AVP
 HORIZONTAL SCALE IN FEET
 0 25 50 100

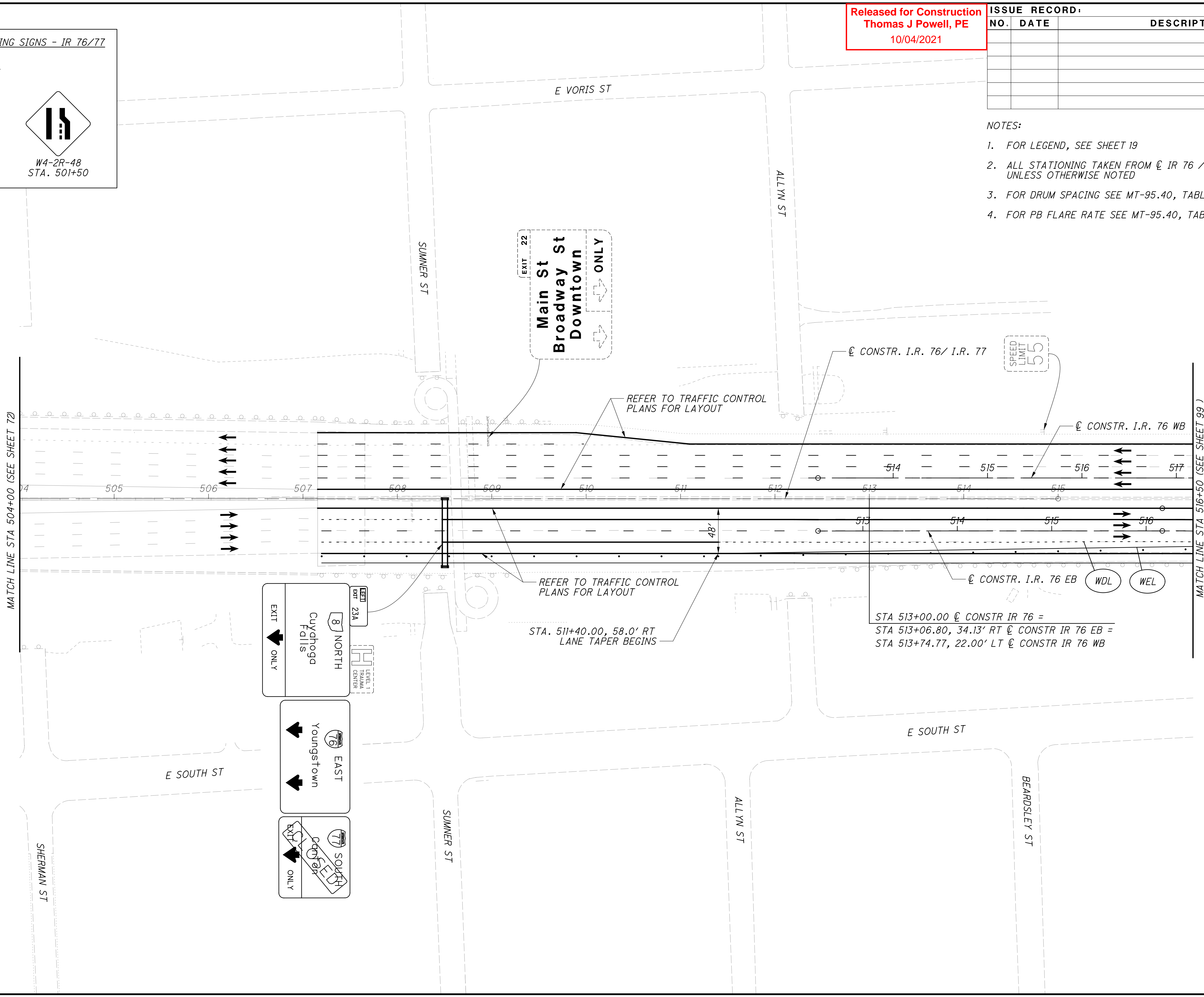

2021-09-29 - BU 05 - RELEASED FOR CONSTRUCTION PLANS

MOT IR 76 / IR 77 PHASE 5B
STA 504+00 TO STA 516+50

SUM-76 / 77 / 8-
8.24 / 9.74 / 0.00

98
 105

pw:\VANVAOPWINTO\parsons.com:Ohio State\Documents\DB-Akron Beltway Rehab\0 - Design\02329\M0T\Sheets\BU-05\02329_MPB05820.dgn Sheet 9/28/2021 10:42 PM aplipchuk

Released for Construction
 Thomas J Powell, PE
 10/04/2021

ISSUE RECORD:		
NO.	DATE	DESCRIPTION

- NOTES:
- FOR LEGEND SEE SHEET 19
 - ALL STATIONING TAKEN FROM @ CONSTRUCTION IR 76 WB UNLESS OTHERWISE NOTED
 - FOR DRUM SPACING SEE MT-95.40, TABLE II
 - FOR PB FLARE RATE SEE MT-95.40, TABLE II

100

25

HORIZONTAL SCALE IN FEET

CALCULATED

VJ

CHECKED

AVP

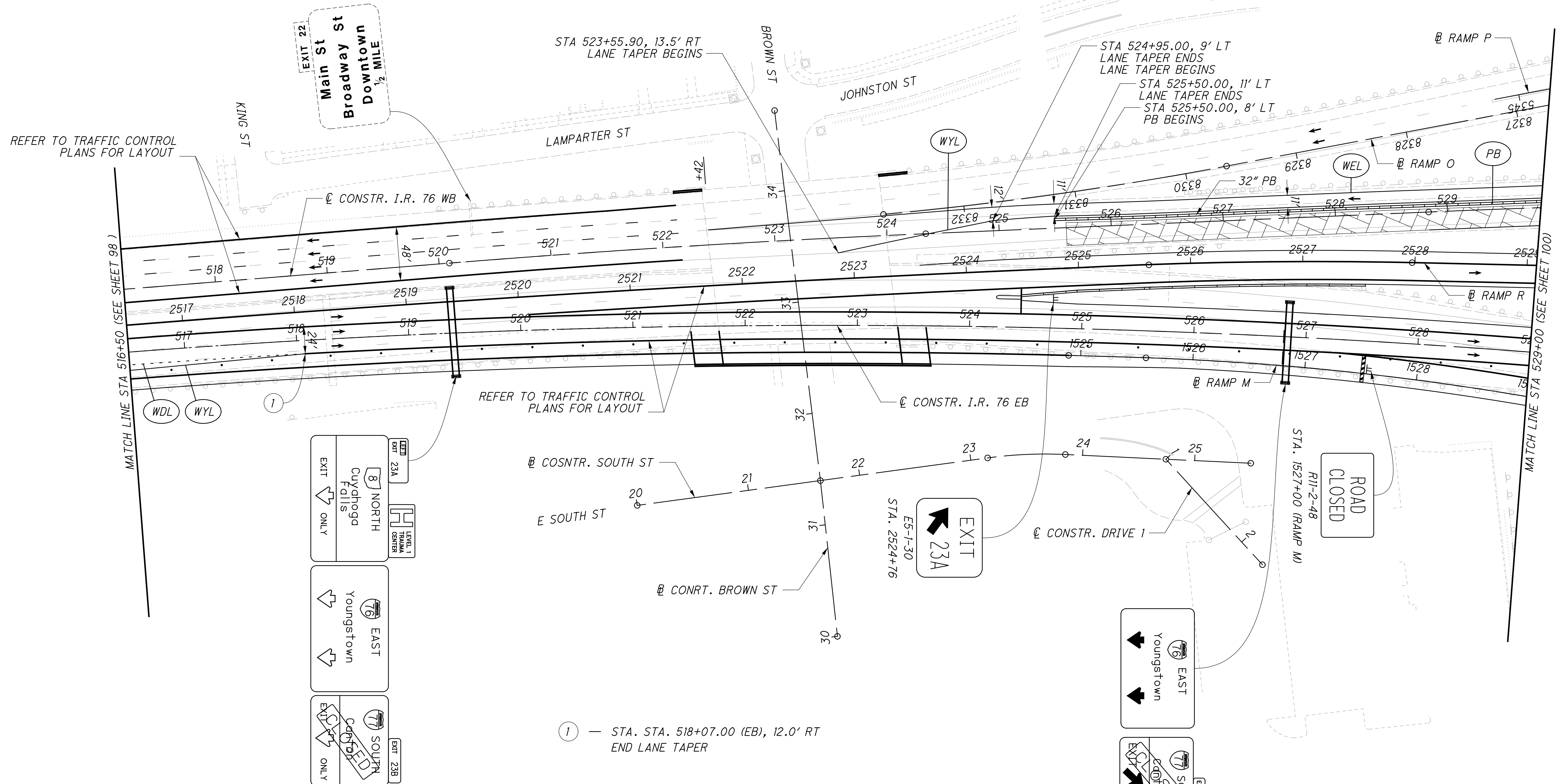

MATCH LINE STA 516+50 (SEE SHEET 98)

MATCH LINE STA 529+00 (SEE SHEET 100)

EXIT 22
 Main St
 Broadway St
 Downtown
 1/2 MILE

EXIT 238

←

SOUTH
Cody
EXIT ONLY

EXIT 239

←

EAST
Youngstown
EXIT ONLY

EXIT 23A

←

NORTH
Cuyahoga Falls
EXIT ONLY

EXIT 1

←

TRAUMA CENTER

① — STA. STA. 518+07.00 (EB), 12.0' RT END LANE TAPER

2021-09-29 - BU 05 - RELEASED FOR CONSTRUCTION PLANS

SUM-76 / 77 / 8 -
 8.24 / 9.74 / 0.00

MOT IR 76 / IR 77 PHASE 5B
 STA 516+50 TO STA 529+00

99

105

d:\VANVAIPWINTO\parsons.com\Ohio State\Documents\DB-Akron Beltway Rehab\10 - Design\02329\M0T\Sheets\BU-05\02329.MPB\BU5821.dgn Sheet 9/28/2021 10:50 PM aplipchuk

Released for Construction
Thomas J Powell, PE
10/04/2021

ISSUE RECORD:		
NO.	DATE	DESCRIPTION

- NOTES:
- FOR LEGEND SEE SHEET 19
 - ALL STATIONING TAKEN FROM \varnothing CONSTRUCTION IR 76 WB UNLESS OTHERWISE NOTED
 - FOR DRUM SPACING SEE MT-95.40, TABLE II
 - FOR PB FLARE RATE SEE MT-95.40, TABLE II

CALCULATED VJ
CHECKED AVP

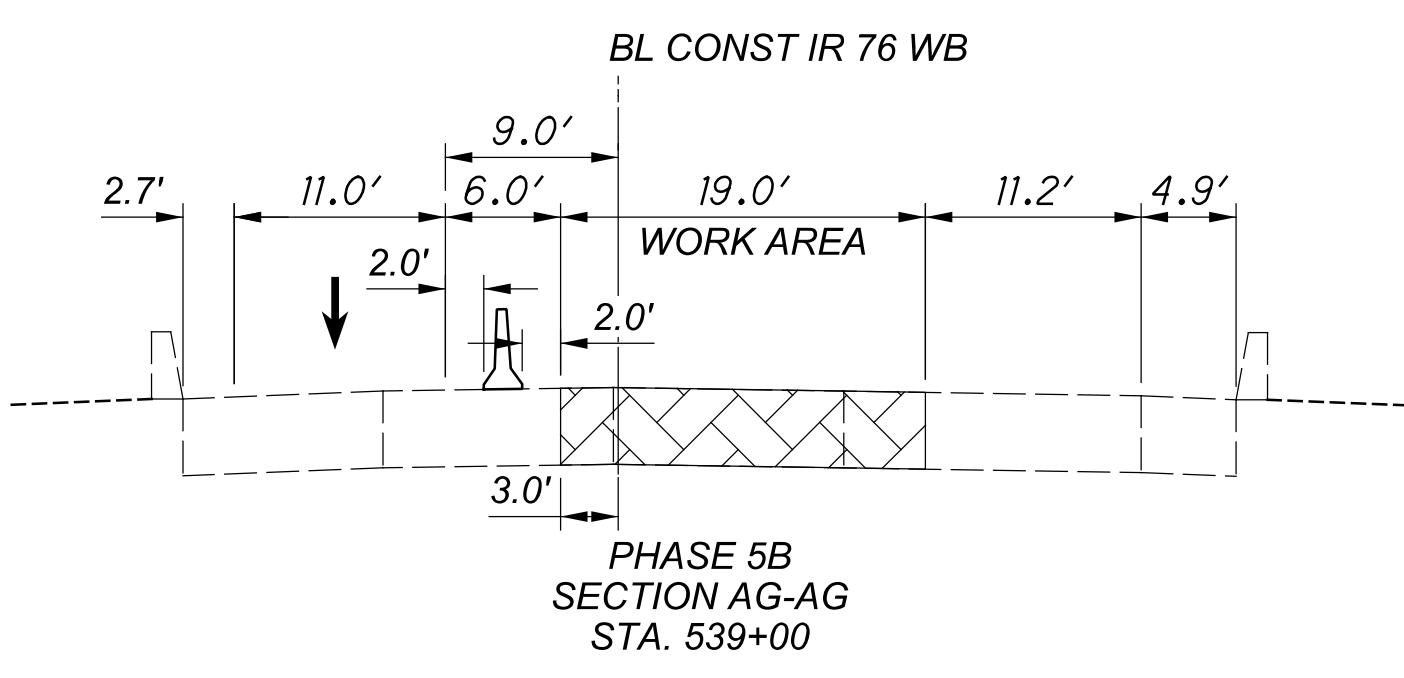
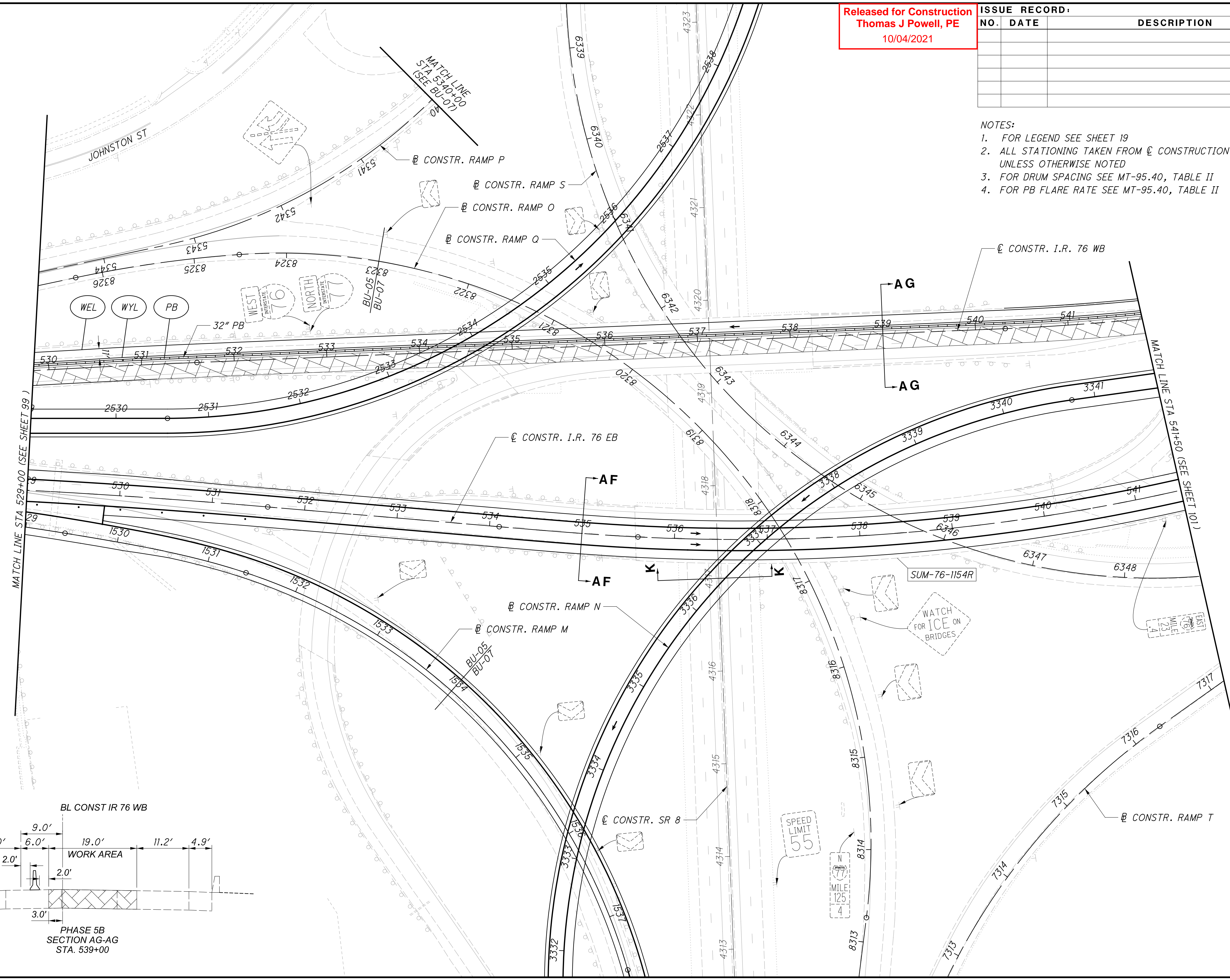

2021-09-29 - BU 05 - RELEASED FOR CONSTRUCTION PLANS

MOT IR 76 / IR 77 PHASE 5B
STA 529+00 TO STA 541+50

SUM-76 / 77 / 8 -
8.24 / 9.74 / 0.00

100
105

Released for Construction
 Thomas J Powell, PE
 10/04/2021

ISSUE RECORD:		
NO.	DATE	DESCRIPTION

- NOTES:
- FOR LEGEND SEE SHEET 19
 - ALL STATIONING TAKEN FROM ϕ CONSTRUCTION IR 76 WB UNLESS OTHERWISE NOTED
 - FOR DRUM SPACING SEE MT-95.40, TABLE II
 - FOR PB FLARE RATE SEE MT-95.40, TABLE II

CALCULATED VJ CHECKED AVP

0 50 100
 25 HORIZONTAL SCALE IN FEET

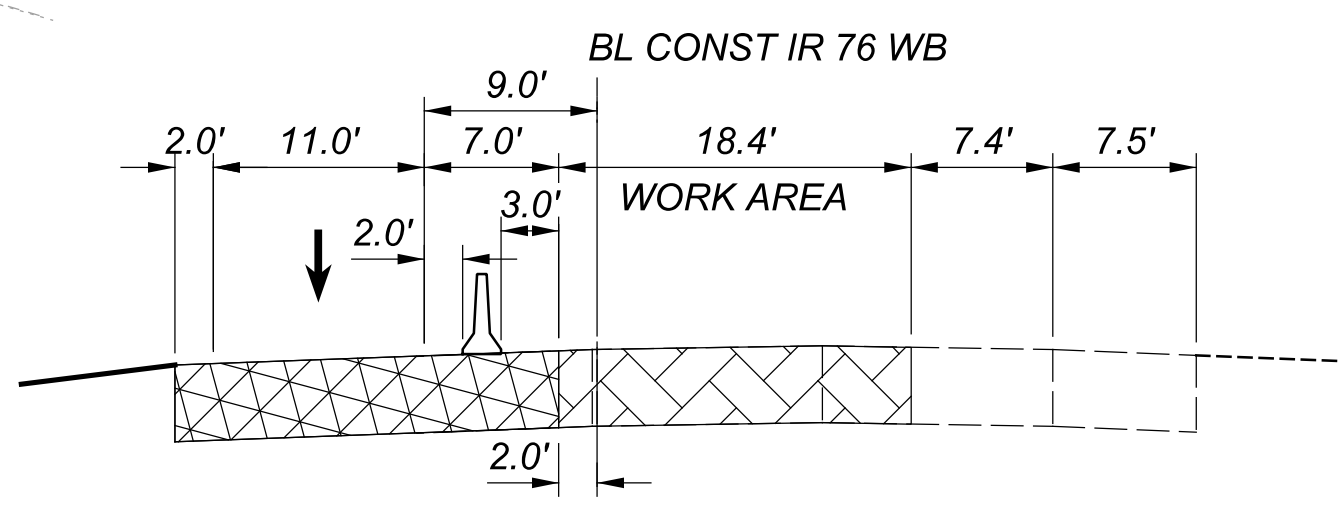
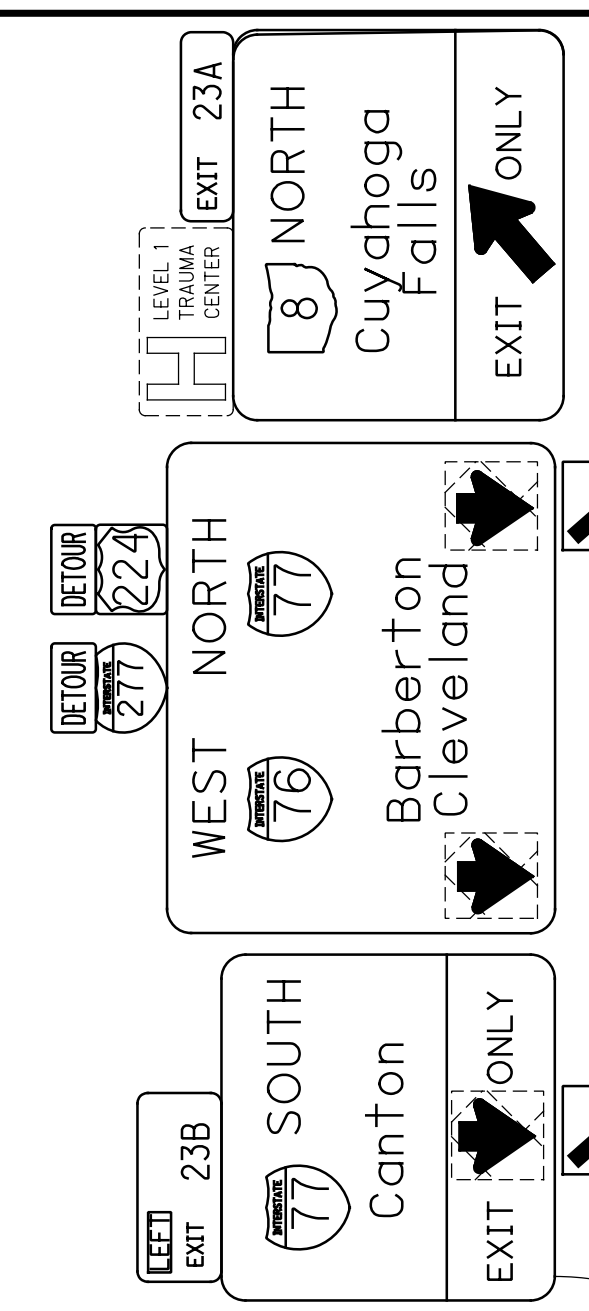
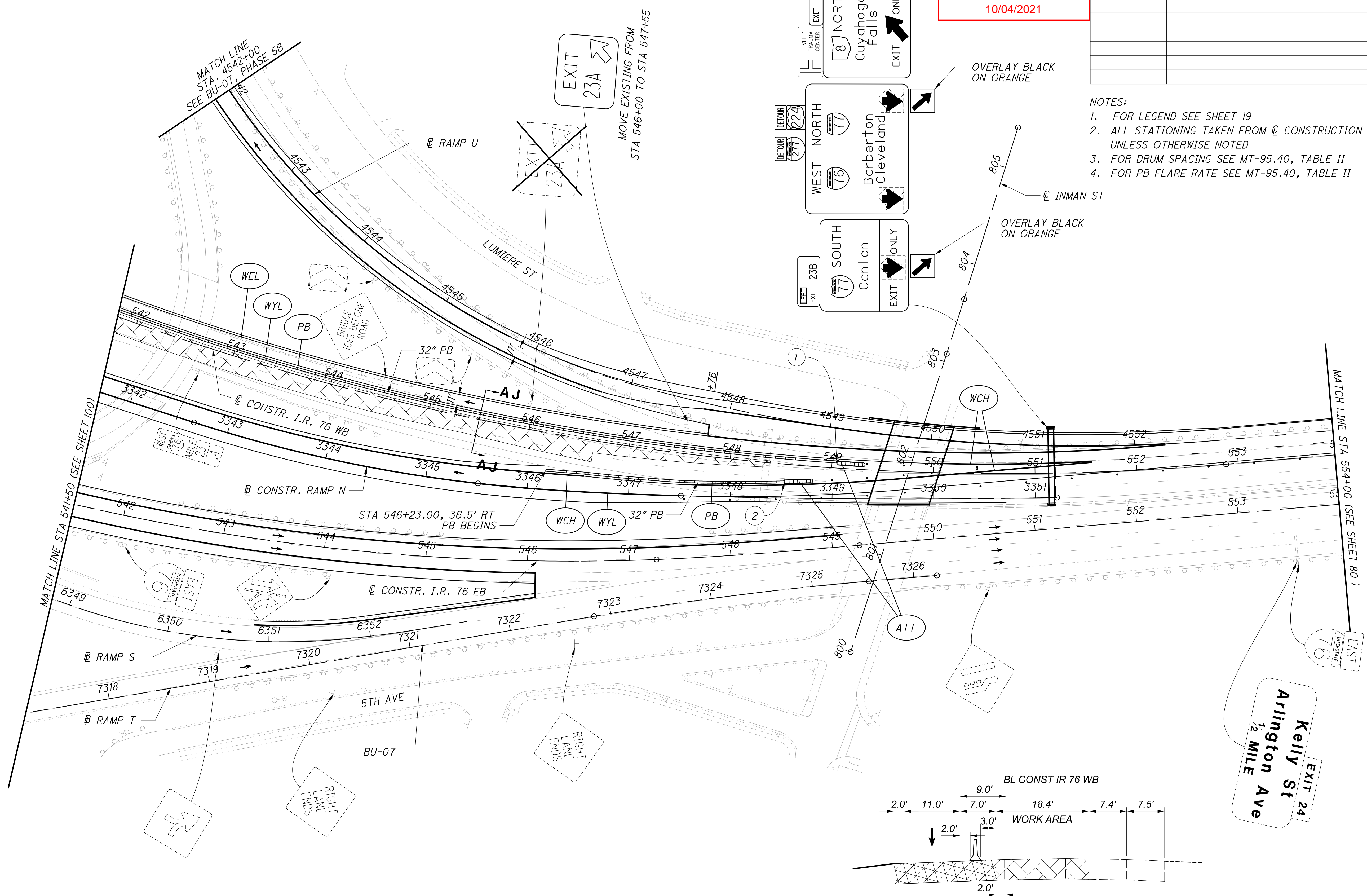

- ① — STA 549+05, 6.0' RT PB ENDS
- ② — STA 3348+53, 16.0' LT (RAMP N) PB ENDS

2021-09-29 - BU 05 - RELEASED FOR CONSTRUCTION PLANS

MOT IR 76 / IR 77 PHASE 5B
 STA 541+50 TO STA 554+00

SUM-76 / 77 / 8-
 8.24 / 9.74 / 0.00

101
 105

pw:\VANVAOPWINTO\parsons.com:Ohio State\Documents\DB-Akron Beltway Rehab\0 - Design\02329\M0T\Sheets\BU-05\02329.MPB\U5919.dgn_Sheet 9/28/2021 11:14 PM apilipchuk

Released for Construction
 Thomas J Powell, PE
 10/04/2021

ISSUE RECORD:		
NO.	DATE	DESCRIPTION

- NOTES:
- FOR LEGEND, SEE SHEET 19
 - ALL STATIONING TAKEN FROM \varnothing CONSTRUCTION IR 76 / IR 77 UNLESS OTHERWISE NOTED
 - FOR DRUM SPACING SEE MT-95.40, TABLE II
 - FOR PB FLARE RATE SEE MT-95.40, TABLE II

CALCULATED
 V J
 CHECKED
 AVP

0 50 100
 25
 HORIZONTAL
 SCALE IN FEET

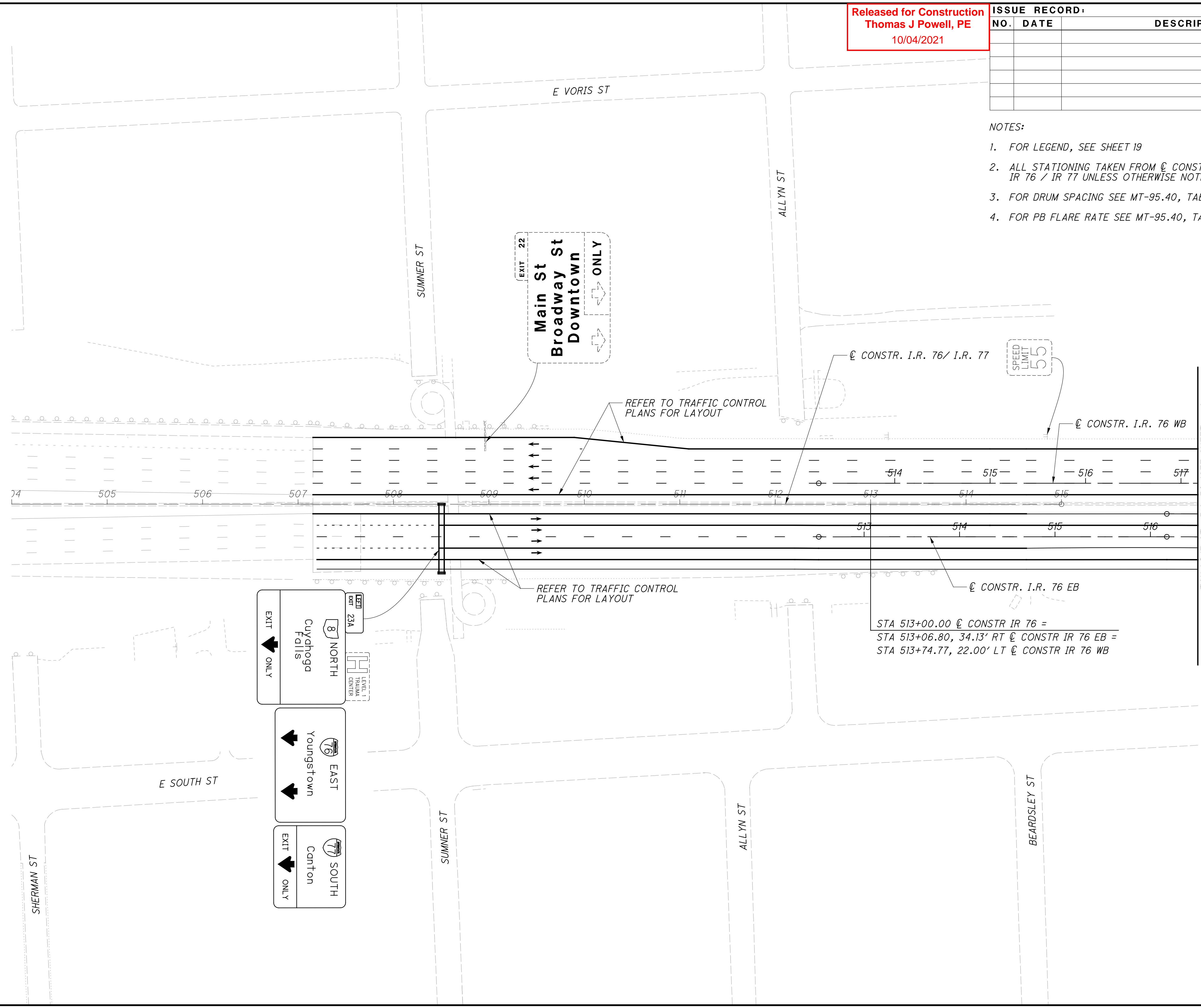

STA 513+00.00 \varnothing CONSTR IR 76 =
 STA 513+06.80, 34.13' RT \varnothing CONSTR IR 76 EB =
 STA 513+74.77, 22.00' LT \varnothing CONSTR IR 76 WB

2021-09-29 - BU 05 - RELEASED FOR CONSTRUCTION PLANS

MOT IR 76 / IR 77 PHASE 6A
 STA 504+00 TO STA 516+50

SUM-76 / 77 / 8-
 8.24 / 9.74 / 0.00

102
 105

pw:\VANVAIPWINTO\parsons.com:Ohio State\Documents\DB-Akron Beltway Rehab\0 - Design\02329\M0T\Sheets\BU-05\02329_MPBUS920.dgn Sheet 9/28/2021 11:18 PM apilipchuk

Released for Construction
Thomas J Powell, PE
10/04/2021

ISSUE RECORD:		
NO.	DATE	DESCRIPTION

NOTES:
 1. FOR LEGEND SEE SHEET 19
 2. ALL STATIONING TAKEN FROM \varnothing CONSTRUCTION IR 76 WB UNLESS OTHERWISE NOTED
 3. FOR DRUM SPACING SEE MT-95.40, TABLE II
 4. FOR PB FLARE RATE SEE MT-95.40, TABLE II

CALCULATED VJ CHECKED AVP

0 50 100
 25
 HORIZONTAL SCALE IN FEET

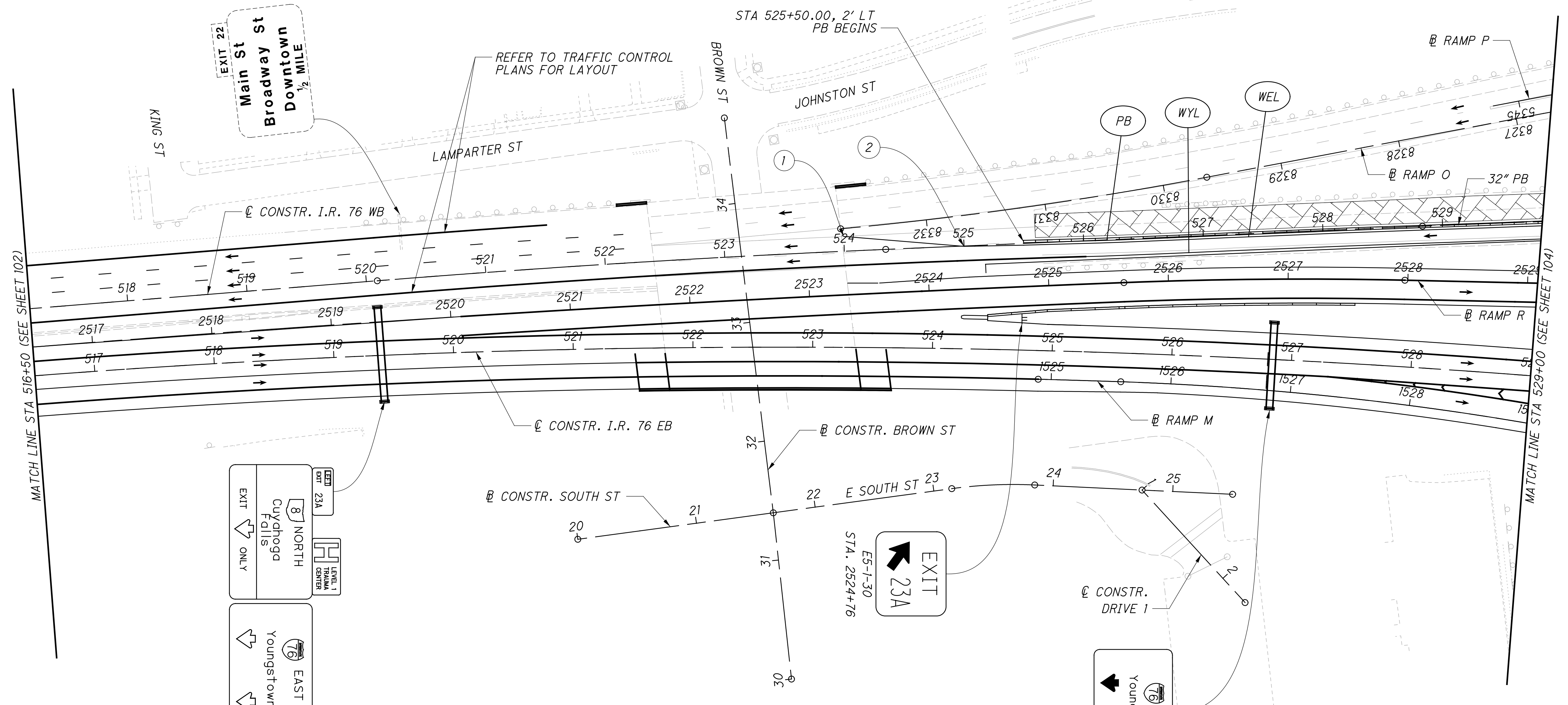

EXIT 238 SOUTH Canton

EXIT 238 EAST Youngstown

EXIT 238 NORTH Cuyahoga Falls

LEGEND 1 TRAMA CENTER

EXIT 238 SOUTH Canton

EXIT 238 EAST Youngstown

EXIT 23A

ES-1-30 STA. 2524+76

- ① — STA. 524+00, 12.0' LT LANE TAPER BEGINS
- ② — STA. 525+00, \varnothing LANE TAPER ENDS

2021-09-29 - BU 05 - RELEASED FOR CONSTRUCTION PLANS

d:\VANVAOP\WINTO\parsons.com\Ohio State\Documents\DB-Akron Beltway Rehab\10 - Design\02329\M0T\Sheets\BU-05\02329.MPB\BU5921.dgn Sheet 9/28/2021 11:24 AM apilipchuk

Released for Construction
Thomas J Powell, PE
10/04/2021

ISSUE RECORD:		
NO.	DATE	DESCRIPTION

- NOTES:
- FOR LEGEND SEE SHEET 19
 - ALL STATIONING TAKEN FROM \varnothing CONSTRUCTION IR 76 WB UNLESS OTHERWISE NOTED
 - FOR DRUM SPACING SEE MT-95.40, TABLE II
 - FOR PB FLARE RATE SEE MT-95.40, TABLE II

CALCULATED VJ CHECKED AVP

HORIZONTAL SCALE IN FEET

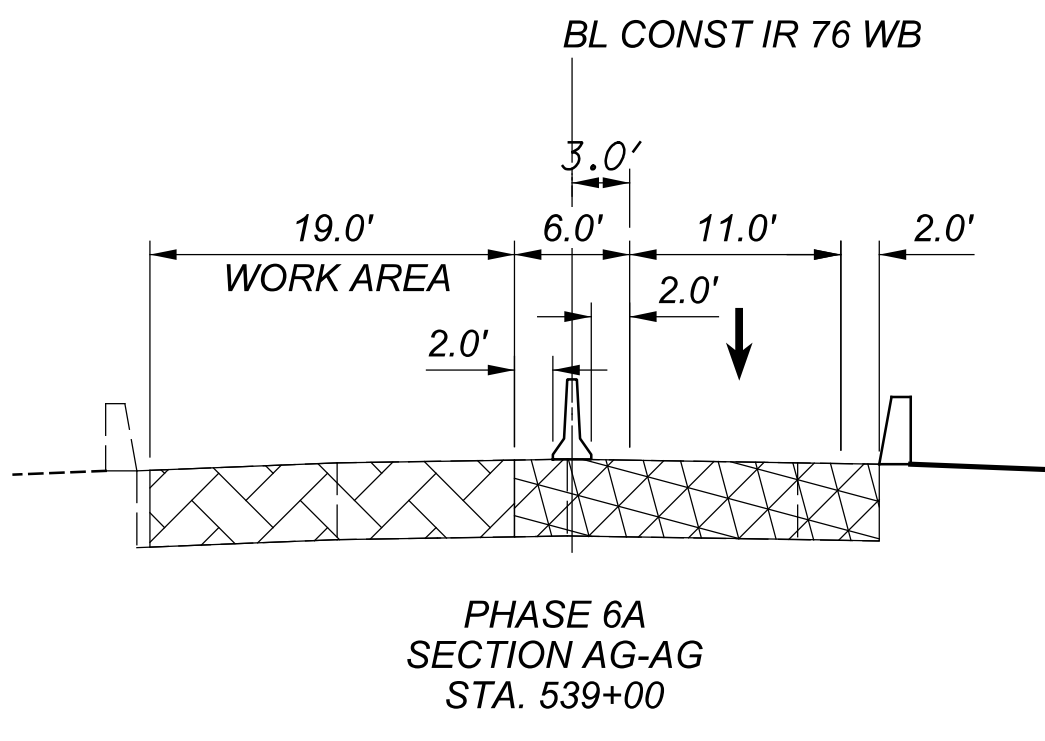
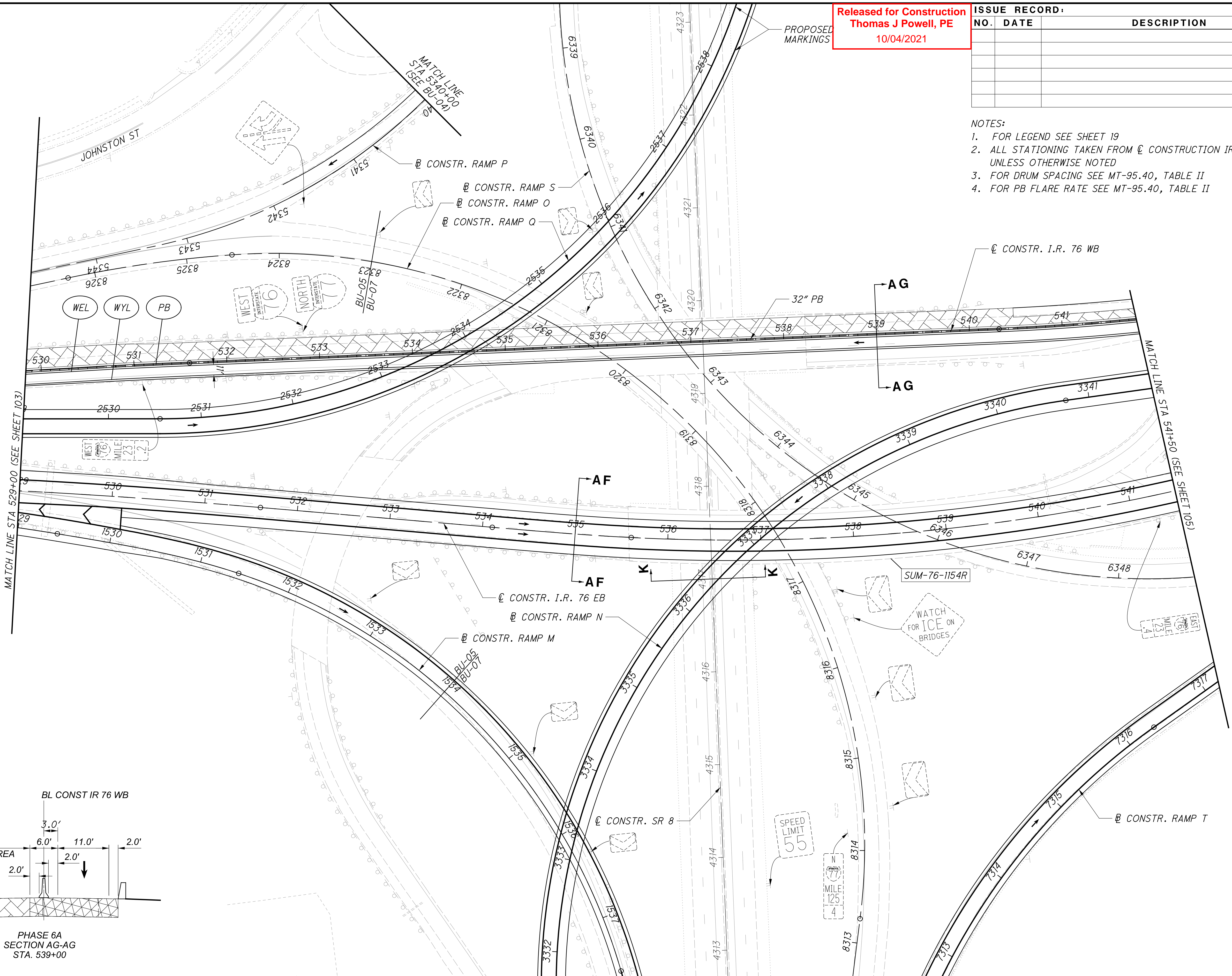

2021-09-29 - BU 05 - RELEASED FOR CONSTRUCTION PLANS

MOT IR 76 / IR 77 PHASE 6A
SUM-76 / 77 / 8 -
STA 529+00 TO 541+50
8.24 / 9.74 / 0.00

104
105

d:\va\vaipwintol\parsons.com\Ohio State\Documents\DB-Akron Beltway Rehab\0 - Design\02329\M0T\Sheets\BU-05\02329.MPB\BU5923.dgn Sheet 9/28/2021 11:28 PM aplilpchuk

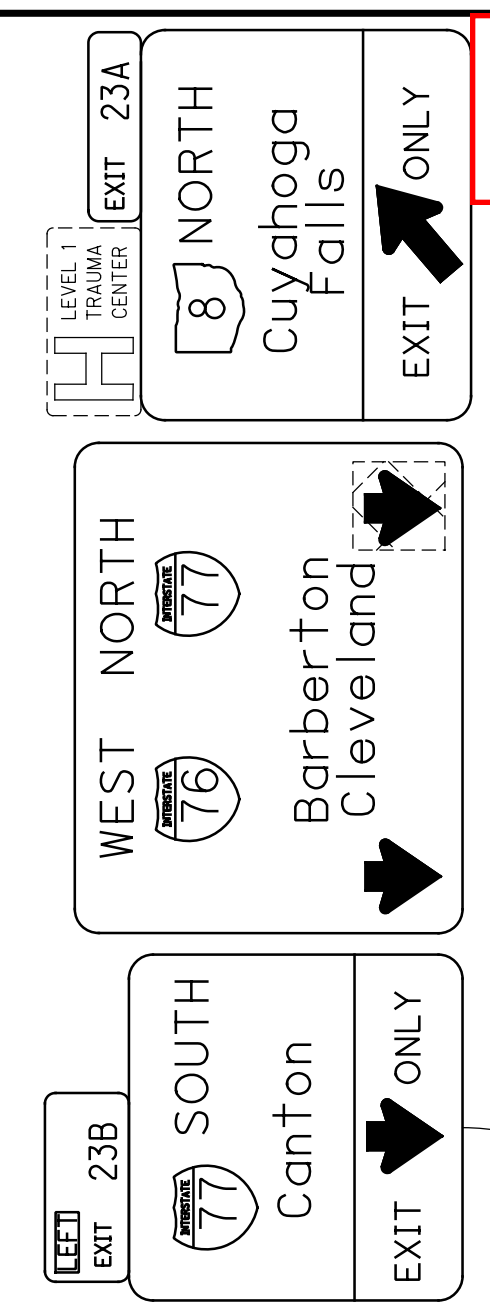
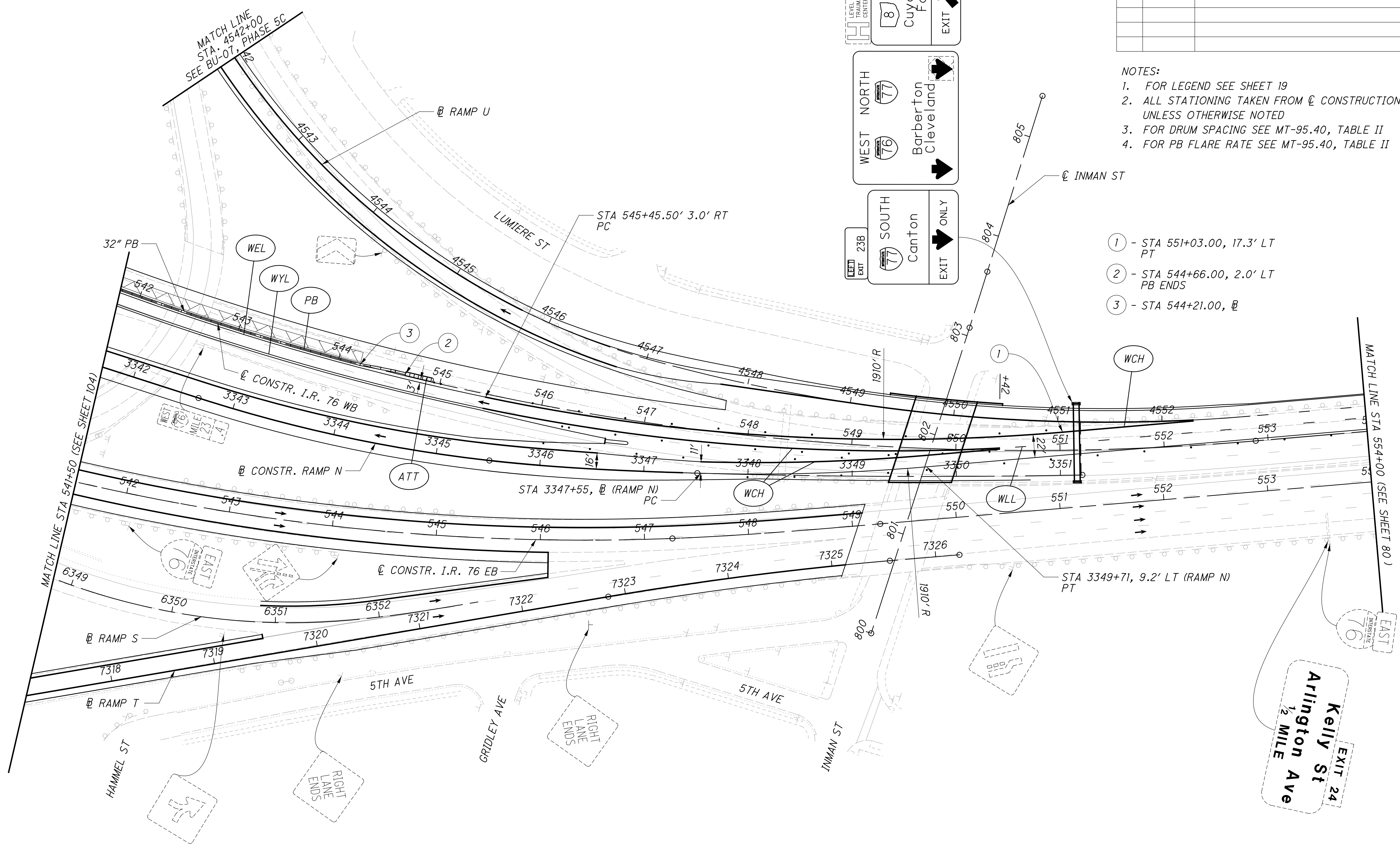

Released for Construction
 Thomas J Powell, PE
 10/04/2021

ISSUE RECORD:		
NO.	DATE	DESCRIPTION

- NOTES:
- FOR LEGEND SEE SHEET 19
 - ALL STATIONING TAKEN FROM @ CONSTRUCTION IR 76 WB UNLESS OTHERWISE NOTED
 - FOR DRUM SPACING SEE MT-95.40, TABLE II
 - FOR PB FLARE RATE SEE MT-95.40, TABLE II

- 1 - STA 551+03.00, 17.3' LT PT
- 2 - STA 544+66.00, 2.0' LT PB ENDS
- 3 - STA 544+21.00, @



2021-09-29 - BU 05 - RELEASED FOR CONSTRUCTION PLANS

SUM-76 / 77 / 8-
 8.24 / 9.74 / 0.00

MOT IR 76 / IR 77 PHASE 6A
 STA 541+50 TO STA 554+00

Kelly St
 Exit 24
 Arlington Ave
 1/2 MILE