

STATE OF OHIO DEPARTMENT OF TRANSPORTATION

WAR-S RIVER & S MAIN NS

CITY OF FRANKLIN
WARREN COUNTY

FEDERAL PROJECT NUMBER

E210267

RAILROAD INVOLVEMENT

NORFOLK SOUTHERN RAILROAD DOT #524892A and 524894N

PROJECT DESCRIPTION

INSTALL NEW TRAFFIC SIGNALS AT W 6TH ST/S RIVER ST AND W 6TH ST/S MAIN ST INTERSECTIONS FOR RAILROAD PREEMPTION AND INTERCONNECTION WITH NORFOLK SOUTHERN GRADE CROSSINGS DOT #524892A AND 524894N. INSTALL CURB RAMPs AROUND THE W 6TH ST/S RIVER ST INTERSECTION AND ON THE SOUTH SIDE OF THE W 6TH ST/S MAIN ST INTERSECTION. INSTALLATION WILL INCLUDE ADA AND MUTCD COMPLIANCE. THE PROJECT LENGTH IS 0.10 MILES.

EARTH DISTURBED AREAS

PROJECT EARTH DISTURBED AREA: 0.1 ACRES
ESTIMATED CONTRACTOR EARTH DISTURBED AREA: 0.5 ACRES
NOTICE OF INTENT EARTH DISTURBED AREA: N/A (NOI NOT REQUIRED)

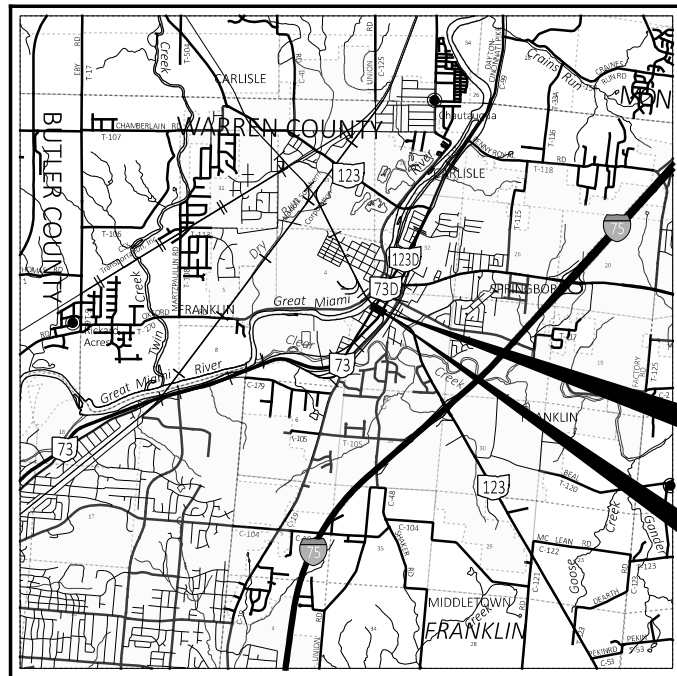

LOCATION MAP

LATITUDE: 39°33'29" LONGITUDE: -84°18'24"



| | |
|-------------------------|-------|
| PORTION TO BE IMPROVED | ===== |
| INTERSTATE HIGHWAY | ===== |
| FEDERAL ROUTES | ===== |
| STATE ROUTES | ===== |
| COUNTY & TOWNSHIP ROADS | ===== |
| OTHER ROADS | ===== |

DESIGN DESIGNATION

| | W 6TH ST. | S RIVER ST. | S MAIN ST. |
|-----------------------------------|----------------|--------------------|--------------------|
| CURRENT ADT (2025) | 1568 | 3906 | 2873 |
| DESIGN YEAR ADT (2045) | 1733 | 4316 | 3174 |
| DESIGN HOURLY VOLUME (2045) | 184 | 369 | 331 |
| DIRECTIONAL DISTRIBUTION | 93% | 100% | 100% |
| TRUCKS (24 HOUR B&C) | 1% | 1% | 1% |
| DESIGN SPEED | 35 MPH | 25 MPH | 25 MPH |
| LEGAL SPEED | 35 MPH | 25 MPH | 25 MPH |
| DESIGN FUNCTIONAL CLASSIFICATION: | MINOR ARTERIAL | PRINCIPAL ARTERIAL | PRINCIPAL ARTERIAL |
| NHS PROJECT | NO | YES | YES |

DESIGN EXCEPTIONS

NONE

ADA DESIGN WAIVERS

NONE

UNDERGROUND UTILITIES
Contact Two Working Days
Before You Dig

Before You Dig

OHIO811, 8-1-1, or 1-800-362-2764
(Non members must be called directly)

PLAN PREPARED BY:
MEAD & HUNT
4700 LAKEHURST CT, SUITE 110
COLUMBUS OH, 43016

INDEX OF SHEETS:

| | |
|------------------------|-------|
| TITLE SHEET | 1 |
| SCHEMATIC PLAN | 2 |
| GENERAL NOTES | 3-4 |
| MAINTENANCE OF TRAFFIC | 5-6 |
| GENERAL SUMMARY | 7-8 |
| SUBSUMMARIES | 9 |
| PLAN SHEETS | 10 |
| PLAN DETAILS | 11-12 |
| TRAFFIC CONTROL | 13-15 |
| TRAFFIC SIGNALS | 16-28 |

REVIEW COMPLETE

| | |
|-----------|-------|
| PM | _____ |
| BRIDGES | _____ |
| CONSTRUCT | _____ |
| DRAINAGE | _____ |
| ENVIRON | _____ |
| GEOTECH | _____ |
| ITS | _____ |
| MOT | _____ |
| PAVEMENT | _____ |
| ROADWAY | _____ |
| R/W | _____ |
| SURVEY | _____ |
| TRAFFIC | _____ |
| UTILITIES | _____ |
| OTHER | _____ |
| OTHER | _____ |

I HEREBY APPROVE THESE PLANS AND DECLARE THAT THE MAKING OF THIS IMPROVEMENT WILL NOT REQUIRE THE CLOSING TO TRAFFIC OF THE HIGHWAY AND THAT PROVISIONS FOR THE MAINTENANCE AND SAFETY OF TRAFFIC WILL BE AS SET FORTH ON THE PLANS AND ESTIMATES.

2023 SPECIFICATIONS

THE STANDARD SPECIFICATIONS OF THE STATE OF OHIO, DEPARTMENT OF TRANSPORTATION, INCLUDING SUPPLEMENTAL SPECIFICATIONS LISTED IN THE PLANS, CHANGES LISTED IN THE PROPOSAL, AND THE SUPPLEMENTAL SPECIFICATION 800 VERSION INDICATED ON THE PROPOSAL SHALL GOVERN THIS IMPROVEMENT.

Tammy K. Campbell
Tammy K. Campbell, P.E.
District 08 Deputy Director

Jack Marchbanks
Jack Marchbanks, PhD
Director, Department of Transportation

STANDARD CONSTRUCTION DRAWINGS

| STANDARD CONSTRUCTION DRAWINGS | | | | SUPPLEMENTAL SPECIFICATIONS | SPECIAL PROVISIONS |
|--------------------------------|---------|----------|---------|-----------------------------|--------------------|
| BP-3.1 | 1/21/22 | TC-74.10 | 1/20/23 | 800-2023 07/21/2023 | |
| BP-5.1 | 7/15/22 | TC-83.20 | 7/15/22 | 809 7/15/22 | |
| BP-7.1 | 1/20/23 | TC-85.20 | 4/26/23 | 816 10/18/19 | |
| | | TC-86.10 | 1/20/23 | 819 1/17/20 | |
| DM-4.3 | 1/15/16 | | | 825 1/17/20 | |
| DM-4.4 | 1/15/16 | | | 828 1/19/18 | |
| | | | | 832 7/15/22 | |
| MT-97.10 | 4/19/19 | | | 909 7/15/22 | |
| MT-97.12 | 1/20/17 | | | 916 7/15/22 | |
| | | | | 919 1/17/20 | |
| | | | | 928 1/19/18 | |
| TC-16.22 | 7/16/21 | | | | |
| TC-21.21 | 1/20/23 | | | | |
| TC-22.10 | 4/26/23 | | | | |
| TC-41.41 | 7/19/19 | | | | |
| TC-52.20 | 1/15/21 | | | | |
| TC-71.10 | 4/26/23 | | | | |

TITLE SHEET

DESIGN AGENCY
Mead & Hunt
CLIENT



DESIGNER
ARM

REVIEWER
SJS 06/07/24

PROJECT ID
115153

SHEET TOTAL
P.01 | 29

WAR-S RIVER & S MAIN NS

MODEL: Sheet_SurvF1 PAPER SIZE: 17x11 (in.) DATE: 6/7/2024 TIME: 2:07:14 PM USER: 02676 X:\4012500\220106\01115315_WAR-STW-CES ORDC 2022\115153_WAR-S River & S Main NS\400-Engineering\Roadway\Sheets\115153_GT001.dgn



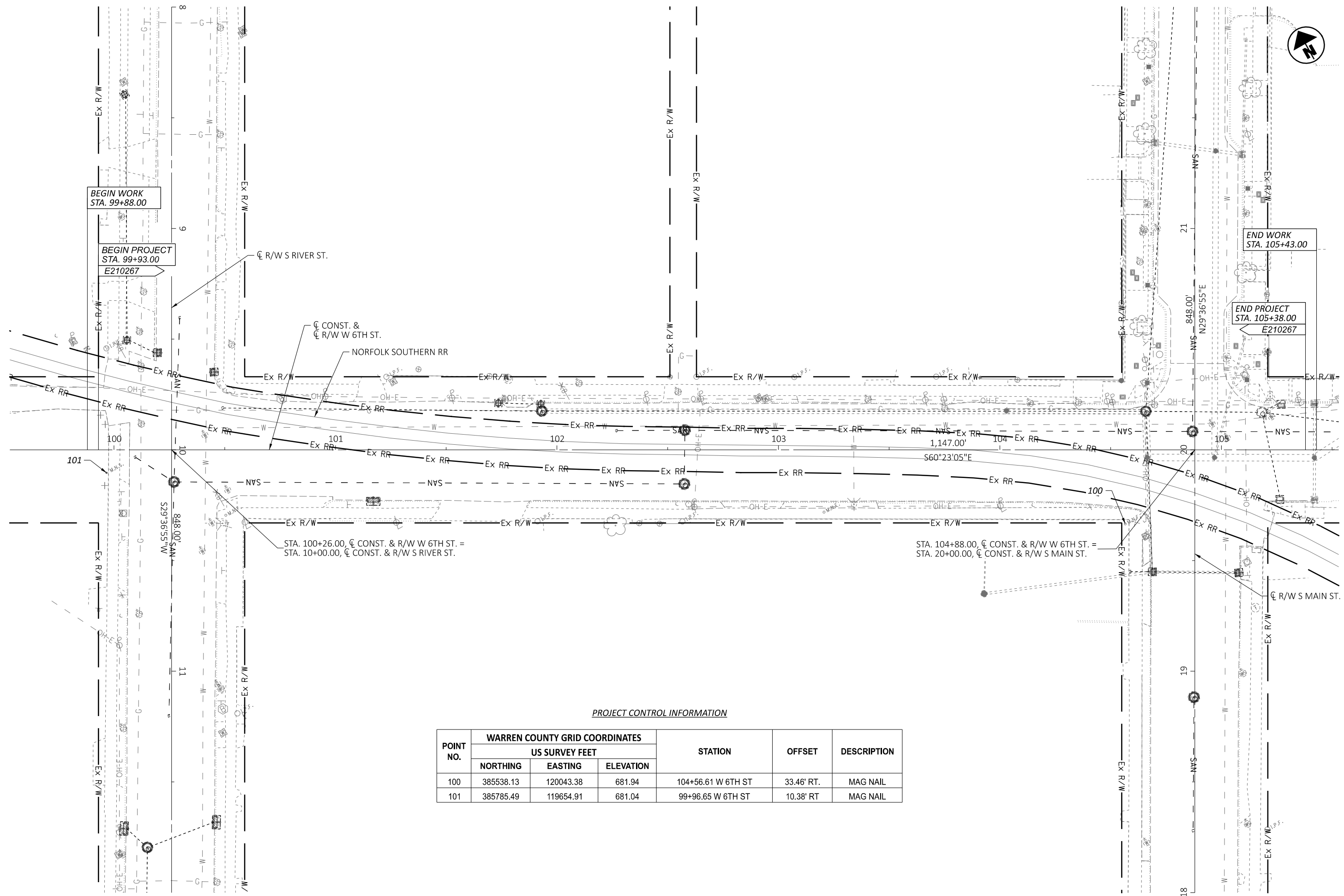

PROJECT CONTROL INFORMATION

| POINT NO. | WARREN COUNTY GRID COORDINATES | | | STATION | OFFSET | DESCRIPTION |
|-----------|--------------------------------|-----------|-----------|--------------------|------------|-------------|
| | NORTHING | EASTING | ELEVATION | | | |
| 100 | 385538.13 | 120043.38 | 681.94 | 104+56.61 W 6TH ST | 33.46' RT. | MAG NAIL |
| 101 | 385785.49 | 119654.91 | 681.04 | 99+96.65 W 6TH ST | 10.38' RT | MAG NAIL |

SCHEMATIC PLAN

DESIGN AGENCY
Mead & Hunt
 CLIENT



DESIGNER
 ARM

REVIEWER
 SJS 06/07/24

PROJECT ID
 115153

SHEET TOTAL
 P.02 29

WORK LIMITS

THE WORK LIMITS SHOWN ON THESE PLANS ARE FOR PHYSICAL CONSTRUCTION ONLY. PROVIDE THE INSTALLATION AND OPERATION OF ALL WORK ZONE TRAFFIC CONTROL AND WORK ZONE TRAFFIC CONTROL DEVICES REQUIRED BY THESE PLANS WHETHER INSIDE OR OUTSIDE THESE WORK LIMITS.

UTILITIES

LISTED BELOW ARE ALL UTILITIES LOCATED WITHIN THE PROJECT CONSTRUCTION LIMITS TOGETHER WITH THEIR RESPECTIVE OWNERS:

UTILITY CONTACTS ARE TO BE PROVIDED BY ODOT DISTRICT 8 UTILITY ENGINEER.

DUKE ENERGY ELECTRIC
2010 Dana Ave, EF324
Cincinnati, Ohio 45207
Chris Tepe
513-514-8209
chris.tepe@duke-energy.com

DUKE ENERGY GAS
139 E. Fourth St., Rm. 460A
Cincinnati, Ohio 45202
Mark Branscum or Denise Gross
OH/KYHouseBill@duke-energy.com

ALTA FIBER (FORMERLY CINCINNATI BELL)
201 E Fourth St. Bldg. 121-900
Cincinnati, Ohio 45201
513-565-7043
Robert Wittenberg
robert.wittenberg@altafiber.com

AT&T OHIO
7201 Far Hills Avenue
Dayton, Ohio 45459
Alan Stutes
937-708-1026
AS1634@att.com

WARREN COUNTY WATER & SEWER
406 Justice Drive
Lebanon, Ohio 45036
Chris Brausch
513-695-1377
Chris.brausch@co.warren.oh.us

CITY OF FRANKLIN
Nick Miller, Assistant Public Works Director
937-746-5001
nmiller@Franklinohio.org

INDEPENDENTS FIBER NETWORK/COMNET
13888 S Dixie Drive
Wapakoneta, Ohio 45895
osp@cniteam.com
Randall Plaisier
419-739-3100
plaisier@cniteam.com

THE LOCATION OF THE UNDERGROUND UTILITIES SHOWN ON THE PLANS ARE AS OBTAINED FROM THE OWNERS AS REQUIRED BY SECTION 153.64 O.R.C.

ADDITIONAL PROJECT CONTACTS

LISTED BELOW IS INFORMATION FOR ADDITIONAL PROJECT CONTACTS:

Ohio Rail Development Commission
Allen Bell - Safety Manager
614-644-0313
allen.bell@dot.ohio.gov

Ohio Rail Development Commission
Heather Hamilton - Safety Division Coordinator
614-644-0307
heather.hamilton@dot.ohio.gov

Ohio Rail Development Commission Representative
Mott MacDonald
Zoltan Szabo
216-535-3642
zoltan.szabo@mottmac.com

Norfolk Southern Railroad
Aaron Pease
440-429-1960
aaron.pease@nscorp.com

CITY OF FRANKLIN
Nick Miller, Assistant Public Works Director
937-746-5001
nmiller@Franklinohio.org

CLEARING AND GRUBBING

ALTHOUGH THERE ARE NO TREES OR STUMPS SPECIFICALLY MARKED FOR REMOVAL WITHIN THE LIMITS OF THE PROJECT, A LUMP SUM QUANTITY IS INCLUDED IN THE GENERAL SUMMARY FOR ITEM 201, CLEARING AND GRUBBING. ALL PROVISIONS AS SET FORTH IN THE SPECIFICATIONS UNDER THIS ITEM ARE INCLUDED IN THE LUMP SUM PRICE BID FOR ITEM 201, CLEARING AND GRUBBING.

ITEM 204 - SUBGRADE COMPACTION AND PROOF ROLLING

CONSTRUCT THE SUBGRADE AS FOLLOWS AND IN THE FOLLOWING SEQUENCE:

1. SHAPE THE SUBGRADE TO WITHIN 0.2 FEET OF THE PLAN SUBGRADE ELEVATION.
2. COMPACT THE SUBGRADE ACCORDING TO C&MS 204.03.
3. PROOF ROLL THE COMPACTED SUBGRADE ACCORDING TO C&MS 204.06.
4. FINE GRADE THE SUBGRADE TO THE SPECIFIED GRADE.

ITEM 601 - CRUSHED AGGREGATE SLOPE PROTECTION, AS PER PLAN

REMOVE AND REPLACE THE EXISTING ROCK BEHIND CR-2 AND CR-3 WITH IN-KIND MATERIAL. IF POSSIBLE, REUSE THE EXISTING ROCK.

A CONTINGENCY QUANTITY HAS BEEN INCLUDED AND CARRIED TO THE SUBSUMMARY ON SHEET P.09

ITEM 601 - CRUSHED AGGREGATE SLOPE PROTECTIONS, AS PER PLAN
9 SQ. YD.

MANHOLE AND VALVES ADJUSTED TO GRADE (PRIVATELY OWNED)

ALL MANHOLES AND VALVES ENCOUNTERED IN AREAS THAT REQUIRE GRADE ADJUSTMENT WILL BE PERFORMED PRIOR TO THE APPLICATION OF THE SURFACE COURSE BY THE UTILITY OWNER. CONTACT THE UTILITY OWNER 2 WEEKS PRIOR TO WHEN THE ADJUSTMENTS ARE TO BE COMPLETED.

SURVEYING PARAMETERS

PRIMARY PROJECT CONTROL MONUMENTS GOVERN ALL POSITIONING ON ODOT PROJECTS. SEE SHEET P.02 OF THE PLANS FOR A TABLE CONTAINING PROJECT CONTROL INFORMATION.

USE THE FOLLOWING PROJECT CONTROL, VERTICAL POSITIONING, AND HORIZONTAL POSITIONING PARAMETERS FOR ALL SURVEYING ON THIS PROJECT:

PROJECT CONTROL

POSITIONING METHOD: ODOT REAL TIME NETWORK (2011) AND DIFFERENTIAL LEVELING
MONUMENT TYPE: B

VERTICAL POSITIONING

ORTHOMETRIC HEIGHT DATUM: NAVD88
GEOID: 12B

HORIZONTAL POSITIONING

REFERENCE FRAME: NAD83(2011)
ELLIPSOID: GRS80
OHIO COUNTY COORDINATE SYSTEM: WARREN
WARREN LDP PROJECTION PARAMETERS:
PROJECTION: LCC 1 PARALLEL
CENTRAL LATITUDE: N 39°24'00"
CENTRAL LONGITUDE: E 275°51'00"
FALSE NORTHING: 100,000 METERS
FALSE EASTING: 50,000 METERS
PROJECTION SCALE FACTOR: 1.000035

*THE LOW DISTORTION PROJECTION (LDP) IS A LOCAL COUNTY PROJECTION DEVELOPED BY O.D.O.T. THE DISTORTION BETWEEN GROUND AND GRID IS SO MINIMAL THAT THERE IS NO NEED FOR A SCALE FACTOR TO ADJUST BETWEEN GRID AND GROUND COORDINATES. CONTACT THE DISTRICT SURVEY DEPARTMENT FOR FURTHER INFORMATION OR QUESTIONS.

UNITS ARE IN U.S. SURVEY FEET. USE THE FOLLOWING CONVERSION FACTOR: 1 METER = 3.280833333 U.S. SURVEY FEET.

USE THE POSITIONING METHODS AND MONUMENT TYPE USED IN THE ORIGINAL SURVEY TO RESTORE ALL MONUMENTS RELATED TO PRIMARY PROJECT CONTROL THAT ARE DAMAGED OR DESTROYED BY CONSTRUCTION ACTIVITIES. RESTORE THE DAMAGED OR DESTROYED MONUMENTS IN ACCORDANCE WITH CMS 623.

BASIS OF BEARINGS
BEARINGS ARE BASED ON GRID NORTH OF THE O.D.O.T. LOW DISTORTION PROJECTION – WARREN COUNTY

SEEDING AND MULCHING

THE FOLLOWING QUANTITIES ARE PROVIDED TO PROMOTE GROWTH AND CARE OF PERMANENT SEEDED AREAS:

| | | |
|----------------------------------|------|---------|
| 659, TOPSOIL | 4 | CU. YD. |
| 659, SEEDING AND MULCHING | 30 | SQ. YD. |
| 659, REPAIR SEEDING AND MULCHING | 2 | SQ. YD. |
| 659, INTER-SEEDING | 2 | SQ. YD. |
| 659, COMMERCIAL FERTILIZER | 0.01 | TON |
| 659, LIME | 0.01 | ACRE |
| 659, WATER | 1 | M. GAL. |

SEEDING AND MULCHING SHALL BE APPLIED TO ALL AREAS OF EXPOSED SOIL BETWEEN THE RIGHT-OF-WAY LINES, AND WITHIN THE CONSTRUCTION LIMITS FOR AREAS OUTSIDE THE RIGHT-OF-WAY LINES COVERED BY WORK AGREEMENT OR SLOPE EASEMENT. QUANTITY CALCULATIONS FOR SEEDING AND MULCHING ARE BASED ON THESE LIMITS. THE SEEDING AND MULCHING QUANTITIES SHOWN ABOVE HAVE BEEN CARRIED TO THE GENERAL SUMMARY.

ITEM 608 - CURB RAMP, AS PER PLAN

IN AREAS OF INTERSECTION WHERE CURB IS REPLACED, WHEEL CHAIR RAMPS SHALL BE CONSTRUCTED TO MEET ADA REQUIREMENTS IN ACCORDANCE WITH ODOT STANDARD DRAWING BP-7.1 AND AS DIRECTED BY THE ENGINEER.

THE INTENT OF THIS ITEM IS TO INSTALL ADA CURB RAMPS WHERE INDICATED IN THIS SET OF PLANS. THE CONTRACTOR SHALL BE RESPONSIBLE FOR REMOVING THE EXISTING WALK AND/OR CURB AND GUTTER IN A MANNER THAT DOES NOT DAMAGE OTHER AREAS MEANT TO REMAIN IN PLACE (SEE CURRENT STANDARD DRAWING BP-7.1). AS THESE INSTALLATIONS ARE BEING MADE TO FIT EXISTING CONDITIONS, VARIATIONS FROM STANDARD MAY OCCUR. ANY DEVIATIONS FROM DETAIL IN THESE PLANS MUST FIRST BE APPROVED BY THE ENGINEER. RESTORATION TO EXISTING PAVEMENT AREAS IN FRONT OF THE PROPOSED CURB RAMPS SHALL BE INCLUDED IN THIS ITEM OF WORK. RESTORATION SHALL BE MADE UP TO AND INCLUDE THE SURFACE COURSE. ALL WORK, LABOR, MATERIAL, EQUIPMENT, AND INCIDENTALS NECESSARY TO COMPLETE THIS WORK SHALL BE INCLUDED IN THE UNIT PRICE BID PER SQUARE FOOT FOR ITEM 608, CURB RAMP, AS PER PLAN.

PAVEMENT REPAIR

PAVEMENT REPAIR SHALL CONSIST OF PAVEMENT REMOVED AND REPLACED TO CORRECT COUNTER SLOPE AND/OR CROSS SLOPE AT PROPOSED CURB RAMP BASES, AND/OR FOR EASE OF CONSTRUCTION.

IN ADDITION TO THE REQUIREMENT OF ODOT C&MS SECTION 253, THE CONTRACTOR SHALL REMOVE AN ADDITIONAL WIDTH OF PAVEMENT MEASURED 2 FEET FROM THE FACE OF THE CURB/GUTTER TO BE REMOVED. REFER TO THE TYPICAL SECTION BELOW FOR PAVEMENT BUILD-UP OF THE REPLACEMENT MATERIAL.

ESTIMATED QUANTITIES ARE INCLUDED IN THE SUBSUMMARY ON SHEET P.09
THE 6" AGGREGATE BASE SHALL BE INSTALLED UNDER THE CURB AND SHALL EXTEND WIDTHWISE APPROXIMATELY 10" PAST THE BACK OF CURB.

ALL OF THESE ITEMS, INCLUDING THE PAVEMENT REMOVAL, ARE INCLUDED IN THE SQ FT ITEM, CURB RAMP, AS PER PLAN.

TYPICAL SECTION: PAVEMENT REPAIR, AS PER PLAN

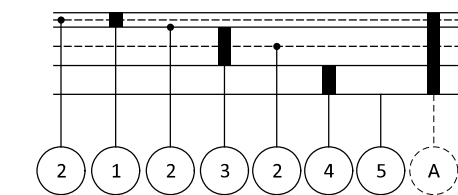

- A ITEM 202 - PAVEMENT REMOVED
- 1 ITEM 441 - 3" ASPHALT CONCRETE SURFACE COURSE, TYPE 1, (449), PG64-22 (2 LIFTS)
- 2 ITEM 407 - NON-TRACKING TACK COAT
- 3 ITEM 301 - 8" ASPHALT CONCRETE BASE, PG64-22 (2 LIFTS)
- 4 ITEM 304 - 6" AGGREGATE BASE
- 5 ITEM 204 - SUBGRADE COMPACTION

EXISTING PAVEMENT BUILD-UPS WERE NOT FOUND. REGARDLESS OF MATERIAL FOUND, BACKFILL AS SHOWN IN TYPICAL SECTION ABOVE.



WORK INSPECTION

THE CONTRACTOR SHALL PROVIDE THE PROJECT ENGINEER WITH 72-HOUR NOTICE OF ANY SIGNAL WORK TO BE PERFORMED AT THE INTERSECTION SITE(S) SO THAT INSPECTION SERVICES CAN BE SUPPLIED.

CONSTRUCTION NOISE

ACTIVITIES AND LAND USE ADJACENT TO THIS PROJECT MAY BE AFFECTED BY CONSTRUCTION NOISE. IN ORDER TO MINIMIZE ANY ADVERSE CONSTRUCTION NOISE IMPACTS, DO NOT OPERATE POWER-OPERATED CONSTRUCTION-TYPE DEVICES BETWEEN THE HOURS OF 8:00 PM AND 7:00 AM. IN ADDITION, DO NOT OPERATE AT ANY TIME ANY DEVICE IN SUCH A MANNER THAT THE NOISE CREATED SUBSTANTIALLY EXCEEDS THE NOISE CUSTOMARILY AND NECESSARILY ATTENDANT TO THE REASONABLE AND EFFICIENT PERFORMANCE OF SUCH EQUIPMENT.

COORDINATION WITH RAILROAD

THE CONTRACTOR IS RESPONSIBLE FOR ALL COORDINATION WITH NORFOLK SOUTHERN RAILROAD ON THIS PROJECT.

THE CONTRACTOR WILL NEED TO COORDINATE WITH NORFOLK SOUTHERN TO DETERMINE THE METHOD AND SCHEDULE OF INTERCONNECTION. AT MINIMUM, THE CONTRACTOR SHALL CONNECT THE PROVIDED INTERCONNECT CABLE TO THE TRAFFIC SIGNAL CONTROL CABINET. IF THE PROVIDED CABLE LENGTH IS NOT ADEQUATE, THE CONTRACTOR SHALL REPLACE IT WITH ONE CONTINUOUS CABLE OF ADEQUATE LENGTH TO COMPLETE THE CONNECTION BETWEEN THE TRAFFIC SIGNAL CONTROLLER CABINET AND THE RAILROAD BUNGALOW IN ACCORDANCE WITH SS819. SPLICES ARE NOT ACCEPTABLE.

ITEM 202 - CURB REMOVED, AS PER PLAN

SAW CUT THE EXISTING CURB FOR THE LIMITS SHOWN ON THE PLANS SUCH THAT THE CURB IS FLUSH WITH THE ADJACENT SURFACES.

GENERAL NOTES



DESIGNER
ARM

REVIEWER
SJS 06/07/24

PROJECT ID
115153

SHEET TOTAL
P.04 | 29

MAINTENANCE OF TRAFFIC SIGNAL INSTALLATION

THE CONTRACTOR SHALL BE RESPONSIBLE FOR MAINTAINING TRAFFIC SIGNAL INSTALLATIONS WITHIN THE PROJECT UNDER THE FOLLOWING CONDITION:

NEW SIGNAL INSTALLATIONS OR DEVICES, INSTALLED BY THE CONTRACTOR. THE CONTRACTOR SHALL BE RESPONSIBLE FOR MAINTENANCE OF THESE FROM THE TIME OF INSTALLATION UNTIL THE WORK IS ACCEPTED.

THE CONTRACTOR SHALL CORRECT AS QUICKLY AS POSSIBLE ALL OUTAGES OR MALFUNCTIONS. HE SHALL PROVIDE THE MAINTAINING AGENCY AND THE ENGINEER SUCH ADDRESSES AND PHONE NUMBERS WHERE HIS MAINTENANCE FORCES CAN BE CONTACTED. THE CONTRACTOR SHALL PROVIDE ONE OR MORE PERSONS TO RECEIVE ALL CALLS AND DISPATCH THE NECESSARY MAINTENANCE FORCES TO CORRECT OUTAGES. SUCH A PERSON OR PERSONS MAY BE USED TO PERFORM OTHER DUTIES AS LONG AS PROMPT ATTENTION IS GIVEN TO THESE CALLS AND A PERSON IS READILY AVAILABLE CONTINUOUSLY 24 HOURS A DAY, 7 DAYS A WEEK. ALL LAMP OUTAGES, CABLE OUTAGES, ELECTRICAL FAILURES, EQUIPMENT MALFUNCTIONS AND MISALIGNED SIGNAL HEADS SHALL BE CORRECTED TO THE SATISFACTION OF THE ENGINEER WITH THE SIGNAL BACK TO SERVICE WITHIN FOUR HOURS AFTER THE CONTRACTOR HAS BEEN NOTIFIED OF THE OUTAGE.

IN THE EVENT NEW SIGNALS ARE DAMAGED PRIOR TO ACCEPTANCE, ALL DAMAGED EQUIPMENT EXCEPT POLES AND CONTROL EQUIPMENT SHALL BE REPLACED BY THE CONTRACTOR TO THE SATISFACTION OF THE ENGINEER WITH THE SIGNAL BACK IN SERVICE WITHIN 8 HOURS AFTER THE CONTRACTOR'S NOTIFICATION OF THE OUTAGE. THE CONTRACTOR SHALL ARRANGE FOR FULL TRAFFIC CONTROL UNTIL THE SIGNAL IS BACK IN OPERATION.

IF POLES AND/OR CONTROL EQUIPMENT ARE DAMAGED AND MUST BE REPLACED, THE CONTRACTOR SHALL MAKE TEMPORARY REPAIRS AS NECESSARY TO BRING THE SIGNAL BACK INTO FULL OPERATION WITHIN THE ALLOWED 8-HOUR PERIOD, AND SHALL MAKE PERMANENT REPAIRS OR REPLACEMENT AS SOON THEREAFTER AS POSSIBLE.

NONE OF THE ABOVE SHALL BE CONSTRUED AS COLLECTIVE OR CONSECUTIVE OUTAGE TIME PERIODS AT ANY ONE LOCATION. THAT IS, WHERE MORE THAN ONE OUTAGE OCCURS AT ANY ONE LOCATION THEN THE ALLOTTED TIME LIMIT SHALL BE FOR THE WORST SINGLE OUTAGE.

WHERE OUTAGES ARE THE DIRECT RESULT OF A VEHICLE ACCIDENT THE RESPONSE OF THE CONTRACTOR SHALL BE AS OUTLINED ABOVE. THE CONTRACTOR SHALL BE RESPONSIBLE FOR COLLECTION OF ANY COMPENSATION FOR THIS WORK FROM THOSE PARTIES RESPONSIBLE FOR THE DAMAGE.

WHERE THE CONTRACTOR HAS FAILED TO, OR CANNOT RESPOND TO, AN OUTAGE OR SIGNAL EQUIPMENT MALFUNCTION, AT THE LOCATIONS WITHIN HIS RESPONSIBILITY, WITHIN PERIODS AS SPECIFIED ABOVE, THE ENGINEER MAY INVOKE THE PROVISIONS OF SECTION 105.15 AND ANY SUBSEQUENT BILLINGS TO THE STATE FOR POLICE SERVICES AND MAINTENANCE SERVICES SHALL BE DEDUCTED FROM MONIES DUE OR TO BECOME DUE THE CONTRACTOR IN ACCORDANCE WITH PROVISIONS OF SECTION 105.15.

THE CONTRACTOR SHALL PROVIDE THE MAINTENANCE SERVICE ENTIRELY WITH HIS FORCES OR HE MAY CHOOSE TO ENTER INTO A COOPERATIVE UNDERSTANDING WITH THE LOCAL MAINTAINING AGENCY TO PROVIDE THE MAINTENANCE. THE CONTRACTOR SHALL INFORM THE ENGINEER, IN WRITING, OF THE MAINTENANCE METHOD SELECTED.

MAINTENANCE OF TRAFFIC SIGNAL INSTALLATION (CONT)

THE CONTRACTOR SHALL BE RESPONSIBLE FOR ANY DAMAGE TO ANY TRAFFIC SIGNAL COMPONENTS REQUIRED TO BE HANDLED DURING THE RELOCATION OF POLES AND REVISIONS TO THE SIGNAL SYSTEM. WHEN A TRAFFIC SIGNAL MUST BE TAKEN OUT OF SERVICE BY THE CONTRACTOR, DUE TO CONSTRUCTION PROCEDURES, THIS OUTAGE SHALL NOT EXCEED 6 HOURS AND SHALL NOT INCLUDE THE HOURS OF 7:00 TO 9:00 AM AND 3:00 TO 6:00 PM. ANY SIGNALIZED INTERSECTION, WHERE THE SIGNAL IS OUT OF SERVICE DUE TO CONSTRUCTION PROCEDURES, OR DUE TO AN OUTAGE OR MALFUNCTION OF EQUIPMENT AS DESCRIBED ABOVE, SHALL BE PROTECTED, BY THE CONTRACTOR, BY THE INSTALLATION OF TEMPORARY "STOP" SIGNS.

ANY VEHICULAR TRAFFIC SIGNAL HEAD, EITHER NEW OR EXISTING WHICH WILL BE OUT OF OPERATION SHALL BE COVERED IN THE MANNER DESCRIBED IN 632.25.

THE CONTRACTOR SHALL MAINTAIN COMPLETE RECORDS OF MALFUNCTIONS INCLUDING:

1. TIME OF NOTIFICATION OF MALFUNCTION;
2. TIME OF WORK CREWS ARRIVAL TO CORRECT THE MALFUNCTION;
3. ACTIONS TAKEN TO CORRECT THE MALFUNCTION, INCLUDING A LIST OF PARTS REPAIRED OR REPLACED;
4. A DIAGNOSIS OF REASON FOR THE MALFUNCTION AND PROBABILITY OF REOCCURRENCE;
5. TIME OF COMPLETION OF THE REPAIR AND SYSTEM RESTORED TO FULL SERVICE.

A COPY OF THESE RECORDS SHALL BE PROVIDED TO THE ENGINEER WITHIN THREE (3) WORKING DAYS FOLLOWING COMPLETION OF EACH REPAIR.

ALL COSTS RESULTING FROM THE ABOVE REQUIREMENTS SHALL BE CONSIDERED TO BE INCLUDED IN THE LUMP SUM PRICE BID FOR ITEM 614, MAINTAINING TRAFFIC.

ITEM 614, MAINTAINING TRAFFIC (AT ALL TIMES)

A MINIMUM OF ONE LANE OF TRAFFIC IN EACH DIRECTION SHALL BE MAINTAINED AT ALL TIMES BY USE OF THE EXISTING PAVEMENT, FLAGGER CONTROL PER SCD MT-97.10, AND MT-97.12. MAINTAIN A MINIMUM OF 1 SIDEWALK ON EITHER SIDE OF THE ROAD AT ALL TIMES.

LANE RESTRICTIONS OR LANE REDUCTIONS SHALL NOT BE PERMITTED AFTER NORMAL WORKING HOURS. NORMAL WORKING HOURS SHALL BE THOSE HOURS DURING WHICH THE CONTRACTOR HAS A FULL COMPLEMENT OF EMPLOYEES AND EQUIPMENT ACTIVELY REMOVING AND/OR PLACING PAVEMENT MATERIALS.

IF IT IS NECESSARY TO STOP ALL TRAFFIC THE WORK SHALL BE SO ARRANGED THAT THE STOPPAGE IS LESS THAN TEN (10) MINUTES IN ANY ONE (1) THIRTY (30) MINUTE PERIOD. NO STOPPAGE OF TRAFFIC SHALL OCCUR FOR THE ERECTION OF SIGNAL SUPPORTS OR HANGING SIGNAL HEADS WITHOUT A LAW ENFORCEMENT OFFICER WITH PATROL CAR AT THE SITE FOR ASSISTANCE IN CONTROLLING TRAFFIC. IT SHALL BE THE CONTRACTOR'S RESPONSIBILITY TO PROVIDE THE SERVICES AND SCHEDULING OF SAID LAW ENFORCEMENT OFFICER WITH PATROL CAR.

LENGTH AND DURATION OF LANE CLOSURES AND RESTRICTIONS SHALL BE AT THE APPROVAL OF THE ENGINEER. IT IS THE INTENT TO MINIMIZE THE IMPACT TO THE TRAVELING PUBLIC. LANE CLOSURES OR RESTRICTIONS OVER SEGMENTS OF THE PROJECT IN WHICH NO WORK IS ANTICIPATED WITHIN A REASONABLE TIME FRAME, AS DETERMINED BY THE ENGINEER, SHALL NOT BE PERMITTED. THE LEVEL OF UTILIZATION OF MAINTENANCE OF TRAFFIC DEVICES SHALL BE COMMENSURATE WITH THE WORK IN PROGRESS.

ITEM 614, MAINTAINING TRAFFIC (AT ALL TIMES) (CONT)

ALL WORK AND TRAFFIC CONTROL DEVICES SHALL BE IN ACCORDANCE WITH C&MS 614 AND OTHER APPLICABLE PORTIONS OF THE SPECIFICATIONS, AS WELL AS THE OHIO MANUAL OF UNIFORM TRAFFIC CONTROL DEVICES. PAYMENT FOR ALL LABOR, EQUIPMENT AND MATERIALS SHALL BE INCLUDED IN THE LUMP SUM CONTRACT PRICE FOR ITEM 614, MAINTAINING TRAFFIC UNLESS SEPARATELY ITEMIZED IN THE PLANS.

NOTIFICATION OF TRAFFIC RESTRICTIONS

THROUGHOUT THE DURATION OF THE PROJECT, THE CONTRACTOR SHALL NOTIFY THE PROJECT ENGINEER IN WRITING OF ALL TRAFFIC RESTRICTIONS AND UPCOMING MAINTENANCE OF TRAFFIC CHANGES. THE CONTRACTOR SHALL ENSURE THE WRITTEN NOTIFICATION IS SUBMITTED IN A TIMELY MANNER TO ALLOW THE PROJECT ENGINEER TO MEET THE REQUIRED TIME FRAMES SET FORTH IN THE TABLE BELOW TO INFORM THE SPECIAL HAULING PERMITS SECTION (HAULING.PERMITS@DOT.OHIO.GOV) AND THE DISTRICT PUBLIC INFORMATION OFFICE (PIO). THIS NOTIFICATION SHALL BE RECEIVED BY THE PROJECT ENGINEER PRIOR TO THE PHYSICAL SETUP OF ANY APPLICABLE SIGNS OR MESSAGE BOARDS.

INFORMATION SHOULD INCLUDE, BUT IS NOT LIMITED TO, ALL CONSTRUCTION ACTIVITIES THAT IMPACT OR INTERFERE WITH TRAFFIC AND SHALL LIST THE SPECIFIC LOCATION, TYPE OF WORK, ROAD STATUS, DATE AND TIME OF RESTRICTION, DURATION OF RESTRICTION, NUMBER OF LANES MAINTAINED, NUMBER OF LANES CLOSED, MINIMUM VERTICAL CLEARANCE, MINIMUM WIDTH OF DRIVABLE PAVEMENT, DETOUR ROUTES, IF APPLICABLE, AND ANY OTHER INFORMATION REQUESTED BY THE PROJECT ENGINEER.

| NOTIFICATION TIME FRAME TABLE | | |
|---|---------------------|--|
| ITEM | DURATION OF CLOSURE | NOTICE DUE TO PERMITS AND PIO |
| LANE CLOSURES AND RESTRICTIONS | >=2 WEEKS | 14 CALENDAR DAYS PRIOR TO CLOSURE |
| | <2 WEEKS | 5 BUSINESS DAYS PRIOR TO CLOSURE |
| START OF CONSTRUCTION AND TRAFFIC PATTERN CHANGES | N/A | 14 CALENDAR DAYS PRIOR TO IMPLEMENTATION |

ANY UNFORESEEN CONDITIONS NOT SPECIFIED IN THE PLANS REQUIRING TRAFFIC RESTRICTIONS SHALL ALSO BE REPORTED TO THE PROJECT ENGINEER USING THE NOTIFICATION TIME TABLE.

WINDOW CONTRACT TABLE

WORK LIMITS

THE WORK LIMITS SHOWN ON THESE PLANS ARE FOR PHYSICAL CONSTRUCTION ONLY. PROVIDE THE INSTALLATION AND OPERATION OF ALL WORK ZONE TRAFFIC CONTROL AND WORK ZONE TRAFFIC CONTROL DEVICES REQUIRED BY THESE PLANS WHETHER INSIDE OR OUTSIDE THESE WORK LIMITS.

| DESCRIPTION OF CRITICAL WORK | CALENDAR DAYS TO COMPLETE |
|------------------------------|---------------------------|
| ALL WORK ON PROJECT | 60 DAYS |

THE CONSTRUCTION COMPLETION DATE IS 10/31/2025

DUST CONTROL

THE CONTRACTOR SHALL FURNISH AND APPLY WATER FOR DUST CONTROL AS DIRECTED BY THE ENGINEER. THE FOLLOWING ESTIMATED QUANTITIES HAVE BEEN INCLUDED FOR DUST CONTROL PURPOSES:

ITEM 616, WATER 1 M. GAL.

ITEM 614 - LAW ENFORCEMENT OFFICER (WITH PATROL CAR) FOR ASSISTANCE DURING CONSTRUCTION OPERATIONS

USE OF LAW ENFORCEMENT OFFICERS (LEOS) BY CONTRACTORS OTHER THAN THE USES SPECIFIED BELOW WILL NOT BE PERMITTED AT PROJECT COST. LEOS SHOULD NOT BE USED WHERE THE OMUTCD INTENDS THAT FLAGGERS BE USED.

IN ADDITION TO THE REQUIREMENTS OF C&MS 614 AND THE OMUTCD, A UNIFORMED LEO WITH AN OFFICIAL PATROL CAR (CAR WITH TOP-MOUNTED EMERGENCY FLASHING LIGHTS AND COMPLETE MARKINGS OF THE APPROPRIATE LAW ENFORCEMENT AGENCY) SHALL BE PROVIDED FOR THE FOLLOWING TRAFFIC CONTROL TASKS:

DURING THE ENTIRE ADVANCE PREPARATION AND CLOSURE SEQUENCE WHERE COMPLETE BLOCKAGE OF TRAFFIC IS REQUIRED.

DURING A TRAFFIC SIGNAL INSTALLATION WHEN IMPACTING THE NORMAL FUNCTION OF THE SIGNAL OR THE FLOW OF TRAFFIC, OR WHEN TRAFFIC NEEDS TO BE DIRECTED THROUGH AN ENERGIZED TRAFFIC SIGNAL CONTRARY TO THE SIGNAL DISPLAY (E.G., DIRECTING MOTORISTS THROUGH A RED LIGHT).

IN GENERAL, LEOS SHOULD BE POSITIONED IN ADVANCE OF AND ON THE SAME SIDE AS THE LANE RESTRICTION OR AT THE POINT OF ROAD CLOSURE, AND TO MANUALLY CONTROL TRAFFIC MOVEMENTS THROUGH SIGNALIZED INTERSECTIONS IN WORK ZONES.

LEOS SHOULD NOT FORGO THEIR TRAFFIC CONTROL RESPONSIBILITIES TO APPREHEND MOTORISTS FOR ROUTINE TRAFFIC VIOLATIONS. HOWEVER, IF A MOTORIST'S ACTIONS ARE CONSIDERED TO BE RECKLESS, THEN PURSUIT OF THE MOTORIST IS APPROPRIATE.

THE LEOS WORK AT THE DIRECTION OF THE CONTRACTOR. THE CONTRACTOR IS RESPONSIBLE FOR SECURING THE SERVICES OF THE LEOS WITH THE APPROPRIATE AGENCIES AND COMMUNICATING THE INTENTIONS OF THE PLANS WITH RESPECT TO DUTIES OF THE LEOS. THE ENGINEER SHALL HAVE FINAL CONTROL OVER THE LEOS' DUTIES AND PLACEMENT, AND WILL RESOLVE ANY ISSUES THAT MAY ARISE BETWEEN THE TWO PARTIES.

ENSURE PROVIDED LEOS HAVE BEEN TRAINED APPROPRIATE TO THE JOB DECISIONS THEY ARE REQUIRED TO MAKE WHILE ON THE PROJECT, IN ACCORDANCE WITH C&MS 614.03.

THE LEO SHALL REPORT IN TO THE CONTRACTOR PRIOR TO THE START OF THE SHIFT, IN ORDER TO RECEIVE INSTRUCTIONS REGARDING THE SPECIFIC WORK ASSIGNMENTS DURING HIS/HER SHIFT. THE LEO IS EXPECTED TO STAY AT THE PROJECT SITE FOR THE ENTIRE DURATION OF HIS/HER SHIFT. THE LEO SHALL REPORT TO THE CONTRACTOR AT THE END OF HIS/HER SHIFT. SHOULD IT BE NECESSARY TO LEAVE THE PROJECT SITE, THE LEO SHALL NOTIFY THE ENGINEER. THE CONTRACTOR SHALL PROVIDE THE LEO WITH A TWO-WAY COMMUNICATION DEVICE WHICH SHALL BE RETURNED TO THE CONTRACTOR AT THE END OF HIS/HER SHIFT.

LEOS (WITH PATROL CAR) REQUIRED BY THE TRAFFIC MAINTENANCE TASKS ABOVE SHALL BE PAID FOR ON A UNIT PRICE (HOURLY) BASIS UNDER ITEM 614, LAW ENFORCEMENT OFFICER (WITH PATROL CAR) FOR ASSISTANCE. THE FOLLOWING ESTIMATED QUANTITIES HAVE BEEN CARRIED TO THE GENERAL SUMMARY:

ITEM 614, LAW ENFORCEMENT OFFICER WITH PATROL CAR FOR ASSISTANCE 48 HOURS

THE HOURS PAID SHALL INCLUDE ANY MINIMUM SHOW-UP TIME REQUIRED BY THE LAW ENFORCEMENT AGENCY INVOLVED.

ANY ADDITIONAL COSTS (ADMINISTRATIVE OR OTHERWISE) INCURRED BY THE CONTRACTOR TO OBTAIN THE SERVICES OF A LEO ARE INCLUDED WITH THE BID UNIT PRICE FOR ITEM 614, LAW ENFORCEMENT OFFICER WITH PATROL CAR FOR ASSISTANCE. THE QUANTITY HAS BEEN CARRIED TO THE GENERAL SUMMARY.

ITEM 900, SPECIAL - RAILROAD FLAGGING SERVICES

FLAGGING FOR WORK ON RAILROAD RIGHT OF WAY SHALL BE COORDINATED, OBTAINED AND PAID FOR BY THE CONTRACTOR. FLAGGING SHALL BE PROVIDED BY THE CONTRACTOR WHENEVER REQUIRED BY THE NORFOLK SOUTHERN SPECIAL PROVISIONS FOR THE PROTECTION OF RAILWAY INTEREST. NORFOLK SOUTHERN SHALL APPROVE THE FLAGGING SERVICE PROVIDER AND THEIR STAFF.

SEE ADDITIONAL NS REQUIREMENTS IN THE "SPECIAL CLAUSES IN THE PROPOSAL". REFER TO DRAWING P6/22 UNDER ITEM 900-SPECIAL-RAILROAD FLAGGING SERVICES.

NORFOLK SOUTHERN HAS THE SOLE AUTHORITY TO DETERMINE THE NEED FOR PROTECTION SERVICES TO PROTECT ITS OPERATIONS IN GENERAL. THE REQUIREMENTS OF SUCH SERVICES WILL BE WHENEVER THE CONTRACTOR'S PERSONNEL OR EQUIPMENT ARE OR ARE LIKELY TO BE, WORKING ON THE RAILROAD'S RIGHT OF WAY, OR ACROSS, OVER, ADJACENT TO, OR UNDER A TRACK, OR WHEN SUCH WORK HAS DISTURBED OR IS LIKELY TO DISTURB A RAILROAD STRUCTURE OR THE RAILROAD ROADBED OR SURFACE AND ALIGNMENT OF ANY TRACK TO SUCH EXTENT THAT THE MOVEMENT OF TRAINS MUST BE CONTROLLED BY FLAGGING.

THE TOTAL DOLLARS IN THE ESTIMATED QUANTITIES IS BASED UPON AN ESTIMATE OF TOTAL FLAGGING DOLLARS NEEDED TO COMPLETE THE PLANNED WORK.

ONLY THE FOLLOWING CERTIFIED FLAGGING PROVIDERS ARE ACCEPTABLE BY NORFOLK SOUTHERN:

R&R CONSULTING TEAM
DAVID N. CRAFT
CO-OWNER & PRESIDENT
R&R CONSULTING TEAM LLC.
P.O. BOX 4739
HARRISBURG, PA 17111
717-497-4373 (CELL)
775-521-2495 (E-FAX)
dcraft@rrconsultingteam.com
www.rrconsultingteam.com

RAILROAD CONSULTANTS
STEVE LLOYD (VP BUSINESS DEVELOPMENT)
(615) 542-8901

RAILPROS
1320 GREENWAY DR., SUITE 490
IRVING, TX 75038
(877) 315-0513
[HTTP://WWW.RAILPROS.COM/SERVICES-CATEGORY/FIELD-SERVICES/](http://WWW.RAILPROS.COM/SERVICES-CATEGORY/FIELD-SERVICES/)

PAYMENT FOR CERTIFIED FLAGGING PROVIDERS WILL BE MADE PER ITEM 900, RAILROAD FLAGGING SERVICES, EACH BASED UPON THE INVOICES RECEIVED FROM THE FLAGGING SERVICE FOR THE DOLLARS USED, INCLUDING A FIVE PERCENT MARKUP FOR CONTRACTOR OVERHEAD FOR ADMINISTERING THE CONTRACT WITH THE FLAGGING SERVICE. AN ESTIMATED QUANTITY OF \$5000 HAS BEEN CARRIED TO THE GENERAL SUMMARY.

IN THE EVENT THE PROJECT IS DELAYED DUE TO RAILROAD FLAGGER AVAILABILITY, THE CONTRACTOR WILL PROVIDE DOCUMENTATION SUPPORTING THEIR EFFORTS TO SCHEDULE A FLAGGER FROM THE FLAGGING SERVICE.

DESIGN AGENCY



DESIGNER
DLW

REVIEWER
SJS 06/07/24

PROJECT ID
115153



SHEET TOTAL
P.06 | 29

WAR-S RIVER & S MAIN NS

MODEL: Sheet_SurvFl_PAPER SIZE: 17x11 (in.) DATE: 6/7/2024 TIME: 2:07:44 PM USER: 02676
 X:\4012500\220106\1115315_WAR-STW-GES ORDC 2022\115153_WAR-S River & S Main NS\400-Engineering\Roadway\Sheets\115153_GS001.dgn

| REF NO. | SHEET NO. | STATION TO STATION | | | | 201 | 202 | 202 | 202 | 202 | 452 | 601 | 608 | 608 | | 609 | 609 | | | 659 | 659 | 659 | 659 | 659 | 659 | |
|-----------------------------------|-----------|--------------------|----|-----------|----|-----|-----|-----|-----|-----|-----|-----|-----|-----|----|-----|-----|--|--|-----|-----|-----|-----|------|------|------|
| | | | | | | LS | SY | SF | FT | FT | SY | SY | SF | SF | | FT | FT | | | CY | SY | SY | SY | TON | ACRE | MGAL |
| | 3 | GENERAL NOTES | | | | LS | | | | | | 9 | | | | | | | | 4 | 30 | 2 | 2 | 0.01 | 0.01 | 1 |
| CR-1 | 10 | 99+97.00 | LT | 100+07.00 | LT | | 5 | | | | | | 52 | | | | | | | | | | | | | |
| W-1 | 10 | 99+97.00 | LT | 100+02.00 | LT | | | 47 | | | | 50 | | | | | | | | | | | | | | |
| R-1 | 10 | 100+18.00 | LT | 100+19.00 | LT | | | | 2 | | | | | | | | | | | | | | | | | |
| CR-2 | 10 | 100+45.00 | LT | 100+55.00 | LT | | | 71 | | | | | 103 | | | | | | | | | | | | | |
| CR-3 | 10 | 100+49.00 | LT | 100+54.00 | LT | | | 70 | | | | | 68 | | | | | | | | | | | | | |
| C-1 | 10 | 100+45.00 | LT | 100+59.00 | LT | | | | 38 | | | | | | 28 | | | | | | | | | | | |
| W-2 | 10 | 100+54.00 | LT | 100+59.00 | LT | | | 26 | | | | 25 | | | | 5 | | | | | | | | | | |
| CR-4 | 10 | 100+50.00 | RT | 100+55.00 | RT | | | 76 | | | | | 65 | | | | | | | | | | | | | |
| W-3 | 10 | 100+50.00 | RT | 100+58.00 | RT | | | 90 | | | | 90 | | | | | | | | | | | | | | |
| CR-5 | 10 | 99+97.00 | LT | 100+03.00 | LT | | | 35 | | | | | 35 | | | | | | | | | | | | | |
| W-4 | 10 | 99+97.00 | RT | 100+02.00 | RT | | | 50 | | | | 50 | | | | | | | | | | | | | | |
| CR-6 | 10 | 104+58.00 | RT | 104+63.00 | RT | | | 32 | | | | | 29 | | | | | | | | | | | | | |
| CR-7 | 10 | 104+58.00 | RT | 104+68.00 | RT | | | 51 | | | | | 57 | | | | | | | | | | | | | |
| C-2 | 10 | 104+53.00 | RT | 104+68.00 | RT | | | | 37 | 5 | | | | | 26 | | | | | | | | | | | |
| W-5 | 10 | 104+53.00 | RT | 104+58.00 | RT | | | 25 | | | | 25 | | | | 5 | | | | | | | | | | |
| W-6 | 10 | 104+58.00 | RT | 104+64.00 | RT | | | 103 | | | | 75 | | | | 6 | | | | | | | | | | |
| W-7 | 10 | 104+58.00 | RT | 104+64.00 | RT | | | 21 | | | | 21 | | | | 4 | | | | | | | | | | |
| CR-8 | 10 | 105+08.00 | RT | 105+19.00 | RT | | | 72 | 8 | | | | 72 | | | | | | | | | | | | | |
| TOTALS CARRIED TO GENERAL SUMMARY | | | | | | LS | 5 | 769 | 83 | 2 | 5 | 9 | 336 | 481 | | 54 | 20 | | | 4 | 30 | 2 | 2 | 0.01 | 0.01 | 1 |

ROADWAY SUBSUMMARY

DESIGN AGENCY

 CLIENT

 DESIGNER
ARM
 REVIEWER
 SJS 06/07/24
 PROJECT ID
115153
 SHEET TOTAL
 P.09 | 29

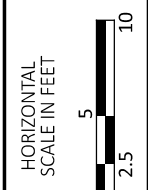
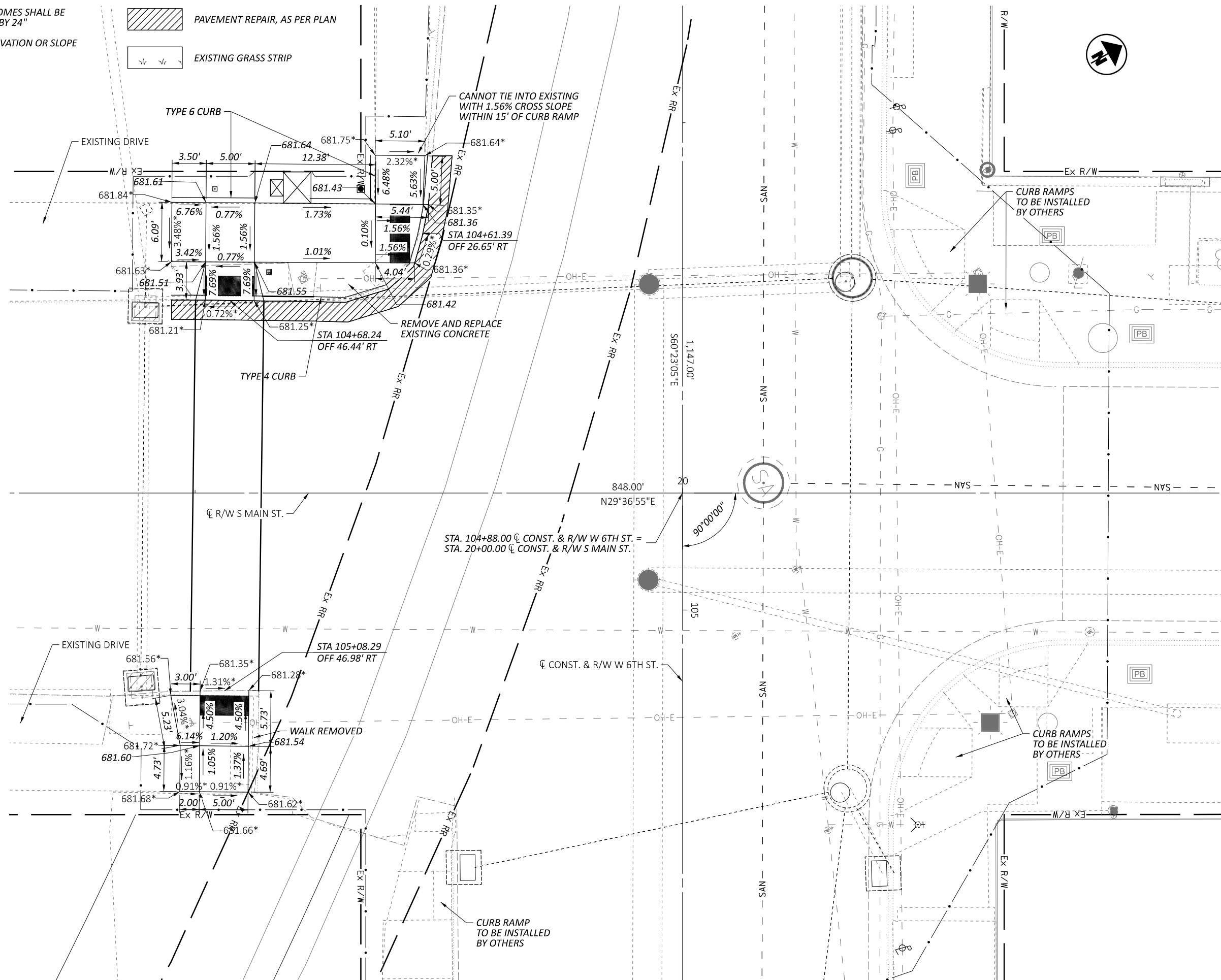
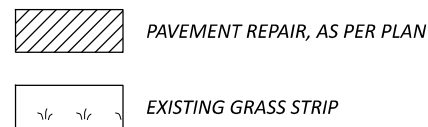
NOTE: ALL TRUNCATED DOMES SHALL BE THE RAMP WIDTH BY 24"

* INDICATES EXISTING ELEVATION OR SLOPE



CURB RAMP DETAILS
 W 6TH ST AND S MAIN ST

| | |
|------------------------|-------|
| DESIGN AGENCY | |
| Mead & Hunt | |
| CLIENT | |
| | |
| DESIGNER | |
| ARM | |
| REVIEWER | |
| SJS 06/07/24 | |
| PROJECT ID | |
| 115153 | |
| SHEET | TOTAL |
| P.12 | 29 |

| REF NO. | SHEET NO. | LOCATION | STATION | SIDE | CODE | SIZE (INCHES) | 630 | | 630 | | 630 | | 630 | | 631 | |
|-----------------------------------|-----------|--------------------|----------|------|----------------------|---------------------|------------------------------------|---|------------------|---|---|--|-----|--|-----|--|
| | | | | | | | GROUND MOUNTED SUPPORT, NO. 3 POST | SIGN HANGER ASSEMBLY, MAST ARM, AS PER PLAN | SIGN, FLAT SHEET | REMOVAL OF GROUND MOUNTED SIGN AND DISPOSAL | REMOVAL OF GROUND MOUNTED POST SUPPORT AND DISPOSAL | INTERNALLY ILLUMINATED FIXED MESSAGE SIGN, AS PER PLAN | | | | |
| | | | | | | | FT | EACH | SF | EACH | EACH | EACH | | | | |
| SR-1 | 15 | SIXTH STREET | 101+60 | LT | | | | | | | 2 | 1 | | | | |
| SR-2 | 15 | SIXTH STREET | 101+20 | RT | | | | | | | 2 | 1 | | | | |
| SR-3 | 15 | SIXTH STREET | 104+40 | RT | | | | | | | 2 | 1 | | | | |
| SR-4 | 15 | SIXTH STREET | 104+55 | RT | | | | | | | 2 | 1 | | | | |
| SR-5 | 15 | SIXTH STREET | 104+60 | RT | | | | | | | 1 | 1 | | | | |
| SR-6 | 15 | SIXTH STREET | 104+60 | RT | | | | | | | 2 | 1 | | | | |
| SR-7 | 15 | SIXTH STREET | 105+10 | RT | | | | | | | 2 | 1 | | | | |
| SR-8 | 15 | SIXTH STREET | 105+10 | RT | | | | | | | 1 | 1 | | | | |
| SR-9 | 15 | SIXTH STREET | 105+30 | LT | | | | | | | 2 | 1 | | | | |
| SR-10 | 15 | SIXTH STREET | 104+60 | LT | | | | | | | 2 | 1 | | | | |
| S-1 | 16 | SIXTH STREET | 103+20 | RT | W10-1-36 R8-3a-24 | 36" DIA. 24"X30" | 13.5 | | 9.0 5.0 | | | | | | | |
| S-2 | 16 | SIXTH STREET | 104+18 | RT | R10-6-24 | 24"X36" | 13.5 | | 5.0 | | | | | | | |
| S-3 | 16 | SIXTH STREET | 102+65 | LT | R6-1L-36 R6-1R-36 | 36"X12" 36"X12" | 11.5 | | 3.0 3.0 | | | | | | | |
| S-4 | 16 | SIXTH STREET | 102+90 | LT | W10-1-36 | 36" DIA. | 13.5 | | 9.0 | | | | | | | |
| S2 | 22 | RIVER & SIXTH INT. | MAST ARM | | | | | | | | | | | | 1 | |
| S3 | 22 | RIVER & SIXTH INT. | MAST ARM | | | | | | | | | | | | 1 | |
| S4 | 22 | RIVER & SIXTH INT. | MAST ARM | | | | | | | | | | | | 1 | |
| S2 | 26 | MAIN & SIXTH INT. | MAST ARM | | | | | | | | | | | | 1 | |
| S3 | 26 | MAIN & SIXTH INT. | MAST ARM | | | | | | | | | | | | 1 | |
| TOTALS CARRIED TO GENERAL SUMMARY | | | | | | | 52.0 | 5 | 34.0 | 18 | 10 | 5 | | | | |

SIGNING SUBSUMMARY

DESIGN AGENCY
Mead & Hunt
 CLIENT



DESIGNER
DLW



REVIEWER
SJS 06/07/24

PROJECT ID
115153

SHEET TOTAL
 P.13 | 29

| REF NO. | SHEET NO. | STATION TO STATION | | | 642 | 642 | 644 | | 644 | | 644 | | 644 | | 644 | | | | | | |
|-----------------------------------|-----------|--------------------|-----------|-----------|-----------------------------|-----------------------------|----------------------------------|------|-----------|-----|---------------------|------|---------------|------|-------------------------|-----|-------------------------|--|--|-----|--|
| | | | | | REMOVAL OF PAVEMENT MARKING | REMOVAL OF PAVEMENT MARKING | CENTER LINE, DOUBLE SOLID YELLOW | | STOP LINE | | CROSSWALK LINE, 12" | | EDGE LINE, 6" | | RAILROAD SYMBOL MARKING | | DOTTED LINE, 6", YELLOW | | | | |
| | | | | | FT | EACH | MILE | | FT | FT | | MILE | | EACH | | FT | | | | | |
| R-1 | 15 | RIVER | 10+40 | TO 10+35 | 22 | | | | | | | | | | | | | | | | |
| R-2 | 15 | RIVER | 10+36 | 10+27 | 77 | | | | | | | | | | | | | | | | |
| R-3 | 15 | SIXTH | 100+61 | | 21 | | | | | | | | | | | | | | | | |
| R-4 | 15 | SIXTH | 100+49 | | 92 | | | | | | | | | | | | | | | | |
| R-5 | 15 | SIXTH | 100+49 | 104+54 | 393 | | | | | | | | | | | | | | | | |
| R-6 | 15 | SIXTH | 104+10 | 104+54 | 42 | | | | | | | | | | | | | | | | |
| R-7 | 15 | SIXTH | 104+15 | 104+45 | | 2 | | | | | | | | | | | | | | | |
| R-8 | 15 | SIXTH | 104+54 | | 25 | | | | | | | | | | | | | | | | |
| R-9 | 15 | SIXTH | 104+61 | | 96 | | | | | | | | | | | | | | | | |
| R-10 | 15 | MAIN | 19+66 | 19+74 | 105 | | | | | | | | | | | | | | | | |
| CW-1 | 16 | RIVER | 9+58.36 | 9+55.54 | | | | | | 77 | | | | | | | | | | | |
| CW-2 | 16 | SIXTH | 100+50.40 | 100+57.38 | | | | | | 93 | | | | | | | | | | | |
| SL-1 | 16 | RIVER | 9+51.00 | | | | | | 26 | | | | | | | | | | | | |
| SL-2 | 16 | SIXTH | 100+61 | | | | | | 11 | | | | | | | | | | | | |
| CL-1 | 16 | SIXTH | 100+61 | 104+17 | | | | 0.07 | | | | | | | | | | | | | |
| CL-2 | 16 | SIXTH | 101+01 | 104+17 | | | | 0.06 | | | | | | | | | | | | | |
| SL-3 | 16 | SIXTH | 104+17 | | | | | | 13 | | | | | | | | | | | | |
| CW-3 | 16 | SIXTH | 14+59.19 | 104+69.64 | | | | | | 95 | | | | | | | | | | | |
| CW-4 | 16 | MAIN | 19+48.46 | 19+47.92 | | | | | | | | | | | | | | | | | |
| DL-1 | 16 | SIXTH | 104+17 | 105+32 | | | | | | | | | | | | | | | | 114 | |
| RR-1 | 16 | SIXTH | 102+94.65 | | | | | | | | | | | 1 | | | | | | | |
| RR-2 | 16 | SIXTH | 103+17.34 | | | | | | | | | | | | | | | | | | |
| EW-1 | 16 | SIXTH | 100+61 | 102+16 | | | | | | | 0.02 | | | 1 | | | | | | | |
| SL-4 | 16 | SIXTH | 10+94.35 | | | | | | 13 | | | | | | | | | | | | |
| TOTALS CARRIED TO GENERAL SUMMARY | | | | | 873 | 2 | 0.13 | | 63 | 265 | | 0.02 | | 2 | | 114 | | | | | |

PAVEMENT MARKING SUBSUMMARY

DESIGN AGENCY

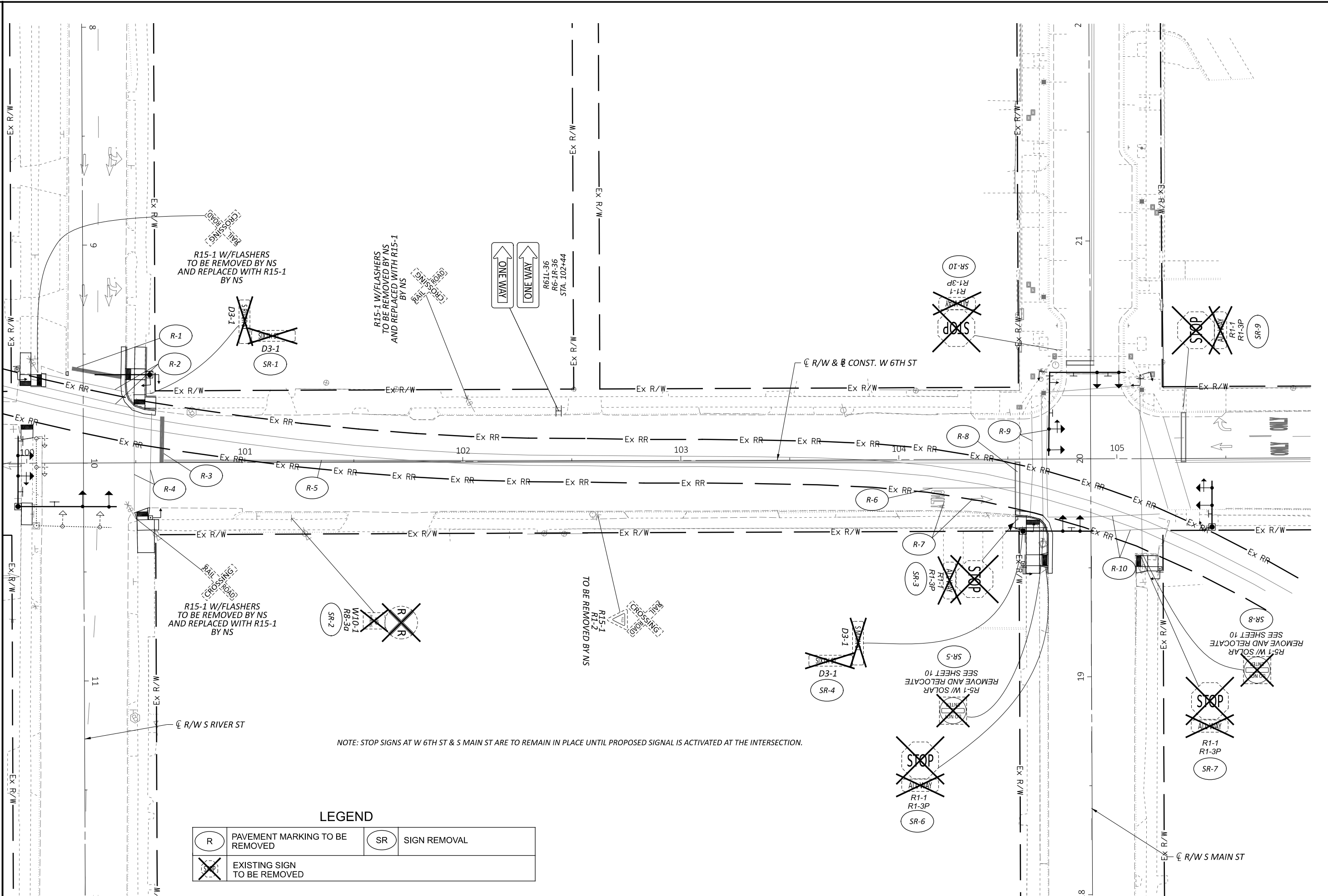
 CLIENT

 DESIGNER
 DLW
 REVIEWER
 SJS 06/07/24
 PROJECT ID
 115153
 SHEET TOTAL
 P.14 | 29

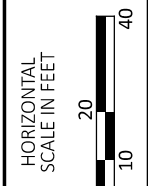

NOTE: STOP SIGNS AT W 6TH ST & S MAIN ST ARE TO REMAIN IN PLACE UNTIL PROPOSED SIGNAL IS ACTIVATED AT THE INTERSECTION.

LEGEND

| | | | |
|--|--------------------------------|--|--------------|
| | PAVEMENT MARKING TO BE REMOVED | | SIGN REMOVAL |
| | EXISTING SIGN TO BE REMOVED | | |



SIGNING AND PAVEMENT MARKING REMOVAL PLAN
 WEST 6TH STREET

DESIGN AGENCY
Mead & Hunt
 CLIENT

DESIGNER
 TK

REVIEWER
 DLW 05/31/24

PROJECT ID
 115153

SHEET TOTAL
 P.15 29

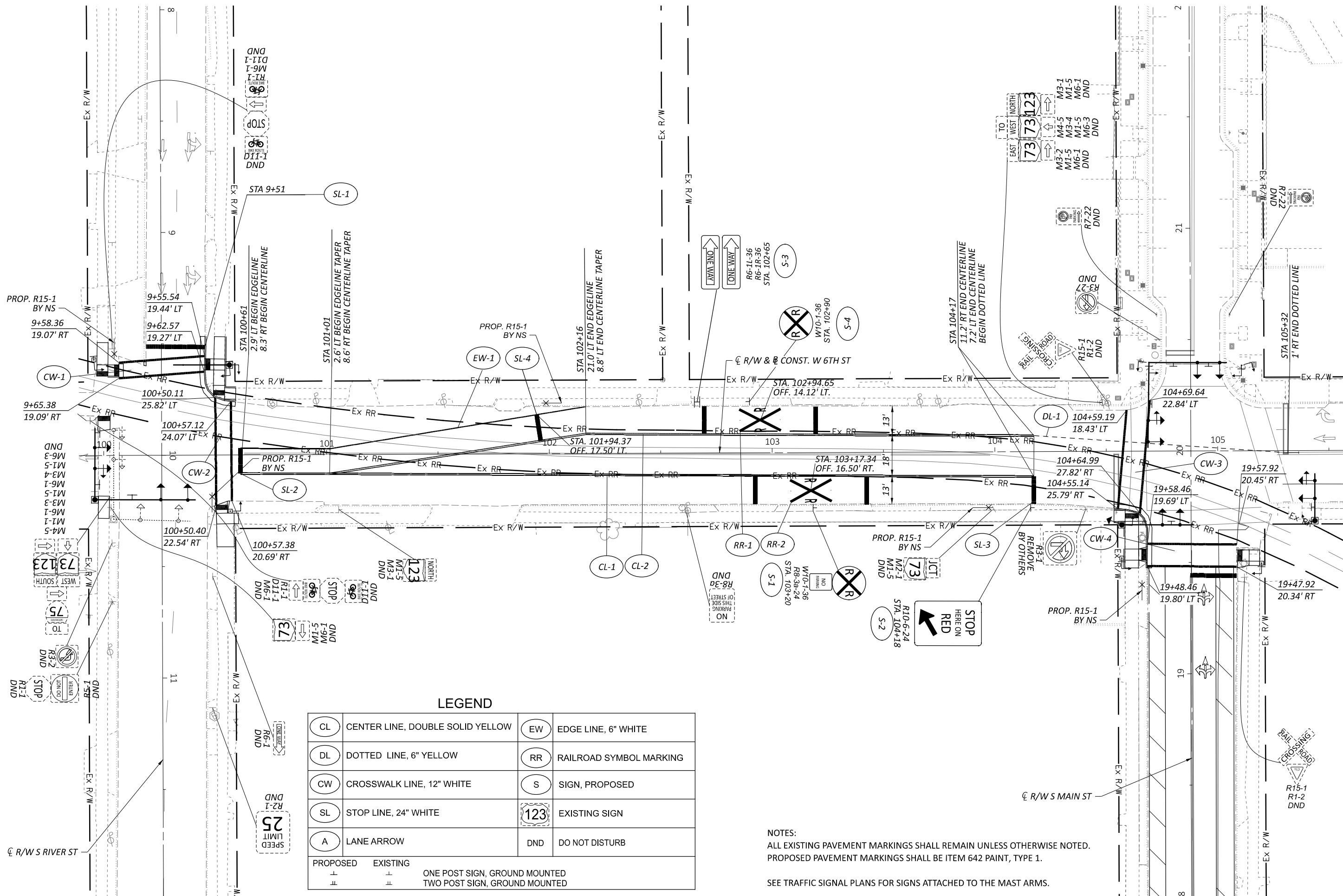

LEGEND

| | | | |
|----------|----------------------------------|-------------------------------|-------------------------|
| CL | CENTER LINE, DOUBLE SOLID YELLOW | EW | EDGE LINE, 6" WHITE |
| DL | DOTTED LINE, 6" YELLOW | RR | RAILROAD SYMBOL MARKING |
| CW | CROSSWALK LINE, 12" WHITE | S | SIGN, PROPOSED |
| SL | STOP LINE, 24" WHITE | 123 | EXISTING SIGN |
| A | LANE ARROW | DND | DO NOT DISTURB |
| PROPOSED | EXISTING | ONE POST SIGN, GROUND MOUNTED | |
| ± | ± | TWO POST SIGN, GROUND MOUNTED | |

NOTES:
 ALL EXISTING PAVEMENT MARKINGS SHALL REMAIN UNLESS OTHERWISE NOTED.
 PROPOSED PAVEMENT MARKINGS SHALL BE ITEM 642 PAINT, TYPE 1.
 SEE TRAFFIC SIGNAL PLANS FOR SIGNS ATTACHED TO THE MAST ARMS.

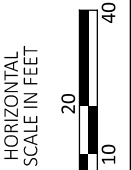

SIGNING AND MARKING PLANS
 WEST 6TH STREET

DESIGN AGENCY
Mead & Hunt
 CLIENT

DESIGNER
 TK

REVIEWER
 DLW 05/31/24

PROJECT ID
 115153

SHEET TOTAL
 P.16 29

SIGNAL ACTIVATION

PRIOR TO ACTIVATING THE NEW TRAFFIC SIGNAL TO STOP-AND-GO MODE AND/OR REMOVING THE EXISTING TRAFFIC SIGNAL FROM SERVICE, ALL ITEMS IN THE PROPOSED SIGNAL PLAN SHALL BE FULLY COMPLETED, (I.E., VEHICLE DETECTION, PEDESTRIAN SIGNAL HEADS, ETC.) IF THERE ARE CONSTRUCTABILITY ISSUES (I.E., ROADWAY WIDENING, ETC.) THAT PREVENT THE SIGNAL FROM BEING COMPLETED PRIOR TO ACTIVATION, IT SHALL BE BROUGHT TO THE ATTENTION OF THE CITY OF FRANKLIN ENGINEER. THE CITY OF FRANKLIN ENGINEER WILL THEN REVIEW, APPROVE OR REJECT PROPOSALS TO ACTIVATE THE TRAFFIC SIGNAL PRIOR TO COMPLETION.

THE CONTRACTOR SHALL NOTIFY THE PROJECT ENGINEER AND THE CITY OF FRANKLIN ENGINEER AT LEAST 10 WORKING DAYS PRIOR TO SCHEDULING THE FINAL INSPECTION OF THE SIGNAL INSTALLATION. FINAL INSPECTION IS NOT CONSIDERED COMPLETE UNTIL THE CITY OF FRANKLIN TRAFFIC PERSONNEL INSPECT THE TRAFFIC SIGNAL AND ISSUE WRITTEN APPROVAL. IF ISSUES ARE FOUND DURING THE FINAL INSPECTION THAT EFFECT THE SAFETY OF THE TRAVELING PUBLIC AND/OR THE EFFICIENCY OF THE INTERSECTION, THE SIGNAL SHALL NOT BE ACTIVATED ON THE PROPOSED DATE. ANY PUNCH LIST ITEMS THAT ARE FOUND SHALL BE CORRECTED AND REINSPECTED BY CITY OF FRANKLIN TRAFFIC PERSONNEL PRIOR TO FINAL ACCEPTANCE. THE CITY OF FRANKLIN SHALL ONLY ASSUME DAY TO DAY MAINTENANCE OF THE TRAFFIC SIGNAL AFTER FINAL WRITTEN ACCEPTANCE HAS BEEN ISSUED.

GUARANTEE

THE CONTRACTOR SHALL GUARANTEE THAT THE TRAFFIC CONTROL SYSTEM INSTALLED AS PART OF THIS CONTRACT SHALL OPERATE SATISFACTORILY FOR A PERIOD OF 90 DAYS FOLLOWING COMPLETION OF THE 10-DAY PERFORMANCE TEST. IN THE EVENT OF UNSATISFACTORY OPERATION, THE CONTRACTOR SHALL CORRECT FAULTY INSTALLATIONS, MAKE REPAIRS AND REPLACE DEFECTIVE PARTS WITH NEW PARTS OF EQUAL OR BETTER QUALITY.

EQUIPMENT, MATERIAL AND LABOR COSTS INCURRED IN CORRECTING AN UNSATISFACTORY OPERATION SHALL BE BORNE BY THE CONTRACTOR.

THE GUARANTEE SHALL COVER THE FOLLOWING ITEMS OF THE TRAFFIC CONTROL SYSTEM: CONTROLLER, CABINET, UNINTERRUPTIBLE POWER SUPPLY, VEHICLE DETECTION EQUIPMENT, LED LAMP UNITS, NETWORK AND COMMUNICATION/ INTERCONNECT EQUIPMENT.

CUSTOMARY MANUFACTURER'S GUARANTEES FOR THE FOREGOING ITEMS SHALL BE TURNED OVER TO THE STATE OR THE MAINTAINING AGENCY FOLLOWING ACCEPTANCE OF THE EQUIPMENT.

THE COST OF GUARANTEEING THE TRAFFIC CONTROL SYSTEM WILL BE INCIDENTAL TO AND INCLUDED IN THE CONTRACT UNIT PRICE OF THE VARIOUS ITEMS MAKING UP THE SYSTEM.

625 ARC FLASH CALCULATIONS AND LABEL, SIGNAL CONTROLLER

FOR THE FOLLOWING LOCATION(S), PERFORM AND SUBMIT ARC FLASH HAZARD CALCULATIONS, PREPARE THE NECESSARY LABEL, AND AFIX THE LABEL TO THE ELECTRICAL DEVICE PER SS 825.

LOCATIONS:

- SIGNAL CONTROLLER AT S 6TH ST/S RIVER ST INTERSECTION
- SIGNAL CONTROLLER AT S 6TH ST/S MAIN ST INTERSECTION

POWER SUPPLY FOR TRAFFIC SIGNALS

ELECTRIC POWER SHALL BE OBTAINED FROM DUKE ENERGY AT THE LOCATION INDICATED ON THE PLANS. POWER SUPPLIED SHALL BE 120/240 VOLTS FOR THE SIGNALS.

GROUNDING AND BONDING

THE REQUIREMENTS OF THE CONSTRUCTION AND MATERIALS SPECIFICATIONS (C&MS) AND THE TC SERIES OF STANDARD CONSTRUCTION DRAWINGS ARE MODIFIED AS FOLLOWS: ALL METALLIC PARTS CONTAINING ELECTRICAL CONDUCTORS SHALL

- A. ALL METALLIC PARTS CONTAINING ELECTRICAL CONDUCTORS SHALL BE PERMANENTLY JOINED TO FORM AN EFFECTIVE GROUND FAULT CURRENT PATH BACK TO THE GROUNDED CONDUCTOR IN THE POWER SERVICE DISCONNECT SWITCH.

PROVIDE AN EQUIPMENT GROUNDING CONDUCTOR IN METALLIC CONDUITS (725.04) IN ADDITION TO THE CONDUCTORS SPECIFIED AND BOND THE CONDUIT TO THIS GROUNDING CONDUCTOR.

- B. WHEN AN EQUIPMENT GROUNDING CONDUCTOR IS REQUIRED IN PLASTIC CONDUIT (725.05), THE INSTALLATION SHALL INCLUDE A SEPARATE EQUIPMENT GROUNDING CONDUCTOR IN ADDITION TO THE CONDUCTORS SPECIFIED.

- C. METALLIC CONDUIT CARRYING THE LOOP WIRES FROM IN THE PAVEMENT TO THE PULL BOX SPLICE LOCATION WILL ONLY BE BONDED AT THE PULL BOX END, AND WILL NOT CONTAIN AN EQUIPMENT GROUNDING CONDUCTOR.

- D. IF MULTIPLE CONDUIT RUNS BEGIN AND END AT THE SAME POINTS, ONLY ONE EQUIPMENT GROUNDING CONDUCTOR IS REQUIRED.

- E. IF AN EQUIPMENT GROUNDING CONDUCTOR IS NEEDED IN CONDUIT BETWEEN SIGNALIZED INTERSECTIONS FOR UNDERGROUND INTERCONNECT CABLE, THE GROUNDING SYSTEM FOR EACH SIGNALIZED INTERSECTION WILL BE SEPARATED ABOUT MIDWAY BETWEEN THE INTERSECTIONS.

- F. THE MESSENGER WIRE AT SIGNALIZED INTERSECTIONS WILL BE USED AS THE CONDUCTIVE PATH FROM CORNER TO CORNER IF CONDUIT IS NOT PROVIDED UNDER THE ROADWAY. WHEN CONDUIT CONNECTS THE CORNERS OF AN INTERSECTION, AN EQUIPMENT GROUNDING CONDUCTOR SHALL BE USED IN THE CONDUIT.

2. CONDUITS.

- A. THE 725.04 CONDUIT SHALL HAVE GROUNDING BUSHINGS INSTALLED AT ALL TERMINATION POINTS. THE BUSHING MATERIAL SHALL BE COMPATIBLE WITH GALVANIZED STEEL CONDUIT AND THE GROUNDING LUG MATERIAL SHALL BE COMPATIBLE FOR SWITCH COPPER WIRE. THREADED OR COMPRESSION TYPE BUSHINGS MAY BE USED.

- B. THE 725.05 CONDUIT SHALL HAVE THE INSIDE AND OUTSIDE DIAMETERS OF THE CONDUIT DEBURRED AT ALL TERMINATION POINTS.

- C. BOTH ENDS OF METALLIC CONDUIT SHALL BE BONDED TO THE EQUIPMENT GROUNDING CONDUCTOR.

- D. METALLIC CONDUIT MAY BE BONDED TO METALLIC BOXES THROUGH THE USE OF CONDUIT FITTINGS UL APPROVED FOR THIS TYPE OF CONNECTION, WITH THE BOX BONDED TO THE EQUIPMENT GROUNDING CONDUCTOR.

3. WIRE FOR GROUNDING AND BONDING.

- A. USE INSULATED, COPPER WIRE FOR THE EQUIPMENT GROUNDING CONDUCTOR. BONDING JUMPERS IN BOXES AND ENCLOSURES MAY BE BARE OR INSULATED COPPER WIRE. WIRE SIZE SHALL BE AS FOLLOWS:

- I. USE 4 AWG BETWEEN THE POWER SERVICE AND SUPPORTS, POLES, PEDESTALS, CONTROLLER OR FLASHER CABINETS.

GROUNDING AND BONDING (CONT)

- II. USE A MINIMUM 8 AWG BETWEEN LOOP DETECTOR PULL BOXES AND THE FIRST CONDUIT THAT REQUIRES A LARGER SIZE AS SPECIFIED IN 3.A.I ABOVE.

- III. USE A MINIMUM 8 AWG BETWEEN THE "PREPARE TO STOP WHEN FLASHING" INSTALLATION (INCLUDING SUPPORT) AND THE FIRST CONDUIT THAT REQUIRES A LARGER SIZE AS SPECIFIED IN 3.A.I ABOVE.

- IV. THE INSULATION SHALL BE GREEN OR GREEN WITH YELLOW STRIPE(S). FOR 4 AWG OR LARGER, INSULATION MAY ALSO BE BLACK WITH GREEN TAPE/LABELS INSTALLED AT ALL ACCESS POINTS.

- B. IN A HIGHWAY LIGHTING SYSTEM, THE EQUIPMENT GROUNDING CONDUCTOR SHALL BE THE SAME WIRE SIZE AS THE DUCT CABLE OR DISTRIBUTION CABLE CIRCUIT CONDUCTORS, WITH THE MINIMUM CONDUCTOR SIZE OF 4 AWG. BONDING JUMPERS WILL BE MINIMUM SIZE 4 AWG.

4. GROUND ROD.

- A. A 3/4-INCH SCHEDULE 40 PVC CONDUIT WILL BE USED IN FOUNDATIONS AND CONCRETE WALLS FOR THE GROUNDING CONDUCTOR (GROUND WIRE) RACEWAY TO THE GROUND ROD. SHOULD METALLIC CONDUIT BE USED, BOTH ENDS OF THE CONDUIT SHALL BE BONDED TO THE GROUNDING CONDUCTOR.

- B. THE TYPICAL GROUNDING CONDUCTOR (GROUND WIRE) SHALL BE 4 AWG INSULATED, COPPER.

- 5. THE GREEN CONDUCTOR IN SIGNAL CABLES (CONDUCTOR #4) SHALL NOT BE USED TO SUPPLY POWER TO A SIGNAL INDICATION. IT WILL BE CONNECTED TO THE SIGNAL BODY AS AN EQUIPMENT GROUND IN ALUMINUM HEADS AND IT WILL BE UNUSED IN PLASTIC HEADS. UNUSED CONDUCTORS SHALL BE GROUNDED IN THE CABINET. TYPICAL USE OF CONDUCTORS IS AS FOLLOWS:

| COND. NO. | COLOR | VEHICLE SIGNAL | PEDESTRIAN SIGNAL |
|-----------|--------------------|------------------|-------------------|
| 1 | BLACK | GREEN BALL | #1 WALK |
| 2 | WHITE | AC NEUTRAL | AC NEUTRAL |
| 3 | RED | RED BALL | #1 DW/FDW |
| 4 | GREEN | EQUIPMENT GROUND | EQUIPMENT GROUND |
| 5 | ORANGE | YELLOW BALL | #2 DW/FDW |
| 6 | BLUE | GREEN ARROW | #2 WALK |
| 7 | WHITE/BLACK STRIPE | YELLOW ARROW | NOT USED |

6. POWER SERVICE AND DISCONNECT SWITCH.

- A. AT THE POWER SERVICE LOCATION, THE GROUNDING CONDUCTOR (GROUND WIRE) FROM THE DISCONNECT SWITCH NEUTRAL (AC-) BAR TO THE GROUND ROD SHALL BE A CONTINUOUS, UNSPLICED CONDUCTOR. IF SPLICED, IT SHALL BE AN EXOTHERMIC WELD BUTT SPLICE.

- B. THE SERVICE NEUTRAL (AC-) SHALL ONLY BE CONNECTED TO GROUND AT THE PRIMARY POWER SERVICE DISCONNECT SWITCH.

- I. NEMA CONTROLLER CABINETS: IF A POWER SERVICE DISCONNECT SWITCH IS LOCATED BEFORE THE CONTROLLER CABINET, THE NEUTRAL (AC-) AND THE GROUNDING BARS IN THE CONTROLLER CABINET SHALL NOT BE CONNECTED TOGETHER AS SHOWN IN NEMA TS-2, FIGURE 5-4.

GROUNDING AND BONDING (CONT)

- II. IF SECONDARY DISCONNECT SWITCHES ARE CONNECTED AFTER THE PRIMARY DISCONNECT SWITCH, THE NEUTRAL (AC-) SHALL ONLY BE GROUNDED AT THE PRIMARY SWITCH. EQUIPMENT GROUNDING CONDUCTORS SHALL BE BROUGHT TO THE PRIMARY SWITCH, BUT SHALL BE GROUNDED AT BOTH SECONDARY AND PRIMARY SWITCHES.

- 7. PAYMENT - ALL MATERIALS AND WORK REQUIRED TO COMPLETE THE EFFECTIVE GROUND FAULT CURRENT PATH SYSTEM ARE INCIDENTAL TO THE CONDUCTORS INSTALLED BY CONTRACT.

632 REMOVAL OF TRAFFIC SIGNAL INSTALLATION

TRAFFIC SIGNAL INSTALLATIONS, INCLUDING SIGNAL HEADS, CABLE, SIGNAL SUPPORTS, CABINET, CONTROLLER ETC., SHALL BE REMOVED IN ACCORDANCE WITH C&MS 632.26 AND AS INDICATED ON THE PLANS. POWER SERVICE SHALL BE REMOVE IN ACCORDANCE WITH C&MS 625.21.F.

REMOVED ITEMS LISTED BELOW SHALL BE DELIVERED TO THE CITY OF FRANKLIN FACILITY PROVIDED HERE.

SIGNAL HEADS
CABINET
CONTROLLER

REMOVED ITEMS SHALL BE DELIVERED TO THE CITY OF FRANKLIN FACILITY WHOSE ADDRESS IS LISTED BELOW:

CITY OF FRANKLIN SIGNAL SHOP
M-F, 9 AM - 2 PM
ATTN:
PHONE:

IN THE EVENT THE ITEMS LISTED HERE FOR SALVAGE ARE NOT WANTED BY THE LOCAL AGENCY, THE CONTRACTOR SHALL, WHEN DIRECTED BY THE ENGINEER IN WRITING, REMOVE AND DISPOSE OF THE ITEMS AT NO ADDITIONAL COST TO THE PROJECT.

SIGNAL INSPECTION

THE CONTRACTOR SHALL PROVIDE THE PROJECT ENGINEER, CITY TRAFFIC ENGINEER AND ORDC WITH 72-HOUR NOTICE OF THE FINAL SIGNAL WORK TO BE PERFORMED AT THE INTERSECTION SITE. THIS IS FOR THE PURPOSE OF TESTING THE TRAFFIC SIGNAL AND THE RAILROAD SIGNAL EQUIPMENT INTERFACE. A REPRESENTATIVE FROM ORDC SHALL BE ON SITE TO OVERSEE THE FINAL INSPECTION AND CONFIRM THAT THE TRAFFIC SIGNAL AND THE RAILROAD DEVICES ARE WORKING PER THE REQUIREMENTS SET FORTH IN THE TEM FOR RAILROAD PREEMPTION.

THIS INSPECTION WILL BE IN ADDITION TO THE FINAL SIGNAL INSPECTION. PAYMENT FOR THE SECOND INSPECTION SHALL BE INCLUDED IN PAYMENT WITH ITEM 819 RAILROAD PREEMPTION INTERFACE.

DESIGN AGENCY



CLIENT



DESIGNER

DLW

REVIEWER

SJS 06/07/24

PROJECT ID

115153

SHEET TOTAL

P.17 | 29

633 UNINTERRUPTIBLE POWER SUPPLY (UPS), 1000 WATT, AS PER PLAN

IN ADDITION TO THE REQUIREMENTS OF C&MS 633 AND 733, POLE ATTACHMENT HARDWARE WILL BE INCLUDED FOR POLE-MOUNTED CABINETS, AND A CABINET RISER (8-INCH MINIMUM) AND ANCHOR BOLTS WILL BE PROVIDED FOR BASE-MOUNTED CABINETS. BEFORE PERFORMING THE WORK, THE CONTRACTOR, THE CITY TRAFFIC ENGINEER AND THE PROJECT ENGINEER WILL PERFORM A SITE INSPECTION TO ESTABLISH THE LOCATION OF THE UPS CABINET AND FOUNDATION.

THE UPS CABINET SHALL INCLUDE A GENERATOR POWER PANEL WITH A HEAVY-DUTY POWER RELAY VERSUS THE LINE VOLTAGE GENERATOR SWITCH. THE GENERATOR INLET SHALL BE A RECESSED PANEL WITH A DOOR THAT IS FLUSH WITH THE EXTERNAL SIDE OF THE UPS CABINET. IT SHALL INCLUDE A RECESSED PLUG, AUTOMATIC TRANSFER SWITCH AND A DOOR THAT SECURELY CLOSSES OVER THE POWER CORD.

THE CABINET SHALL HAVE A DOOR STOP MECHANISM AND THERMOSTATICALLY CONTROLLED FAN. ADDITIONALLY, THE CABINET SHALL BE BUILT WITH ALL BATTERIES ALWAYS BELOW THE INVERTER TO AVOID POTENTIAL FUTURE BATTERY LEAKAGE ISSUES. THE CABINET SHALL INCLUDE A BATTERY BALANCING DEVICE THAT REGULATES THE BATTERIES AND OPTIMIZES PERFORMANCE.

AFTER FOUR (4) HOURS OF BATTERY RUNTIME, THE SYSTEM SHALL BE PROGRAMMED TO SWITCH THE INTERSECTION FROM FULL OPERATION TO CONTROLLER AUTOMATIC FLASH OPERATION THROUGH THE MONITOR. THE CONTROLLER SHALL BE PROGRAMMED SO THAT FLASH OPERATION SHALL BEGIN ONCE THE INTERSECTION RUNS MINOR STREET GREEN (TYP. PH. 4 & 8), ALL-RED CLEARANCE, AND THEN FLASH OPERATION.

THE UPS OUTPUT NOTIFICATIONS FOR ON BATTERY, BATTERY 2-HOUR TIMER, AND LOW BATTERY SHALL BE WIRED INTO THE TRAFFIC SIGNAL CABINET BACK PANEL OR THROUGH THE CONTROLLER WITH A C11 TO PROVIDE SPECIAL STATUS ALARMS FOR EACH OUTPUT INTO THE SIGNAL CONTROLLER.

THIS ITEM SHALL INCLUDE A RED LED STATUS INDICATOR LAMP TO ALLOW MAINTENANCE PERSONNEL AND LAW ENFORCEMENT TO QUICKLY ASSESS WHETHER A TRAFFIC SIGNAL CABINET IS BEING POWERED BY A UPS. THE LED HOUSING SHALL BE NEMA 4X, IP65 OR IP66, RATED FOR OUTDOOR USE AND BE TAMPER/SHATTER RESISTANT. IT SHALL BE A DOMED ENCLOSURE CONTAINING A RED LENS WITH LED THAT IS VISIBLE FROM 100 FOOT MINIMUM. THE ENCLOSURE AND LED MODULE SHOULD BE PLACED ON THE SIDE OF THE UPS CABINET FACING TOWARDS THE MAINLINE ROADWAY AND SEALED FROM WATER INTRUSION. IT SHOULD BE WIRED USING MINIMUM 20GA STRANDED, INSULATED HOOKUP WIRE TO THE STATUS RELAY OUTPUTS OF THE UPS. THE WIRES SHALL BE TERMINATED BY LUGS AT THE DISPLAY END AND PERMANENTLY LABELED "BACKUP POWER STATUS DISPLAY," WITH WIRE POLARITY INDICATED. THE RED LED SHALL ONLY ILLUMINATE TO INDICATE THE CABINET IS OPERATING UNDER UPS BACKUP POWER (THE "BACKUP" OPERATING CONDITION). THIS ITEM INCLUDES PROGRAMMING THE UPS STATUS RELAY OUTPUTS TO PRODUCE THE LAMP STATUS DISPLAYS. THESE STATUS DISPLAYS WILL BE SOLID 100% DUTY CYCLE (NOT FLASHING) DISPLAYS. THE OPERATING VOLTAGE OF THE LED LAMP SHALL BE 120V AC UNLESS OTHERWISE INDICATED.

828 LED BLANKOUT SIGN (NO TURN - TRAIN)

THE CONTRACTOR SHALL PROVIDE AND INSTALL A SOLID FILLED RED SYMBOL, SOLID FILLED WHITE ARROW NO RIGHT TURN SYMBOL SIGN ON THE TRAFFIC SIGNAL MAST ARM AT THE LOCATIONS INDICATED ON THE PLANS. THE SYMBOL SIGN SHALL BE A WEATHER TIGHT NEMA ENCLOSURE. THE FOLLOWING SPECIFICATIONS SHALL APPLY:

VOLTAGE: 120V
ILLUMINATION: LED
SYMBOL HEIGHT: 20.0"
CABINET SIZE: 30"H x 24"W x 5.5" D
FINISH: BLACK
WARRANTY: 5 YEARS



R3-1-24

THE SIGNS SHALL BE WIRED TO ACTIVATE DURING THE RAILROAD PREEMPTION PHASES AND REMAIN ON FOR THE ENTIRE RAILROAD PREEMPTION CYCLE.

THE MAST ARM MOUNTING BRACKET SHALL BE SUPPLIED BY THE SIGN MANUFACTURER AND INSTALLED BY THE CONTRACTOR. THE SIGN SHALL BE ACTIVATED (ON) WHEN THE CONTROLLER RECEIVES A RAILROAD PREEMPTION CALL. THE REMAINING TIME THE SIGN SHALL BE BLANK OR OFF.

PAYMENT FOR THE ABOVE ITEM SHALL BE PAID AT THE UNIT PRICE BID PER EACH FOR ITEM 828, LED BLANKOUT SIGN, LED BLANKOUT SIGN COMPLETE. PRICE SHALL INCLUDE ALL LABOR, EQUIPMENT, MATERIALS, MOUNTING HARDWARE FOR RIGID MOUNTING, POWER CABLE AND ALL INCIDENTALS TO COMPLETE THE WORK.

632 PEDESTRIAN SIGNAL HEAD (LED), (COUNTDOWN), TYPE D2, AS PER PLAN

IN ADDITION TO THE REQUIREMENTS OF C&MS 632 AND 732 THE FOLLOWING SHALL APPLY:

1. SIGNAL HEADS AND VISORS SHALL BE CONSTRUCTED OF BLACK POLYCARBONATE PLASTIC AND MEET ITC SPECIFICATIONS.
2. PROPER EXTERIOR COLORS SHALL BE OBTAINED BY USE OF COLORED PLASTIC MATERIAL RATHER THAN PAINTING.
3. PIPE, SPACERS AND FITTINGS CONSTRUCTED OF POLYCARBONATE PLASTIC MAY BE USED IN LIEU OF GALVANIZED STEEL OR ALUMINUM.
4. THE PEDESTRIAN SIGNAL HEAD SHALL BE OF THE LED COUNTDOWN TYPE.
5. NEW ATTACHMENT HARDWARE AND FITTINGS SHALL BE USED.
6. THE LIGHT EMITTING DIODE (LED) MODULES SHALL MEET THE REQUIREMENTS OF C&MS 732.04. THE CONTRACTOR SHALL PROVIDE THE CITY OF FRANKLIN ENGINEER, IN WRITING, WITH THE LED MANUFACTURER NAME SERIAL NUMBER, PART NUMBER, DESCRIPTION OF LAMP, AND DATE OF MANUFACTURE FOR ALL LED UNITS THAT ARE TO BE USED IN THE SIGNAL HEAD PRIOR TO INSTALLATION, FOR ACCEPTANCE AND WARRANTY PURPOSES.

PAYMENT FOR ITEM 632 PEDESTRIAN SIGNAL HEAD (LED), (COUNTDOWN), TYPE D2, AS PER PLAN SHALL BE MADE FOR THE NUMBER OF COMPLETE SIGNAL HEAD FURNISHED AND INSTALLED, INCLUDING ALL LABOR, EQUIPMENT, MATERIALS AND NEW ATTACHMENT HARDWARE.

632 SIGNAL SUPPORT FOUNDATION

PRIOR TO ORDERING THE SIGNAL SUPPORTS, THE CONTRACTOR SHALL CONTACT OUPS TO HAVE ALL THE UTILITIES LOCATED IN THE FIELD. THEN THE CONTRACTOR SHALL MEET THE PROJECT ENGINEER TO LOCATE THE PROPOSED SUPPORT LOCATIONS TO INSURE THERE ARE NO CONFLICTS WITH UTILITIES. IF THERE ARE ISSUES, THE PROJECT ENGINEER SHALL PROVIDE GUIDANCE AS TO THE RELOCATION OF THE SUPPORTS.

DUE TO THE FURTHER POSSIBILITY OF CONFLICT WITH EXISTING OR PROPOSED UNDERGROUND OBSTRUCTIONS (INCLUDING THE POSSIBILITY OF UNRECORDED OBSTRUCTIONS) WHICH COULD AFFECT THE LOCATION OF THE FOUNDATION FOR THIS ITEM, AND CONSEQUENTLY, THE DESIGN OF THE SUPPORT AND/OR ARMS, THE CONTRACTOR SHALL NOT PLACE FINAL ORDERS FOR THE ITEM UNTIL THE FOUNDATIONS HAVE BEEN INSTALLED, AT FINAL GRADE, AND THE CONTRACTOR HAS RECEIVED, FROM ENGINEER, WRITTEN NOTICE TO PROCEED WITH THE ORDERS FOR THE ITEM.

IF ANY FOUNDATION LOCATIONS MUST BE ADJUSTED, THE CONTRACTOR SHALL NOTIFY THE ENGINEER AND MAINTAINING AGENCY, WHO WILL DETERMINE THE REVISED LOCATION AND IF NEEDED, THE SUPPORT DESIGN. THE CONTRACTOR WILL NOT BE RESPONSIBLE FOR DETERMINING THE REVISED DESIGN. THE ENGINEER WILL INFORM THE CONTRACTOR OF ANY CHANGES NECESSARY AND AUTHORIZE THE CONTRACTOR TO ORDER THE SUPPORT.

THE CONTRACTOR SHALL, WHEN DEVELOPING THE PROGRESS SCHEDULE, AND THOSE OF SUBCONTRACTORS, ENSURE THAT THE FOUNDATIONS ARE INSTALLED AT THE EARLIEST TIME AS IS FEASIBLE AND PRACTICAL, AND SHALL INCLUDE SUFFICIENT TIME IN THE PROGRESS SCHEDULE FOR ORDERING, MANUFACTURING, DELIVERY, AND INSTALLATION OF THE SUPPORT ITEMS AFTER THE FOUNDATIONS ARE IN PLACE.

NO PAYMENTS FOR DELIVERED MATERIALS FOR THE FOUNDATION OR SUPPORT ITEMS SHALL BE MADE UNTIL THE FOUNDATIONS ARE IN PLACE, AND IF CHANGES IN THE DESIGN OF THIS ITEM ARE REQUIRED, NO PAYMENT SHALL BE MADE FOR THE ITEMS MANUFACTURED TO THE ORIGINAL DESIGN.

PAYMENT WILL BE AT THE CONTRACT UNIT PRICE AND WILL BE FULL COMPENSATION FOR ALL LABOR, MATERIALS, TOOLS, EQUIPMENT AND OTHER INCIDENTALS NECESSARY FOR EACH SUPPORT FURNISHED, IN PLACE, COMPLETE AND ACCEPTED.

819 RAILROAD PREEMPTION INTERFACE

INSTALL AN INDICATOR PANEL PER CMS 819.09 ON PROPOSED SIGNAL POLE SP-1 AT THE INTERSECTION OF S 6TH STREET AND S RIVER STREET. THE INDICATOR PANEL SHALL BE FACING THE TRAFFIC SIGNAL CABINET. MOUNT THE INDICATOR PANEL NO LESS THAN TEN FEET ABOVE THE ROADWAY LEVEL. ALSO, LOCATE THE INDICATORS SO AS TO PROVIDE MINIMAL VISIBILITY TO ROADWAY USERS AT OR APPROACHING THE INTERSECTION.

THE CONTRACTOR SHALL SCHEDULE A FINAL FIELD TEST, AFTER THE 10-DAY SIGNAL BURN TEST, WITH THE RAILROAD OWNER, OHIO RAIL DEVELOPMENT COMMISSION REPRESENTATIVE AND THE SIGNAL CONTRACTOR. THE FINAL FIELD TEST SHALL INCLUDE CHECKING THAT THE SIGNAL IS CONNECTED TO THE RAILROAD CONTROLLER AND OPERATES PER THE PLANS DURING A PREEMPTION CALL.

PAYMENT- ALL MATERIALS AND COST FOR THIS ITEM SHALL BE COMPLETE AND INCLUDED IN ITEM 819 - RAILROAD PREEMPTION INTERFACE, 1 EACH.

UNDERDRAINS FOR PULL BOXES

REFERENCE TRAFFIC SCD HL-30.11 FOR DETAILS ABOUT DRAINING PULL BOXES. UNDERDRAINS FOR PULL BOXES SHALL BE USED AS DIRECTED BY THE ENGINEER AND SHALL BE PROVIDED WHERE THE LENGTH REQUIRED FOR A SATISFACTORY OUTLET DOES NOT EXCEED 20 FEET. THE FOLLOWING ESTIMATED QUANTITY IS CARRIED TO THE GENERAL SUMMARY FOR THIS PURPOSE:

ITEM 611 4" CONDUIT, TYPE E 100 FT.

631, INTERNALLY ILLUMINATED FIXED MESSAGE SIGN, AS PER PLAN

THIS ITEM SHALL CONSIST OF SUPPLYING AND INSTALLING INTERNALLY ILLUMINATED FIXED MESSAGE STREET NAME SIGNS AND THE R3-1-30 SIGN, WITH EDGE LIT LIGHT EMITTING DIODES (LED) OR LIGHT EMITTING CAPACITORS (LEC). THE SIGNS SHALL CONFORM TO ODOT CMS 631 AND 731.05. THE SIGN LEGEND SHALL CONFORM THE OHIO MANUAL OF UNIFORM TRAFFIC CONTROL DEVICES (O.M.U.T.C.D.).

STREET NAME SIGNS AND THE R3-1-30 SIGN SHALL HAVE ONE (1) FACE. THE LEGEND BACKGROUND SHALL BE GREEN WITH WHITE LETTERS FOR THE STREET NAME SIGNS. THE R3-1-30 SIGN SHALL BE WHITE WITH RED AND BLACK SYMBOLS. THE SIGN HOUSING ENCLOSURE AND ALL MOUNTING HARDWARE SHALL BE BLACK IN COLOR. SIGN HANGER ASSEMBLIES (SUPPLIED AS PART OF A SEPARATE ITEM) SHALL BE USED TO RIGIDLY MOUNT THE ILLUMINATED STREET NAME SIGN ON THE MAST ARM. THE SIZE OF THE VIEWABLE SIGN LEGEND SHALL BE PER THE DETAILS IN THE PLANS. THIS ITEM SHALL INCLUDE SUPPLYING AND INSTALLING A WATERPROOF SPLICE KIT APPROVED BY THE CITY IF PIGTAILS ARE SUPPLIED WITH THE SIGN. THE CONTRACTOR SHALL SUPPLY SHOP DRAWINGS TO THE CITY FOR REVIEW PRIOR TO FABRICATION.

THE COST FOR THIS ITEM SHALL INCLUDE ALL LABOR, MATERIAL AND EQUIPMENT FOR A COMPLETE AND OPERATIONAL INTERNALLY ILLUMINATED SIGN, TESTED AND ACCEPTED.

630, SIGN HANGER ASSEMBLY, MAST ARM, AS PER PLAN

IN ADDITION TO THE REQUIREMENTS OF CMS 630 (SIGN HANGER ASSEMBLY, MAST ARM) THE CONTRACTOR SHALL SUPPLY A RIGID MOUNT TYPE SIGN HANGER ASSEMBLY. THE SIGN HANGER ASSEMBLY SHALL CONTAIN A BRACE THAT RUNS ALONG THE COMPLETE VERTICAL HEIGHT OF THE SIGNS. THE SIGN HANGER ASSEMBLY AND ALL MISCELLANEOUS HARDWARE SHALL BE BLACK IN COLOR.

PAYMENT FOR THIS ITEM SHALL BE AT THE CONTRACT UNIT BID PRICE PER EACH AND SHALL INCLUDE ALL LABOR, EQUIPMENT AND MATERIAL, INCLUDING HARDWARE, INSTALLED COMPLETE.



809 STOP-LINE RADAR DETECTION, AS PER PLAN

THIS ITEM OF WORK SHALL CONSIST OF FURNISHING AND INSTALLING A WAVETRONIX SMARTSENSOR MATRIX DETECTION UNIT. THE DETECTION UNIT SHALL INCLUDE THE FOLLOWING:

1. POWER SHALL BE PROVIDED FROM THE TRAFFIC CABINET.
2. ALL REQUIRED INPUTS CARDS SHALL BE INCLUDED IN THE TRAFFIC CABINET AND SHALL BE COMPATIBLE WITH CALTRANS, NEMA TS1 AND NEMA TS2 DETECTOR RACKS. THE CARDS SHALL PROVIDE TRUE PRESENCE DETECTOR CALLS OR CONTACT CLOSURE TO THE TRAFFIC CONTROLLER.
3. THE UNIT SHALL BE MOUNTED DIRECTLY TO A POLE OR MAST ARM, AS RECOMMENDED BY THE MANUFACTURER. CABLE(S) SHALL BE PROVIDED AS REQUIRED AND RECOMMENDED BY THE MANUFACTURER. SURGE PROTECTION DEVICES, AS RECOMMENDED BY THE MANUFACTURER SHALL BE INCLUDED BOTH AT THE POLE WHERE THE UNIT IS LOCATED TO PROTECT THE UNIT AND IN THE TRAFFIC CABINET TO PROTECT THE CABINET ELECTRONICS.
4. THE MANUFACTURER'S REPRESENTATIVE SHALL BE ON SITE DURING INSTALLATION AND TESTING AND SHALL PROVIDE ONSITE TRAINING ON THE SETUP, OPERATION AND MAINTENANCE OF THE UNIT. A SERIAL TO ETHERNET COMMUNICATIONS MODULE AND ETHERNET CABLE (MINIMUM 7 FEET).
5. THE POWER SUPPLY AND COMMUNICATION MODULES SHALL BE SECURED TO A SINGLE PANEL THAT CAN BE MOUNTED INTERIOR TO THE TRAFFIC CABINET. THE PANEL SHALL INCLUDE MODULAR-PLUG STYLE CONNECTIONS FOR UP TO FOUR (4) SENSOR CABLES. ADDITIONAL SENSORS MAY BE HARD-WIRED TO THE COMMUNICATION MODULES, AS NECESSARY.
6. THE CONTRACTOR SHALL INSTALL THE RADAR DETECTION PRIOR TO MILLING/DISABLING EXISTING LOOPS.
7. THE INSTALLATION SHALL INCLUDE ALL CONTROLLER PROGRAMMING FOR COMPLETE INSTALLATION, WHICH INCLUDES MODIFICATIONS FOR REMOVAL OF EXISTING DETECTION.

PAYMENT FOR ITEM 809 STOP-LINE RADAR DETECTION, AS PER PLAN SHALL BE MADE AT THE CONTRACT UNIT PRICE FOR EACH UNIT, COMPLETE AND IN PLACE INCLUDING ALL REQUIRED CABINET HARDWARE, MOUNTING BRACKETS, CABLES, CONDUIT AND CONNECTIONS TESTED AND ACCEPTED.

809 ATC CONTROLLER, AS PER PLAN

THE CONTROLLER UNIT SHALL BE FURNISHED AND INSTALLED PER SS 809 AND BE LISTED ON THE TRAFFIC AUTHORIZED PRODUCTS (TAP) LIST.

THE CONTROLLER SHALL BE AN ECONOLITE COBALT AND COMPATIBLE WITH THE CABINET TYPE BEING INSTALLED.

WORK INSPECTION

THE CONTRACTOR SHALL PROVIDE THE PROJECT ENGINEER, ORDC AND THE CITY OF FRANKLIN ENGINEER WITH 72-HOUR NOTICE OF ANY SIGNAL WORK TO BE PERFORMED AT THE INTERSECTION SITES SO THAT INSPECTION SERVICES CAN BE SUPPLIED.

633 CABINET, TYPE 332, AS PER PLAN

THE CABINET SHALL BE FURNISHED AND INSTALLED ACCORDING TO CMS 633 AND 733, AND BE LISTED ON THE TRAFFIC AUTHORIZED PRODUCTS LIST (TAP).

THE CABINET SHALL BE FURNISHED WITH AN EDI MONITOR AS ALLOWED ON THE TAP/APPROVED PRODUCTS LIST.

THE CONTRACTOR SHALL NOT REASSIGN THE CABINET DETECTOR INPUTS IN ORDER TO REDUCE THE NUMBER OF 2-CHANNEL DETECTOR UNITS SUPPLIED AND SHALL USE THE STANDARD CALTRANS INPUT FILE DESIGNATIONS FOLLOWING PLAN INSERT SHEET 203324.

PAYMENT FOR ITEM 633 CABINET, TYPE 332, AS PER PLAN WILL BE AT THE CONTRACT BID PRICE PER EACH COMPLETE AND IN PLACE INCLUDING ALL CONNECTIONS TESTED AND ACCEPTED.

MODEL 332 CABINET DETAIL (TYP.)

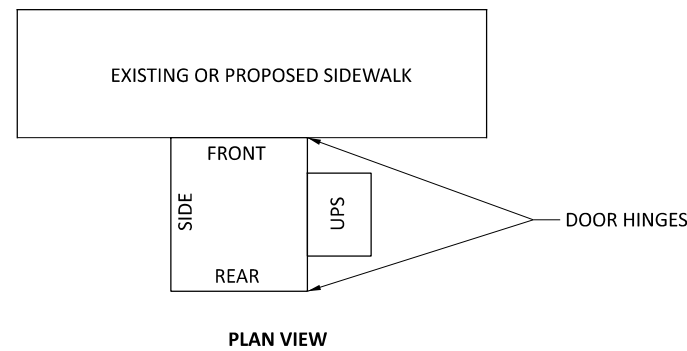

633 CABINET FOUNDATION, AS PER PLAN

THE CABINET FOUNDATION SHALL BE ORIENTED WITH RESPECT TO THE INTERSECTION IN A MANNER THAT WILL PROVIDE MAINTENANCE PERSONNEL WITH A VIEW OF THE INTERSECTION WHILE WORKING ON THE CONTROLLER.

UPS FOUNDATION DETAIL

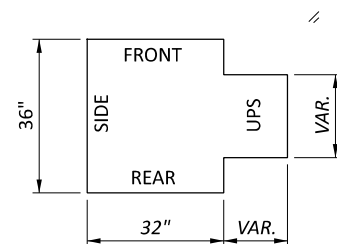
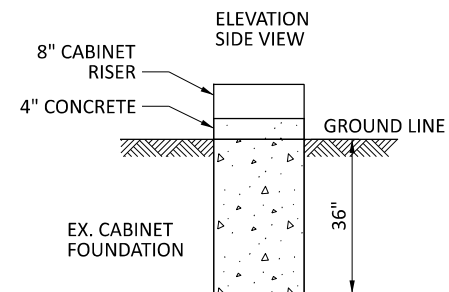

NOTES:

- 1) THE SIZE OF THE UPS FOUNDATION MAY VARY BASED ON THE CABINET SIZE PROVIDED.
- 2) UPS FOUNDATION ELEVATION SHOULD MATCH CABINET FOUNDATION ELEVATION.
- 3) THE UPS CABINET SHALL BE MOUNTED FLUSH UP AGAINST THE SIGNAL CABINET AND SEALED.
- 4) CONDUIT AND WIRING FROM THE SIGNAL CABINET TO THE UPS SHALL BE INSTALLED THROUGH THE CABINET RISER.

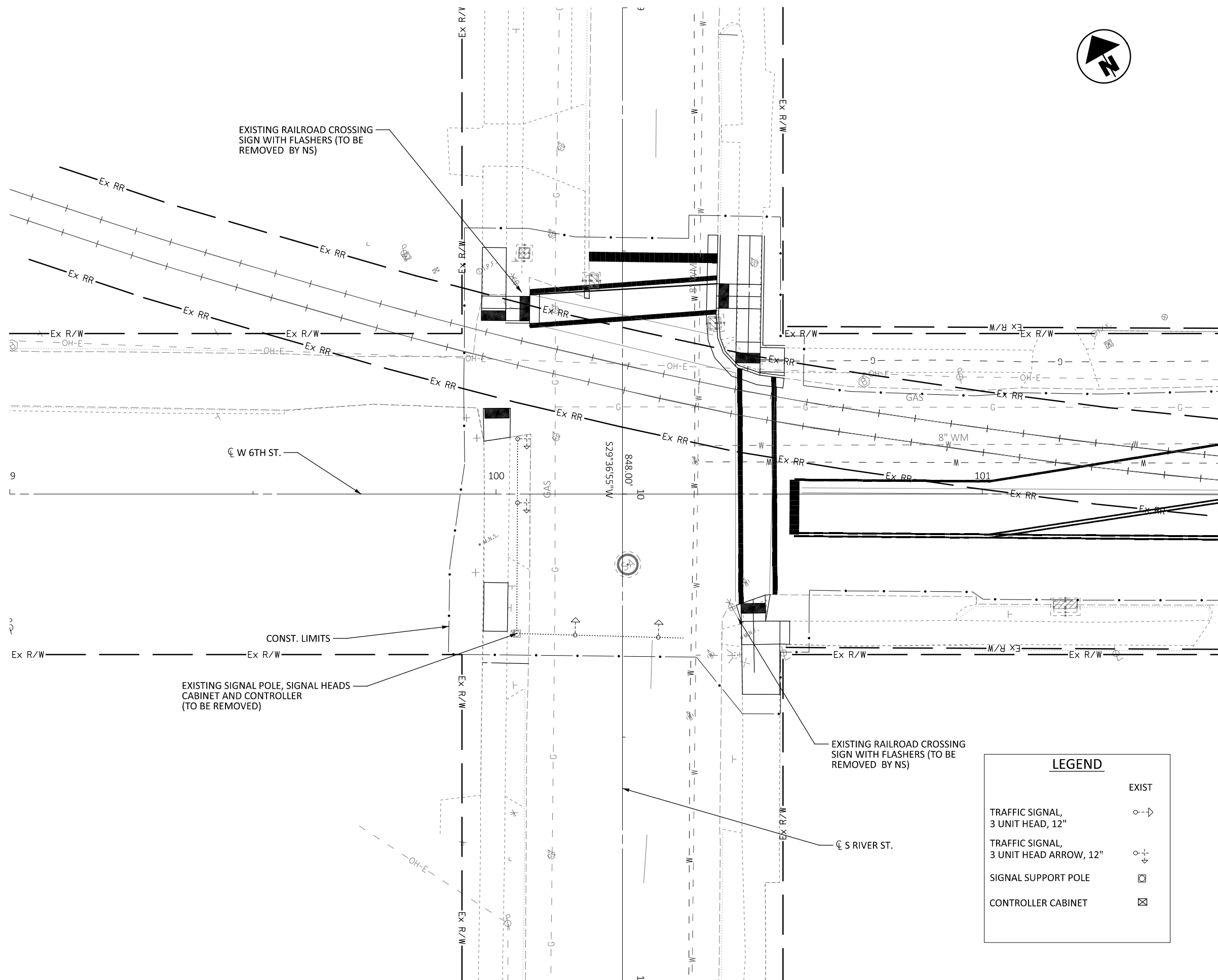

**SOUTH RIVER ST. & WEST 6TH ST.
 SIGNAL REMOVAL PLAN**

| LEGEND | |
|---|-----|
| EXIST | ○ → |
| TRAFFIC SIGNAL, 3 UNIT HEAD, 12" | ○ ⊕ |
| TRAFFIC SIGNAL, 3 UNIT HEAD ARROW, 12" | ○ ⊕ |
| SIGNAL SUPPORT POLE | ⊠ |
| CONTROLLER CABINET | ⊠ |

DESIGN AGENCY
Mead & Hunt
 CLIENT



DESIGNER
DLW
 REVIEWER
SJS 06/07/24
 PROJECT ID
115153
 SHEET TOTAL
 P.21 29

SIGNAL HEADS

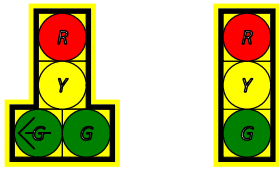

8A 6A, 6B
8B
ALL SIGNAL HEADS SHALL BE 12" LED WITH BACKPLATES.

PEDESTRIAN SIGNS

S1 (2-SIGNS)
THESE SIGNS ARE INCLUDED IN PAYMENT WITH THE PED PUSHBUTTON AND ARE LOCATED ABOVE THE PUSHBUTTON

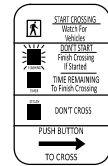

R10-3E-9
1-LEFT ARROWS
1-RIGHT ARROWS

PEDESTRIAN SIGNAL HEADS



PH2A, PH2B
PH8A, PH8B

LED INTERNALLY ILLUMINATED SIGNS

SIGNS TO BE MOUNTED ON SIGNAL MAST ARM SP-2 AND ARE PAID UNDER THE TRAFFIC CONTROL QUANTITIES



S2
D3-1, 78"X18" (SIGN FACE),
1-WAY LED INTERNALLY ILLUMINATED,
8" INCH "STANDARD HIGHWAY
SERIES D" LETTERS



S3
D3-1, 72"X18" (SIGN FACE),
1-WAY LED INTERNALLY ILLUMINATED,
8" INCH "STANDARD HIGHWAY
SERIES D" LETTERS



S4
R3-1-30, 30"X30" (SIGN FACE),
1-WAY LED INTERNALLY ILLUMINATED,

SIGNAL POLE & PEDESTRIAN POLE DETAILS

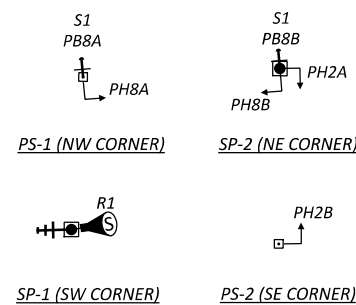

| PULL BOX # | STATION | SIDE | OFFSET | SIZE (IN.) |
|------------|---------|-------|--------|------------|
| PB-1 | 100+03 | RIGHT | 25' | 24 |
| PB-2 | 99+96 | LEFT | 45' | 24 |
| PB-3 | 100+56 | LEFT | 36' | 18 |
| PB-4 | 100+50 | RIGHT | 27' | 18 |

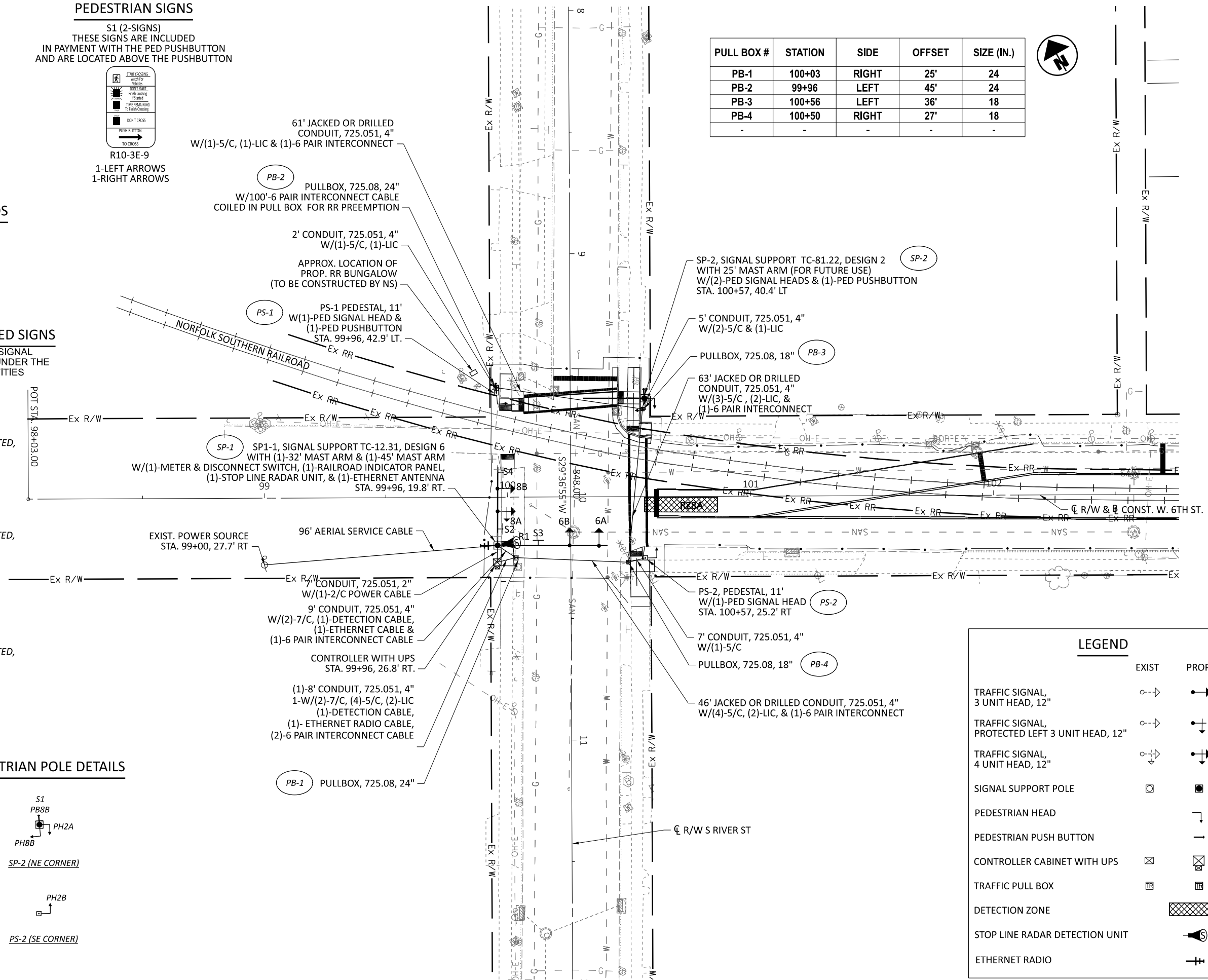
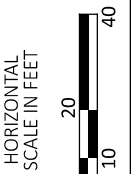

LEGEND

| | EXIST | PROP |
|---|-------|------|
| TRAFFIC SIGNAL, 3 UNIT HEAD, 12" | | |
| TRAFFIC SIGNAL, PROTECTED LEFT 3 UNIT HEAD, 12" | | |
| TRAFFIC SIGNAL, 4 UNIT HEAD, 12" | | |
| SIGNAL SUPPORT POLE | | |
| PEDESTRIAN HEAD | | |
| PEDESTRIAN PUSH BUTTON | | |
| CONTROLLER CABINET WITH UPS | | |
| TRAFFIC PULL BOX | | |
| DETECTION ZONE | | |
| STOP LINE RADAR DETECTION UNIT | | |
| ETHERNET RADIO | | |

SOUTH RIVER ST & WEST 6TH ST
TRAFFIC SIGNAL PLAN

SIGNAL TIMING CHART

TO BE COMPLETED ONCE EXISTING TIMING IS PROVIDED BY CITY OF FRANKLIN

| INTERSECTION: WAR-S RIVER & S MAIN NS MAINTAINING AGENCY: CITY OF FRANKLIN | | | | | | | | | |
|---|---------------------|-------------------------|---|--------------|---|---|----|---|-------|
| START UP | | DUAL ENTRY: YES | | PHASES: 6, 8 | | | | | |
| START IN: ALL RED | | REST IN RED: RING 1 | | RING 2 | | - | | | |
| TIME FOR FLASH OR ALL RED: 8 sec | | OVERLAP | | A | B | C | D | | |
| FIRST PHASE(S): 6 | | PHASES | | - | - | - | - | | |
| COLOR DISPLAYED: GREEN | | | | | | | | | |
| INTERVAL OR FEATURE | | CONTROLLER MOVEMENT NO. | | | | | | | |
| INTERSECTION MOVEMENT (PHASE) | | 1 | 2 | 3 | 4 | 5 | 6 | 7 | 8 |
| DIRECTION | | - | - | - | - | - | SB | - | WB LT |
| MINIMUM GREEN (INITIAL) (SEC.) | | | | | | | | | |
| ADDED INITIAL *(SEC./ACTUATION) | | | | | | | | | |
| MAXIMUM INITIAL (SEC.) | | | | | | | | | |
| PASSAGE TIME (PRESET GAP) (SEC.) | | | | | | | | | |
| TIME BEFORE REDUCTION *(SEC.) | | | | | | | | | |
| MINIMUM GAP *(SEC.) | | | | | | | | | |
| TIME TO REDUCE *(SEC.) | | | | | | | | | |
| MAXIMUM GREEN I (SEC.) | | | | | | | | | |
| MAXIMUM GREEN II (SEC.) | | | | | | | | | |
| YELLOW CHANGE (SEC.) | | | | | | | | | |
| ALL RED CLEARANCE (SEC.) | | | | | | | | | |
| WALK (SEC.) | | | | | | | | | |
| PEDESTRIAN CLEARANCE (SEC.) | | | | | | | | | |
| RECALL | MAXIMUM (ON/OFF) | | | | | | | | |
| | MINIMUM (ON/OFF) | | | | | | | | |
| | PEDESTRIAN (ON/OFF) | | | | | | | | |
| MEMORY (ON/OFF) | | | | | | | | | |

*VOLUME DENSITY CONTROLS

NOTES:
1. COUNTDOWN PEDESTRIAN SIGNAL HEADS SHALL GO TO ZERO ON YELLOW PER O MUTCD FIGURE 4E-2.

RADAR DETECTION CHART

| DETECTION ZONE | RADAR NO. | MOVEMENT | PULSE OR PRESENCE | ASSOCIATED PHASE | DELAY PROGRAMMED IN CONTROLLER (SEC.) | EXTENSION PROGRAMMED IN CONTROLLER (SEC.) | DELAY INHIBITED PHASE | PURPOSE | DETECTION ZONE LENGTH (FT) |
|----------------|-----------|----------|-------------------|------------------|---------------------------------------|---|-----------------------|---------------------|----------------------------|
| RZ8A | R1 | WB | PRESENCE | 8 | | | | CALL/EXTEND PHASE 8 | 30' |
| | | | | | | | | | |
| | | | | | | | | | |
| | | | | | | | | | |

PHASING DIAGRAM

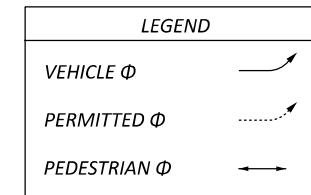
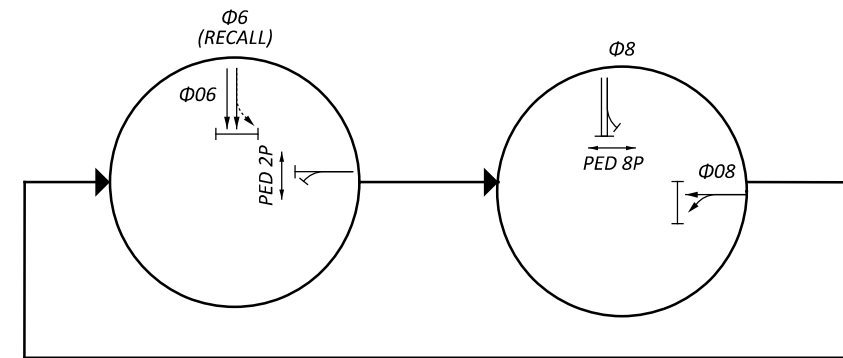

PREEMPTION PHASING DIAGRAM

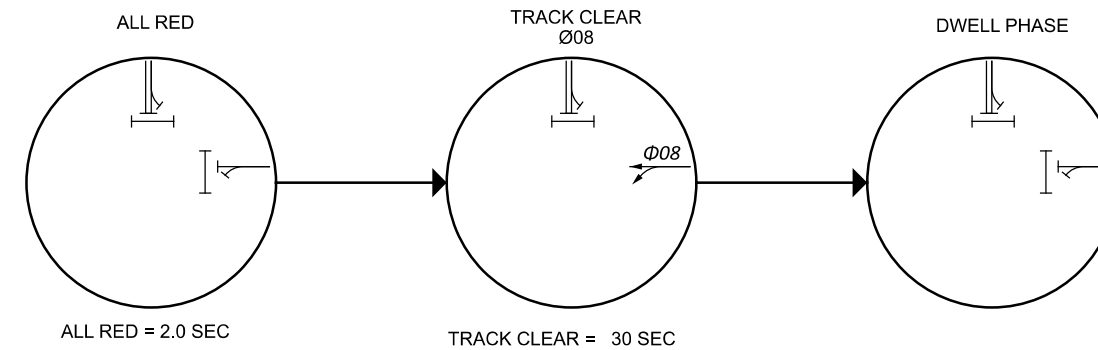

PEDESTRIAN PHASES OPERATING DURING THE PREEMPTION CALL SHALL BE TERMINATED.

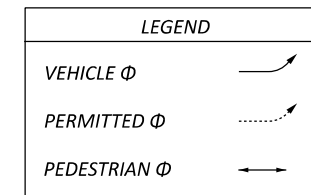

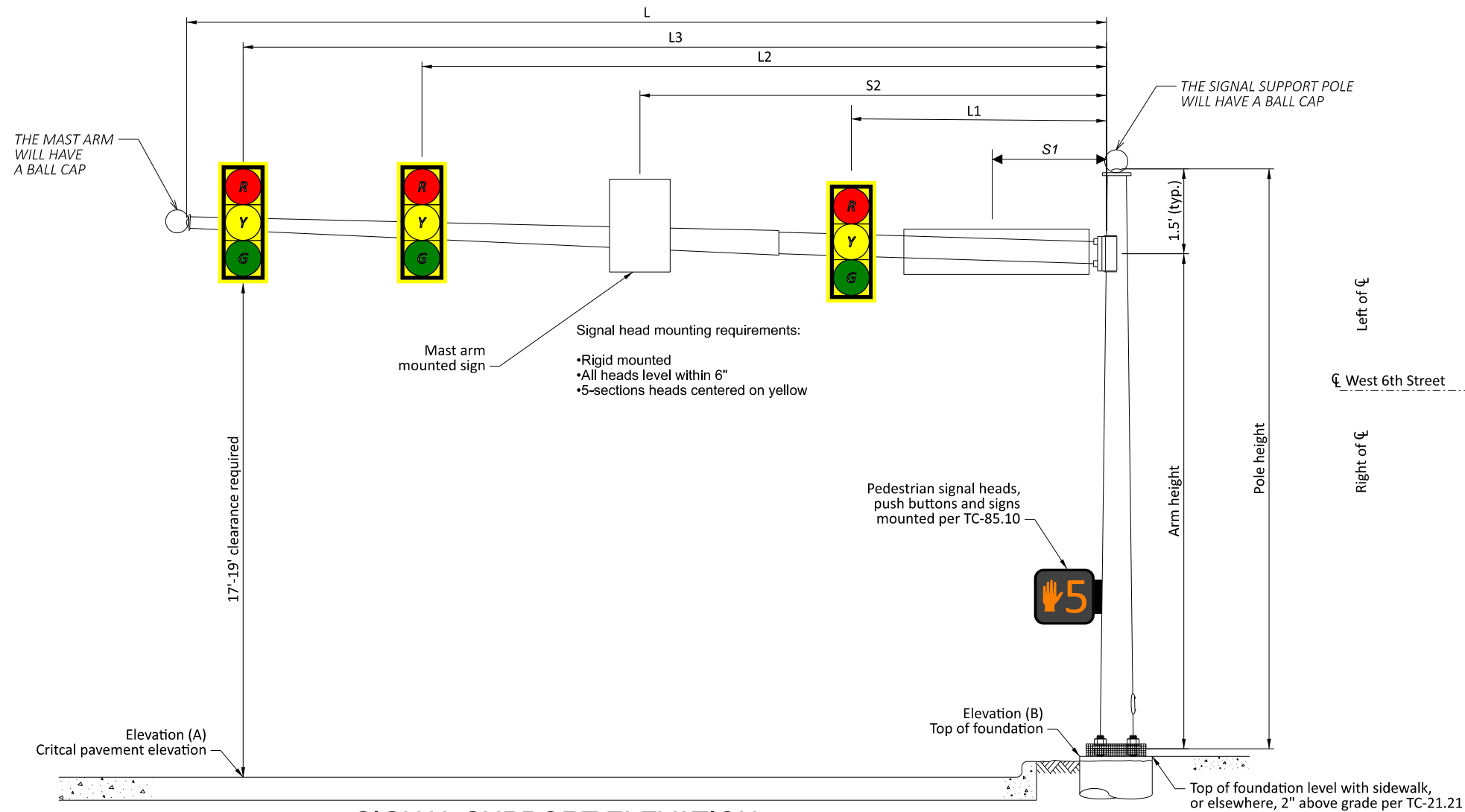

SIGNAL SUPPORT ELEVATION

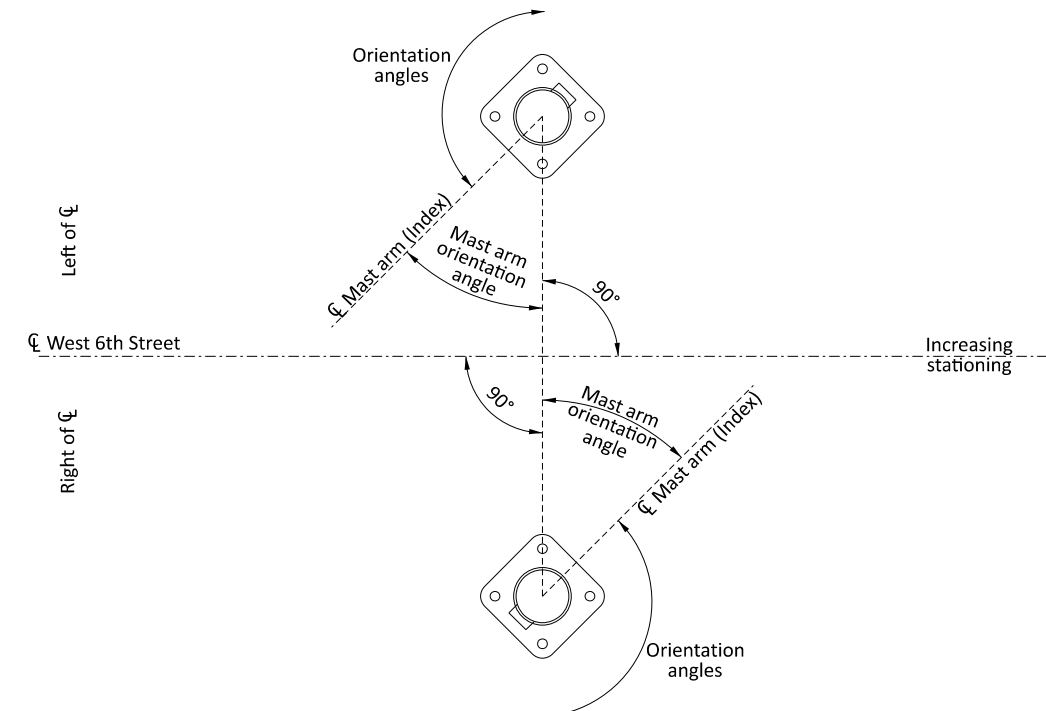

POLE ORIENTATION

MAST ARM TABLE

| SUPPORT NO. | STATION | OFFSET | ELEVATION | | SIGNAL SUPPORT DETAILS | | | | | | | | ORIENTATION ANGLES FROM MAST ARM | | | | | | | | | | |
|-------------|---------|----------|-----------|--------|------------------------|------------|-------------|------------|----|----|----|----|----------------------------------|------------------|------------------|-------------------|-------------------|---------------|----------------------|----------|-----------------------------|--|--|
| | | | A | B | DESIGN TYPE | DESIGN NO. | POLE HEIGHT | ARM HEIGHT | L | L1 | L2 | S1 | S2 | MAST ARM A ANGLE | MAST ARM B ANGLE | PEDESTRIAN SIGNAL | PEDESTRIAN BUTTON | POWER SERVICE | STOP LINE RADAR UNIT | HANDHOLE | CABLE ENTRANCE 12" FROM TOP | | |
| | | | FT | FT | FT | FT | FT | FT | FT | FT | FT | FT | FT | DEG | DEG | DEG | DEG | DEG | DEG | DEG | DEG | | |
| SP-1 | 99+96 | 19.8' RT | | 680.62 | TC-12.31 | 6 | 23 | | | | | | | | | | | | | | | | |
| SP-1(ARM B) | | | 681.09 | | TC-81.22 | 12 | 20 | 45 | 30 | 42 | 15 | - | 90 | - | - | - | - | - | - | 180 | - | | |
| SP-1(ARM A) | | | 681.02 | | TC-81.22 | 2 | 21.5 | 32 | 14 | 23 | 7 | 28 | - | 0 | - | - | 268 | 81 | - | - | 268 | | |
| SP-2 | 100+57 | 40.4' LT | 681.30 | 681.18 | TC-81.22 | 2 | 22 | 20.5 | 25 | | | | | 90 | - | 179/265 | 85 | - | - | 180 | - | | |
| PS-1 | 99+96 | 42.9' LT | - | - | - | - | 11 | - | - | - | - | - | - | - | - | 355 | 185 | - | - | 90 | - | | |
| PS-2 | 100+57 | 25.2' RT | - | - | - | - | 11 | - | - | - | - | - | - | - | - | 90 | - | - | - | 180 | - | | |

WIRING DIAGRAM

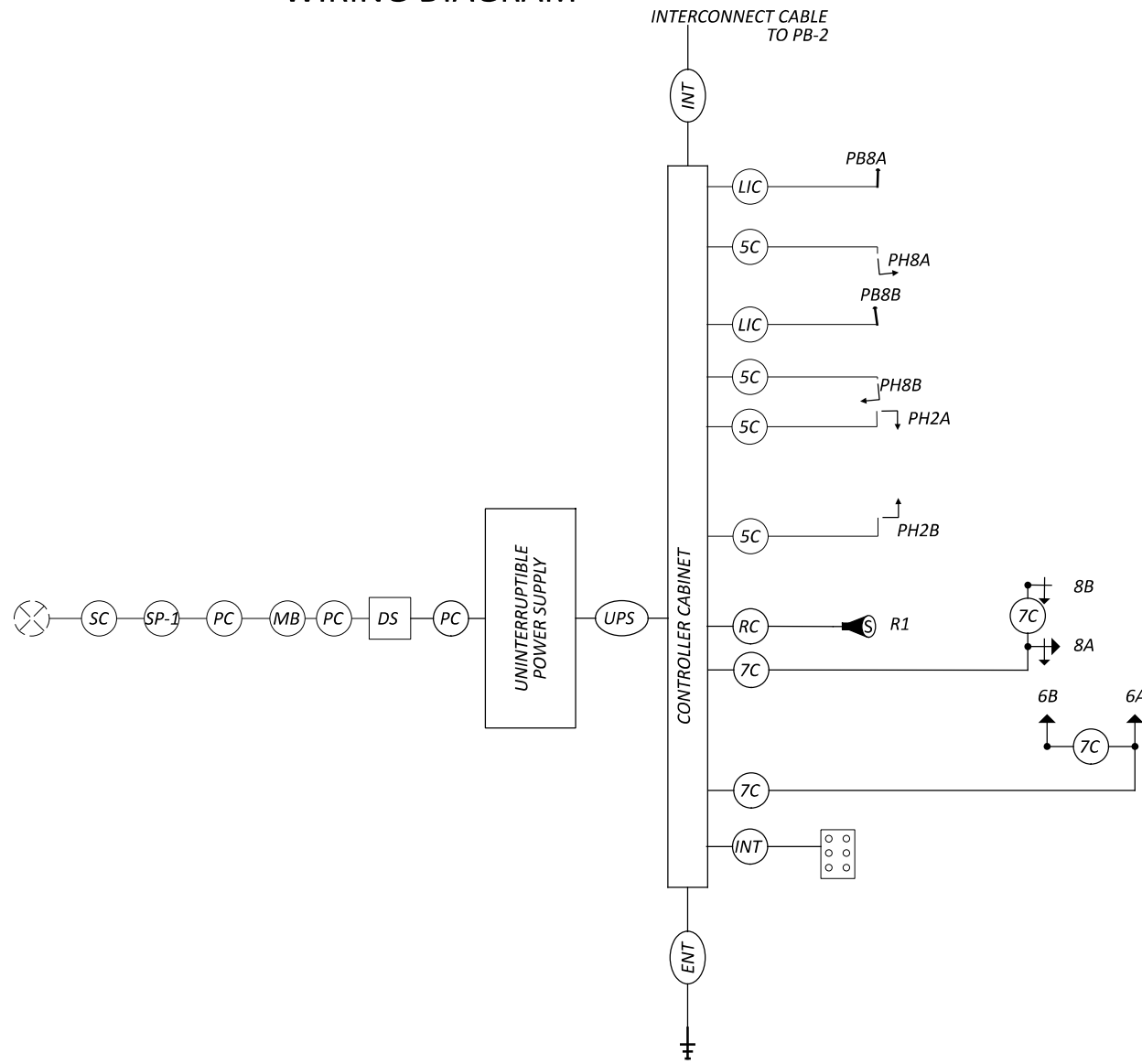

FIELD WIRING HOOKUP CHART

| SIGNAL HEAD | INDICATION | FIELD TERMINAL | FLASH | SIGNAL HEAD | INDICATION | FIELD TERMINAL | FLASH | | |
|--|------------|----------------|-------|-------------|------------|----------------|--------------|--------------|-----|
| 6A, 6B (SB) | R | 6R | R | - | | | | | |
| | Y | 6Y | | | | | | | |
| | G | 6G | | | | | | | |
| | - | - | | | | | | | |
| 8A (WB LT) | R | 8R/LS 15 R | R | - | | | | | |
| | Y | 8Y/LS 15 Y | | | | | | | |
| | G | 8G/LS 15 G | | | | | | | |
| | <--Y--- | 8Y/LS 15Y | | | | | | | |
| PEDESTRIAN MOVEMENTS | | | | | | | | | |
| 8B (WB LT) | <--R--- | 8R/LS 15R | R | - | PED-2 | W | 2 PED/LS 10G | OUT | |
| | <--Y--- | 8Y/LS 15Y | | | | DW | 2 PED/LS 10R | | |
| | <--G--- | 8G/LS 15G | | | | PED-8 | W | 8 PED/LS 11G | OUT |
| | - | - | | | | DW | 8 PED/LS 11R | | |
| OVERLAPS | | | | | | | | | |
| - | - | - | - | - | - | - | - | | |
| LS = LOAD SWITCH | | | | | | | | | |
| LS 15 IS ONLY ACTIVATED DURING TRACK CLEAR OF THE PREEMPTION - GREEN (ARROW /BALL) | | | | | | | | | |

LEGEND

| | | | | | |
|--|--|--|---------------------------------------|--|---------------------------------------|
| | TRAFFIC SIGNAL, 4 OR 5 UNIT HEAD, 12" | | 2/C NO. 14 AWG (LEAD-IN CABLE) | | SERVICE CABLE, 3 CONDUCTOR, NO. 4 AWG |
| | TRAFFIC SIGNAL, 3 UNIT HEAD, 12" | | SIGNAL CABLE, 5 CONDUCTOR, NO. 14 AWG | | POWER CABLE, 2 CONDUCTOR, NO. 4 AWG |
| | TRAFFIC SIGNAL, PROTECTED LEFT, 3 UNIT HEAD, 12" | | SIGNAL CABLE, 7 CONDUCTOR, NO. 14 AWG | | METER BASE |
| | PEDESTRIAN SIGNAL | | RADAR DETECTION CABLE | | SIGNAL DISCONNECT SWITCH |
| | PEDESTRIAN PUSH BUTTON | | 6-PAIR INTERCONNECT CABLE | | UNINTERRUPTIBLE POWER SUPPLY CABLE |
| | STOP LINE RADAR DETECTION UNIT | | POWER SOURCE | | SIGNAL SUPPORT POLE |
| | ETHERNET RADIO | | RAILROAD INDICATOR PANEL | | ETHERNET CABLE |

WAR-S RIVER & S MAIN NS

MODEL: Sheet_SurvFt_PAPER: 17x11 (in.) DATE: 6/7/2024 TIME: 2:08:14 PM USER: 02676 X:\4012500\220106.01\115153_VAR-STW-GES ORDC 2022\115153_WAR-S River & S Main NS\400-Engineering\Signals\Sheets\115153_CD003.dgn

TRAFFIC SIGNAL DETAILS
SOUTH RIVER ST & WEST 6TH ST

DESIGN AGENCY
Mead & Hunt
CLIENT

DESIGNER
TK

REVIEWER
DLW 06/07/24

PROJECT ID
115153

SHEET TOTAL
P.25 | 29

PEDESTRIAN SIGNAL HEADS



PROPOSED PEDESTRIAN SIGNAL HEADS
PH2A, PH2B
PH4A, PH4B
PH6A, PH6B
PH8A, PH8B

MAST ARM MOUNTED SIGNS



R3-1-24
S1 (2-SIGNS)
S1 ARE LED BLANKOUT SIGNS AND SHALL BE WIRED TO THE SIGNAL CONTROLLER.

PEDESTRIAN SIGNS



R10-3E-9
S4 (4-SIGNS)
2-LEFT ARROWS
2-RIGHT ARROWS

SIGNAL HEADS

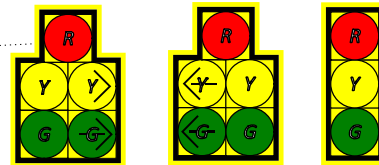

ALL SIGNAL HEADS SHALL BE 12" LED WITH BACKPLATES.

LED INTERNALLY ILLUMINATED SIGNS

SIGNS TO BE MOUNTED ON SIGNAL MAST ARM SP-1 AND ARE PAID UNDER THE TRAFFIC CONTROL QUANTITIES

S Main St

S3
D3-1, 78"X18" (SIGN FACE),
1-WAY LED INTERNALLY ILLUMINATED,
8" INCH "STANDARD HIGHWAY SERIES D" LETTERS

Sixth St

S2
D3-1, 72"X18" (SIGN FACE),
1-WAY LED INTERNALLY ILLUMINATED,
8" INCH "STANDARD HIGHWAY SERIES D" LETTERS

SIGNAL POLE & PEDESTRIAN POLE DETAILS

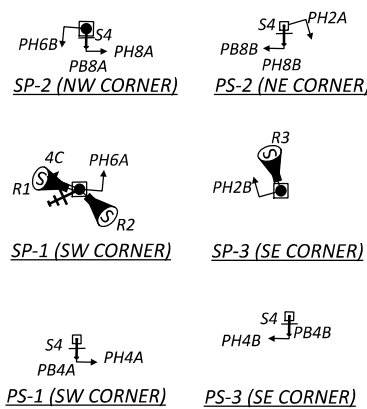

SP-2, SIGNAL SUPPORT TC-12.31, DESIGN 6 WITH MAST ARMS TC-81.22, 38' AND 35' W(2)-PED SIGNAL HEADS & (1)-PED PUSHBUTTON STA. 104+69, 39.8' LT. FOUNDATION INSTALLED BY OTHERS

EX. 19' CONDUIT, 4" INSTALLED BY OTHERS W/(2)-5/C, (1)-LIC & (1)-BLANKOUT POWER CABLE

EX. PULL BOX, 18" INSTALLED BY OTHERS

69' JACKED OR DRILLED CONDUIT, 725.051, 4" W/(1)-7/C, (5)-5/C, (2)-LIC & (1)-DETECTION POWER CABLE, (1)-BLANKOUT POWER CABLE THE NORTH PORTION OF THE CONDUIT WAS INSTALLED BY OTHERS

SP-1, SIGNAL SUPPORT TC-81.22, DESIGN 2 WITH 32' MAST ARM, W/(1)-METER & DISCONNECT SWITCH, (2)-STOP LINE RADAR UNIT, (1)-ETHERNET ANTENNA, (1)-3-SECTION SIGNAL HEAD, & (1)-PED SIGNAL HEAD STA. 104+57, 33.0' RT.

(2)-13' CONDUITS, 725.051, 4" 1-W/(2)-7/C, (1)-5/C, (1)-BLANKOUT POWER CABLE, (2)-DETECTION POWER CABLE (1)-ETHERNET RADIO CABLE 1-W/(2)-C-POWER CABLE

CONTROLLER WITH UPS STA. 104+57, 40' RT.

PS-1, SIGNAL SUPPORT TC-81.22, DESIGN 2 WITH 21' MAST ARM & (1)-PED SIGNAL HEAD, (1)-STOP LINE RADAR UNIT STA. 105+44, 31.5' RT.

8' CONDUIT, 725.051, 4" W/(1)-7/C & (1)-5/C (1)-DETECTION POWER CABLE

EX. PULL BOX, 18" INSTALLED BY OTHERS

PULL BOX, 725.08, 18" PB-2

4' CONDUIT, 725.051, 4" W/(1)-5/C, (1)-LIC

PS-3, SIGNAL SUPPORT TC-81.22, DESIGN 2 WITH 21' MAST ARM & (1)-PED SIGNAL HEAD & (1)-PED PUSHBUTTON STA. 105+20, 50.5' RT.

54' JACKED OR DRILLED CONDUIT, 725.051, 4" W/(1)-5/C, (1)-LIC

PS-1 PEDESTAL, 11' W(1)-PED SIGNAL HEAD & (1)-PED PUSHBUTTON STA. 104+57, 48.0' RT.

(3)-9' CONDUITS, 725.051, 4" 1-W/(3)-7/C, (8)-5/C & (4)-LIC, 1-W/(3)-DETECTION POWER CABLE, (1)-ETHERNET RADIO CABLE & (2)-BLANKOUT POWER CABLE 1-W/(1)-2/C POWER CABLE

10' CONDUIT, 725.051, 4" W/(1)-5/C, (1)-LIC

PB-1 PULL BOX, 725.08, 24"

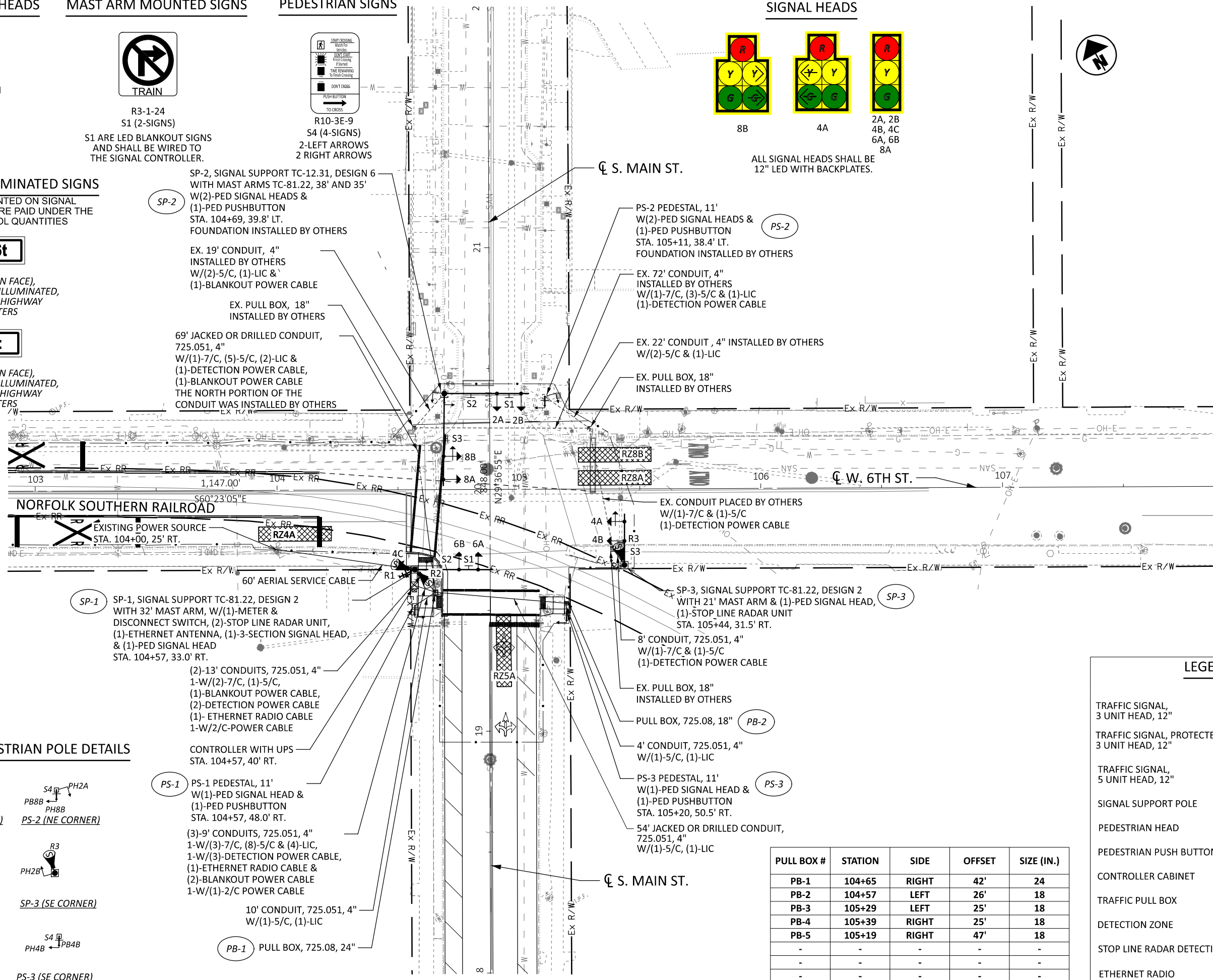

LEGEND

- TRAFFIC SIGNAL, 3 UNIT HEAD, 12"
- TRAFFIC SIGNAL, PROTECTED LEFT/RIGHT 3 UNIT HEAD, 12"
- TRAFFIC SIGNAL, 5 UNIT HEAD, 12"
- SIGNAL SUPPORT POLE
- PEDESTRIAN HEAD
- PEDESTRIAN PUSH BUTTON
- CONTROLLER CABINET
- TRAFFIC PULL BOX
- DETECTION ZONE
- STOP LINE RADAR DETECTION UNIT
- ETHERNET RADIO

| PULL BOX # | STATION | SIDE | OFFSET | SIZE (IN.) |
|------------|---------|-------|--------|------------|
| PB-1 | 104+65 | RIGHT | 42' | 24 |
| PB-2 | 104+57 | LEFT | 26' | 18 |
| PB-3 | 105+29 | LEFT | 25' | 18 |
| PB-4 | 105+39 | RIGHT | 25' | 18 |
| PB-5 | 105+19 | RIGHT | 47' | 18 |
| - | - | - | - | - |
| - | - | - | - | - |
| - | - | - | - | - |

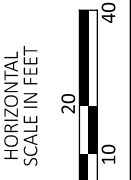

TRAFFIC SIGNAL PLAN
SOUTH MAIN STREET & WEST 6TH STREET

DESIGN AGENCY
Mead & Hunt
CLIENT

DESIGNER
DLW

REVIEWER
SJS 06/07/24

PROJECT ID
115153

SHEET TOTAL
P.26 29

SIGNAL TIMING CHART

TO BE COMPLETED ONCE PROJECTED TRAFFIC VOLUMES FOR SOUTH MAIN ST
TWO-WAY CONVERSION ARE PROVIDED BY THE CITY OF FRANKLIN

| INTERSECTION: WAR-S MAIN ST & W 6TH ST | | | | | | | | |
|--|---------------------|-------------------------|----|------------------|----|--------|----|---|
| MAINTAINING AGENCY: CITY OF FRANKLIN | | | | | | | | |
| START UP | | DUAL ENTRY: YES | | PHASES: 2&6, 4&8 | | | | |
| START IN: ALL RED | | REST IN RED: | | RING 1 | | RING 2 | | |
| TIME FOR FLASH OR ALL RED: 8 sec | | | | YES | | - | | |
| FIRST PHASE(S): 6 | | OVERLAP | | A | | B | | |
| COLOR DISPLAYED: GREEN | | PHASES | | - | | - | | |
| INTERVAL OR FEATURE | | CONTROLLER MOVEMENT NO. | | | | | | |
| INTERSECTION MOVEMENT (PHASE) | | 1 | 2 | 3 | 4 | 5 | 6 | 7 |
| DIRECTION | | - | NB | - | EB | - | SB | - |
| MINIMUM GREEN (INITIAL) (SEC.) | | | | | | | | |
| ADDED INITIAL *(SEC./ACTUATION) | | | | | | | | |
| MAXIMUM INITIAL (SEC.) | | | | | | | | |
| PASSAGE TIME (PRESET GAP) (SEC.) | | | | | | | | |
| TIME BEFORE REDUCTION *(SEC.) | | | | | | | | |
| MINIMUM GAP *(SEC.) | | | | | | | | |
| TIME TO REDUCE *(SEC.) | | | | | | | | |
| MAXIMUM GREEN I (SEC.) | | | | | | | | |
| MAXIMUM GREEN II (SEC.) | | | | | | | | |
| YELLOW CHANGE (SEC.) | | | | | | | | |
| ALL RED CLEARANCE (SEC.) | | | | | | | | |
| WALK (SEC.) | | | | | | | | |
| PEDESTRIAN CLEARANCE (SEC.) | | | | | | | | |
| RECALL | MAXIMUM (ON/OFF) | | | | | | | |
| | MINIMUM (ON/OFF) | | | | | | | |
| | PEDESTRIAN (ON/OFF) | | | | | | | |
| MEMORY (ON/OFF) | | | | | | | | |

*VOLUME DENSITY CONTROLS

NOTES:
1. COUNTDOWN PEDESTRIAN SIGNAL HEADS SHALL GO TO ZERO ON YELLOW PER OMUTCD FIGURE 4E-2.

RADAR DETECTION CHART

| DETECTION ZONE | RADAR NO. | MOVEMENT | PULSE OR PRESENCE | ASSOCIATED PHASE | DELAY PROGRAMMED IN CONTROLLER (SEC.) | EXTENSION PROGRAMMED IN CONTROLLER (SEC.) | DELAY INHIBITED PHASE | PURPOSE | DETECTION ZONE LENGTH (FT) |
|----------------|-----------|----------|-------------------|------------------|---------------------------------------|---|-----------------------|---------------------|----------------------------|
| RZ4A | R1 | EB | PRESENCE | 4 | | | | CALL/EXTEND PHASE 4 | 30' |
| RZ5A | R2 | NBLT | PRESENCE | 5 | | | | CALL/EXTEND PHASE 5 | 30' |
| RZ8A | R3 | WB | PRESENCE | 8 | | | | CALL/EXTEND PHASE 8 | 30' |
| RZ8B | R3 | WBRT | PRESENCE | 8 | | | | CALL/EXTEND PHASE 8 | 30' |

PHASING DIAGRAM

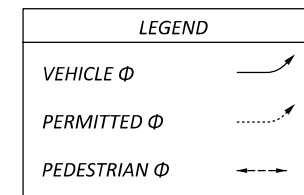
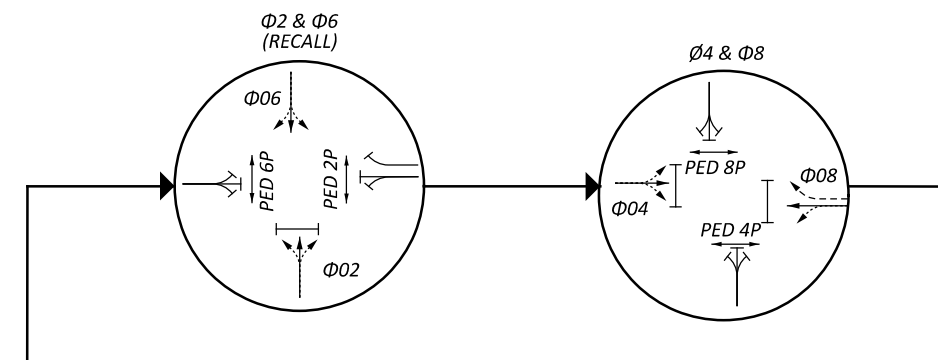

PREEMPTION PHASING DIAGRAM

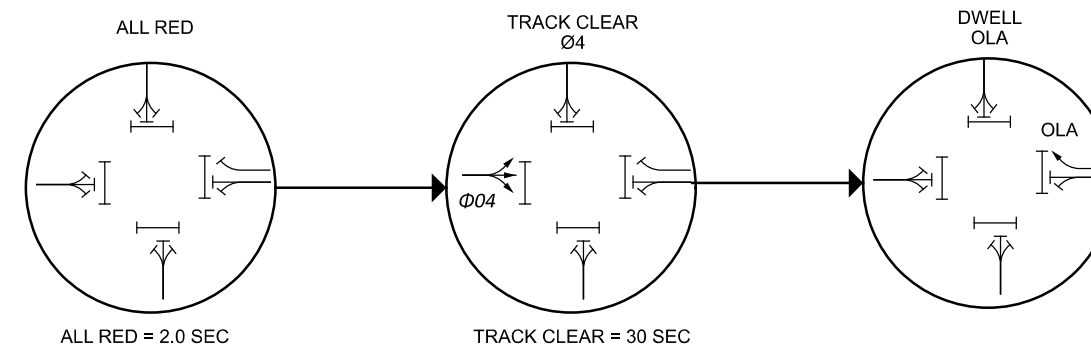

PEDESTRIAN PHASES OPERATING DURING THE PREEMPTION CALL SHALL BE TERMINATED.

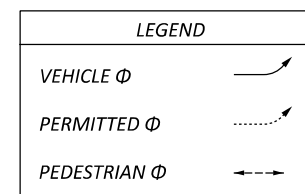

LED BLANKOUT SIGN S1 SHALL BE ACTIVE DURING ALL PHASES OF PREEMPTION

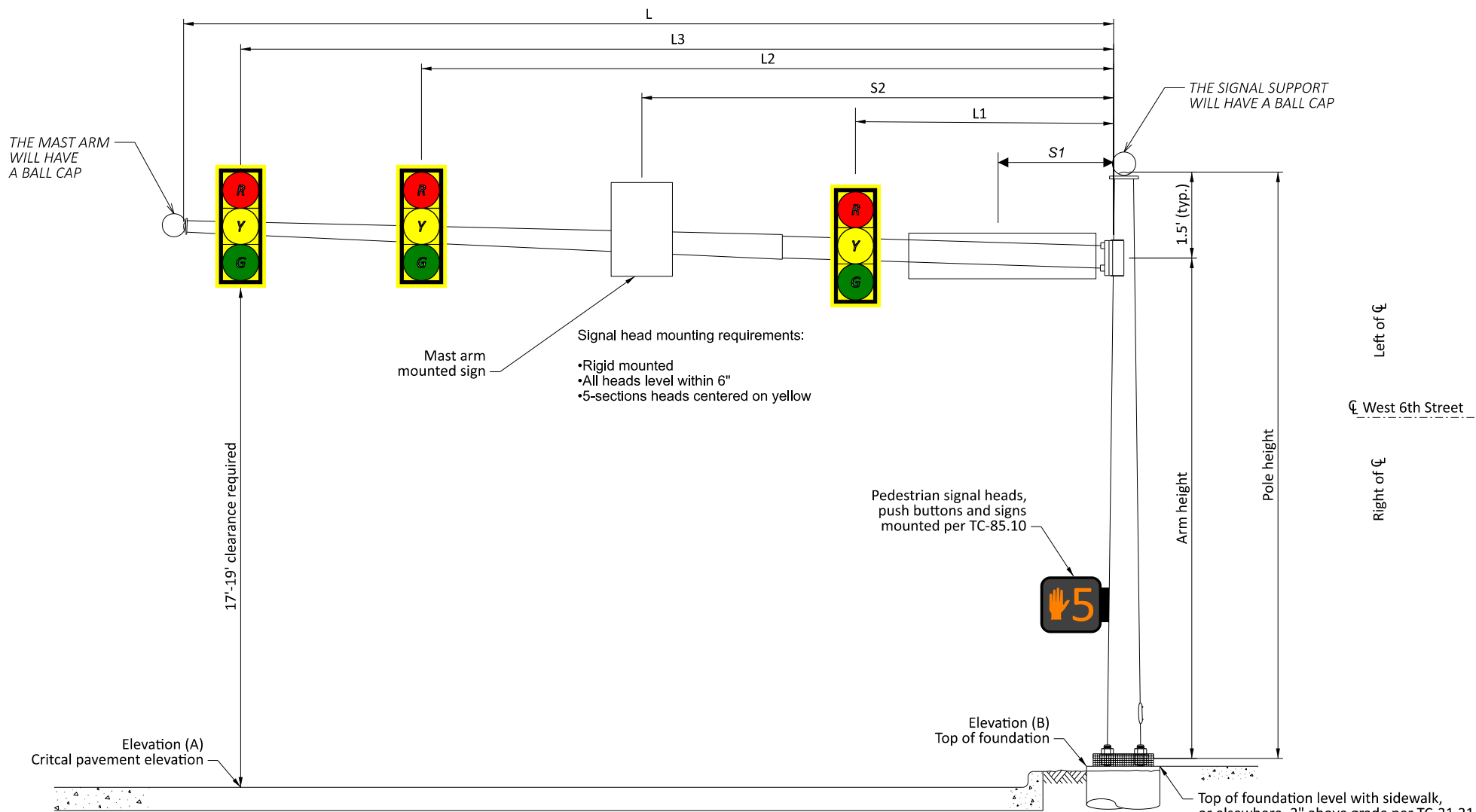

SIGNAL SUPPORT ELEVATION

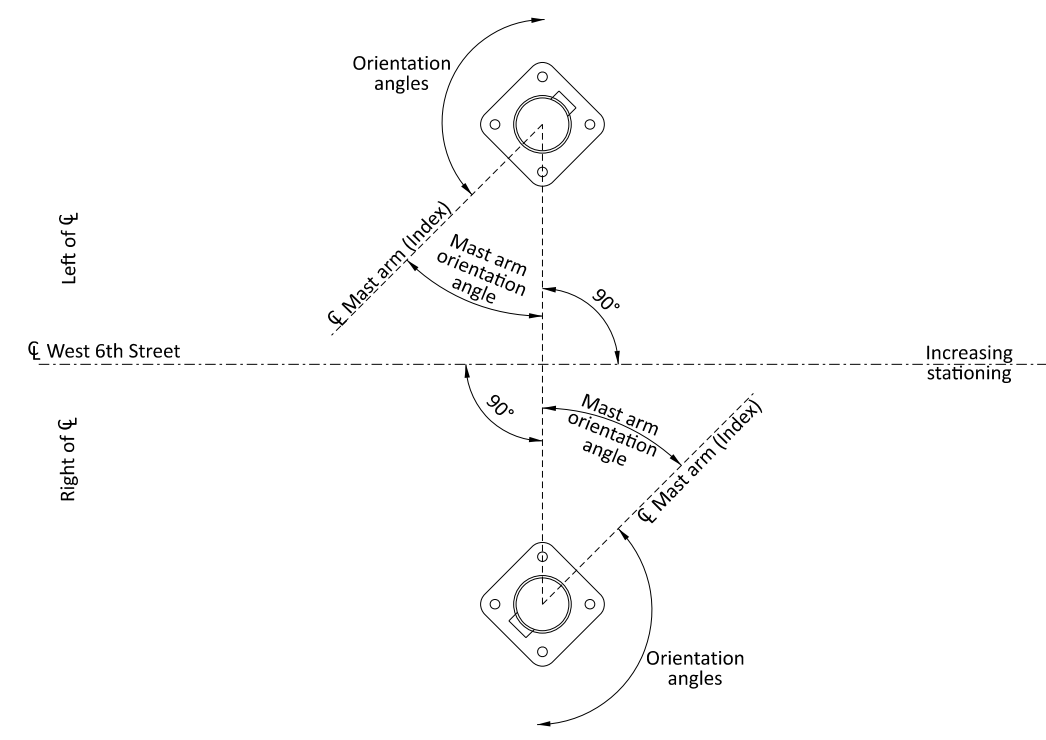

POLE ORIENTATION

MAST ARM TABLE

| SUPPORT NO. | STATION | OFFSET | ELEVATION | | SIGNAL SUPPORT DETAILS | | | | | | | | | | ORIENTATION ANGLES FROM MAST ARM | | | | | | | | | |
|--------------|---------|----------|-----------|--------|------------------------|------------|-------------|------------|----|----|----|----|----|----|----------------------------------|------------------|-------------------|-------------------|---------------|----------------------|----------|-----------------------------|--------------------------|-------------------|
| | | | A | B | DESIGN TYPE | DESIGN NO. | POLE HEIGHT | ARM HEIGHT | L | L1 | L2 | L3 | S1 | S2 | MAST ARM A ANGLE | MAST ARM B ANGLE | PEDESTRIAN SIGNAL | PEDESTRIAN BUTTON | POWER SERVICE | STOP LINE RADAR UNIT | HANDHOLE | CABLE ENTRANCE 12" FROM TOP | POLE MOUNTED SIGNAL HEAD | STOP BAR DETECTOR |
| | | | FT | FT | | | | | | | | | | | | | | | | | | | | |
| SP-1 | 104+57 | 33.0' RT | 681.43 | 681.76 | TC-81.22 | 4 | 21.5 | 20 | 32 | 18 | 26 | | 9 | 22 | 90 | - | 4 | - | 172 | 4/200 | 180 | 172 | | |
| SP-2 | 104+69 | 39.8' LT | | 680.97 | TC-12.31 | 6 | 23 | | | | | | | | 1 | - | 9/94 | 0 | - | | 90 | | | |
| SP-2 (ARM A) | | | 681.11 | | TC-81.21 | 4 | | 19.5 | 38 | 26 | 35 | | - | 14 | | | | | | | | | | |
| SP-2 (ARM B) | | | 680.92 | | TC-81.21 | 4 | | 21 | 35 | 21 | 32 | | 10 | 26 | | 270 | | | | | | | | |
| SP-3 | 105+44 | 31.5' RT | 681.75 | 682.03 | TC-81.22 | 2 | 21.5 | 20 | 21 | 10 | 18 | | 5 | | 0 | - | 254 | - | - | 343 | 180 | - | | |
| PS-1 | 104+57 | 48.0' RT | | | | | 11 | | | | | | | | | | 180 | 180 | | | 270 | | | |
| PS-2 | 105+11 | 38.4' LT | | | | | 11 | | | | | | | | | | 9/254 | 0 | | | 270 | | | |
| PS-3 | 105+20 | 50.5' RT | | | | | 11 | | | | | | | | | | 180 | 180 | | | 90 | | | |

WIRING DIAGRAM

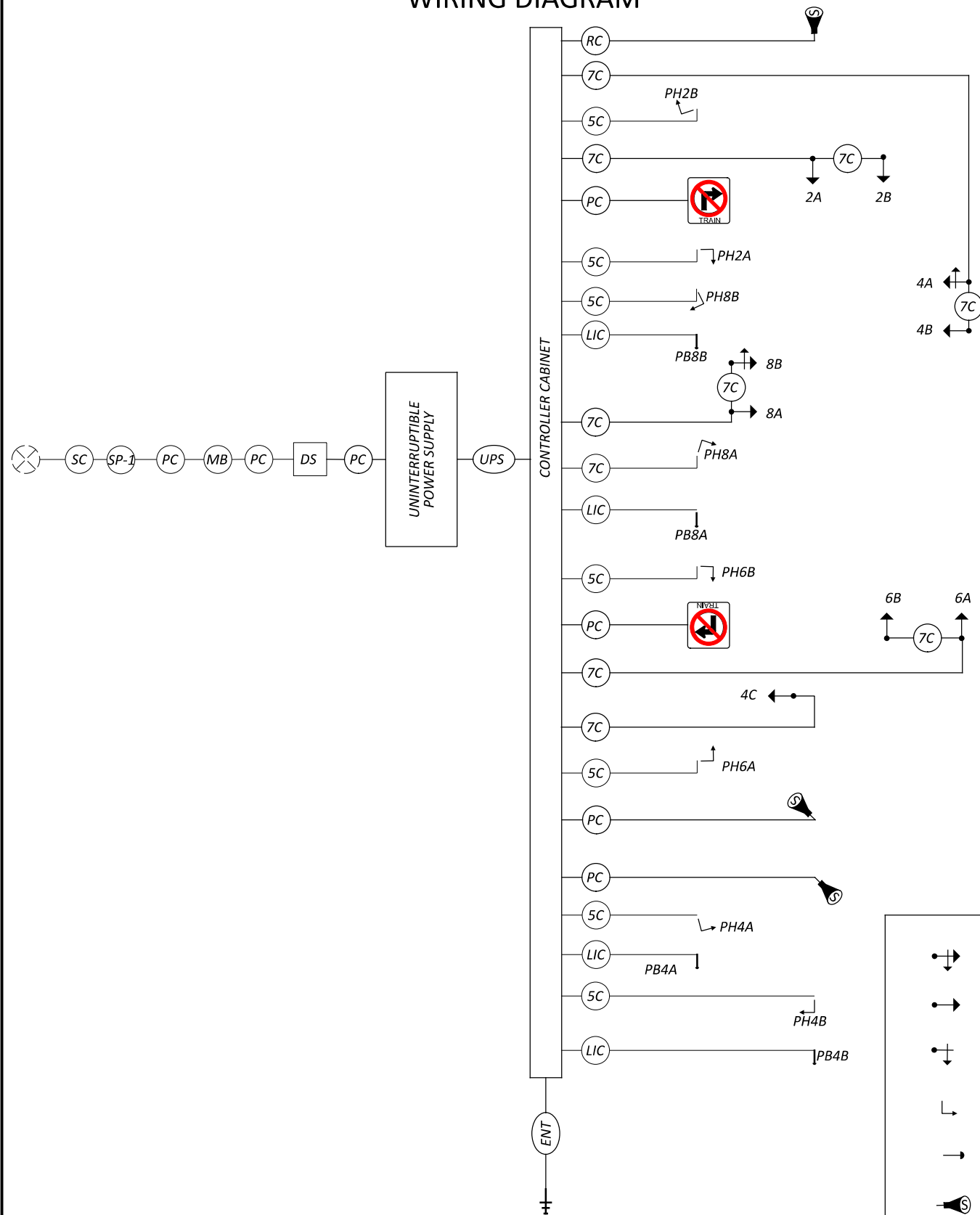

FIELD WIRING HOOKUP CHART

| SIGNAL HEAD | INDICATION | FIELD TERMINAL | FLASH | SIGNAL HEAD | INDICATION | FIELD TERMINAL | FLASH |
|----------------------|------------|----------------|---------|---------------|------------|----------------|-------|
| 2A, 2B (NB) | R | 2R | R | 8B (WB RT) | R | 8R | R |
| | Y | 2Y | | | Y | 8Y | |
| | G | 2G | | | G | 8G | |
| | - | - | | | ---Y--> | OLA | |
| | | | | | ---G--> | OLA | |
| 4B, 4C (EB) | R | 4R | R | 8A (WB) | R | 8R | R |
| | Y | 4Y | | | Y | 8Y | |
| | G | 4G | | | G | 8G | |
| | - | - | | | - | - | |
| | | | | | | | |
| | | | | 4A (EB LT) | R | 4R | R |
| | | | Y | | 4Y | | |
| | | | G | | 4G | | |
| | | | <--Y--> | | 4Y | | |
| | | | | <--G--> | 4G | | |
| PEDESTRIAN MOVEMENTS | | | | | | | |
| 6A, 6B (SB) | R | 6R | R | PED-2 | W | 2 PED/LS 10G | OUT |
| | Y | 6Y | | | DW | 2 PED/LS 10R | |
| | G | 6G | | PED-4 | W | 4 PED/LS 11G | OUT |
| | | | | | DW | 4 PED/LS 11R | |
| | | | | PED-6 | W | 6 PED/LS 12G | OUT |
| | | | | | DW | 6 PED/LS 12R | |
| | | | | PED-8 | W | 8 PED/LS/13G | OUT |
| | | | | | DW | 8 PED/LS 13R | |
| OVERLAPS | | | | | | | |
| | | | | OLA | ---Y--> | 8Y/LS 14Y | |
| | | | | | ---G--> | 8G/LS 14G | |
| | | | | S1 | | LS 14 R | OUT |

LS 14 IS ONLY ACTIVATED DURING TRACK CLEAR OF THE PREEMPTION - GREEN (ARROW /BALL)

LS 14 ACTIVATE DURING ALL PHASES OF PREEMPTION - LED BLANKOUT SIGN S1

LEGEND

| | | | | | |
|--|---|--|---------------------------------------|--|---------------------------------------|
| | TRAFFIC SIGNAL, 5 UNIT HEAD, 12" | | 2/C NO. 14 AWG (LEAD-IN CABLE) | | SERVICE CABLE, 3 CONDUCTOR, NO. 4 AWG |
| | TRAFFIC SIGNAL, 3 UNIT HEAD, 12" | | SIGNAL CABLE, 5 CONDUCTOR, NO. 14 AWG | | POWER CABLE, 2 CONDUCTOR, NO. 4 AWG |
| | TRAFFIC SIGNAL, PROTECTED LEFT/RIGHT 3 UNIT HEAD, 12" | | SIGNAL CABLE, 7 CONDUCTOR, NO. 14 AWG | | METER BASE |
| | PEDESTRIAN SIGNAL | | RADAR DETECTION CABLE | | SIGNAL DISCONNECT SWITCH |
| | PEDESTRIAN PUSH BUTTON | | 6-PAIR INTERCONNECT CABLE | | UNINTERRUPTIBLE POWER SUPPLY CABLE |
| | STOP LINE RADAR DETECTION UNIT | | POWER SOURCE | | SIGNAL SUPPORT POLE |
| | ETHERNET RADIO | | ETHERNET CABLE | | |
| | LED BLANKOUT SIGN (NO RIGHT TURN) | | | | |