

---

*Structure Type Study*

**COPY**

*SKT*

**Ramp B over Fairground Road**

**SCI-823-0.00**  
**PID No. 19415**

Prepared for  
**Ohio Department of Transportation**

July 2005

**CH2MHILL**

---

*Structure Type Study*

**Ramp B over Fairground Road**

**SCI-823-0.00**  
**PID No. 19415**

Prepared for  
**Ohio Department of Transportation**

July 2005

**CH2MHILL**

# TABLE OF CONTENTS

<u>Table of Contents</u>	<u>Page No.</u>
1. Introduction.....	2
2. Design Criteria.....	2
3. Bridge Transverse Section and Alignment.....	2
4. Proposed Maintenance of Traffic Solution.....	3
5. Evaluation of Structure Alternatives.....	3
6. Recommended Alternative.....	4
7. Subsurface Conditions and Foundation Recommendation.....	5

## APPENDIX A

- Cost Comparison Summary (3 Alternatives)

## APPENDIX B

- Preliminary Structure Site Plan – Alternative 2 (Sheet 1 of 3)
- Structural Details – Alternative 2 (Sheets 2 to 3 of 3)

## APPENDIX C

- Preliminary Vertical Clearance Calculations (3 Alternatives)

## APPENDIX D

- Preliminary Structure Site Plan – Alternative 1 (Sheet 1 of 1)
- Preliminary Structure Site Plan – Alternative 3 (Sheet 1 of 1)

## APPENDIX E

- Preliminary Structural Foundation Recommendations (DLZ)

## **1. Introduction**

Three (3) alternatives for construction of the proposed Ramp B bridge over Fairground Road have been evaluated in this Structure Type Study, and are designated (in no particular order) Alternatives 1 through 3. All three alternatives involve construction of the proposed bridge on a single-span layout. Alternative 1 consists of a long span bridge deck supported by conventional stub abutments on spill through slopes constructed in fill. Alternatives 2 and 3 consist of a short, single-span bridge with tall Mechanically Stabilized Earth (MSE) abutments located outside of the horizontal clear zone. These MSE walls would be continuous and serve as the rear and forward abutment breastwalls for the Ramp B bridge over Fairground Road, as well as for both the adjacent SR-823 Mainline and Ramp C bridges over Fairground Road. Taking into consideration the horizontally curved geometry of Ramp B, the long span of Alternative 1 requires a curved steel plate girder superstructure, while the short spans of Alternatives 2 and 3 allow for the use of a straight prestressed concrete I-beam superstructure and a tangent structural steel rolled beam superstructure, respectively.

A fourth alternative, consisting of a three-span bridge, was also considered; however, the analysis is not presented in this document. As part of the SCI-823-0.00 project, three roadway alignments, SR-823 Mainline, Ramp B, and Ramp C, pass over the existing Fairground Road. Due to the close proximity of the three roadway alignments at the proposed grade separations over Fairground Road, it is important from a construction, maintenance, and overall aesthetic standpoint to use similar structure types for the three bridges. Because the existing Fairground Road is a lightly-traveled, two-lane rural road, the required clear span is relatively short, and single-span alternatives are assumed to provide the most cost-effective structure. This assumption was verified by analyzing a three-span alternative behind spill-through slopes for the SR-823 Mainline bridge over Fairground Road (for details, see separate Structure Type Study for the SR-823 Mainline bridge). The results show that a three-span alternative is excessive in both initial construction and life-cycle maintenance costs. Therefore, three-span structure alternatives have been ruled out as economical structure types for the proposed Ramp B bridge over Fairground Road.

Each alternative was evaluated with regard to estimated construction cost, projected maintenance costs, horizontal and vertical clearances, aesthetics, constructability, and maintenance of traffic. Based on these evaluations, one alternative is recommended for further design development in the Bridge Preliminary Design Report stage.

## **2. Design Criteria**

All proposed structure types are in accordance with the most current version of the Ohio Department of Transportation Bridge Design Manual, the 2002 AASHTO Standard Specifications for Highway Bridges, 17<sup>th</sup> edition, and the 2003 AASHTO Guide Specifications for Horizontally Curved Steel Girder Highway Bridges.

## **3. Bridge Transverse Section and Alignment**

At the proposed bridge location, Ramp B follows an 11°15'00" horizontal curve (509.30-foot radius) to the right. The proposed section consists of one 16-foot lane, a 6-foot left shoulder,

and an 8-foot right shoulder. With two 1'-6" wide single slope outside deflector parapets, the out-to-out deck width is a constant 33'-0" for all alternatives. The Ramp B bridge will be superelevated, with a constant superelevation rate of 8.3 percent across the entire length of the proposed structure.

The proposed Ramp B vertical alignment over Fairground Road consists of a +2.20 percent slope for a majority of the bridge structure, followed by a 150-foot sag vertical curve at the forward approach.

The existing Fairground Road will remain on the existing horizontal alignment and vertical grade under the bridge, and will not be constructed as part of the project except as required for restoration after construction of the new bridge.

#### **4. Proposed Maintenance of Traffic Solution**

The proposed Ramp B alignment will carry traffic exiting northbound US-23 onto eastbound SR-823. Because the Ramp B alignment is new construction, maintenance of traffic during construction of the Ramp B bridge over Fairground Road will be limited. With the exception of limited Fairground Road closure for superstructure beam setting, as well as traffic safety precautions throughout bridge construction, no additional maintenance of traffic solutions will need to be investigated.

#### **5. Evaluation of Structure Alternatives**

##### **Common Considerations**

Construction costs for each alternative have been developed for an identical length of improvement, equal to the length of the longest alternative. Estimated construction costs for each alternative include all proposed work between these limits. The vertical profile of Ramp B is controlled by the crossing over the Norfolk Southern Railway to the west of the proposed structure over Fairground Road. As a result, vertical clearance over Fairground Road greatly exceeds the 17'-0" minimum, and no additional costs associated with profile adjustments are necessary. Other estimated construction costs not included in the cost estimate include provisions for the reconstruction of Fairground Road (if required due to construction impacts) and maintenance of traffic cost differentials.

The existing Fairground Road section is an uncurbed roadway, with an edge of pavement to edge of pavement width of approximately 21'-0" and a design speed of 40 mph.

Substructures along Fairground Road for alternatives consisting of spill-through slopes are located outside the minimum preferred horizontal clear zone width of 8'-0". Substructures consisting of abutments behind MSE walls are located outside the minimum preferred horizontal clear zone width of 10'-0" to the face of MSE wall.

##### **Alternative 1**

Alternative 1 consists of a 120.84 foot single-span bridge with rear and forward abutments on steel H-piles behind spill-through 2:1 slopes. Both abutment faces are tangent and parallel to the Fairground Road centerline. Due to the large skew and horizontal curvature of Ramp B, a prestressed concrete superstructure using straight beams is not feasible. Instead, the proposed superstructure will consist of four horizontally curved, parallel steel plate girders, using Grade 50 steel members spaced at 9'-0" and having a web depth of 48".

Due to the fact that the superstructure is horizontally curved, conventional jointed abutments will be required at the rear and forward abutments.

The initial bridge construction cost for Alternative 1 is estimated to be \$791,000 in year 2008 dollars. The present value life cycle maintenance costs for this alternative are estimated to be \$345,000, resulting in a total estimated ownership cost of \$1,136,000 in year 2008 dollars.

### **Alternative 2**

Alternative 2 consists of a 51.88 foot single-span bridge with rear and forward semi-integral stub abutments behind tall MSE abutment breastwalls constructed outside the minimum preferred Fairground Road lateral clearance. The rear and forward abutment breastwalls will be parallel to the Fairground Road centerline. While it is possible to construct an MSE retaining wall with semi-integral stub abutments on steel H-piles, both the rear and the forward abutments are assumed to be founded on spread footings for this analysis. In the Preliminary Design Report submission, the footing width will need to be sized accordingly to satisfy the maximum bearing pressure of 4,000 psf, as required by the AASHTO specifications and ODOT Bridge Design Manual. For Alternative 2, the superstructure will consist of four tangent 36"-deep AASHTO Type 2 prestressed concrete beams spaced at 9'-0" on center.

The initial bridge construction cost for Alternative 2 is estimated to be \$648,000 in year 2008 dollars. The present value life cycle maintenance costs for this alternative are estimated to be \$98,000, resulting in a total estimated ownership cost of \$746,000 in year 2008 dollars.

### **Alternative 3**

Alternative 3 also consists of a 51.88 foot single-span bridge with rear and forward semi-integral stub abutments behind tall MSE abutment breastwalls constructed outside the minimum preferred Fairground Road lateral clearance. The rear and forward abutment breastwalls will be parallel to the Fairground Road centerline. While it is possible to construct an MSE retaining wall with semi-integral stub abutments on steel H-piles, both the rear and the forward abutments are assumed to be founded on spread footings for this analysis. In the Preliminary Design Report submission, the footing width will need to be sized accordingly to satisfy the maximum bearing pressure of 4,000 psf, as required by the AASHTO specifications and ODOT Bridge Design Manual. For Alternative 3, the superstructure will consist of four tangent W24 steel rolled beams, using Grade 50 steel members spaced at 9'-0" on center.

The initial bridge construction cost for Alternative 3 is estimated to be \$649,000 in year 2008 dollars. The present value life cycle maintenance costs for this alternative are estimated to be \$130,000, resulting in a total estimated ownership cost of \$779,000 in year 2008 dollars.

## **6. Recommended Alternative**

Three (3) structural solutions (excluding three-span alternatives previously mentioned) for the construction of the proposed Ramp B alignment over Fairground Road have been evaluated in this structure type study. All alternatives provide comparable operational characteristics and meet minimum horizontal clearance requirements. Due to the fact that the proposed Ramp B grade separation structure over the Norfolk Southern Railway west of

Fairground Road controls the vertical profile for vertical clearance, no differential costs associated with profile adjustments have been considered in the aforementioned alternatives. Based on lower estimated total ownership costs, **CH2M HILL recommends that the single-span bridge of ALTERNATIVE 2, using tall MSE walls and prestressed concrete I-beams, be constructed for the Ramp B bridge over Fairground Road.**

## **7. Subsurface Conditions and Foundation Recommendation**

Subsurface investigations for the SCI-823-0.00 project will be conducted in two, possibly three, phases. The first mobilization is complete, and included all of the proposed pavement and embankment borings, and a limited number of bridge borings. The second mobilization will include the remaining bridge borings (if necessary), and the majority of the proposed MSE retaining wall borings. If required, a third mobilization will target specific boring locations or in-situ testing recommended in the bridge and retaining wall Preliminary Design Report submissions.

Three borings at the Ramp B bridge over Fairground Road were taken during the first mobilization. Based on these initial borings, geotechnical subconsultant DLZ has made preliminary foundation recommendations for the Ramp B structure. Copies of the preliminary report are included with this submission.

The recommended alternative, Alternative 2, consists of semi-integral stub abutments supported behind MSE retaining walls for the single-span bridge. Both abutments are assumed to be supported on spread footings resting directly on the MSE select granular fill to avoid conflicts with the MSE reinforcing straps. If pile foundations are required and used, the piles are envisioned to be HP 14x73 H-pile sections driven to bedrock refusal. The pile spacing is assumed to be 7'-6" to allow for convenient staggering of the piles between MSE reinforcing in 5'-0" standard square wall panels. An alternative to driven H-piles would be the use of drilled shafts extending to bedrock.

Final foundation size, capacity, and possible pile length recommendations will be made upon completion of the remaining bridge and retaining wall borings, and will be included with the bridge Preliminary Design Report submission.

APPENDIX A

Cost Comparison Summary



**SCI-823-0.00**  
**Ramp B Over Fairground Road**  
**STRUCTURE TYPE STUDY**

Filename: \\Aries\Proj\TranSystems\319861\19415\structures documents\Step 7 - Type Study\Bridge SCI823-1593C Ramp B over Fairground\Structure Cost Comparison.xls\Alternative Summary  
 By: SKT  
 Date: 07/06/2005  
 Checked:

**COST COMPARISON SUMMARY**

Alternative No.	Span Arrangement No. Spans	Lengths	Framing Alternative	Proposed Stringer Section	Total Initial Superstructure Cost	Total Initial Substructure Cost	Total Initial Construction Cost	Superstructure Life Cycle Maintenance Cost	Total Relative Ownership Cost
1	1	120.84	4 ~ Curved Steel Plate Girders	48" Web - Grade 50	\$417,000	\$151,000	\$791,000	\$345,000	\$1,136,000
2	1	51.88	4 ~ P.S. Concrete I-Beams	AASHTO Type 2	\$129,000	\$320,000	\$648,000	\$98,000	\$746,000
3	1	51.88	4 ~ Steel Rolled Beams	W24 - Grade 50	\$127,000	\$323,000	\$649,000	\$130,000	\$779,000

SCI-823-0.00

Ramp B Over Fairground Road

STRUCTURE TYPE STUDY

Filename: C:\Documents and Settings\brown3\Local Settings\Temporary Internet Files\OLK7\Structure Cost Comparison.xls]Alternative Summary  
 By: SKT Date: 07/06/2005  
 Checked: Date:

ALTERNATIVE COST SUMMARY

Alternative No.	Span Arrangement	Total Average Span Length (ft.)	Framing Alternative	Proposed Stringer Section	Subtotal Superstructure Cost	Subtotal Substructure Cost	Approach Roadway Length (1)	Approach Roadway Cost (2, 3)	Structure Incidental Cost (16%)	Structure Contingency Cost (20%)	Roadway Incidental & Contingency Cost (30%)	Total Initial Construction Cost	Superstructure Life Cycle Maintenance Cost	Total Relative Ownership Cost
1	120.84	120.84	4 ~ Curved Steel Plate Girders	48" Web - Grade 50	\$417,000	\$151,000	0.0	\$0	\$91,000	\$132,000	\$0	\$791,000	\$345,000	\$1,136,000
2	51.88	51.88	4 ~ P.S. Concrete I-Beams	AASHTO Type 2	\$129,000	\$320,000	69.0	\$18,000	\$72,000	\$104,000	\$5,000	\$648,000	\$98,000	\$746,000
3	51.88	51.88	4 ~ Steel Rolled Beams	W24 - Grade 50	\$127,000	\$323,000	69.0	\$18,000	\$72,000	\$104,000	\$5,000	\$649,000	\$130,000	\$779,000

NOTES:

- Approach roadway length equals the difference between the maximum bridge length and the bridge length for the alternative being considered.
- Use 2004 pavement cost = \$33.20 /sq. yd. Allow 3.5% escalation for years 2005 - 2008  
 2008 Unit Cost = \$38.10 /sq. yd.
- Pavement Widths:  

Alternative	Average Rear Approach	Average Fwd. Approach	Combined Average	2008 Unit Cost =
Alt. 1	33.00 ft.	33.00 ft.	33.00 ft.	\$50.30 /ft.
Alt. 2	33.00 ft.	33.00 ft.	33.00 ft.	\$57.70 /ft.
Alt. 3	33.00 ft.	33.00 ft.	33.00 ft.	
- Use 2004 Concrete Barrier, Single Slope, Type B1 cost = \$50.30 /ft.  
 Allow 3.5% escalation for years 2005 - 2008
- Structure incidental cost allowance includes provision for structure excavation, porous backfill & drainage pipe, sealing of concrete surfaces, structural steel painting, bearings, (minor) temporary shoring, crushed aggregate slope protection, pile driving equipment mobilization, shear connectors, settlement platforms, expansion joints, joint sealers, and joint fillers costs.
- Roadway incidental cost allowance includes provision for drainage, maintenance of traffic, and traffic control costs.
- Estimated construction cost does not include existing structure removal, which should be quantified separately, if required.
- No profile adjustment costs associated with raising the Ramp B profiles have been considered, since all alternatives satisfy the minimum required vertical clearance of 17'-0" for steel structures and 17'-0" for concrete structures.

Vertical Clearance

Alternative	Provided (ft.)	Required (ft.)
Alt. 1	21.07 ft.	0.00 ft.
Alt. 2	22.20 ft.	0.00 ft.
Alt. 3	23.28 ft.	0.00 ft.

**SCI-823-0.00**  
**Ramp B Over Fairground Road**  
**STRUCTURE TYPE STUDY**

Filename: C:\Documents and Settings\brown3\Local Settings\Temporary Internet Files\OLK7\Structure Cost Comparison.xls\Alternative Summary  
 Date: 07/06/2005  
 By: SKT  
 Checked:

**SUPERSTRUCTURE**

Alternative No.	Span Arrangement		Total Average Span Length (ft.)	Deck Length (ft.)	Deck Area (sq. ft.)	Deck Volume (cu. yd.)	Deck Concrete Cost	Deck Reinforcing Cost	Approach Slab Cost	Framing Alternative	Proposed Stringer Section	Structural Steel Weight (pounds)	Structural Steel Cost	Prestressed Girder Cost	Initial Superstructure Cost
	No. Spans	Lengths													
1	1	120.84	120.84	122.84	4,100	156	\$93,300	\$39,100	\$30,300	4 ~ Curved Steel Plate Girders	48" Web - Grade 50	164000.0	\$254,100	\$0	\$417,000
2	1	51.88	51.88	53.88	1,800	68	\$40,900	\$17,100	\$30,300	4 ~ P.S. Concrete I-Beams	AASHTO Type 2	0.0	\$0	\$40,900	\$129,000
3	1	51.88	51.88	53.88	1,800	68	\$40,900	\$17,100	\$30,300	4 ~ Steel Rolled Beams	W24 - Grade 50	45000.0	\$38,200	\$0	\$127,000

**Deck Cross-Sectional Area:**

Parapets:	No.	Individual Area (sq. ft.)		Parapet Area (sq. ft.)
		Area	W (ft.)	
Parapets	2	4.26	33.00	8.52
Median	0	9.29	0.00	0.00
Slab:				
Alt. 1		0.71	33.00	23.4
Alt. 2		0.71	33.00	23.4
Alt. 3		0.71	33.00	23.4
				<b>Total Concrete Area (sq. ft.)</b>
				34.2
				34.2
				34.2

Note: Deck width measured as average width.  
 10% of deck area allowed for haunches and overhangs.

**QC/QA Concrete, Class QSC2**

Unit Cost (\$/cu. yd.):	Year	
	2004	2008
Deck	\$491.00	\$563.00
Parapets	\$615.00	\$706.00
Weighted Average =		\$599.00

Based on parapet and slab percentages of total concrete area

**Epoxy Coated Reinforcing Steel**

Unit Cost (\$/lb.):	Year	
	2004	2008
Assume 285 lbs of reinforcing steel per cubic yard of deck concrete		
Deck Reinforcing	\$0.77	\$0.88

**Prestressed Concrete Girders**

Unit Costs:	Year		No. Required
	2004	2008	
AASHTO Type 2 Beams			
Type 2 I-Beams (36")	\$8,000 ea.	3.5%	4
Pier Diaphragms	\$1,800 ea.	3.5%	0
Abutment Diaphragms	\$1,200 ea.	3.5%	0
Intermediate Diaphragms	\$1,200 ea.	3.5%	3

**Structural Steel**

Unit Costs (\$/lb.):	Year		Annual Escalation
	2004	2008	
Ratio			
Rolled Beams - Grade 50	n/a	\$0.74	3.5%
Plate Girders - Grade 50	n/a	\$1.20	3.5%
Curved Plate Girders - Grade 50	n/a	\$1.35	3.5%
Hybrid Plate Girders - Grade 50/70W	1.10	\$1.32	3.5%

Note - all structural steel weight will be estimated at 40 pounds per each square foot of bridge deck area for curved girders.  
 and 25 pounds per each square foot of bridge deck area for tangent girders.

**Reinforced Concrete Approach Slabs (T=15")**

Unit Cost (\$/sq. yd.):  
 Length = 25 ft. Ave. Width = 33.00 ft.  
 Area = 92 sq. yd.

Approach Slabs	Year	
	2004	2008
Unit Cost	\$144.00	\$165.00
Annual Escalation	3.5%	

**SUBSTRUCTURE**

Alternative No.	Span Arrangement No. Spans	Lengths	Framing Alternative	Proposed Stringer Section	Pier Concrete Cost	Pier Reinforcing Cost	Abutment Concrete Cost	Abutment Reinforcing Cost	Pier Foundation Cost	MSE Abutment & Wingwall Cost	Temporary Shoring Cost	Initial Substructure Cost
1	1	120.84	4 - Curved Steel Plate Girders	48" Web - Grade 50	\$0	\$0	\$87,400	\$14,300	\$49,600	\$0	\$0	\$151,000
2	1	51.88	4 - P.S. Concrete I-Beams	AASHTO Type 2	\$0	\$0	\$82,500	\$13,500	\$0	\$224,000	\$0	\$320,000
3	1	51.88	4 - Steel Rolled Beams	W24 - Grade 50	\$0	\$0	\$74,900	\$12,300	\$0	\$235,300	\$0	\$323,000

**Pier QC/QA Concrete, Class QSC1 Cost:**

Component	Volume (cu.yd.)	Year 2004	Annual Escalation	Year 2008	Total Cost
Cap	0.0	\$421.00	3.5%	\$483.00	\$0
Columns	0.0	\$421.00	3.5%	\$483.00	\$0
Footings	0.0	\$421.00	3.5%	\$483.00	\$0
Total Pier Cost					\$0 Each Pier

**Abutment QC/QA Concrete, Class QSC1 Cost:**

Component	Volume (cu.yd.)	Year 2004	Annual Escalation	Year 2008	Total Cost
Abutment	59.7	\$421.00	3.5%	\$483.00	\$28,800
Wingwalls	56.3	\$421.00	3.5%	\$483.00	\$27,200
Wingwalls	35.4	\$421.00	3.5%	\$483.00	\$17,100
Wingwalls	29.6	\$421.00	3.5%	\$483.00	\$14,300

**Alt. 2**

Component	Volume (cu.yd.)	Year 2004	Annual Escalation	Year 2008	Total Cost
Abutment	51.0	\$421.00	3.5%	\$483.00	\$24,600
Wingwalls	51.0	\$421.00	3.5%	\$483.00	\$24,600

**Alt. 3**

Component	Volume (cu.yd.)	Year 2004	Annual Escalation	Year 2008	Total Cost
Abutment	47.0	\$421.00	3.5%	\$483.00	\$22,700
Wingwalls	47.0	\$421.00	3.5%	\$483.00	\$22,700

**Epoxy Coated Reinforcing Steel**

Unit Cost (\$/lb):	Assume	Year 2004	Annual Escalation	Year 2008
125	lbs of reinforcing steel per cubic yard of pier concrete.	\$0.77	3.5%	\$0.88
90	lbs of reinforcing steel per cubic yard of abutment concrete.	\$0.77	3.5%	\$0.88

**MSE Abutment Unit Cost (\$/sq. ft.):**

Alt.	Rear Abutment Area (sq. ft.)	Forward Abutment Area (sq. ft.)	Total Cost
Alt. 1	0	0	\$0
Alt. 2	1,843	1,770	\$224,000
Alt. 3	1,941	1,854	\$235,300

**Temporay Shoring and Temporary MSE Wall**

Unit Costs (\$/sq. ft.):	Temp. Shoring Area (sq. ft.)	Temp. MSE Wall Area (sq. ft.)	Total Cost
Alt. 1	0	0	\$0
Alt. 2	0	0	\$0
Alt. 3	0	0	\$0

**Abutment Piles:**

Alt.	Number	Year 2004	Annual Escalation	Year 2008	Total Cost
Alt. 1	18	\$24.41	3.5%	\$28.00	\$504.00
Alt. 2	0	\$11.57	3.5%	\$13.30	\$0
Alt. 3	0				\$0
Total					\$41.30

**SCI-823-0.00**  
**Ramp B Over Fairground Road**  
**STRUCTURE TYPE STUDY**

Filename: C:\Documents and Settings\brown3\Local Settings\Temporary Internet Files\OLK\Structure Cost Comparison.xls\Alternative Summary  
By: SKT Date: 07/06/2005  
Checked:

**LIFE CYCLE MAINTENANCE COST**

Alt. No.	Span Arrangement No. Spans	Span Lengths	Framing Alternative	Structural Steel Painting			Superstructure Sealing			Approach Pavement Resurfacing		
				Cost Per Cycle	Number of Maintenance Cycles	Total Life Cycle Cost	Cost Per Cycle	Number of Maintenance Cycles	Total Life Cycle Cost	Cost Per Cycle	Number of Maintenance Cycles	Total Life Cycle Cost
1	1	120.84	4 - Curved Steel Plate Girders	\$64,200	2	\$128,400	\$0	0	\$0	\$0	0	\$0
2	1	51.88	4 - P.S. Concrete I-Beams	\$0	0	\$0	\$2,300	2	\$4,600	\$1,200	7	\$8,400
3	1	51.88	4 - Steel Rolled Beams	\$18,100	2	\$36,200	\$0	0	\$0	\$1,200	7	\$8,400

Alt. No.	Span Arrangement No. Spans	Span Lengths	Framing Alternative	Bridge Deck Overlay (5)			Bridge Redecking (5)			Superstructure Life Cycle Maintenance Cost (1)	Total Initial Construction Cost	Total Relative Ownership Cost
				Deck Demo & Chipping	Deck Overlay	Deck Joint Gland (2)	Deck Reinforcing Cost (3)	Deck Concrete Cost (3)	Bridge Deck Joint Cost (2)			
1	1	120.84	4 - Curved Steel Plate Girders	\$12,400	\$15,100	\$4,500	\$93,300	\$18,000	\$33,900	\$345,000	\$791,000	\$1,136,000
2	1	51.88	4 - P.S. Concrete I-Beams	\$5,500	\$6,600	\$0	\$40,900	\$0	\$14,900	\$98,000	\$648,000	\$746,000
3	1	51.88	4 - Steel Rolled Beams	\$5,500	\$6,600	\$0	\$40,900	\$0	\$14,900	\$130,000	\$649,000	\$779,000

**Structural Steel Painting:**  
Structural Steel Area:  
Total Span Length (ft.) 120.84  
Assumed Ave. Bot. Flange Width (in.) 12.00  
Total Exposed Steel Area (sq. ft.) 6,400  
Secondary Member Allowance 20%  
Total Exposed Steel Area (sq. ft.) 1,800

**Painting Cost per sq. ft.:**  
Year 2004 \$5.00  
Year 2008 \$5.74  
Annual Escalation 3.5%  
Prep \$1.25  
Prime \$1.43  
Intermed. \$1.25  
Finish \$1.43  
Total \$10.03

**Superstructure Sealing:**  
PS Concrete I-Beam Area:  
36" AASHTO Type 2  
Bot. Flange H 18 V 6 No. 1 Total 18.00  
Lower Fillels 6 6 8.49 2 12.00  
Web 15 3 30.00  
Upper Fillels 3 3 8.49 2 12.00  
Top Flange 6 6 12.00  
Total Exposed Perimeter 97.47 in.

**PS Concrete Area:**  
Total Span Length (ft.) 51.88  
Nominal Exposed Beam Area (sq. ft.) 1,685  
Secondary Member Allowance 10%  
Total Exposed Concrete Area (sq. vd.) 210

**Sealing Cost per sq. vd.:**  
Year 2004 \$9.68  
Year 2008 \$11.11  
Annual Escalation 3.5%

**Epoxy-Urethane Sealer**  
Bridge Deck Joint Gland Replacement Cost per foot:  
Year 2004 \$59.50  
Year 2008 \$68.28  
Annual Escalation 3.5%

**Assume 25% of deck area requires removal to depth of 4.5" (3.25" additional removal):**  
Bridge Deck Joint Gland Replacement Cost per foot:  
Year 2004 \$59.50  
Year 2008 \$68.28  
Annual Escalation 3.5%

**Assume gland replacement cost equals 25% of original deck joint construction cost.**

Life Cycle Cost

**NOTES:**  
1. Life cycle maintenance costs assume a 75 -year structure life, and are expressed in present value (2008 construction year) dollars.  
2. Bridge Alt. 1 is assumed to have conventional abutments, therefore strip seal deck joints will be required.  
3. See Superstructure Cost sheet.  
4. See Alternative Cost Summary sheet.  
5. Assume bridge deck overlay at Year 25 and bridge deck replacement at Year 50. Assume superstructures are painted or sealed on a 25-year recurrence interval.  
6. Life cycle maintenance cost differences are assumed to be predominately a function of superstructure maintenance costs. Consequently, substructure lifecycle maintenance costs are not included in this analysis.

**Approach Pavement Resurfacing:**  
Resurface Perpetual Asphalt Pavement:  
Resurfacing Units Costs:  
Pavement Planing, Asphalt Concrete, per sq. vd. (Item 254)  
Year 2004 \$0.98  
Year 2008 \$1.12  
Annual Escalation 3.5%

Asphalt Concrete Surface Course, per cu. vd.  
Asphalt Resurfacing Costs:  
Approach Roadway Length (ft.) (4)  
Approach Roadway Width (ft.)  
Resurfacing Area (sq. vd.)  
Wearing Course Thickness (in.)  
Wearing Course Volume (cu. vd.)

Alt. 1 0.0 33.0 0 1.50 0.0  
Alt. 2 69.0 33.0 253 1.50 10.5  
Alt. 3 69.0 33.0 253 1.50 10.5

**APPENDIX B**

**Preferred Alternative Site Plan and Details**

**BENCHMARKS**

**CURVE DATA - RAMP B**  
 P.I. Sta = 2609+69.36  
 Δ = 102° 45' 15" (RT)  
 Dc = 11° 15' 00"  
 R = 509.30'  
 T = 637.46'  
 L = 913.37'  
 E = 306.63'

**TRAFFIC DATA**  
 CURRENT ADT (2010) = 2700  
 DESIGN ADT (2030) = 3600  
 DESIGN ADTT = 500

**LEGEND**  
 INDICATES BORING LOCATION

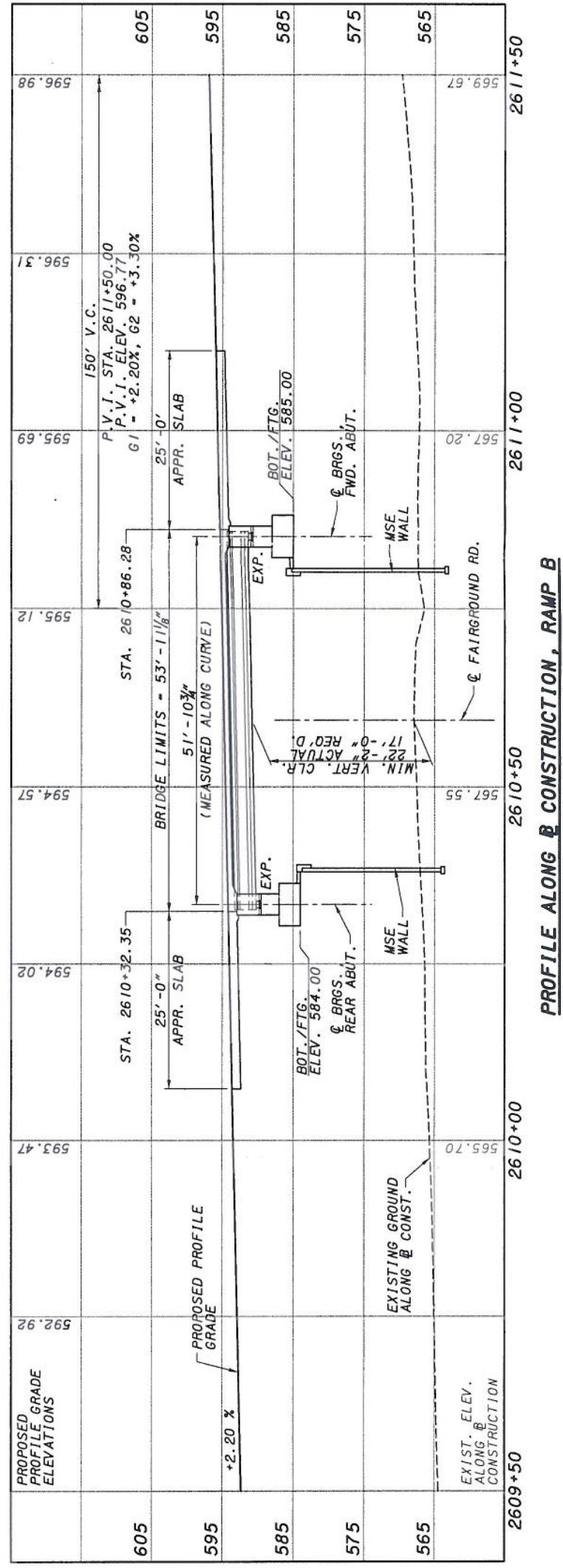
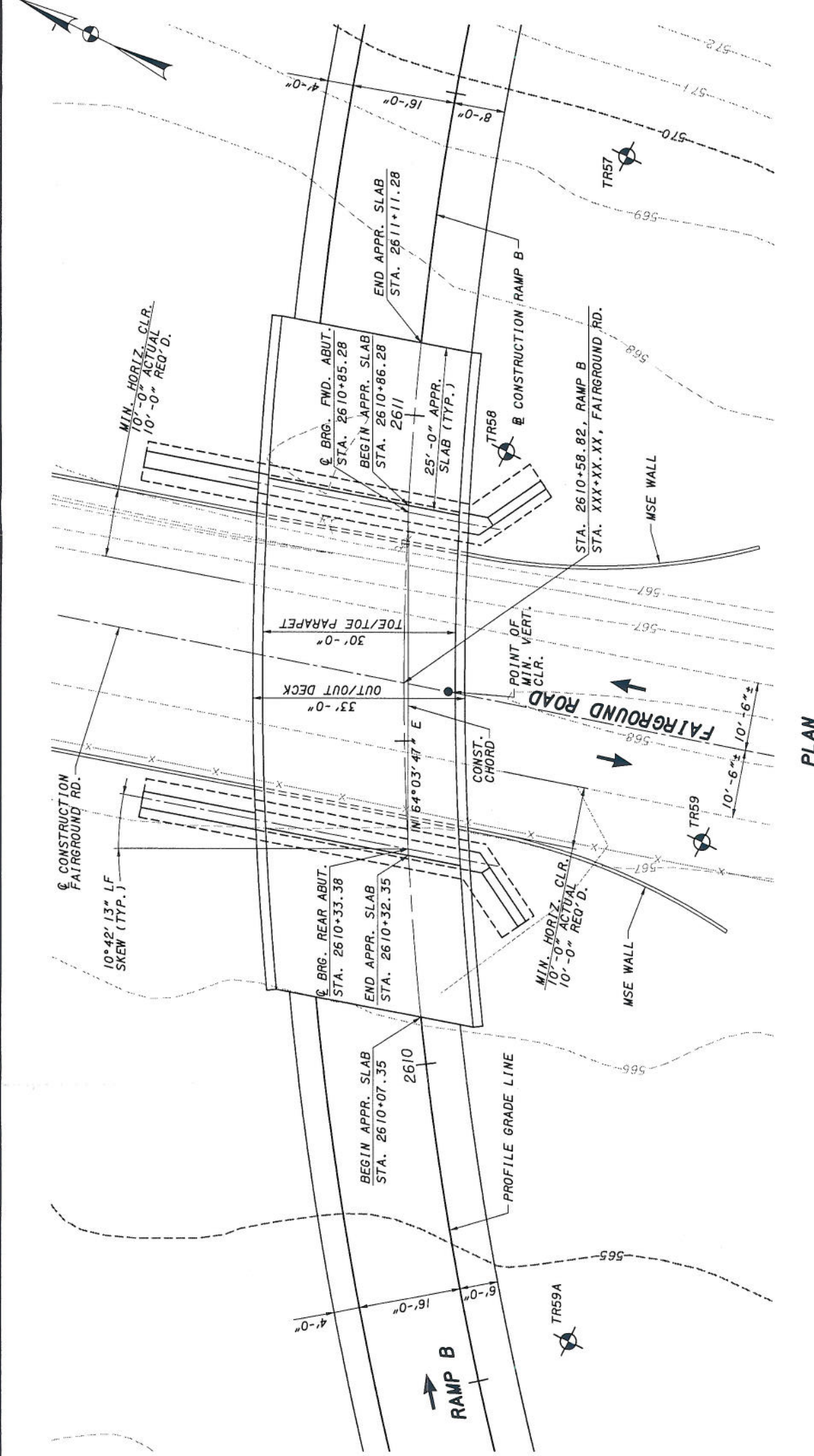

**NOTE**  
 EARTHWORK LIMITS SHOWN ARE APPROXIMATE. ACTUAL SLOPES SHALL CONFORM TO PLAN CROSS SECTIONS.

**PROPOSED STRUCTURE**  
 TYPE: SINGLE SPAN COMPOSITE PRESTRESSED CONCRETE I-BEAMS WITH REINFORCED CONCRETE DECK AND SEMI-INTEGRAL ABUTMENTS ON MSE WALLS  
 LENGTH OF SPAN: 51'-10 3/4", MEASURED ALONG RAMP CONSTRUCTION  
 ROADWAY: 30'-0" TOE/TOE PARAPETS  
 SIDEWALK: NONE  
 DESIGN LOADING: HS25 AND THE ALTERNATE MILITARY LOADING, FWS = 60 LB/FT<sup>2</sup>  
 SKEW: 10°42'13" LEFT FORWARD  
 WEARING SURFACE: MONOLITHIC CONCRETE  
 APPROACH SLABS: AS-1-81 (25'-0" LONG)  
 ALIGNMENT: HORIZONTALLY CURVED (RADIUS = 509.30')  
 CROWN: 0.083 FT/FT  
 LATITUDE: N 38°53'31"  
 LONGITUDE: W 82°59'51"

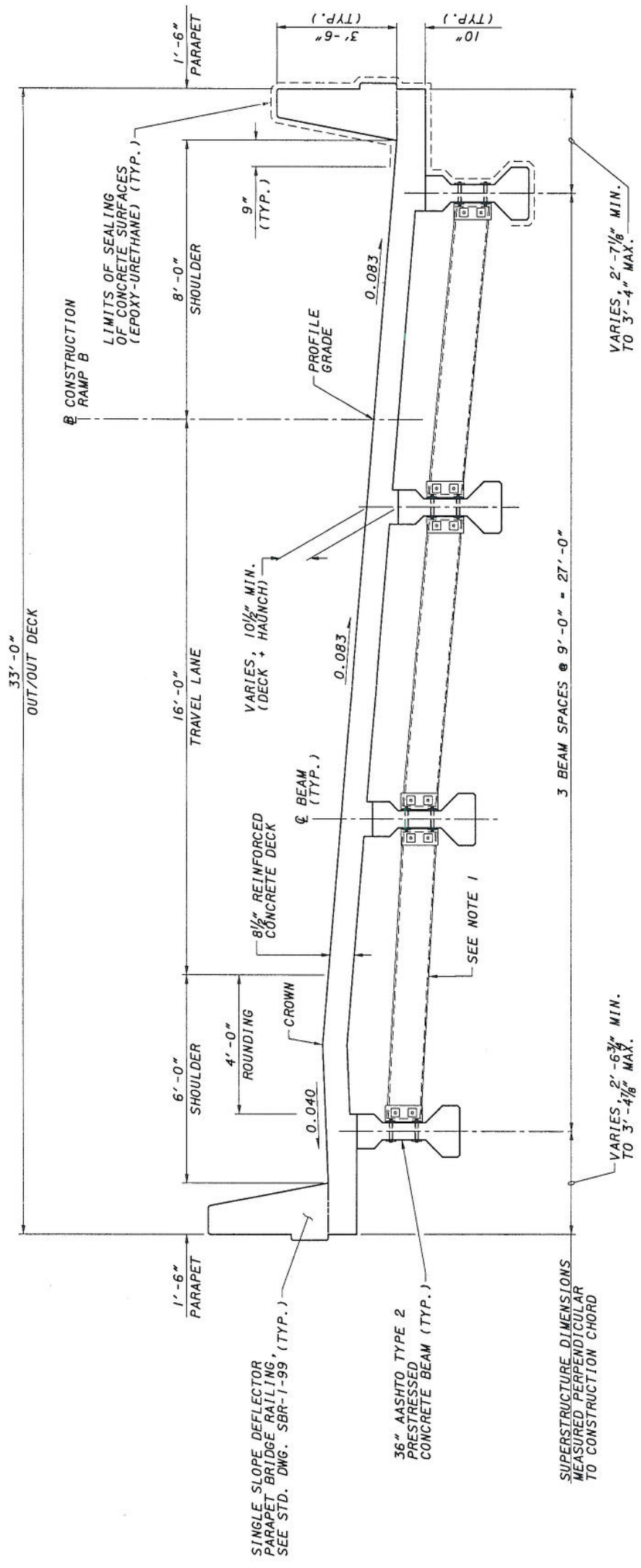

**TYPICAL TRANSVERSE SECTION**

- NOTES:**
- INTERMEDIATE DIAPHRAGMS MAY BE CAST-IN-PLACE CONCRETE OR GALVANIZED STEEL. FOR DETAILS OF BOTH DIAPHRAGM TYPES, SEE STANDARD CONSTRUCTION DRAWING PSID-1-99.



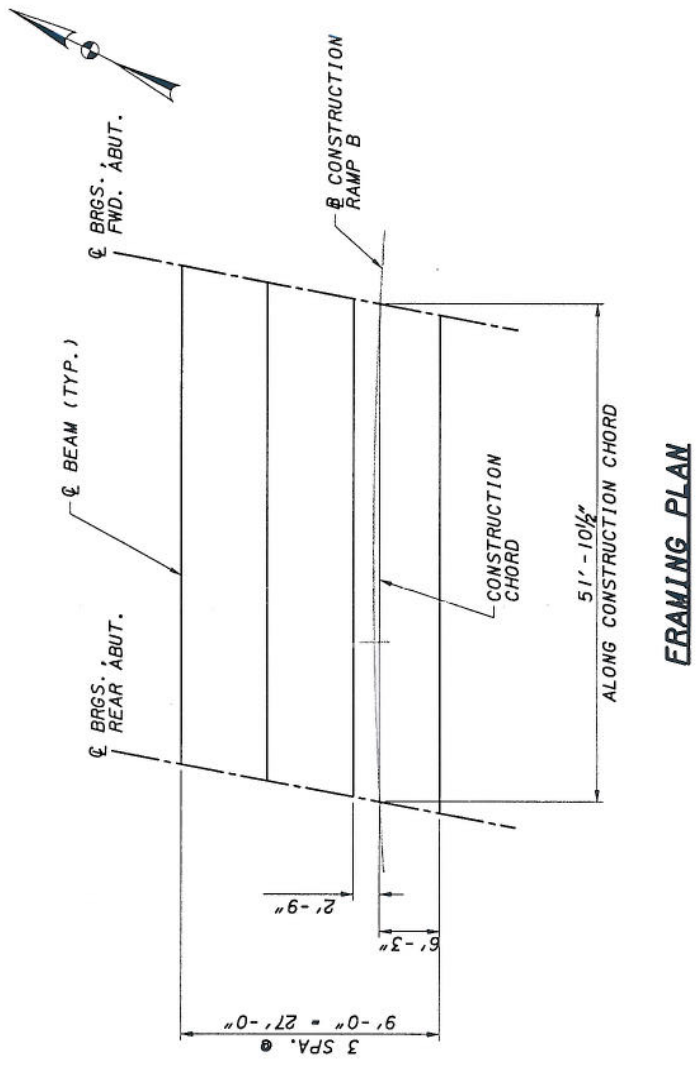

FRAMING PLAN

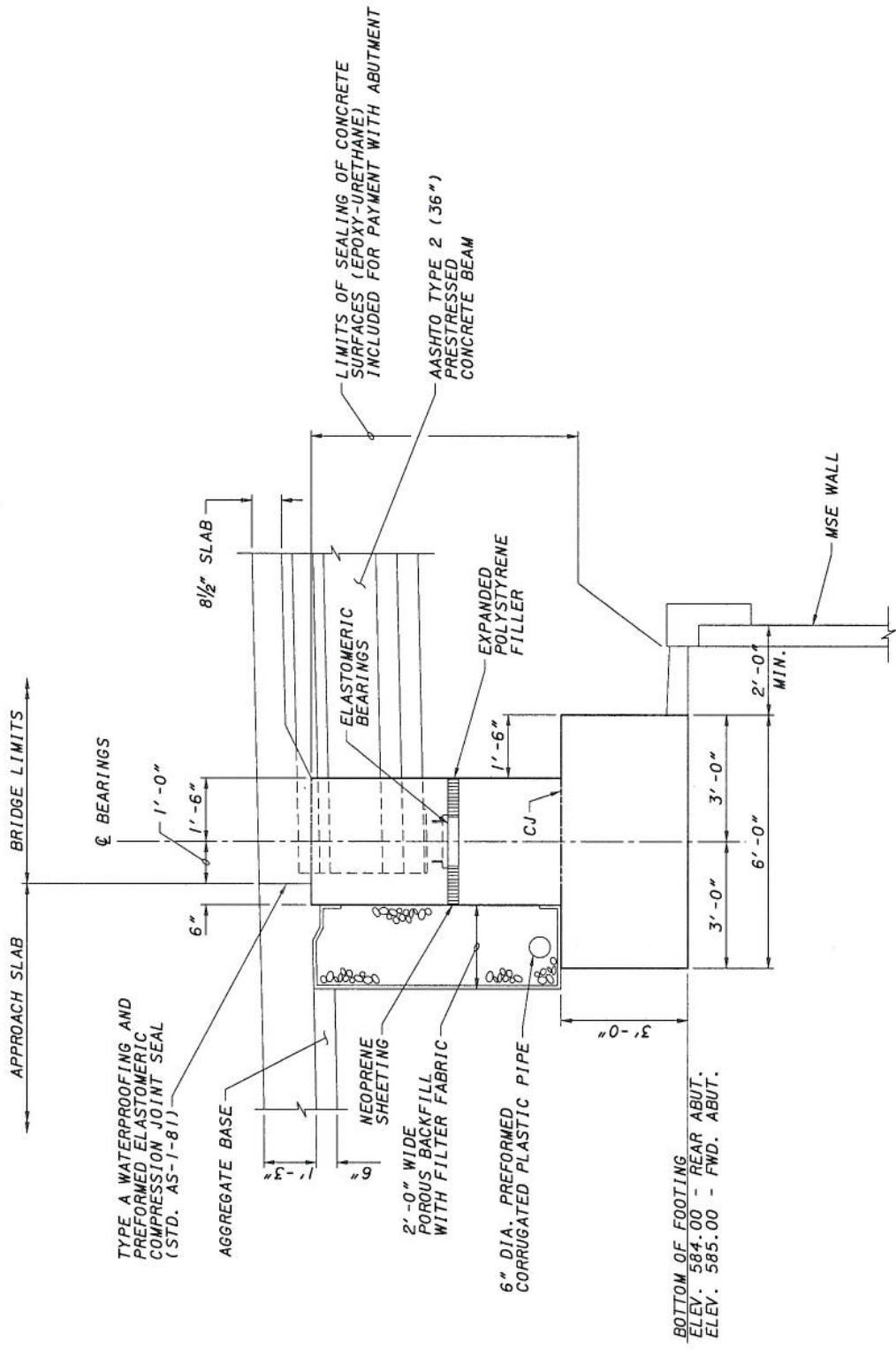

REAR AND FORWARD ABUTMENT SECTION

**APPENDIX C**

**Vertical Clearance Calculations**

**SCI-823-0.00**  
**RAMP B OVER FAIRGROUND ROAD**  
**VERTICAL CLEARANCES**

Filename: \\Aries\Proj\TranSystems\319861\19415\structures documents\Step 7 - Type Study\Bridge SCI823-1593C Ramp B over Fairground\{RampB\_Vert\_Clr.xls\Alternative 1  
 By: SKT Date: 07/06/2005  
 Checked: Date: **LEGEND:**  
 User Input - Not Critical  
 User Input - Critical to Output

**Alternative 1 - 48" Curved Steel Plate Girders**

**PROFILE DATA - Fairground Road**

Use existing pavement elevations as Fairground Road will not be reconstructed in this project

POINT	FAIRGROUND ROAD LOCATION	FAIRGROUND ROAD STATION	FAIRGROUND ROAD - EXISTING ELEV. @ POINT
1	E/Pavement SB	n/a	567.48
2	Centerline	n/a	568.01
3	E/Pavement NB	n/a	567.81

**PROFILE DATA - RAMP B**

Linear: PVT Sta. 2607+50.00 PVC Sta. 2610+75.00  
 PVT Elev. 587.97 PVC Elev. 595.12  
 g 2.20%

Vertical Curve: PVC Sta. 2610+75.00 PVI Sta. 2611+50.00 PVT Sta. 2612+25.00  
 PVI Elev. 595.12 PVI Elev. 596.77 PVT Elev. 599.24  
 g1 2.20%  
 g2 3.29%  
 LVC 150

Superelevation Data:

Station	Left Shoulder	Pavement	Right Shoulder
2604+16.91	-4.0%	8.3%	-8.3%
2611+81.33	-4.0%	8.3%	-8.3%

POINT	RAMP B LOCATION			RAMP B PG ELEV.	LT. SHOULDER X-SLOPE	PVMT X-SLOPE	RT. SHOULDER X-SLOPE	RAMP B - FINISHED GRADE @ POINT
	DESCRIPTION	STA.	OFF.*					
1	RT. FASCIA GIRDER	2610+46.90	6.50	594.50	-4.0%	8.3%	-8.3%	593.96
2	RT. FASCIA GIRDER	2610+57.95	6.50	594.74	-4.0%	8.3%	-8.3%	594.21
3	RT. FASCIA GIRDER	2610+68.29	6.50	594.97	-4.0%	8.3%	-8.3%	594.43

\* For Offsets allow positive (+) to denote an offset to the right of the baseline and negative (-) to denote an offset to the left of the baseline

**STRUCTURE DEPTH**

Haunch + Max. Top Flange = 3.0 in

POINT	GIRDER DESCRIPTION	Slab	Haunch	Top Flange	Web	Bot. Flange	Splice	Total
1	48" PLATE GIRDER	8.50	2.00	1.0	48	2.0	-	61.50 in
2	48" PLATE GIRDER	8.50	2.00	1.0	48	2.0	-	61.50 in
3	48" PLATE GIRDER	8.50	2.00	1.0	48	2.0	-	61.50 in

**VERTICAL CLEARANCE - RAMP B OVER FAIRGROUND RD.**

POINT	LOCATION	RAMP B - FINISHED GRADE @ POINT	STRUCTURE DEPTH (in.)	BOT. GIRDER ELEVATION	FAIRGROUND RD. - FINISHED GRADE @ POINT	VERTICAL CLEARANCE (ft.)
1	RT. FASCIA GIRDER	593.96	61.500	588.84	567.48	21.36
2	RT. FASCIA GIRDER	594.21	61.500	589.08	568.01	21.07
3	RT. FASCIA GIRDER	594.43	61.500	589.31	567.81	21.50

OK  
 OK  
 OK

**SCI-823-0.00**  
**RAMP B OVER FAIRGROUND ROAD**  
**VERTICAL CLEARANCES**

Filename: \\aries\proj\TranSystems\319861\19415\structures documents\Step 7 - Type Study\Bridge SCI823-1593C Ramp B over Fairground\{RampB\_Vert\_Clr.xls}Alternative 1  
 By: SKT Date: 07/06/2005  
 Checked: Date:            **LEGEND:**  
 User Input - Not Critical  
 User Input - Critical to Output

**Alternative 2 - AASHTO Type 2 Concrete I-Beams**

**PROFILE DATA - Fairground Road**

Use existing pavement elevations as Fairground Road will not be reconstructed in this project

POINT	FAIRGROUND ROAD LOCATION	FAIRGROUND ROAD STATION	FAIRGROUND ROAD - EXISTING ELEV. @ POINT
1	E/Pavement SB	n/a	567.48
2	Centerline	n/a	568.01
3	E/Pavement NB	n/a	567.81

**PROFILE DATA - RAMP B**

Linear: PVT Sta. 2607+50.00 PVC Sta. 2610+75.00  
 PVT Elev. 587.97 PVC Elev. 595.12  
 g 2.20%

Vertical Curve: PVC Sta. 2610+75.00 PVI Sta. 2611+50.00 PVT Sta. 2612+25.00  
 PVC Elev. 595.12 PVI Elev. 596.77 PVT Elev. 599.24  
 g1 2.20%  
 g2 3.29%  
 LVC 150

Superelevation Data:

Station	Left Shoulder	Pavement	Right Shoulder
2604+16.91	-4.0%	8.3%	-8.3%
2611+81.33	-4.0%	8.3%	-8.3%

POINT	RAMP B LOCATION			RAMP B PG ELEV.	LT. SHOULDER X-SLOPE	PVMT X-SLOPE	RT. SHOULDER X-SLOPE	RAMP B - FINISHED GRADE @ POINT
	DESCRIPTION	STA.	OFF.*					
1	RT. FASCIA BEAM	2610+46.84	6.76	594.50	-4.0%	8.3%	-8.3%	593.94
2	RT. FASCIA BEAM	2610+57.87	6.91	594.74	-4.0%	8.3%	-8.3%	594.17
3	RT. FASCIA BEAM	2610+68.24	6.83	594.97	-4.0%	8.3%	-8.3%	594.40

\* For Offsets allow positive (+) to denote an offset to the right of the baseline and negative (-) to denote an offset to the left of the baseline

**STRUCTURE DEPTH**

Haunch + Max. Top Flange = 3.0 in

POINT	BEAM DESCRIPTION	Slab	Haunch	Top Flange	Web	Bot. Flange	Splice	Total
1	AASHTO Type 2	8.50	3.00	0.0	36	0.0	-	47.50 in
2	AASHTO Type 2	8.50	3.00	0.0	36	0.0	-	47.50 in
3	AASHTO Type 2	8.50	3.00	0.0	36	0.0	-	47.50 in

**VERTICAL CLEARANCE - RAMP B OVER FAIRGROUND RD.**

POINT	LOCATION	RAMP B - FINISHED GRADE @ POINT	STRUCTURE DEPTH (in.)	BOT. BEAM ELEVATION	FAIRGROUND RD. - FINISHED GRADE @ POINT	VERTICAL CLEARANCE (ft.)
1	RT. FASCIA BEAM	593.94	47.500	589.98	567.48	22.50
2	RT. FASCIA BEAM	594.17	47.500	590.21	568.01	22.20
3	RT. FASCIA BEAM	594.40	47.500	590.45	567.81	22.64

OK  
OK  
OK

**SCI-823-0.00**  
**RAMP B OVER FAIRGROUND ROAD**  
**VERTICAL CLEARANCES**

Filename: \\Aries\Proj\TranSystems\319861\19415\structures documents\Step 7 - Type Study\Bridge SCI823-1593C Ramp B over Fairground\{RampB\_Vert\_Clr.xls}Alternative 1  
 By: SKT Date: 07/06/2005  
 Checked: Date: **LEGEND:**  
 User Input - Not Critical  
 User Input - Critical to Output

**Alternative 3 - W24 Steel Rolled Beams**

**PROFILE DATA - Fairground Road**

Use existing pavement elevations as Fairground Road will not be reconstructed in this project

POINT	FAIRGROUND ROAD LOCATION	FAIRGROUND ROAD STATION	FAIRGROUND ROAD - EXISTING ELEV. @ POINT
1	E/Pavement SB	n/a	567.48
2	Centerline	n/a	568.01
3	E/Pavement NB	n/a	567.81

**PROFILE DATA - RAMP B**

Linear: PVT Sta. 2607+50.00 PVC Sta. 2610+75.00  
 PVT Elev. 587.97 PVC Elev. 595.12  
 g 2.20%

Vertical Curve: PVC Sta. 2610+75.00 PVI Sta. 2611+50.00 PVT Sta. 2612+25.00  
 PVI Elev. 595.12 PVI Elev. 596.77 PVT Elev. 599.24  
 g1 2.20%  
 g2 3.29%  
 LVC 150

Superelevation Data:

Station	Left Shoulder	Pavement	Right Shoulder
2604+16.91	-4.0%	8.3%	-8.3%
2611+81.33	-4.0%	8.3%	-8.3%

POINT	RAMP B LOCATION			RAMP B PG ELEV.	LT. SHOULDER X-SLOPE	PVMT X-SLOPE	RT. SHOULDER X-SLOPE	RAMP B - FINISHED GRADE @ POINT
	DESCRIPTION	STA.	OFF.					
1	RT. FASCIA BEAM	2610+46.84	6.76	594.50	-4.0%	8.3%	-8.3%	593.94
2	RT. FASCIA BEAM	2610+57.87	6.91	594.74	-4.0%	8.3%	-8.3%	594.17
3	RT. FASCIA BEAM	2610+68.24	6.83	594.97	-4.0%	8.3%	-8.3%	594.40

\* For Offsets allow positive (+) to denote an offset to the right of the baseline and negative (-) to denote an offset to the left of the baseline

**STRUCTURE DEPTH**

Haunch + Max. Top Flange = 3.0 in

POINT	BEAM DESCRIPTION	Slab	Haunch	Top Flange	Web	Bot. Flange	Splice	Total
1	W24 Rolled Beam	8.50	2.00	1.0	22	1.0	-	34.50 in
2	W24 Rolled Beam	8.50	2.00	1.0	22	1.0	-	34.50 in
3	W24 Rolled Beam	8.50	2.00	1.0	22	1.0	-	34.50 in

**VERTICAL CLEARANCE - RAMP B OVER FAIRGROUND RD.**

POINT	LOCATION	RAMP B - FINISHED GRADE @ POINT	STRUCTURE DEPTH (in.)	BOT. BEAM ELEVATION	FAIRGROUND RD. - FINISHED GRADE @ POINT	VERTICAL CLEARANCE (ft.)
1	RT. FASCIA BEAM	593.94	34.500	591.06	567.48	23.58
2	RT. FASCIA BEAM	594.17	34.500	591.29	568.01	23.28
3	RT. FASCIA BEAM	594.40	34.500	591.53	567.81	23.72

OK  
 OK  
 OK

**APPENDIX D**

**Preliminary Structure Site Plans**



SCI-823-0.00

SITE PLAN

DESIGNED	SKT	DESIGNED	SKT	DESIGNED	SKT	DESIGNED	SKT	DESIGNED	SKT	DESIGNED	SKT
REVIEWED	MME	REVIEWED	MME	REVIEWED	MME	REVIEWED	MME	REVIEWED	MME	REVIEWED	MME
DATE	GAS	DATE	GAS	DATE	GAS	DATE	GAS	DATE	GAS	DATE	GAS
06/05	06/05	06/05	06/05	06/05	06/05	06/05	06/05	06/05	06/05	06/05	06/05
STRUCTURE FILE NUMBER			STRUCTURE FILE NUMBER			STRUCTURE FILE NUMBER			STRUCTURE FILE NUMBER		
5775 Perimeter Drive, Suite 190			5775 Perimeter Drive, Suite 190			5775 Perimeter Drive, Suite 190			5775 Perimeter Drive, Suite 190		
CH2MHILL			CH2MHILL			CH2MHILL			CH2MHILL		
DESIGN AGENCY			DESIGN AGENCY			DESIGN AGENCY			DESIGN AGENCY		

BRIDGE NO. SCI-823-1593  
 RAMP B OVER FAIRGROUND ROAD - ALT. 1  
 TO STA. 2611+25.86  
 SCIO TO COUNTY

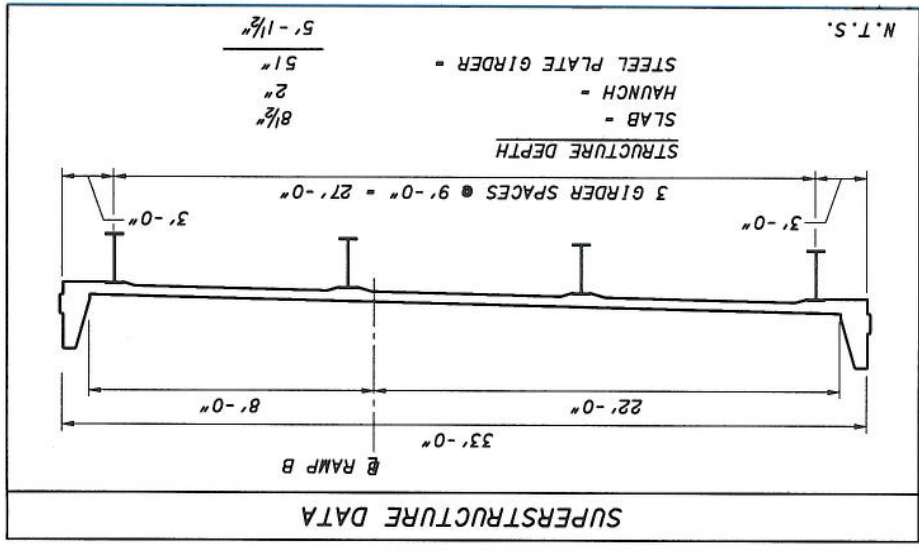

PROPOSED STRUCTURE

TYPE: SINGLE SPAN COMPOSITE CURVED STEEL PLATE GIRDERS (PAINTED ASTM A709, GR 50) WITH REINFORCED CONCRETE DECK ON JOINTED STUB ABUTMENTS

LENGTH OF SPAN:

ROADWAY:

SIDEWALK:

DESIGN LOADING:

SKREW:

WEARING SURFACE:

APPROACH SLABS:

ALIGNMENT:

CROWN:

LATITUDE:

LONGITUDE:

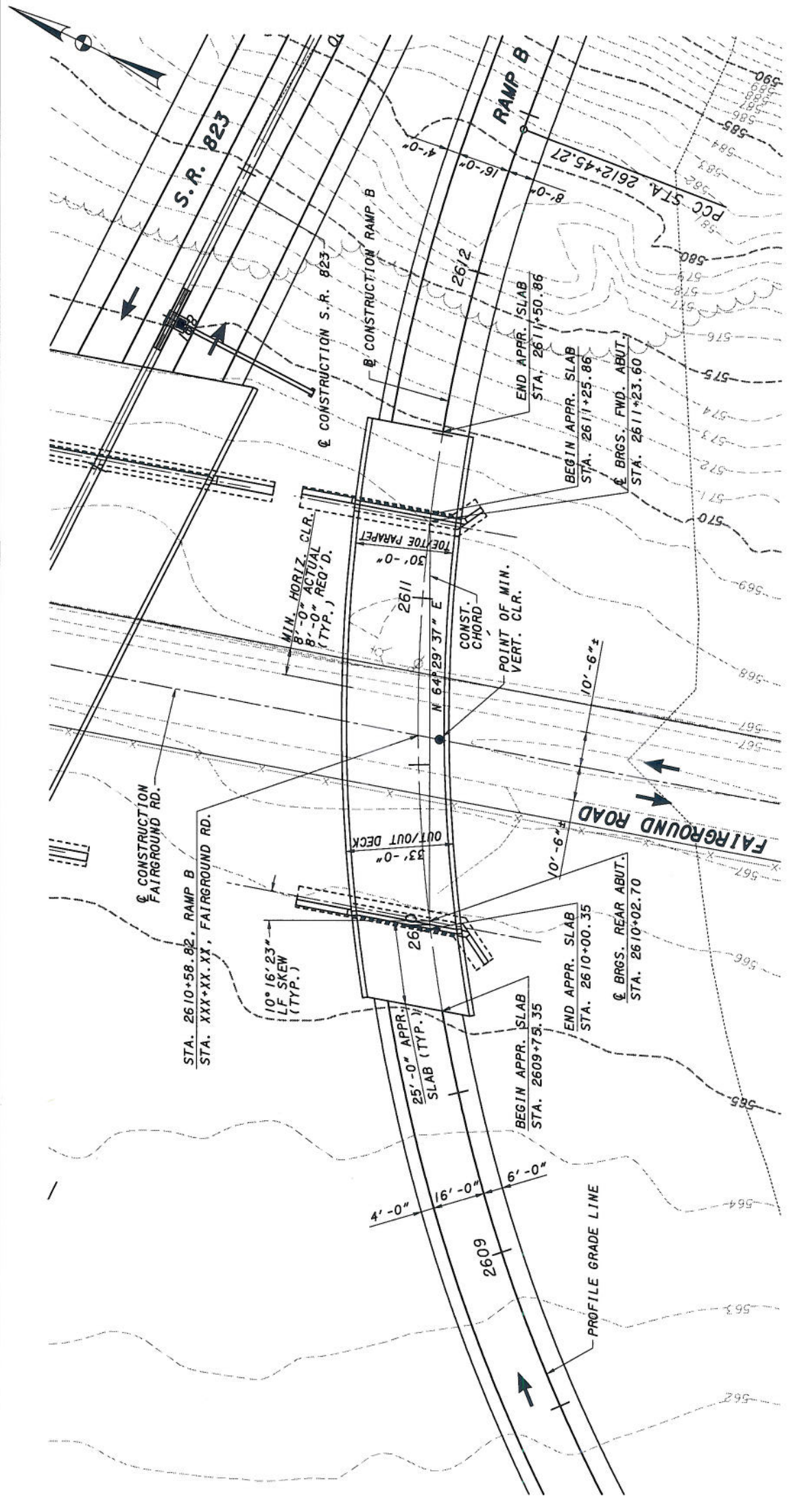

PLAN

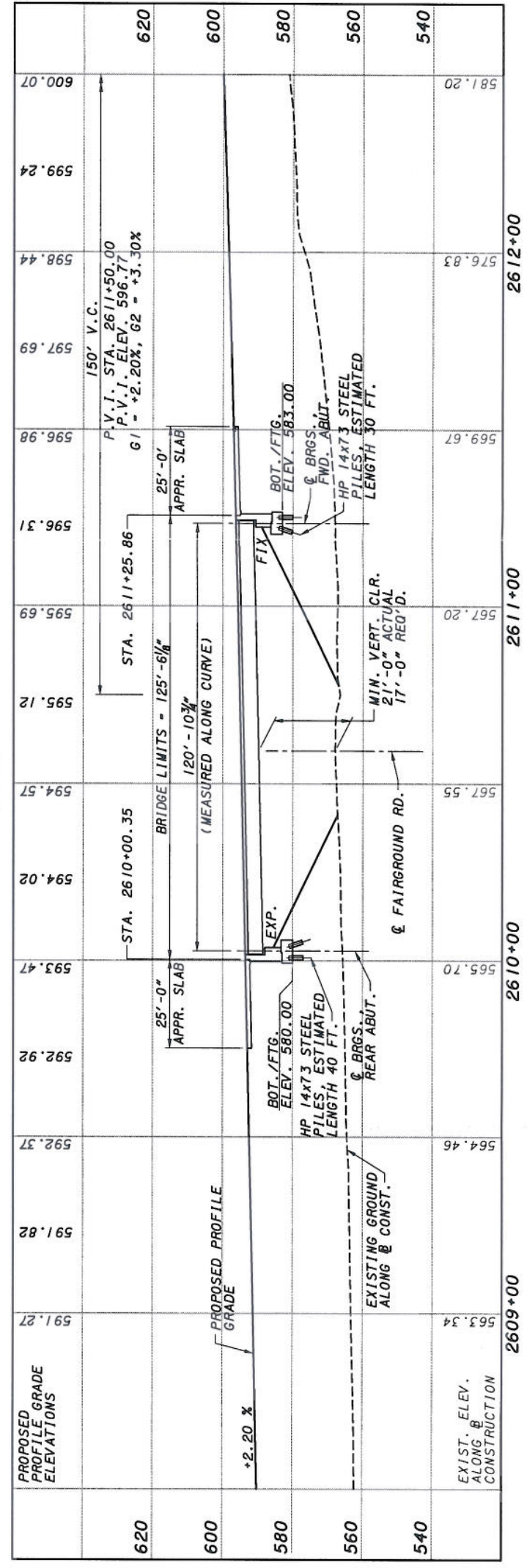

PROFILE ALONG B CONSTRUCTION, RAMP B



SCI-823-0.00

S I T E P L A N

BRIDGE NO. SCI-823-1593  
 RAMP B OVER FAIRGROUND ROAD - ALT. 3  
 TO STA. 2610+86.28  
 STA. 2610+32.35  
 SCIOTO COUNTY

DESIGNED SKT  
 CHECKED DGS  
 REVISIONS  
 DATE 06/05  
 GAS  
 STRUCTURE FILE NUMBER

DESIGN AGENCY  
**CH2MHILL**  
 5775 Perimeter Drive, Suite 190  
 Dublin, Ohio 43017

**PROPOSED STRUCTURE**

**TYPE:** SINGLE SPAN COMPOSITE STEEL ROLLED BEAMS (PAINTED ASTM A709, GR 50) WITH REINFORCED CONCRETE DECK AND SEMI-INTEGRAL ABUTMENTS ON MSE WALLS

**LENGTH OF SPAN:**

**ROADWAY:**

**SIDEWALK:**

**DESIGN LOADING:**

**SKEW:**

**WEARING SURFACE:**

**APPROACH SLABS:**

**ALIGNMENT:**

**CROWN:**

**LATITUDE:**

**LONGITUDE:**

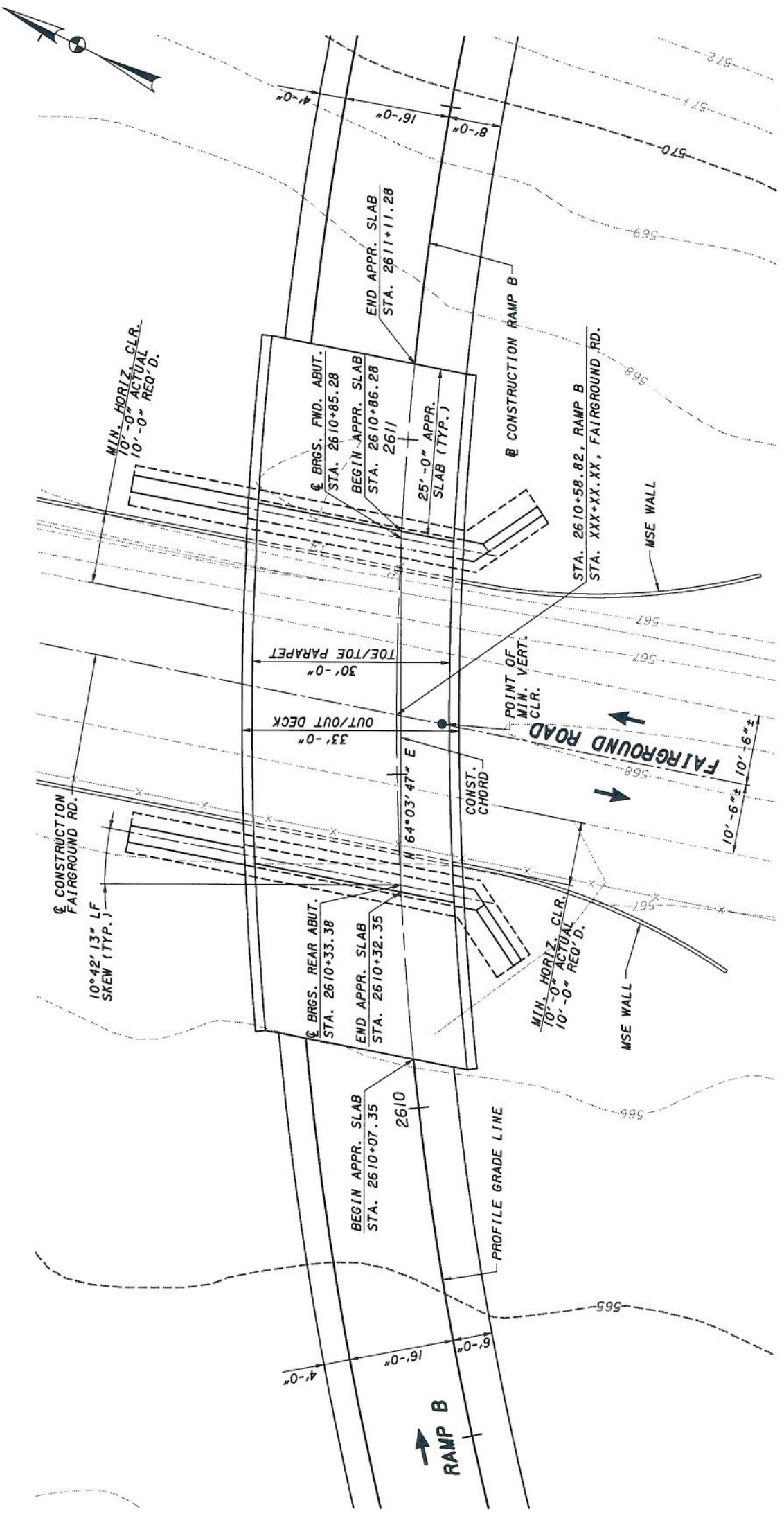
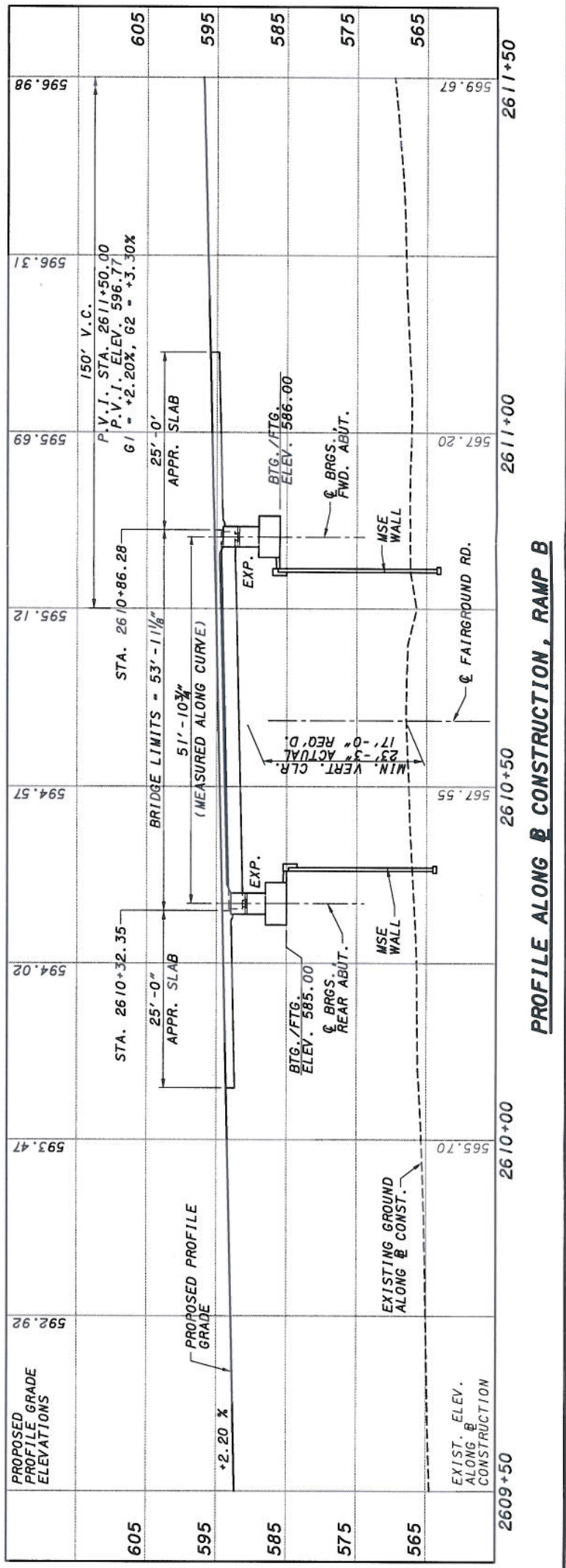
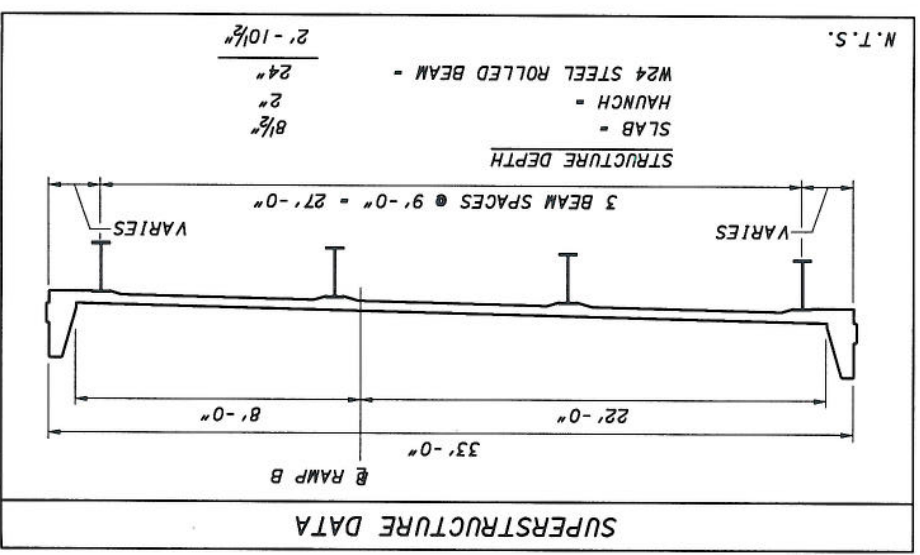



APPENDIX E

Preliminary Foundation Recommendations



May 2, 2005

Mr. Greg Parsons, P.E.  
Project Manager  
TranSystems Corporation  
5747 Perimeter Dr., Suite 240  
Dublin, OH 43017

**Re: US 23 and SCI-823-0.00 Interchange  
Preliminary Structural Foundation Recommendations  
Project SCI-823-0.00  
DLZ Job No.: 0121-3070.03**

Dear Mr. Parsons:

This letter reports the findings of the subsurface exploration and preliminary foundation recommendations for the proposed structures at the US 23 and SCI-823-0.00 interchange to be located north of Lucasville, Ohio within the area of the Scioto County Fairgrounds. It is anticipated that six proposed bridges, and MSE walls along Ramps B and C, will be constructed as part of the interchange.

It is our understanding that the western portion of the interchange, Ramp A and Ramp D, will be constructed through earthwork and no structures will be constructed. The existing grade across the proposed interchange location is relatively flat with an elevation range between 530 and 570. Currently, the area has roadways for US 23 and Fairground Road (CR 55) as well as two sets of railroad tracks maintained by CSX Railroad. The area to the west of US 23 is primarily agricultural. It is anticipated that the SCI-823-0.00 mainline and majority of the interchange will require embankment construction with Ramps B and C requiring mostly mechanically stabilized earth (MSE) wall construction. At this time the embankment heights are unknown, however it is anticipated that as much as 50 feet of fill may be required in some areas of embankment and up to 25 feet of fill in areas of MSE wall construction.

The existing area of the proposed interchange is located within the Scioto River valley with the overburden being primarily composed of glacial and alluvial deposits. The following table briefly outlines the anticipated structures, and the attached plan indicated the location of the structures in proximity to existing features.

Mr. Greg Parsons, P.E.  
May 2, 2005  
Page 2

US 23 – SCI 823 Interchange Structures

Proposed Structure*	Approximate Location	Anticipated Number of Spans	Existing Grade Elevation**	Borings
Mainline Overpass #1	SCI-823 over Fairgrounds Rd	1	565 – 570	TR-55A, TR-56
Mainline Overpass #2	SCI-823 over US 23 & CSX RR.	3	533 – 555	TR-49A, TR-50A, TR-51, TR-52
Ramp B - #1	US 23 NB to SCI-823 over CSX RR	1	546 – 540	TR-60, TR-61
Ramp B - #2	US 23 NB to SCI-823 over Fairgrounds Rd.	2	564 – 570	TR-57, TR-58, TR-59A
Ramp C - #1	SCI-823 to US 23 NB over Fairgrounds Rd	1	565 – 568	TR-53A, TR-54
Ramp C - #2	SCI-823 to US 23 NB over CSX RR	2	543 – 550	TR-46, TR-47, TR-48

\* As indicated on the attached plan.

\*\* Established from established project topographic mapping.

The findings and recommendations presented in this report should be considered preliminary. It is understood that the final number and locations of substructure units have not been determined yet. After the substructure unit locations have been established, the results of the borings should be reviewed to determine if additional exploration is needed to finalize the foundation recommendations for the new structure.

### Field Exploration

A total of sixteen structure borings, TR-46 through TR-48, TR-49A through TR-50A, TR-51, TR-52, TR-53, TR54A, TR-55A, TR-56 through TR-58, TR-59A, TR-60 and TR-61, were drilled at the proposed structures between March 14 and March 21, 2005. It should be noted that

Mr. Greg Parsons, P.E.

May 2, 2005

Page 3

five borings (TR-49, TR-50, TR-53, TR-55, and TR-59) were drilled during 2004, and were not used to prepare these preliminary foundation recommendations. These boring locations were moved due to an adjustment in the project coordinate system. The structure borings were drilled to depths between 25 and 45 feet below the ground surface. The borings were extended into bedrock, which was verified by rock coring. Boring Logs and information concerning the drilling procedures are attached.

The boring locations were selected by TranSystems Corporation. Ground surface elevations at the boring locations were estimated from the established topographic mapping for the project and are presented on the attached Boring Logs.

### **Findings**

The following text presents generalized subsurface conditions encountered by the borings. For a brief discussion of the subsurface conditions at each structure refer to the Conclusions and Recommendations section, or for more detailed information, please refer to the attached Boring Logs.

At the ground surface, topsoil was encountered to depths of 1 to 7 inches. Beneath the topsoil, subsurface materials encountered generally were interbedded granular and cohesive layers. The cohesive soils encountered ranged from sandy silt (A-4a) to silt and clay (A-6b), and ranged in consistency from medium stiff to very stiff. The granular soils encountered ranged from sandy silt (A-4a) to gravel with sand (A-1-b), and ranged in compactness from very loose to very dense. Natural moisture of the cohesive were generally damp to moist, and the granular layers were damp to wet.

Bedrock was encountered in all of the borings ranging in depth from 13.6 to 33.5 feet below the ground surface. The bedrock encountered was either shale that was very soft or soft, siltstone that was medium hard, or sandstone that was medium hard or hard, which was sometimes interbedded with the siltstone. Recovery of the core samples ranged from 70 to 100%, and RQD values ranged from 13 to 92% with an average RQD of 88%.

Seepage was detected in the majority of the borings ranging in depth from 13 to 30 feet below the ground surface. Seepage was generally detected within granular layers. No seepage was detected in Borings TR-53A, TR-54, and TR-56 through TR-58. Water levels recorded prior to coring ranged from dry to 26 feet below the ground surface, and at completion of drilling ranged from 3.5 to 19.0 feet below the ground surface. However, the final water levels include drilling water and may not be representative of the actual groundwater conditions. Groundwater levels may vary seasonally and will most likely be influenced by the Scioto River.

Mr. Greg Parsons, P.E.  
May 2, 2005  
Page 4

## **Conclusions and Recommendations**

It appears that driven H-piles or drilled shafts on bedrock will be the best-suited foundation types for the support of the proposed structures. If high lateral or uplift loads are anticipated drilled shafts extending into bedrock may be needed. The actual design lengths, or rock sockets, will need to be designed based upon actual loading conditions. Spread footing foundations were evaluated for support of the structures. At the abutment locations, spread footing recommendations are based upon the assumption that the embankment fill will be properly placed and compacted in accordance with CMS Item 203: Roadway Excavation and Embankment. The following is a brief discussion of each structure.

### **Mainline Overpass - #1**

Overpass #1 will be SCI-823-0.00 over Fairgrounds Road. Borings TR-55A, and TR-56 were drilled for this structure. Generally, these borings encountered cohesive soils at the ground surface consisting of silt and clay (A-6a), and silty clay (A-6b). These cohesive soils extended between 8.0 and 13.0 feet below the ground surface. Granular soils are located underlying the cohesive soils consisting of sandy silt (A-4a) and coarse and fine sand (A-3a). Bedrock was encountered at depths of 14.1 and 18.0 feet below the ground surface.

Due to the size of the structure, if H-piles are used, it is recommended that HP 14X73 H-pile sections, with a 95-ton capacity, be considered. H-piles should be driven to refusal to the top of bedrock. H-piles driven to refusal may be designed based on the full allowable capacity of the pile. An alternative to driven H-piles would be the use of drilled shafts extending to bedrock. It is anticipated that at the abutments, significant amounts of fill will be placed and spread footings within the embankment fills may be considered. It does not appear reasonable that spread footings extending to bedrock could be used at the abutments. The following table summarizes the site conditions and preliminary foundation recommendations.

Mr. Greg Parsons, P.E.  
May 2, 2005  
Page 5

Foundation Recommendations – Mainline Overpass - #1

Boring Number	Structural Element	Existing Ground Surface Elevation* (Feet)	Top of Rock Elevation* (Feet)	Estimated Drilled Shaft Tip Elevation* (Feet)	Allowable Bearing Capacity for Drilled Shafts (TSF)	Allowable Bearing Capacity for Spread Footings (TSF)**
TR-55A	Forward Abutment	565.5	547.5	543	15	1.5
TR-56	Rear Abutment	569.5	555.4	552	15	1.5

\*Existing ground surface elevation was estimated from the established topographic mapping.

\*\*Assuming spread footings founded on embankment fill.

**Mainline Overpass - #2**

Overpass #2 will SCI-823-0.00 over US 23 and CSX Railroad. Borings TR-49A through TR-52 were drilled for this structure. Topsoil was encountered at the ground surface ranging in depth between 1 and 2 inches, except at TR-49A, which did not encounter any topsoil. TR-50A encountered fill beneath the topsoil to a depth of 3.0 feet. Generally, beneath the topsoil the borings encountered cohesive soils at the ground surface consisting of silt and clay (A-6a), and silty clay (A-6b). ranging in consistency from stiff to hard. These cohesive soils extended between 8.0 and 20.5 feet below the ground surface. Granular soils are located underlying the cohesive soils ranging from sandy silt (A-4a) to gravel with sand (A-1-b). The granular soils were very loose to medium dense in compactness, with the majority of the layers being very loose of loose. Bedrock was encountered between depths of 24.5 and 33.5 feet below the ground surface. The bedrock encountered was shale and sandstone.

Due to the size of the structure, if H-piles are used, it is recommended that HP 14X73 H-pile sections, with a 95-ton capacity, be considered. H-piles should be driven to refusal to the top of bedrock. H-piles driven to refusal may be designed based on the full allowable capacity of the pile. An alternative to driven H-piles would be the use of drilled shafts extending to bedrock. It is anticipated that at the abutments, significant amounts of fill will be placed and spread footings within the embankment fills may be considered. It does not appear that spread footings extending to bedrock could be used at the abutment or pier locations. The following table summarizes the site conditions and preliminary foundation recommendations.

Mr. Greg Parsons, P.E.  
May 2, 2005  
Page 6

Foundation Recommendations – Mainline Overpass - #2

Boring Number	Structural Element	Existing Ground Surface Elevation* (Feet)	Top of Rock Elevation* (Feet)	Estimated Drilled Shaft Tip Elevation* (Feet)	Allowable Bearing Capacity for Drilled Shafts (TSF)	Allowable Bearing Capacity for Spread Footings (TSF)**
TR-49A	Forward Abutment	537.5	505.5	502	20	1.5
TR-50A	Pier 2	540.0	515.5	510	20	NA
TR-51	Pier 1	545.0	519.5	514	20	NA
TR-52	Rear Abutment	558.0	524.5	521	15	1.5

\*Existing ground surface elevation was estimated from the established topographic mapping.

\*\*Assuming spread footings founded on embankment fill.

**Ramp B - #1**

Ramp B-#1 will from US 23 northbound (NB) to SCI-823-0.00 over the CSX railroad. Borings TR-60 and TR-61 were drilled for this structure. A sandy silt (A-4a) fill was encountered at the ground surface in each boring and extended to depths of 3.0 and 5.5 feet below the ground surface. Beneath the fill, Boring TR-60 generally encountered granular soil ranging from sandy silt to coarse and fine sand (A-3a) in very loose to loose compactness to the top of rock at 28.0 feet. Boring TR-61 encountered a very stiff silt and clay (A-6a) to 10.5 feet, which was underlain by a very loose coarse to fine sand (A-3a). Bedrock was encountered at 23 feet below the ground surface. Bedrock encountered in borings was shale.

Due to the size of the structure, if H-piles are used, it is recommended that HP 14X73 H-pile sections, with a 95-ton capacity, be considered. H-piles should be driven to refusal to the top of bedrock. H-piles driven to refusal may be designed based on the full allowable capacity of the pile. An alternative to driven H-piles would be the use of drilled shafts extending bedrock. It does not appear reasonable that spread footings extending to bedrock could be used at either abutment due to the depth to bedrock. However, it is anticipated that at the abutments, significant amounts of fill will be placed and spread footings within the embankment fills may be considered. The following table summarizes the site conditions and preliminary foundation recommendations.

Mr. Greg Parsons, P.E.  
May 2, 2005  
Page 7

Foundation Recommendations – Ramp B - #1

Boring Number	Structural Element	Existing Ground Surface Elevation* (Feet)	Top of Rock Elevation* (Feet)	Estimated Drilled Shaft Tip Elevation* (Feet)	Allowable Bearing Capacity for Drilled Shafts (TSF)	Allowable Bearing Capacity for Spread Footings (TSF)**
TR-60	Forward Abutment	554	526	522	15	1.5
TR-61	Rear Abutment	547	524	520	15	1.5

\*Existing ground surface elevation was estimated from the established topographic mapping.

\*\*Assuming spread footings founded on embankment fill.

**Ramp B - #2**

Ramp B-#2 will be from US 23 northbound (NB) to SCI-823-0.00 over Fairground Road. Borings TR-57 through TR-59A were drilled for this structure. Borings TR-57 and TR-58 encountered cohesive soils at the ground surface consisting silt and clay (A-6a) ranging in consistency from stiff to hard. These cohesive soils extended between 14.0 and 8.0 feet below the ground surface, respectively. Granular soils are located underlying the cohesive soils, and at the ground surface at TR-59A, consisting of sandy silt (A-4a) and coarse and fine sand (A-3a). Generally, the granular soils were very loose to medium dense in compactness. Bedrock was encountered between depths of 14.0 and 21.5 feet below the ground surface.

Due to the size of the structure, if H-piles are used, it is recommended that HP 14X73 H-pile sections, with a 95-ton capacity, be considered. H-piles should be driven to refusal to the top of bedrock. H-piles driven to refusal may be designed based on the full allowable capacity of the pile. An alternative to driven H-piles would be the use of drilled shafts extending to bedrock. Spread footings founded on bedrock can be considered at the pier location, if no significant amounts of fill are to be placed. It is anticipated that at the abutments, significant amounts of fill will be placed and spread footings within the embankment fills may be considered. It does not appear reasonable that spread footings extending to bedrock could be used at the abutments. The following table summarizes the site conditions and preliminary foundation recommendations.



Mr. Greg Parsons, P.E.  
May 2, 2005  
Page 8

Foundation Recommendations – Ramp B - #2

Boring Number	Structural Element	Existing Ground Surface Elevation* (Feet)	Top of Rock Elevation* (Feet)	Estimated Drilled Shaft Tip Elevation*	Allowable Bearing Capacity for Drilled Shafts (TSF)	Estimated Spread Footing Elevation*	Allowable Bearing Capacity for Spread Footings (TSF)
TR-57	Forward Abutment	569.5	555.5	552	15	Unknown	1.5**
TR-58	Pier	567.0	553.0	549	15	551.0	12
TR-59A	Rear Abutment	564.5	543.0	538	15	Unknown	1.5**

\*Existing ground surface elevation was estimated from the established topographic mapping.  
The Embankment heights at the abutment locations is not know at this time.

\*\*Assuming spread footings founded on embankment fill.

**Ramp C - #1**

Ramp C-#1 is from SCI-823-00 northbound (NB) to US 23 NB over Fairground Road. Borings TR-53A and TR-54 were drilled for this structure. Generally, these borings encountered cohesive soils at the ground surface consisting of sandy silt (A-4a) and silt and clay (A-6a) ranging in consistency from stiff to hard. These cohesive soils extended between 5.5 and 10.5 feet below the ground surface. Coarse and fine sand (A-3a) granular soils are located underlying the cohesive soils, which range from very loose to loose in compactness. Shale bedrock was encountered at depths of 13.6 and 20.5 feet below the ground surface.

Due to the size of the structure, if H-piles are used, it is recommended that HP 14X73 H-pile sections, with a 95-ton capacity, be recommended. H-piles should be driven to refusal to the top of bedrock. H-piles driven to refusal may be designed based on the full allowable capacity of the pile. An alternative to driven H-piles would be the use of drilled shafts extending to bedrock. It is anticipated that at the abutments, significant amounts of fill will be placed and spread footings within the embankment fills may be considered. It does not appear reasonable that spread footings extending to bedrock could be used at the abutments due to the depth to bedrock. The following table summarizes the site conditions and preliminary foundation recommendations.

Mr. Greg Parsons, P.E.  
May 2, 2005  
Page 9

Foundation Recommendations – Ramp C - #1

Boring Number	Structural Element	Existing Ground Surface Elevation* (Feet)	Top of Rock Elevation* (Feet)	Estimated Drilled Shaft Tip Elevation*	Allowable Bearing Capacity for Drilled Shafts (TSF)	Allowable Bearing Capacity for Spread Footings (TSF)**
TR-53A	Forward Abutment	565.5	545.0	541	15	1.5
TR-54	Rear Abutment	567.5	553.9	550	15	1.5

\*Existing ground surface elevation was estimated from the established topographic mapping.

\*\*Assuming spread footings founded on embankment fill.

**Ramp C - #2**

Ramp C-#2 will be from SCI-823-0.00 northbound (NB) to US 23 NB over the CSX railroad. Borings TR-46 through TR-48 were drilled for this structure. Generally, these borings encountered inter-layered cohesive soils and granular soils. Cohesive layers encountered consisted of sandy silt (A-4a), silt and clay (A-6a), and clay (A-7-6). These layers ranged in consistency from stiff to very stiff. Granular soils encountered consisted of sandy silt (A-4a), coarse and fine sand (A-3a), gravel with sand and silt (A-2-4), and gravel with sand (A-1-b). These layers ranged in compactness from very loose to dense. Shale and sandstone bedrock was encountered at depths of 23.5 and 26.5 feet below the ground surface.

Due to the size of the structure, if H-piles are used, it is recommended that HP 14X73 H-pile sections, with a 95-ton capacity, be recommended. H-piles should be driven to refusal to the top of bedrock. H-piles driven to refusal may be designed based on the full allowable capacity of the pile. An alternative to driven H-piles would be the use of drilled shafts extending to bedrock. It is anticipated that at the abutments, significant amounts of fill will be placed and spread footings within the embankment fills may be considered. It does not appear reasonable that spread footings extending to bedrock could be used at the abutments due to the depth to bedrock. The following table summarizes the site conditions and preliminary foundation recommendations.

Mr. Greg Parsons, P.E.  
May 2, 2005  
Page 10

Foundation Recommendations – Ramp C - #2

Boring Number	Structural Element	Existing Ground Surface Elevation* (Feet)	Top of Rock Elevation* (Feet)	Estimated Drilled Shaft Tip Elevation*	Allowable Bearing Capacity for Drilled Shafts (TSF)	Allowable Bearing Capacity for Spread Footings (TSF)**
TR-46	Forward Abutment	543.0	517.0	513	20	1.5
TR-47	Pier	542.0	519.0	514	20	NR
TR-48	Rear Abutment	542.0	523.5	520	15	1.5

\*Existing ground surface elevation was estimated from the established topographic mapping.

\*\*Assuming spread footings founded on embankment fill.

**MSE Wall Stability**

Several MSE walls are proposed within the interchange, mainly along Ramps B and C. Based upon the borings drilled across the proposed interchange, it appears that global stability will not be an issue for the anticipated wall height. This is based on an assumption of a maximum wall height of 25 feet. Once the wall designs have been finalized the geometries of each wall will need to be evaluated for the global stability, sliding, overturning, and bearing capacity at each location. It should be noted that some settlement may be anticipated at some of the MSE wall locations, and wire-faced MSE walls may be considered if significant settlements are anticipated.

**General Information**

Minor amounts of settlement occurring within the very loose to loose granular soils are anticipated during construction of the embankments. Due to the granular nature of the soils, it is assumed that the settlement will occur during the earthwork activities, and will have been completed by the time the full height of the embankment has been constructed.

Because of the many geotechnical factors across the anticipated structure locations, and the design unknowns at this time, a detailed evaluation of all geotechnical parameters will need to be considered for the final design. It is strongly recommended that we discuss the proposed foundation design after TranSystems has had a chance to review these recommendations.



ENGINEERS • ARCHITECTS • SCIENTISTS  
PLANNERS • SURVEYORS

Mr. Greg Parsons, P.E.

May 2, 2005

Page 11

**Closing**

If you have any questions, please contact our office for clarification.

Sincerely,

**DLZ OHIO, INC.**

*P. Paul Painter*

P. Paul Painter  
Engineering Geologist

*Dorothy A. Adams  
for*

Arthur (Pete) Nix, P.E.  
Geotechnical Division Manager

Attachments: General Information – Drilling Procedures and Logs of Borings  
Legend – Boring Log Terminology  
Boring Location Plan  
Boring Logs TR-46 through TR-61

cc: File



Engineers • Architects • Scientists  
Planners • Surveyors  
www.dlzcorp.com

DLZ Ohio, Inc.  
6121 Huntley Road  
Columbus, Ohio 43229-1003  
Phone (614) 888-0040 Fax (614) 848-6712

SCI-823-0.00  
US 23 / SCI-823-0.00 Interchange

Boring Location Plan

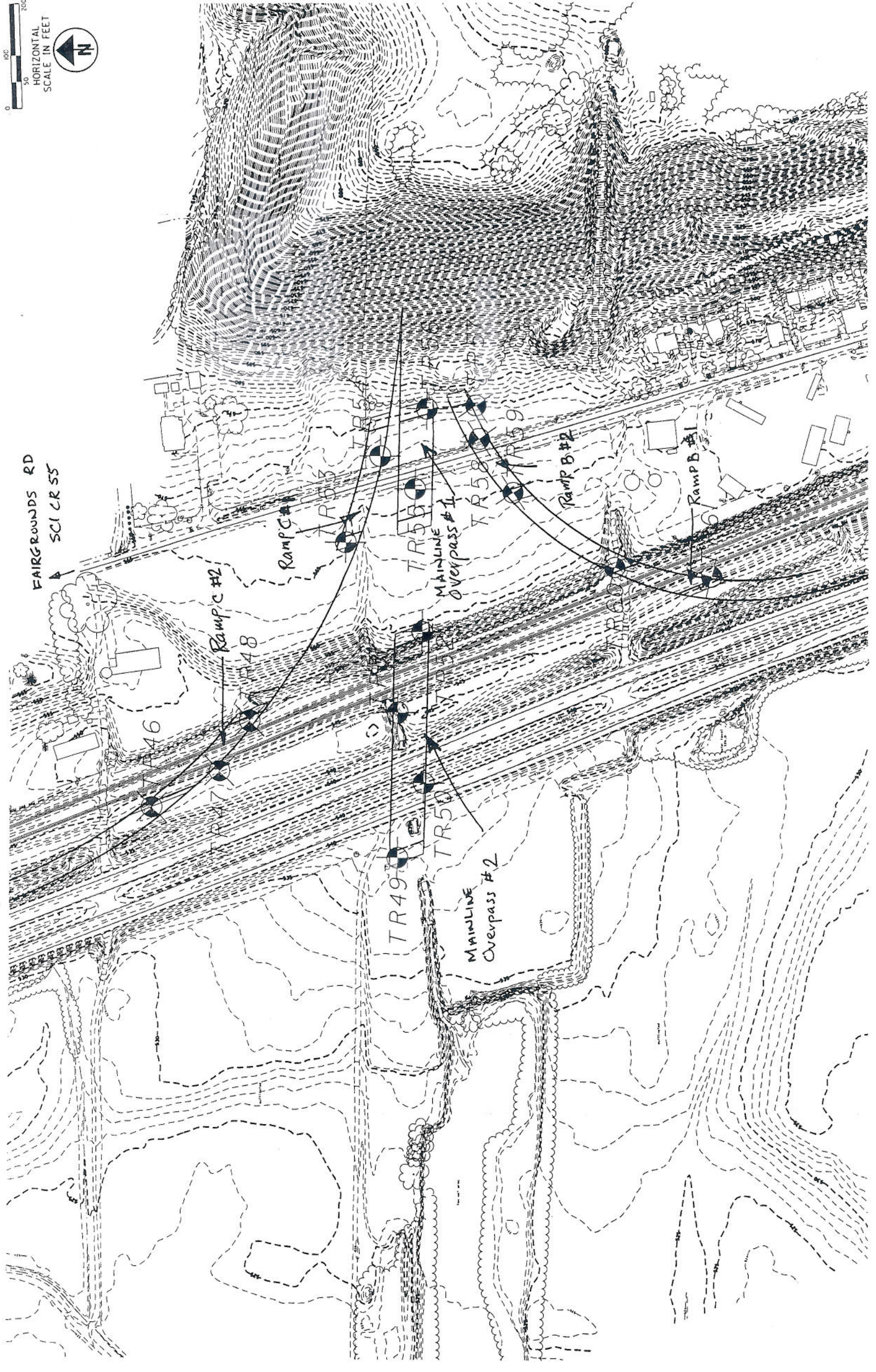
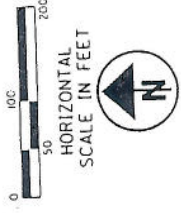

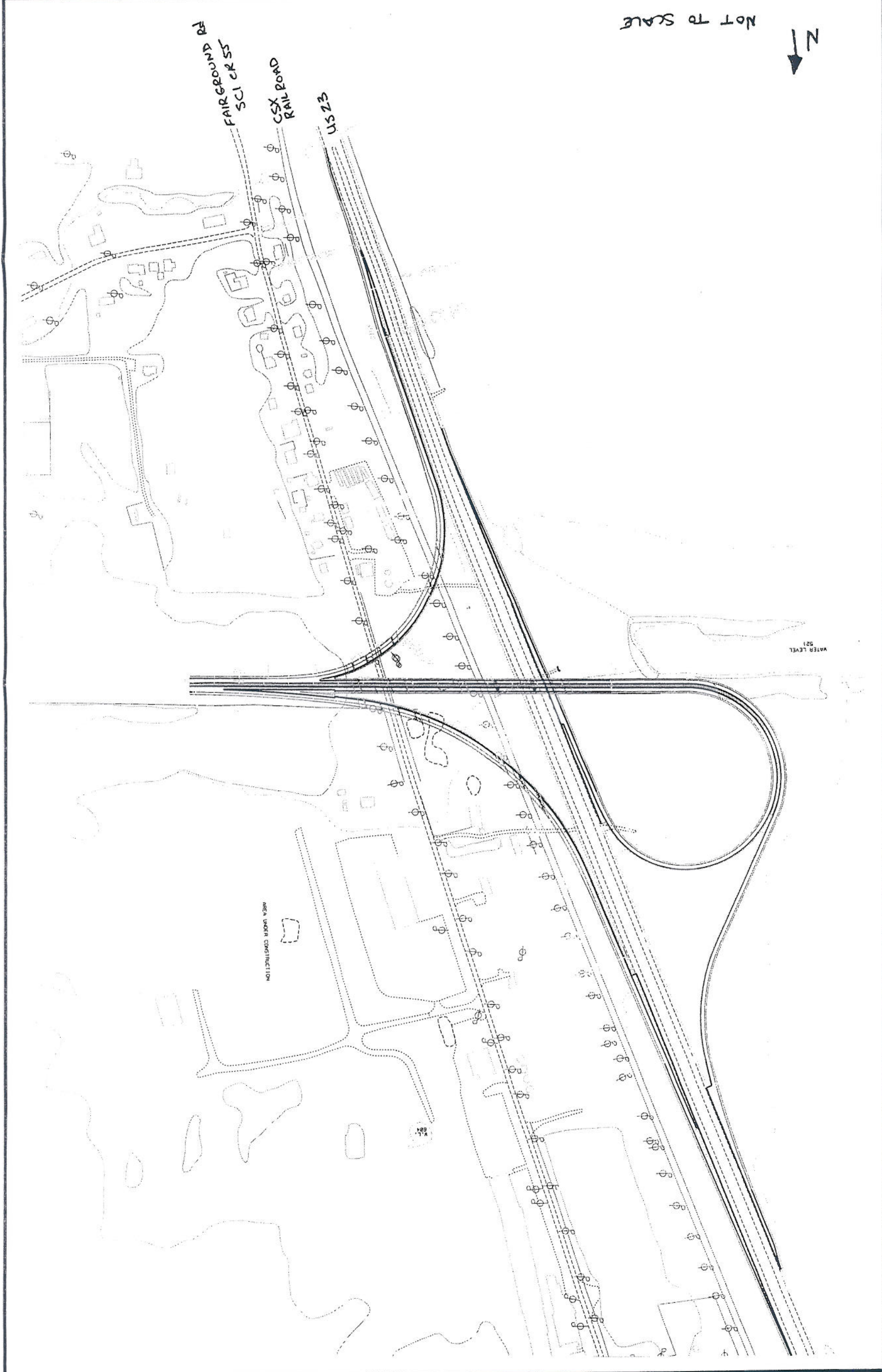

## GENERAL INFORMATION DRILLING PROCEDURES AND LOGS OF BORINGS

Drilling and sampling were conducted in accordance with procedures generally recognized and accepted as standardized methods of investigation of subsurface conditions concerning geotechnical engineering considerations. Borings were drilled with either a truck-mounted or ATV-mounted drill rig.

Drive split-barrel sampling was performed in 1.5 foot increments at intervals not exceeding 5 feet. In the event the sampler encountered resistance to penetration of 6 inches or less after 50 blows of the drop hammer, the sampling increment was discontinued. Standard penetration data were recorded and one or more representative samples were preserved from each sampling increment.

In borings where rock was cored, NXM or NQ size diamond coring tools were used.

In the laboratory all samples were visually classified by a geotechnical engineer. Moisture contents of representative fine-grained soil samples were determined. A limited number of samples, considered representative of foundation materials present, were selected for performance of grain-size analyses and plasticity characteristics tests. The results of these tests are shown on the boring logs.

The boring logs included in the Appendix have been prepared on the basis of the field record of drilling and sampling, and the results of the laboratory examination and testing of samples. Stratification lines on the boring logs indicating changes in soil stratigraphy represent depths of changes approximated by the driller, by sampling effort and recovery, and by laboratory test results. Actual depths to changes may differ somewhat from the estimated depths, or transitions may occur gradually and not be sharply defined. The boring logs presented in this report therefore contain both factual and interpretative information and are not an exact copy of the field log.

Although it is considered that the borings have disclosed information generally representative of site conditions, it should be expected that between borings conditions may occur which are not precisely represented by any one of the borings. Soil deposition processes and natural geologic forces are such that soil and rock types and conditions may change in short vertical intervals and horizontal distances.

Soil/rock samples will be stored at our laboratory for a period of six months. After this period of time, they will be discarded, unless notified to the contrary by the client.

## LEGEND – BORING LOG TERMINOLOGY

Explanation of each column, progressing from left to right

1. Depth (in feet) – refers to distance below the ground surface.
2. Elevation (in feet) – is referenced to mean sea level, unless otherwise noted.
3. Standard Penetration (N) – the number of blows required to drive a 2-inch O.D., 1-3/8 inch I.D., split-barrel sampler, using a 140-pound hammer with a 30-inch free fall. The blows are recorded in 6-inch drive increments. Standard penetration resistance is determined from the total number of blows required for one foot of penetration by summing the second and third 6-inch increments of an 18-inch drive.  
  
50/n – indicates number of blows (50) to drive a split-barrel sampler a certain number of inches (n) other than the normal 6-inch increment.
4. The length of the sampler drive is indicated graphically by horizontal lines across the "Standard Penetration" and "Recovery" columns.
5. Sample recovery from each drive is indicated numerically in the column headed "Recovery".
6. The drive sample location is designated by the heavy vertical bar in the "Sample No., Drive" column.
7. The length of hydraulically pressed "Undisturbed" samples is indicated graphically by horizontal lines across the "Press" column.
8. Sample numbers are designated consecutively, increasing in depth.
9. Soil Description
  - a. The following terms are used to describe the relative compactness and consistency of soils:

**Granular Soils – Compactness**

<u>Term</u>	<u>Blows/Foot Standard Penetration</u>
Very Loose	0 – 4
Loose	4 – 10
Medium Dense	10 – 30
Dense	30 – 50
Very Dense	over 50

**Cohesive Soils – Consistency**

<u>Term</u>	<u>Unconfined Compression tons/sq.ft.</u>	<u>Blows/Foot Standard Penetration</u>	<u>Hand Manipulation</u>
Very Soft	less than 0.25	below 2	Easily penetrated by fist
Soft	0.25 – 0.50	2 – 4	Easily penetrated by thumb
Medium Stiff	0.50 – 1.0	4 – 8	Penetrated by thumb with moderate pressure
Stiff	1.0 – 2.0	8 – 15	Readily indented by thumb but not penetrated
Very Stiff	2.0 – 4.0	15 – 30	Readily indented by thumb nail
Hard	over 4.0	over 30	Indented with difficulty by thumb nail

- b. Color – If a soil is a uniform color throughout, the term is single, modified by such adjective as light and dark. If the predominant color is shaded by a secondary color, the secondary color precedes the primary color. If two major and distinct colors are swirled throughout the soil, the colors are modified by the term "mottled".
- c. Texture is based on the Ohio Department of Transportation Classification System. Soil particle size definitions are as follows:

<u>Description</u>	<u>Size</u>	<u>Description</u>	<u>Size</u>
Boulders	Larger than 8"	Sand – Coarse	2.0 mm to 0.42 mm
Cobbles	8" to 3"	– Fine	0.42 mm to 0.074 mm
Gravel – Coarse	3" to ¾"	Silt	0.074 mm to 0.005 mm
– Fine	¾" to 2.0 mm	Clay	smaller than 0.005 mm



d. The main soil component is listed first. The minor components are listed in order of decreasing percentage of particle size.

e. Modifiers to main soil descriptions are indicated as a percentage by weight of particle sizes.

trace	0 to 10%
little	10 to 20%
some	20 to 35%
"and"	35 to 50%

f. Moisture content of **cohesionless soils** (sands and gravels) is described as follows:

<u>Term</u>	<u>Relative Moisture or Appearance</u>
Dry	No moisture present
Damp	Internal moisture, but none to little surface moisture
Moist	Free water on surface
Wet	Voids filled with free water

g. The moisture content of **cohesive soils** (silts and clays) is expressed relative to plastic properties.

<u>Term</u>	<u>Relative Moisture or Appearance</u>
Dry	Powdery
Damp	Moisture content slightly below plastic limit
Moist	Moisture content above plastic limit but below liquid limit
Wet	Moisture content above liquid limit

10. Rock Hardness and Rock Quality Designation

a. The following terms are used to describe the relative hardness of the **bedrock**.

<u>Term</u>	<u>Description</u>
Very Soft	Permits denting by moderate pressure of the fingers. Resembles hard soil but has rock structure. (Crushes under pressure of fingers and/or thumb)
Soft	Resists denting by fingers, but can be abraded and pierced to shallow depth by a pencil point. (Crushes under pressure of pressed hammer)
Medium Hard	Resists pencil point, but can be scratched with a knife blade. (Breaks easily under single hammer blow, but with crumbly edges.)
Hard	Can be deformed or broken by light to moderate hammer blows. (Breaks under one or two strong hammer blow, but with resistant sharp edges.)
Very Hard	Can be broken only by heavy and in some rocks repeated hammer blows.

b. Rock Quality Designation, RQD – This value is expressed in percent and is an indirect measure of rock soundness. It is obtained by summing the total length of all core pieces which are at least four inches long, and then dividing this sum by the total length of the core run.

- 11. Gradation – when tests are performed, the percentage of each particle size is listed in the appropriate column (defined in Item 9c).
- 12. When a test is performed to determine the natural moisture content, liquid limit moisture content, or plastic limit moisture content, the moisture content is indicated graphically.
- 13. The standard penetration (N) value in blows per foot is indicated graphically.

LOG OF: Boring TR-46 Location: Forward Abutment - Ramp C - #2 Date Drilled: 03/17/05

Depth (ft)	Elev. (ft)	Blows per 6"	Recovery (in)	Sample No.	Drive	Press / Core	Hand Penetrometer (tsf)	WATER OBSERVATIONS:	DESCRIPTION	GRADATION						STANDARD PENETRATION (N) Natural Moisture Content, % - ● PL ——— LL ○ Blows per foot - ○			
										% Aggregate	% C. Sand	% M. Sand	% F. Sand	% Silt	% Clay				
0.1	543.0							Water seepage at: 13.5'-19.0'	Topsoil - 1"										
5.5	542.9	2	1	1	2			Water level at completion: 6.0' (Prior to coring) 5.0' (Including drill water)	FILL: Very loose brown and black GRAVEL WITH SAND (A-1-b), some silty clay; contains roots; damp.	44	19	--	13	16	8				
8.5	537.5	3	3	3	18		2.0		Stiff brown SILT AND CLAY (A-6a), little fine to coarse gravel, trace fine to coarse sand; damp to moist.	56	15	--	9	16	4				
10	534.5	2	6	6	12				Medium dense brown and gray GRAVEL WITH SAND (A-1-b), little silty clay; moist.	33	31	--	13	20	3				
13.5	529.5	3	4	3	8				Loose brown GRAVEL WITH SAND (A-1-b), trace silt, trace clay; wet.										
15		5	4	4	12				@ 18.0', heaving sand.										
19.0	524.0	16	15	20	14				Dense light brown GRAVEL WITH SAND AND SILT (A-2-4), trace clay, trace fine to coarse gravel; moist to wet.										
20		14	19	20	8				@ 23.0', gray.										
25		5	5	12	14														
26.0	517.0	50/3	3						Hard gray SANDSTONE; very fine to fine grained, slightly weathered, argillaceous, micaceous, laminated to medium bedded, slightly fractured. @ 29.4', very thin clay seam. @ 29.8', 30.8', thin clay seam.	30	11	--	24	25	9				

LOG OF: Boring TR-46

Depth (ft)	Elev. (ft)	Blows per 6"	Recovery (in)	Sample No.		Hand Penetrometer (tsf)	WATER OBSERVATIONS:	GRADATION						STANDARD PENETRATION (N) Natural Moisture Content, % - ● PL ——— LL Blows per foot - ○				
				Drive	Press / Core			% Aggregate	% C. Sand	% M. Sand	% F. Sand	% Silt	% Clay					
30	513.0						Water seepage at: 13.5'-19.0' Water level at completion: 6.0' (Prior to coring) 5.0' (including drill water)											
35		Core 120"	Rec 118"	RQD 83%			Hard gray SANDSTONE; very fine to fine grained, slightly weathered, argillaceous, micaceous, laminated to medium bedded, slightly fractured. @ 31.4', very thin clay seam. @ 31.6'-32.0', broken zone with clay and rock fragments. @ 33.4'-33.7', clay layer. @ 33.7'-34.2', cross bedded.											
37.0	506.0						@ 35.9', very thin clay seam. Bottom of Boring - 37.0'											
40																		
45																		
50																		
55																		
60																		

Depth (ft)	Elev. (ft)	Blows per ft	Recovery (in)	Sample No.		Hand Penetrometer (tsf)	WATER OBSERVATIONS	GRADATION						STANDARD PENETRATION (N) Natural Moisture Content, % - PL ——— LL Blows per foot - ○ 40			
				Drive	Press / Core			% Aggregate	% C. Sand	% M. Sand	% F. Sand	% Silt	% Clay				
0.1	542.0						Topsoil - 1"										
	541.9	1	10	1		1.5	Stiff brown and gray CLAY (A-7-6), trace fine sand; slightly organic; moist.										
5		2	13	2		2.5	@ 3.0', very stiff.										
7.0	535.0	4	15	3		4.5	@ 6.0', hard.										
10		1	10	4		0.5	Medium stiff brown SANDY SILT (A-4a), trace gravel, trace clay; moist to wet.										
13.0	529.0	2	7	5		--											
15		WOH	18	6		--	Very loose brown COARSE AND FINE SAND (A-3a), trace clay; wet.										
18.0	524.0	WOH	18	7		--											
20		11	10	8		1.5	Stiff brown SANDY SILT (A-4a), some gravel; moist.										
21.0	521.0	14	12	9		--											
23.0	519.0	42	12	10		--	Very stiff to hard dark gray SANDY SILT (A-4a), little clay; moist.										
25		34	11	11		--	Very soft black SHALE; highly weathered, carbonaceous, laminated, broken, contains silt filled high angle fracture.										
26.5	515.5	10	11	12		--											
30		21	4	11		--	Hard gray SANDSTONE; very fine to fine grained, slightly weathered, argillaceous, micaceous, laminated to medium bedded, slightly fractured.										
		50/4	4	11		--	@ 26.7'-28.4', 30.0'-30.2', vertical healed fracture.										

**LOG OF: Boring TR-47**

Location: Pier location - Ramp C - #2

Date Drilled: 03/17/05

Depth (ft)	Elev. (ft)	Blows per 6"	Recovery (in)	Sample No.		Hand Penetrometer (tsf)	WATER OBSERVATIONS:	GRADATION						STANDARD PENETRATION (N) Natural Moisture Content, % - ● PL ——— LL Blows per foot - ○			
				Drive	Press / Core			% Aggregate	% C. Sand	% M. Sand	% F. Sand	% Silt	% Clay				
30	512.0						Water seepage at: 13.0'-18.0' Water level at completion: 18.0' (Prior to coring) 9.0' (Including drill water)										
		Core 120"	Rec 120"	RQD 74%	R1		Hard gray SANDSTONE; very fine to fine grained, slightly weathered, argillaceous, micaceous, laminated to medium bedded, slightly fractured. @ 30.2'-32.4'; 34.7'-35.4', high angle bedding. @ 31.8'-32.4', broken zone with thin clay seam. @ 33.1'-33.6', low angle healed fracture. @ 33.1'-33.6'; high angle healed fracture. @ 33.7'-34.0', very argillaceous. @ 33.7', Highly weathered fracture.										
36.5	505.5							Bottom of Boring - 36.5'									
40																	
45																	
50																	
55																	
60																	

Depth (ft)	Elev. (ft)	Blows per 6"	Recovery (in)	Sample No.	Drive	Press / Core	Hand Penetro-meter (tsf)	WATER OBSERVATIONS:	GRADATION					STANDARD PENETRATION (N) Natural Moisture Content, % - ● PL ——— LL Blows per foot - ○			
									% Aggregate	% C. Sand	% M. Sand	% F. Sand	% Silt		% Clay		
0	547.0							Water seepage at: 13.0'-18.0' Water level at completion: 8.0' measured inside of augers									
3.0	544.0	2 2 3 14		1				FILL: Loose brown GRAVEL WITH SAND (A-1-b); contains mostly coal fragments and cinders; dry to damp.									
5		WOH WOH WOH	1	2				FILL: Very loose brown SILT AND CLAY (A-6a), little fine to coarse sand; contains roots, coal and cinder fragments; damp.									
6.5	540.5	WOH 2 3	16	3			2.5	Very stiff brown and gray SILT AND CLAY (A-6a), trace fine to coarse sand, trace gravel; damp to moist.	0	0	--	2	43	55			
10		2 5 7 17		4			3.5										
13.0	534.0	2 5 6 15		5			3.5										
15		1 2 2 5		6				Very loose brown COARSE AND FINE SAND (A-3a), little to some gravel, trace clay; wet.	37	27	--	17	20				Non-Plastic
18.0	529.0	1 1 1 8		7				Medium dense brown SANDY SILT (A-4a), some gravel, little clay; moist.	52	14	--	15	12	7			Non-Plastic
20		6 6 7 10		8				@ 21.0', trace gravel and trace clay.									
23.5	523.5	2 7 30 15		9				Soft to medium hard black SHALE; very fine grained, slightly weathered, very thinly bedded, highly fractured. @ 25.3'-25.6', 26.0'-26.4', broken 27.15'-27.2', sandstone seam.									
25		20 15 50 12		10													
30		Core Rec 120" 120"															

Client: TranSystems, Inc.

Project: SCI-823-0.00

Job No. 0121-3070.03

**LOG OF: Boring TR-48**

Location: Rear Abutment - Ramp C - #2

Date Drilled: 3/21/05

Depth (ft)	Elev. (ft)	Blows per 6"	Recovery (in)	Sample No.		Hand Penetrometer (tsf)	WATER OBSERVATIONS:	GRADATION	STANDARD PENETRATION (N) Natural Moisture Content, % - PL ——— LL Blows per foot - ○ — 40
				Drive	Press / Core				
29.9	517.0						Water seepage at: 13.0'-18.0' Water level at completion: 8.0' measured inside of augers	% Aggregate	
	517.1							% C. Sand	
								% M. Sand	
								% F. Sand	
								% Silt	
								% Clay	
35.0	512.0						Hard gray SANDSTONE; fine grained, slightly weathered, thinly bedded. @ 32.9' fracture		
40									
45									
50									
55									
60							Bottom of Boring - 35.0'		

Depth (ft)	Elev. (ft)	Blows per 6"	Recovery (in)	Sample No.	Drive	Press / Core	Hand Penetro-meter (tsf)	WATER OBSERVATIONS:	GRADATION						STANDARD PENETRATION (N) Natural Moisture Content, % - ● PL Blows per foot - ○		
									% Aggregate	% C. Sand	% M. Sand	% F. Sand	% Silt	% Clay			
0	537.5							Water seepage at: 18.0'-28.0' Water level at completion: 14.0' measured inside of augers									
		4 5 7	17	1			4.5+	<b>DESCRIPTION</b>  Hard brown SILT AND CLAY (A-6a), little fine to coarse sand, trace gravel; damp.  @ 6.0', stiff; moist.  @ 11.0', little gravel.  Loose brown SANDY SILT (A-4a), trace to little gravel, trace clay; moist.  Loose brown SILT (A-4b); moist.  Very loose brown GRAVEL WITH SAND (A-1-b), trace to little clay; moist to wet.  @ 21.0', medium dense.  @ 29.0', possible broken sandstone.									
		3 4 4	16	2			4.0										
		3 5 5	16	3			1.5										
		2 2 3	17	4			1.0										
		3 4 5	18	5			1.5										
13.0	524.5	WOH 2 2	18	6													
15.5	522.0																
		1 2 3	18	7													
18.0	519.5	WOH WOH WOH	3	8													
		5 9 18	12	9													
		2 2 6	18	10													
25		6 5 8	13	11													
		10 43 50/4	18	12													



LOG OF: Boring TR-49A Location: Forward Abutment - Mainline Overpass # 2 Date Drilled: 3/21/05

Depth (ft)	Elev. (ft)	Blows per ft	Recovery (in)	Sample No.	Drive	Press / Core	Hand Penetrometer (tsf)	WATER OBSERVATIONS:	GRADATION						STANDARD PENETRATION (N) Natural Moisture Content, % - ● PL ——— LL Blows per foot - ○			
									% Aggregate	% C. Sand	% M. Sand	% F. Sand	% Silt	% Clay				
30	507.5							Water seepage at: 18.0'-28.0' Water level at completion: 14.0' measured inside of augers										
32.0	505.5							Very loose brown GRAVEL WITH SAND (A-1-b), trace to little clay (possible broken sandstone); moist to wet.  Medium hard gray SANDSTONE; fine grained, slightly weathered, argillaceous, broken, multiple clay seams, low and high angled fractures.										
35		50/2	1		13													
40																		
45.0	492.5																	
50																		
55																		
60																		

Bottom of Boring - 45.0'

Depth (ft)	Elev. (ft)	Blows per 6"	Recovery (in)	Sample No.	Hand Penetrometer (tsf)	WATER OBSERVATIONS:	GRADATION	STANDARD PENETRATION (N)
0.1	540.0					Water seepage at: 18.0'-25.0'		
	539.9					Water level at completion: 18.0' measured inside of augers		
3.0	537.0	3 2 3	10	1	1.0	Topsoil -1"	1 4 -	10 20 30 40
5		2 1 2	8	2	1.0	FILL: Loose dark brown SANDY SILT (A-4a), trace gravel; contains roots; damp.	7 57 33	
		2 3 3	13	3	2.0	Stiff brown SILT AND CLAY (A-6a), trace fine to coarse sand, trace gravel; moist.	32 20 -	
10.5	529.5	1 2 3	16	4	1.5	@ 6.0'-7.5', little to some gravel.	12 18 18	
		1 2 3	18	5	1.25	Stiff brown SILTY CLAY (A-6b), little gravel, trace fine to coarse sand; moist to wet.	15 40 -	
15		WOH 2 3	18	6	1.5	@ 16.0', trace gravel and some fine to coarse sand.	23 21	
		1 1 2	18	7	1.25	Very loose to loose brown COARSE AND FINE SAND (A-3a), trace clay, trace gravel; wet.	42 24 -	
18.0	522.0	WOH 1 3	16	8		Medium dense brown GRAVEL WITH SAND (A-1-b), trace clay; wet.	14	
20		2 5 11	16	9		Medium hard brownish gray SANDSTONE; highly weathered.		
21.0	519.0	2 7 50	18	10		Hard gray SANDSTONE; fine grained, slightly weathered, argillaceous, medium bedded.		
24.5	515.5	25 37 50/4	10	11		@ 28.1'-28.7', 29.0'-29.1' clay seams		
27.5	512.5							
30								

LOG OF: Boring TR-50A Location: Pier # 2 - Mainline Overpass # 2 Date Drilled: 3/22/05

Depth (ft)	Elev. (ft)	Blows per 6"	Recovery (in)	Sample No.	Drive	Press / Core	Hand Penetrometer (tsf)	WATER OBSERVATIONS:	GRADATION						STANDARD PENETRATION (N) Natural Moisture Content, % - PL ——— LL Blows per foot - ○ 40 10 20 30		
									% Aggregate	% C. Sand	% M. Sand	% F. Sand	% Silt	% Clay			
30	510.0							Water seepage at: 18.0'-25.0' Water level at completion: 18.0' measured inside of augers									
		Core 120"	Rec 117"		RQD 68%			Hard gray SANDSTONE; fine grained, slightly weathered, argillaceous, medium bedded. @ 33.3', 34.3'-34.4', 36.2', 37.2', clay seams @ 30.8'-32.1'; high angle fracture.									
	502.5							Bottom of Boring - 37.5'									
35																	
40																	
45																	
50																	
55																	
60																	

Depth (ft)	Elev. (ft)	Blows per 6"	Recovery (in)	Sample No.	Drive	Press / Core	Hand Penetro-meter (tsf)	WATER OBSERVATIONS:	GRADATION						STANDARD PENETRATION (N) Natural Moisture Content, % - ● PL ——— LL Blows per foot - ○			
									% Aggregate	% C. Sand	% M. Sand	% F. Sand	% Silt	% Clay				
0.1	545.0							Water seepage at: 13.0'-18.0'										
	544.9							Water level at completion: 21.0' (Prior to coring) 13.0' (Including drill water)										
		1	7	1	1		2.0	Topsoil - 2"										
		2						Stiff dark brown SILT AND CLAY (A-6a), little fine to coarse sand, trace fine to coarse gravel; damp to moist.										
5.5	539.5	1	13	2	2		1.0	Very stiff brown SILTY CLAY (A-6b), trace fine to coarse sand, trace fine to coarse gravel; damp.										
		2	8					Very loose to loose brown GRAVEL WITH SAND (A-1-b); damp.										
		3						@ 11.0', moist.										
8.0	537.0	3	10	4	4		2.0	Very loose brown COARSE AND FINE SAND (A-3a), trace fine to coarse gravel, trace clay; wet.	43	28	--	11	7	11				
		4						Medium dense reddish brown SANDY SILT (A-4a), little gravel; damp to moist.	12	28	--	45	15	15				
13.0	532.0	1	7	5	1		1.5	Stiff gray CLAY (A-7-6); moist.	19	19	--	30	24	8				
		WOH	18					Medium hard black SHALE; moderately weathered, pyritic, laminated, broken.	0	0	--	1	43	55				
		WOH						@ 28.1'-28.2', gray.										
		WOH	18					Hard gray SANDSTONE										
18.0	527.0	16	18	8	8													
		7																
		14	14															
23.0	522.0	1	11	10	3		1.5											
		3	11															
25.5	519.5	20	8	11	5													
		50/3																
28.6	516.4																	
30																		

**LOG OF: Boring TR-51**

Location: Pier # 1 - Mainline Overpass # 2

Date Drilled: 03/17/05

Depth (ft)	Elev. (ft)	Blows per 6"	Recovery (in)	Sample No.	Drive	Press / Core	Hand Penetrometer (tsf)	WATER OBSERVATIONS:	DESCRIPTION	GRADATION						STANDARD PENETRATION (N) Natural Moisture Content, % - ● PL ——— LL Blows per foot - ○		
										% Aggregate	% C. Sand	% M. Sand	% F. Sand	% Silt	% Clay			
30	515.0							Water seepage at: 13.0'-18.0' Water level at completion: 21.0' (Prior to coring) 13.0' (Including drill water)										
		Core 120"	Rec 116"		RQD 71%				Hard gray SANDSTONE; very fine to fine grained, slightly weathered, argillaceous, micaceous, very thinly bedded to medium bedded. @ 28.7'-28.8', pyritic. @ 31.8', very thin clay seam. @ 33.1'-33.3', clay and gravel seam. @ 33.5', fracture. @ 34.5', very thin clay seam. @ 35.5'-36.2', broken zone with clay infilling. @ 36.6'-36.8', highly weathered.									
35																		
37.5	507.5								Bottom of Boring - 37.5'									
40																		
45																		
50																		
55																		
60																		

Client: TranSystems, Inc.

Project: SCI-823-0-00

Job No. 0121-3070.03

Location: Rear Abutment - Mainline Overpass # 2 Date Drilled: 03/15/05

LOG OF: Boring TR-52

Depth (ft)	Elev. (ft)	Blows per 6"	Recovery (in)	Sample No.		Hand Penetrometer (tsf)	WATER OBSERVATIONS:	DESCRIPTION	GRADATION						STANDARD PENETRATION (N) Natural Moisture Content, % - ● PL  -----  LL Blows per foot - ○						
				Drive	Press / Core				% Aggregate	% C. Sand	% M. Sand	% F. Sand	% Silt	% Clay							
30	528.0						Water seepage at: 23.0'-30.0' Water level at completion: 27.0' (Prior to coring) 6.0' (including drill water)														
33.5	524.5	22 50/5	10	13				Medium dense brown SANDY SILT (A-4a), trace clay; wet.													
35								Medium hard black SHALE; moderately weathered, pyritic, laminated, broken.													
40	517.6							Hard gray SANDSTONE; very fine to fine grained, slightly weathered, argillaceous, micaceous, very thinly bedded to medium bedded.													
40.4																					
45.0	513.0																				
50																					
55																					
60																					

Depth (ft)	Elev. (ft)	Blows per 6"	Recovery (in)	Sample No.	Hand Penetro-meter (tsf)	WATER OBSERVATIONS: Water seepage at: None Water level at completion: Dry (Prior to coring) 11.0' (Including drill water)	DESCRIPTION	GRADATION						STANDARD PENETRATION (N) Natural Moisture Content, % - ● PL _____ LL Blows per foot - ○									
								% Aggregate	% C. Sand	% M. Sand	% F. Sand	% Silt	% Clay										
0.2	567.5																						
0.5	567.3	2		1	1.0		Topsil - 3"																
		2	14				Stiff to very stiff brown SILT AND CLAY (A-6a), trace fine to coarse sand; damp. @ 0.0'-2.5', contains roots.	0	0	4	61	35											
		2	17	2	3.5			0	0	-	-	12	67	21									
5	562.0			3	2.25		Very stiff brown SANDY SILT (A-4a), trace clay; damp.																
		3	18																				
		5	6																				
		1	11	4	2.0		Loose dark brown COARSE AND FINE SAND (A-3a), trace to little clay, trace gravel; damp.																
10	557.0																						
		1	13																				
		2	13																				
		3	13																				
		7	35				Soft gray SHALE; moderately weathered.																
13.6	553.9			6			Medium hard gray SHALE; fine grained, moderately weathered, laminated. @ 15.0'-17.3', broken with high angles fractures and thin clay seams. @ 18.9'-19.0', 20.6'-20.9', high angle fractures.	8	38	-	37	18											
		50/4	14																				
15.0	552.5																						
		Core	120"	R-1			Hard gray SILTSTONE; very fine to fine grained, slightly weathered, argillaceous, medium bedded, slightly fractured. Hard gray SHALE; slightly weathered, argillaceous, very thinly bedded.																
		120"	120"																				
20																							
22.6	544.9																						
23.5	544.0																						
25.0	542.5																						
30																							

**LOG OF: Boring TR-55A**

Location: Forward Abutment - Mainline Overpass #1

Date Drilled: 3-15-05

Depth (ft)	Elev. (ft)	Blows per 6"	Recovery (in)	Sample No.		Hand Penetrometer (tsf)	WATER OBSERVATIONS:	DESCRIPTION	GRADATION						STANDARD PENETRATION (N) Natural Moisture Content, % - PL ——— LL Blows per foot - ○ 40				
				Drive	Press/Core				% Aggregate	% C. Sand	% M. Sand	% F. Sand	% Silt	% Clay					
0	565.5						Water seepage at: 13.0'-18.0'												
3.0	562.5	3 5 5	10	1		4.5+	Water level at completion: 18.0' (Prior to coring) 18.0' (Including drill water)	Hard gray SILTY CLAY (A-6b); damp.											
5		6 7 7	9	2		4.5+		Hard brown SILT AND CLAY (A-6a), trace fine to coarse sand, trace gravel; damp.											
8.0	557.5	11 11 9	12	3		4.5+		Very stiff to hard brown SANDY SILT (A-4a), trace gravel; damp.	22	15	--	23	21	19					
10		4 5 4	14	4		3.5		@ 11.0'; hard.	5	25	--	39	16	16					
13.0	552.5	5 4 3	12	5		4.5+		Loose brown COARSE AND FINE SAND (A-3a), trace gravel; wet.	9	38	--	41	13						
15		2 2 2	15	6				Hard gray SHALE interbedded with SANDSTONE; fine grained, highly weathered, very thinly bedded, highly fractured. @ 20.0'-22.0', 26.7'-27.5', 28.3'-28.5', 29.3'-29.6', highly fractured with clay seams. @ 21.0'-21.3', 21.7'-21.9', 26.5'-26.7', 26.9'-22.0', Hard brown sandstone; slightly weathered laminated.											
18.0	547.5	1 2 2	7	7															
20		35 50/5	12	8															
25																			
30.0	535.5																		

Bottom of Boring - 30.0'



Client: TranSystems, Inc.

Project: SCI-823-0.00

Job No. 0121-3070.03

**LOG OF: Boring TR-55A**

Location: Forward Abutment - Mainline Overpass #1

Date Drilled: 3-15-05

Depth (ft)	Elev. (ft)	Blows per ft <sup>2</sup>	Recovery (in)	Sample No.	Drive Press /Core	Hand Penetro- meter (tsf)	WATER OBSERVATIONS:	GRADATION						STANDARD PENETRATION (N) Natural Moisture Content, % - ● PL — LL Blows per foot - ○ 10 20 30 40							
								% Aggregate	% C. Sand	% M. Sand	% F. Sand	% Silt	% Clay								
30	535.5						Water seepage at: 13.0'-18.0' Water level at completion: 18.0' (Prior to coring) 18.0' (Including drill water)														
35																					
40																					
45																					
50																					
55																					
60																					

Depth (ft)	Elev. (ft)	Blows per 6"	Recovery (in)	Sample No.	Hand Penetrometer (tsf)	WATER OBSERVATIONS:	GRADATION						STANDARD PENETRATION (N) Natural Moisture Content, % - ● PL ——— LL Blows per foot - ○		
							% Aggregate	% C. Sand	% M. Sand	% F. Sand	% Silt	% Clay			
0.2	569.5					Water seepage at: None									
0.2	569.3					Water level at completion: Dry (Prior to coring) 7.5' (Including drill water)									
3.0	566.5	2 2 3	15	1	2.5	Topsoil -3"									
5		4 6 9	17	2	4.5+	Very stiff brown SANDY SILT (A-4a), trace clay, trace gravel; damp to moist.									
8.0	561.5	4 6 9	16	3	4.25	Hard brown SILT AND CLAY (A-6a), trace fine to coarse sand, trace gravel; damp.	0	0	2	58	41				
10		2 2 3	18	4		Loose brown and gray SANDY SILT (A-4a), trace clay; damp to moist.	0	1	19	55	25				
14.1	555.4	8 23 50/4	15	6		Medium hard grayish brown SILTSTONE interbedded with SHALE; very fine to fine grained, slightly weathered, argillaceous, thinly bedded, highly fractured. @ 16.4'-17.2'; high angle fracture and clay seam. @ 17.2'; gray. @ 19.2'-19.7'; clay seam. @ 20.4'-20.8'; highly broken, clay seam.									
20		Core Rec 120" 120"		RQD 68%											
25.0	544.5					Bottom of Boring - 25.0'									

LOG OF: Boring TR-57 Location: Rear Abutment - Ramp B - #2 Date Drilled: 3-16-04

Project: SCI-823-0.00

Depth (ft)	Elev. (ft)	Blows per 6"	Recovery (in)	Sample No.	Drive Press / Core	Hand Penetro-meter (Isf)	WATER OBSERVATIONS: Water seepage at: None Water level at completion: Dry (Prior to coring) 3.5' (Including drill water)	GRADATION						STANDARD PENETRATION (N) Natural Moisture Content, % - ● PL ——— LL Blows per foot - ○					
								% Aggregate	% C. Sand	% M. Sand	% F. Sand	% Silt	% Clay						
0.3	569.5																		
	569.2	2	14	1		4.0	Topsoil -4" Very stiff to hard brown SILT AND CLAY (A-6a), trace fine to coarse sand; damp.	0	0	1	64	35							
5		3	12	2		4.5		0	0	10	67	23							
		5	17	3		3.5		0	0	19	26	17							
8.0	561.5	4		4		1.0		23	15	0	2	64	31						
10	559.0	1	18	5				0	2	0	4	64	31						
		2	14	6				Soft to medium hard gray SHALE; moderately weathered, laminated. @ 15.8'-16.3', 19.1'-19.5', clay seams	0	2	4	64	31						
14.0	555.5	12	13	6			Hard gray SILTSTONE interbedded with SHALE; slightly weathered, laminated. @ 22.7'-22.9' high angle fracture	0	2	4	64	31							
15		27					Hard gray SHALE; slightly weathered, laminated, slightly fractured.	0	2	4	64	31							
		50/3					Bottom of Boring - 25.0'	0	2	4	64	31							
20.9	548.6							0	2	4	64	31							
22.9	546.0							0	2	4	64	31							
25.0	544.5							0	2	4	64	31							
30								0	2	4	64	31							

Depth (ft)	Elev. (ft)	Blows per 6"	Recovery (in)	Sample No.	Drive Press / Core	Hand Penetro-meter (tsf)	WATER OBSERVATIONS: Water seepage at: None Water level at completion: Dry (Prior to coring) 4.0' (Including drill water)	GRADATION						STANDARD PENETRATION (N) Natural Moisture Content, % - ● PL ——— LL Blows per foot - ○				
								% Aggregate	% C. Sand	% M. Sand	% F. Sand	% Silt	% Clay					
0.3	567.0																	
1	566.7	1	16	1		--												
2		2	16															
3		3	15	2		4.25												
4		4	15															
5		5	18	3		3.5												
6		6	18															
7		7	18															
8.0	559.0																	
9		9	16	4														
10		10	16															
11		11	16															
12		12	15	5														
13		13	15															
14		14	15															
14.0	553.0																	
15		15	16	6														
16		16	16															
17		17	16															
18		18	16															
19		19	16															
20		20	16															
20		Core 120"	Rec 120"	RQD 82%	R-1													
25.0	542.0																	
30																		

Bottom of Boring - 25.0'

**LOG OF: Boring TR-59A**

Location: Forward Abutment - Ramp B - #2 Date Drilled: 3-14-05

Depth (ft)	Elev. (ft)	Blows per 6"	Recovery (in)	Sample No.	Hand Penetro-meter (tsf)	WATER OBSERVATIONS:	GRADATION					STANDARD PENETRATION (N) Natural Moisture Content, % - ● PL — LL Blows per foot - ○ * 40								
							% Aggregate	% C. Sand	% M. Sand	% F. Sand	% Silt		% Clay							
0	564.5																			
3		3	14	1																
5	559.0	2	12	2																
2		2	15	3																
2		2	13	4																
10	554.0	2	16	5																
1		1	15	6																
2		2	12	7																
0		0	14	8																
1		1	12	9																
21.5	543.0	36	12	10																
32		50/3	9																	
25.0	539.5																			
30																				

**DESCRIPTION**

Loose dark gray SANDY SILT (A-4a), trace clay, trace gravel; damp.

@ 3.5', brown; Moist.

Very loose to loose brown COARSE AND FINE SAND (A-3a), trace clay, trace silt; moist.

Loose brown SANDY SILT (A-4a), little gravel, trace clay; damp to moist.

@ 16.0', little to some clay.

@ 19.0'-21.5', wet.

Medium hard gray SHALE; slightly weathered.

Medium hard to hard gray SILTSTONE interbedded with SHALE; very fine to fine grained, slightly weathered, argillaceous, thinly bedded, slightly fractured.

@ 25.4'-25.7', 28.5', 29.6', clay seams

@ 25.9', 26.5-26.7', 27.8', high angle fractures

@ 28.6'-29.6', moderately weathered SHALE.

**LOG OF: Boring TR-59A**

Location: Forward Abutment - Ramp B - #2

Date Drilled: 3-14-05

Depth (ft)	Elev. (ft)	Blows per 6"	Recovery (in)	Sample No.	Drive	Press / Core	Hand Penetrometer (tsf)	WATER OBSERVATIONS:	GRADATION						STANDARD PENETRATION (N) Natural Moisture Content, % - ● PL ——— LL Blows per foot - ○ 40				
									% Aggregate	% C. Sand	% M. Sand	% F. Sand	% Silt	% Clay					
30	534.5							Water seepage at: 19'-21.5' Water level at completion: Dry (Prior to coring) 17.0' (including drill water)											
33.0	531.5							<b>DESCRIPTION</b>  Medium hard to hard gray SILTSTONE interbedded with SHALE; very fine to fine grained, slightly weathered, argillaceous, thinly bedded, slightly fractured. @ 31.4'-31.7', clay seams with high angle fractures Hard black SHALE; fine grained, slightly weathered, carbonaceous, thinly bedded. @ 33.8'-34.0', high angle fractures and broken.  Bottom of Boring - 35.0'											
35.0	529.5																		
40																			
45																			
50																			
55																			
60																			

Date Drilled: 3-14-05

Location: Rear Abutment - Ramp B - #1

LOG OF: Boring TR-60

Depth (ft)	Elev. (ft)	Blows per 6"	Recovery (in)	Sample No.	Drive	Press / Core	Hand Penetrometer (tsf)	GRADATION					STANDARD PENETRATION (N) Natural Moisture Content, % - PL ——— LL						
								% Aggregate	% C. Sand	% M. Sand	% F. Sand	% Silt		% Clay					
0.1	554.0																		
0.1	553.9																		
3.0	551.0	4 8 7 12		1															
5		4 4 4 12		2															
		3 2 2 9		3															
		3 2 3 13		4															
10	543.5	3 3 3 14		5															
		3 3 4 1		6															
		2 3 3 14		7															
18.0	536.0	1 1 2 17		8															
		4 3 3 16		9															
23.0	531.0	7 4 4 18		10															
25		3 6 4 18		11															
25.5	528.5	50/4 4		12															
28.0	526.0																		
30																			

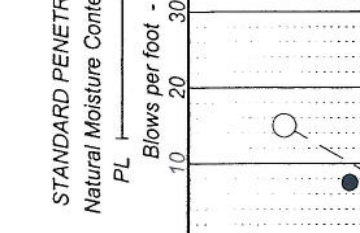

Location: Rear Abutment - Ramp B - #1

Date Drilled: 3-14-05

**LOG OF: Boring TR-60**

Depth (ft)	Elev. (ft)	Blows per 6"	Recovery (in)	Sample No.		Hand Penetrometer (tsf)	WATER OBSERVATIONS:	GRADATION												
				Drive	Press / Core			% Aggregate	% C. Sand	% M. Sand	% F. Sand	% Silt	% Clay							
30	524.0						Water seepage at: 18'-28' Water level at completion: 26.0' (Prior to coring) 19.0' (Including drill water)													
							<b>DESCRIPTION</b>													
							Medium hard black SHALE; moderately weathered, carbonaceous, laminated, highly fractured. @ 30.0'-32.3', clay seam. @ 32.3' hard. @ 33.2', 38.0'-38.2', clay seams. @ 39.4'-39.8', high angle fracture.													
							@ 39.9', Hard gray SANDSTONE.													
							Bottom of Boring - 40.0'													
35																				
40.0	514.0																			
45																				
50																				
55																				
60																				



Depth (ft)	Elev. (ft)	Blows per ft	Recovery (in)	Sample No.	Hand Penetrometer (tsf)	WATER OBSERVATIONS	GRADATION						STANDARD PENETRATION (N) Natural Moisture Content, % - ● Blows per foot - ○	
							% Aggregate	% C. Sand	% M. Sand	% F. Sand	% Silt	% Clay		
0	547.0													
5.5	541.5	2 2 2	2	1		FILL: Loose black SANDY SILT (A-4a), little gravel; organic; dry to damp.	14	20	--	26	28	12		
10	536.5	3 4 3	1	2	2.5	Very stiff light brown SILT AND CLAY (A-6a), trace fine to coarse sand, trace gravel; damp.	8	12	--	12	29	39		
15		1 3 5	12	4	2.25	@ 8.5', brown.	9	47	--	32	13			
20		1 2 2	13	5		Very loose brown COARSE AND FINE SAND (A-3a); moist.								
23.0	524.0	0 0 0	16	6		@ 10.5'-12.5', little clay								
25.0	522.0	0 0 1	18	7		@ 13.5', wet.								
		1 3 2	18	8		@ 18.0', very loose to loose.								
		1 1 3	18	9										
		50/3	3	10		Medium hard black SHALE; moderately weathered.								
						Hard black SHALE; fine grained, moderately weathered, carbonaceous, thinly bedded, moderately fractured, fissile.								
						@ 25.0'-25.2', 27.5'-27.6', 28.1'-28.2', 29.3'-30.0', high angle fractures								
30														

LOG OF: Boring TR-61 Location: Forward Abutment - Ramp B - #1 Date Drilled: 3-16-05

Depth (ft)	Elev. (ft)	Blows per 6"	Recovery (in)	Sample No.		Hand Penetrometer (tsf)	WATER OBSERVATIONS:	GRADATION						STANDARD PENETRATION (N) Natural Moisture Content, % - PL ——— LL Blows per foot - ○ 40				
				Drive	Press / Core			% Aggregate	% C. Sand	% M. Sand	% F. Sand	% Silt	% Clay					
30	517.0						Water seepage at: 13.5'-23.0'											
30.5	516.5						Water level at completion: 14.0' Prior to coring 9.0' Measured from inside the augers after coring											
35.0	512.0						<b>DESCRIPTION</b>  Hard gray SANDSTONE; fine to medium grained, slightly weathered, thinly to medium bedded. @ 31.2'-31.6', high angle fracture. 33.7'-33.9', clay seam.											
							Bottom of Boring - 35.0'											

