

Cleveland + Remington

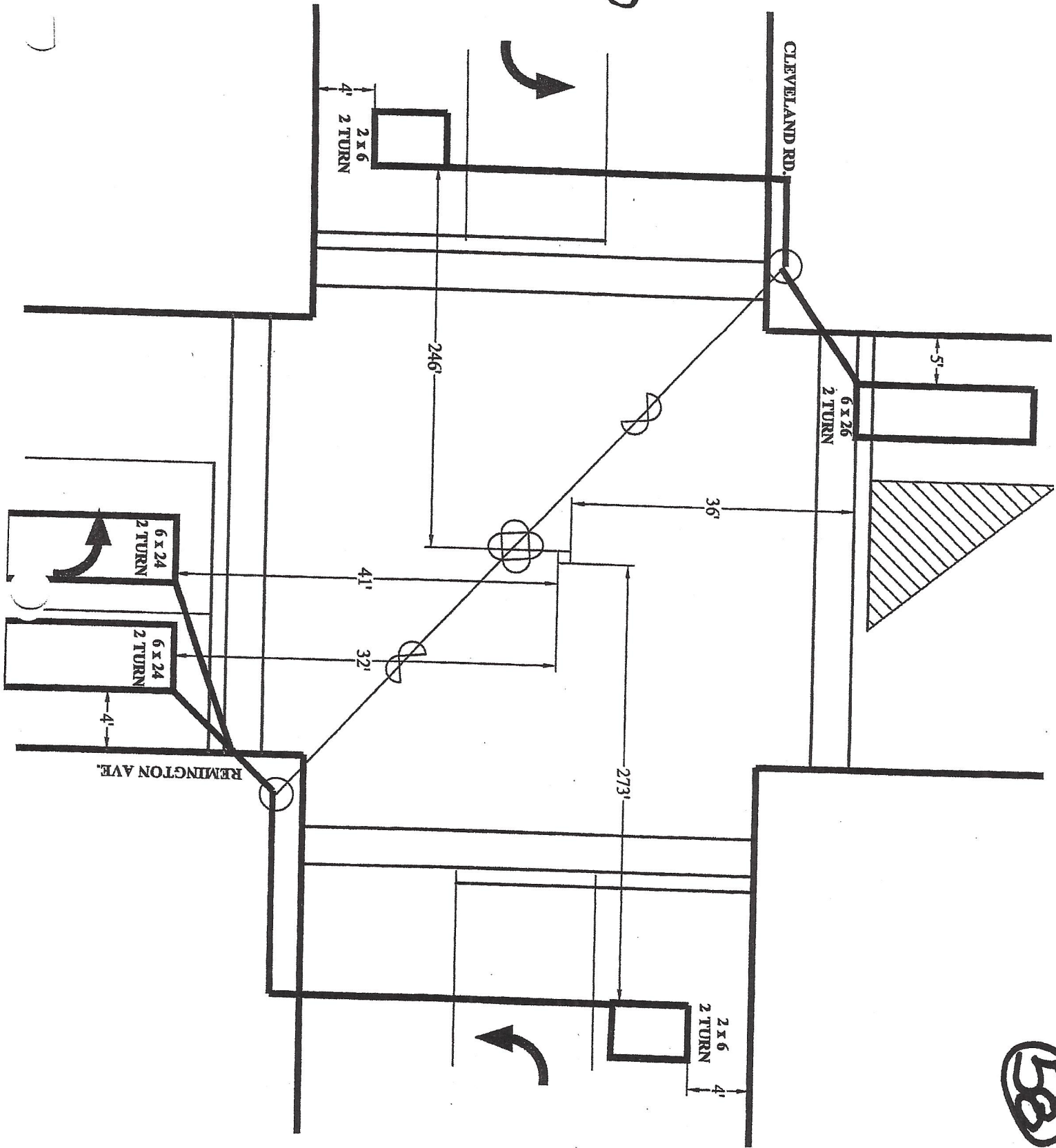

(58)

Cleveland + Harbour

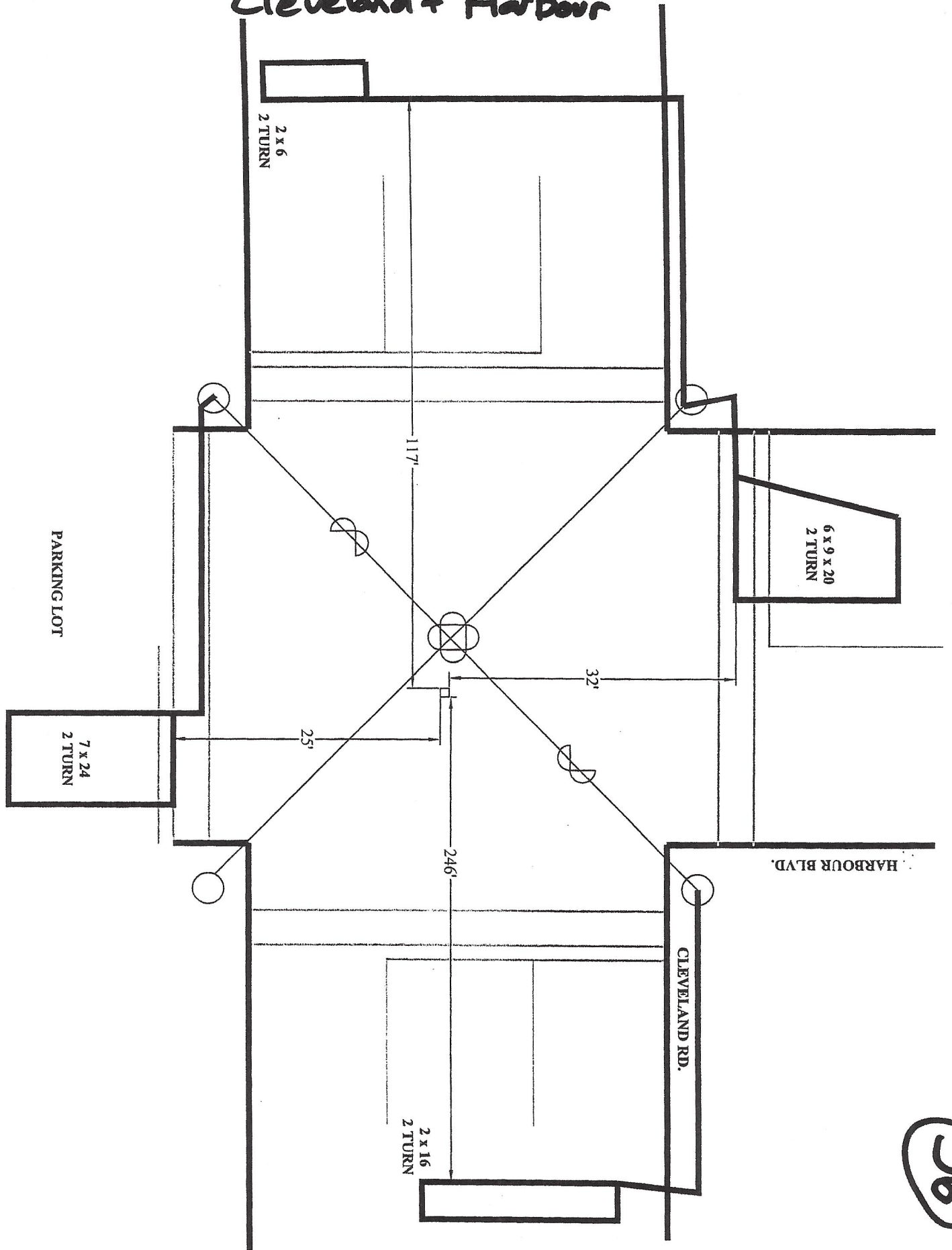

(56)



Cleveland + CP Drive

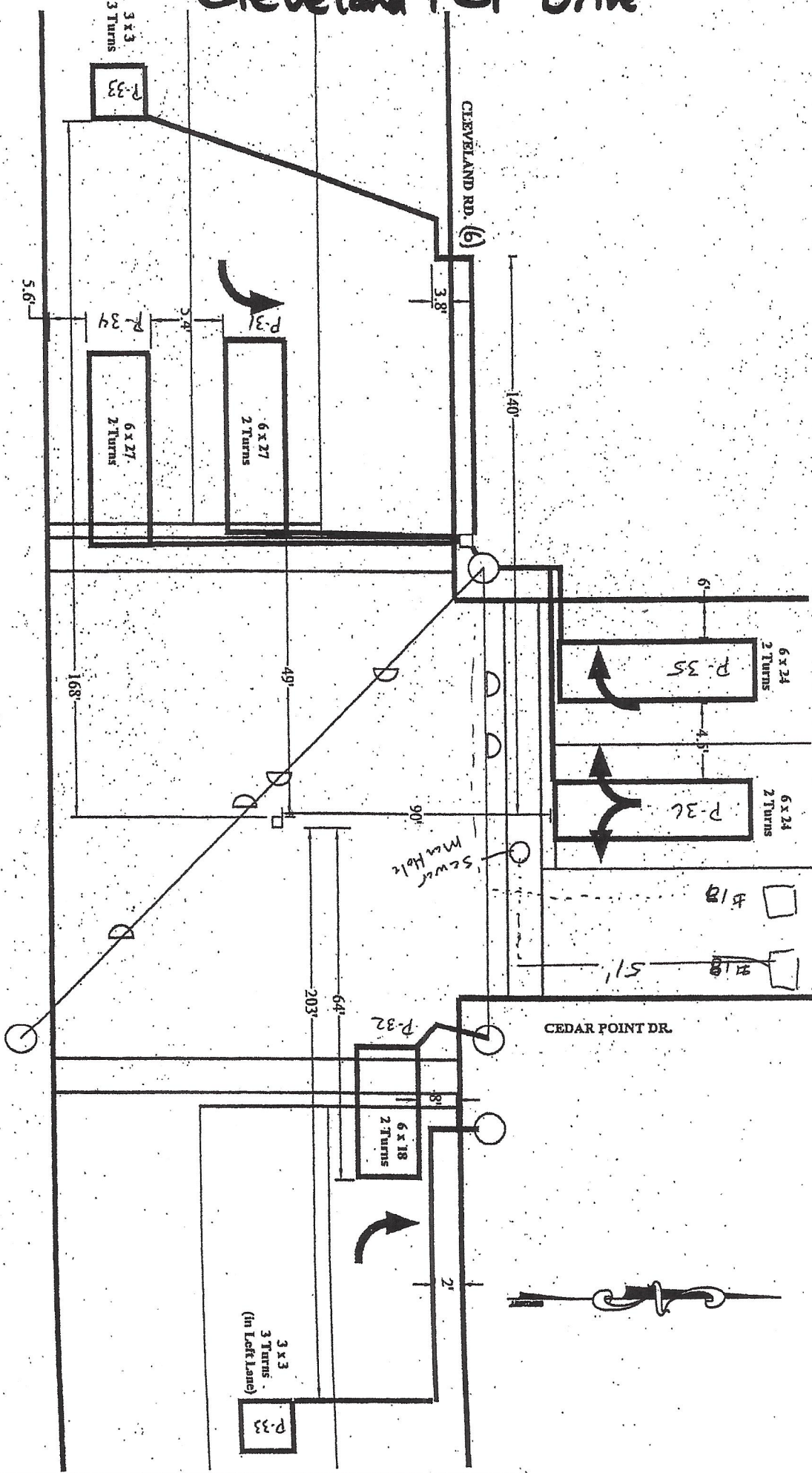

174

Cleveland + Cowdery

419-281-9463

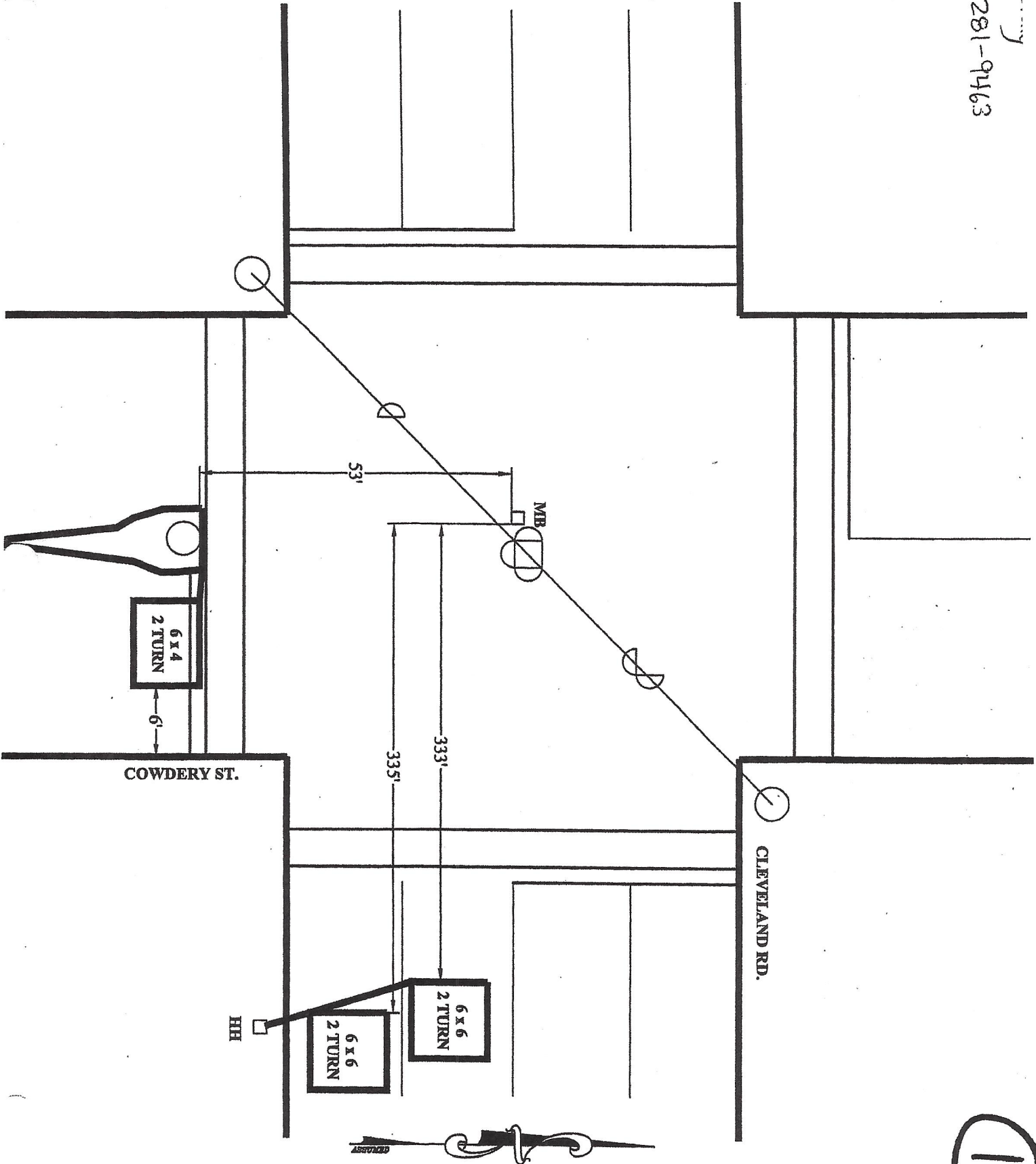

13

SCOTT + WARREN

SCOTT ST.

6 x 6
2 Turns

5'

M.B.

41'

40'

6 x 6
2 Turns

2'

WARREN ST.

(34)

ASSUMED



Monroe + Huron Ave + Warren St.

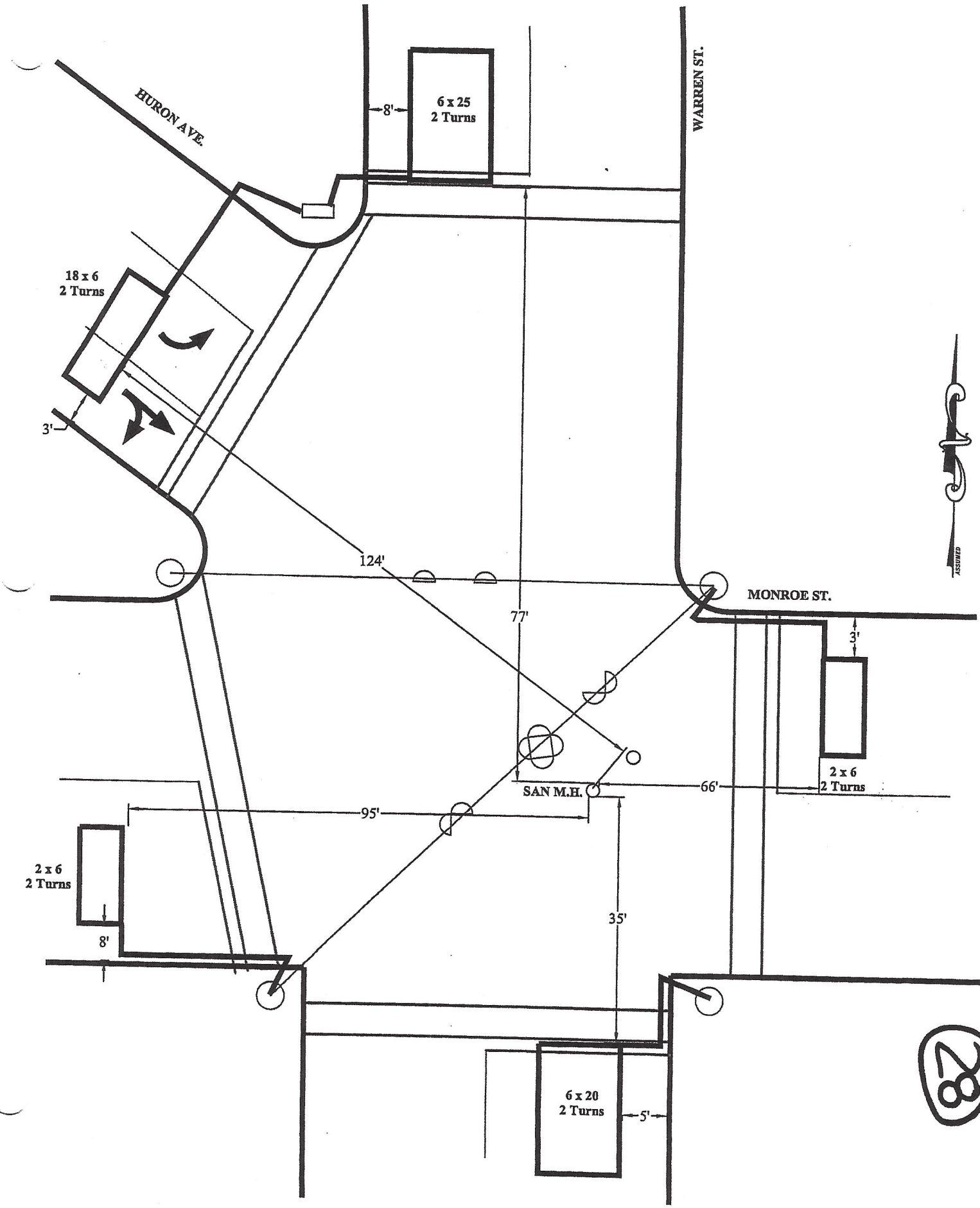

28

Washington + Wayne

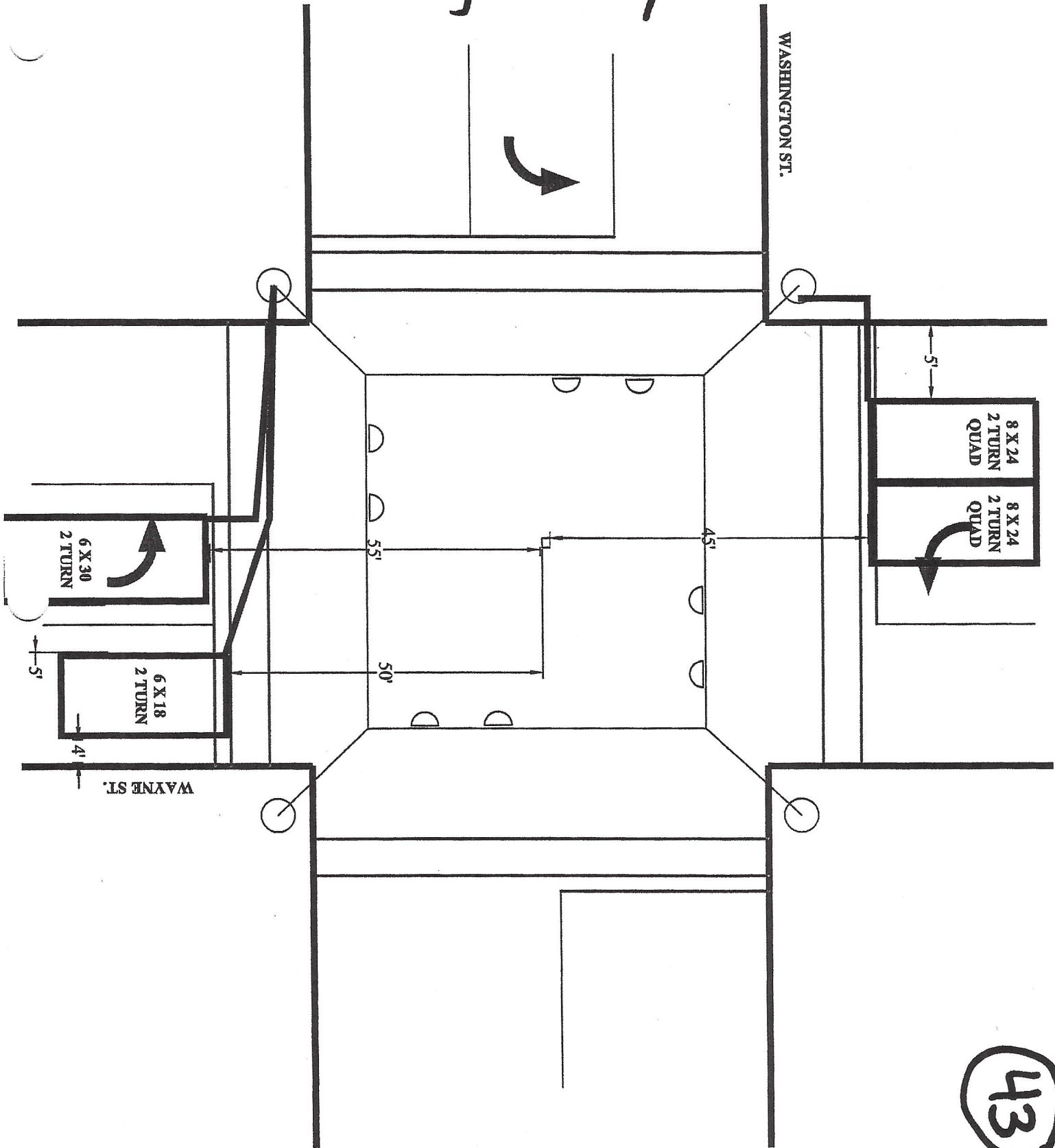

43



Washington + Columbus

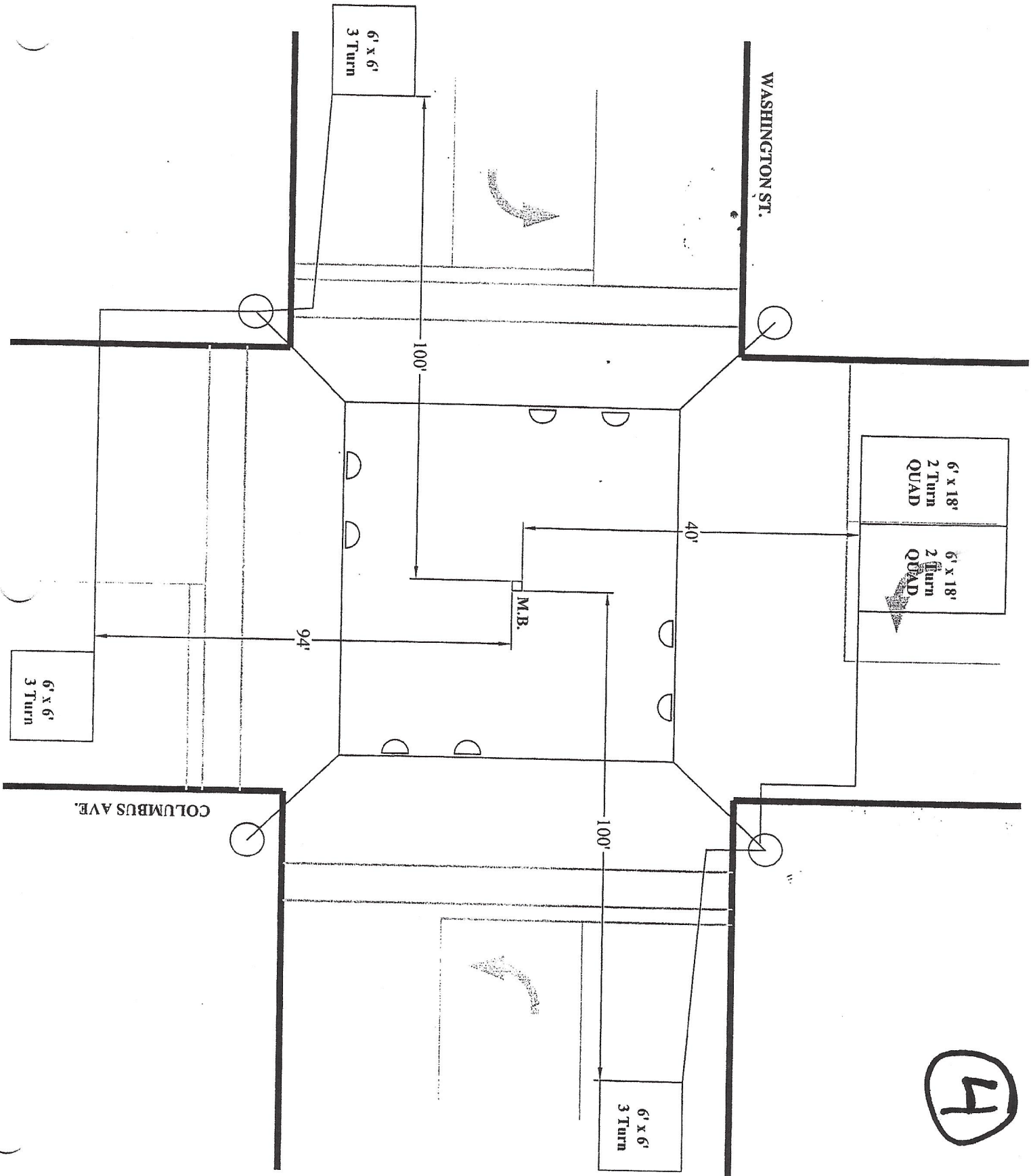

4



WASHINGTON + Jackson

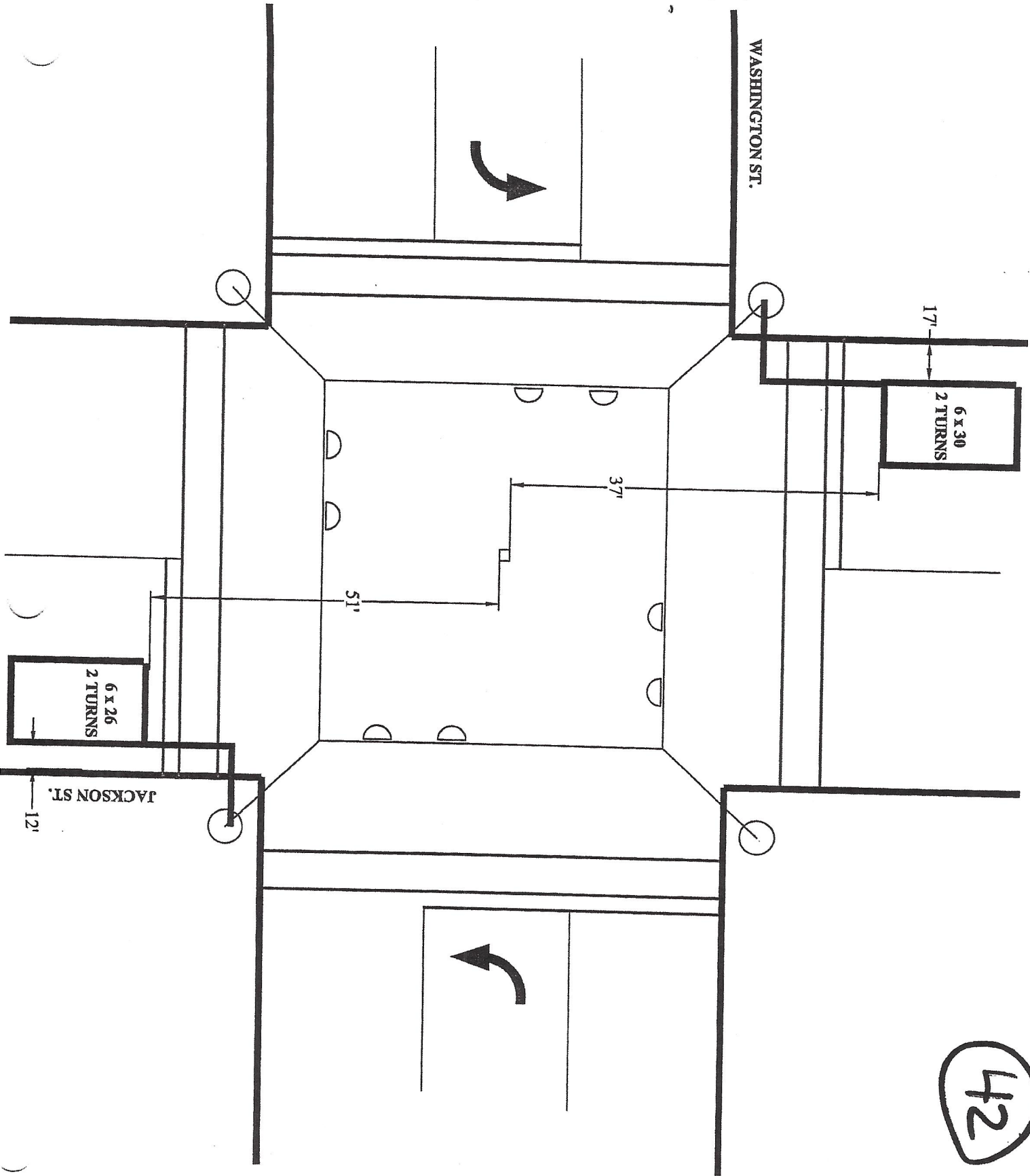

42



WASHINGTON + Decatur

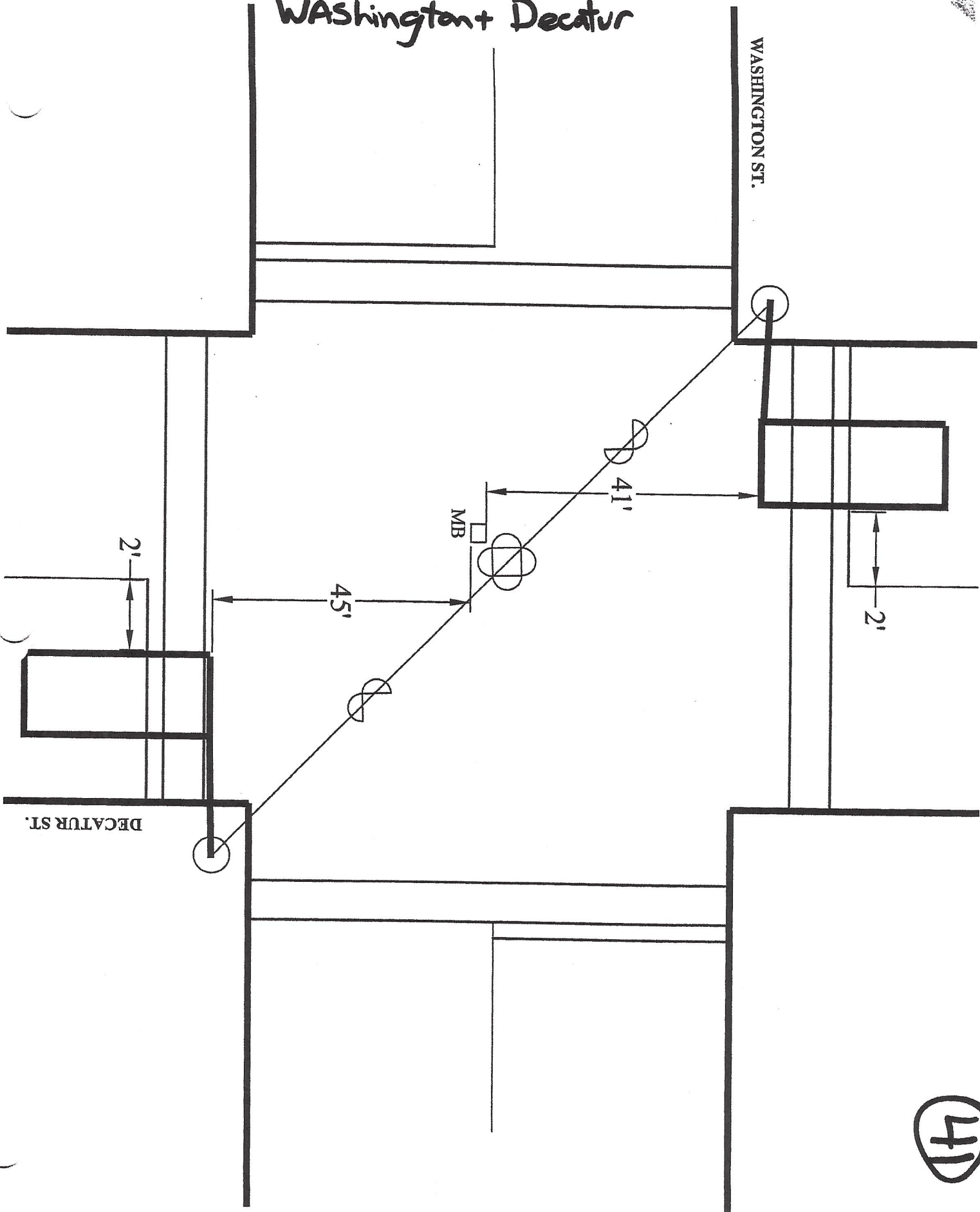

(41)



Washington Camp Shelby

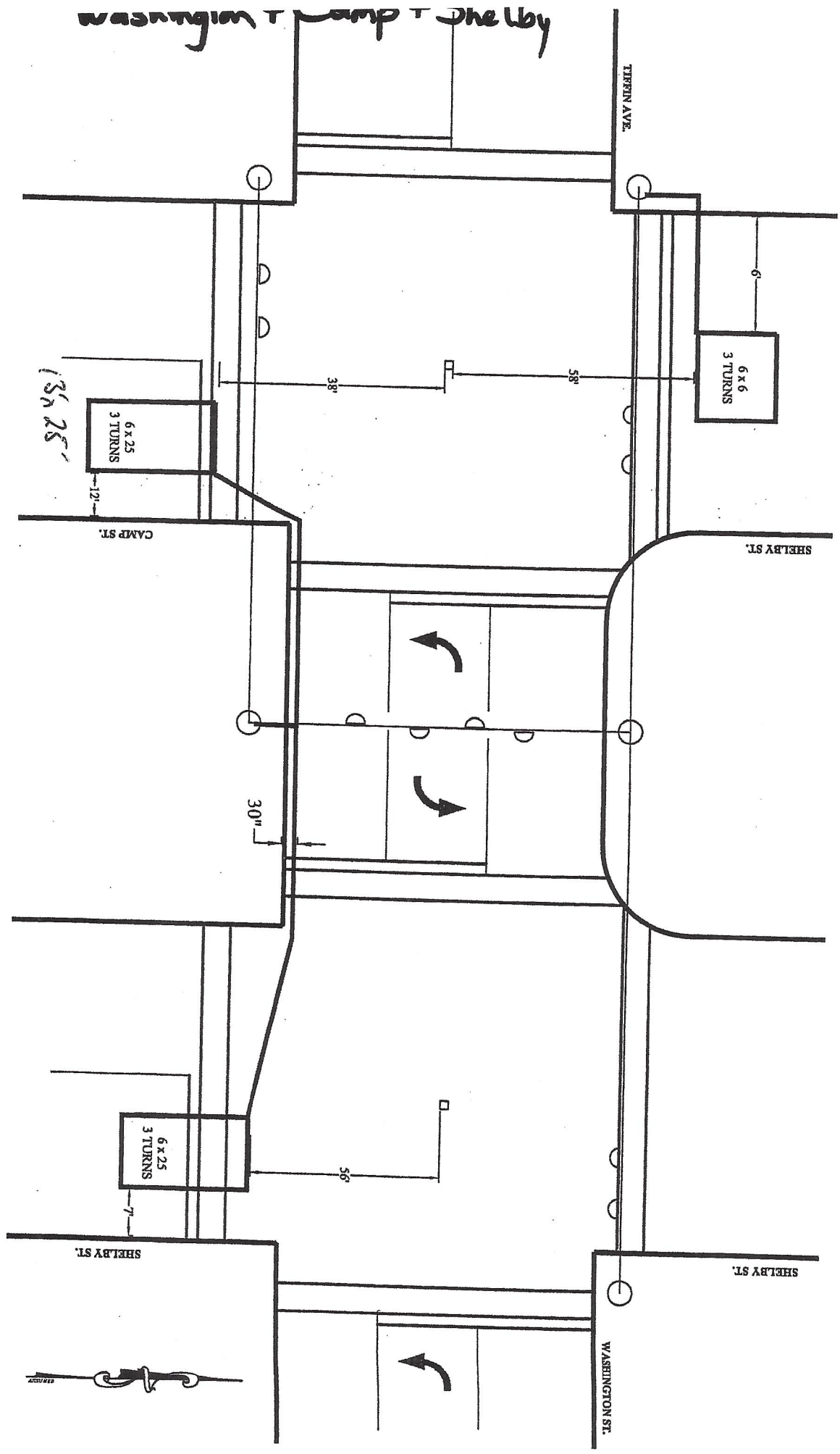

39

Tiffin + Monroe + Mills

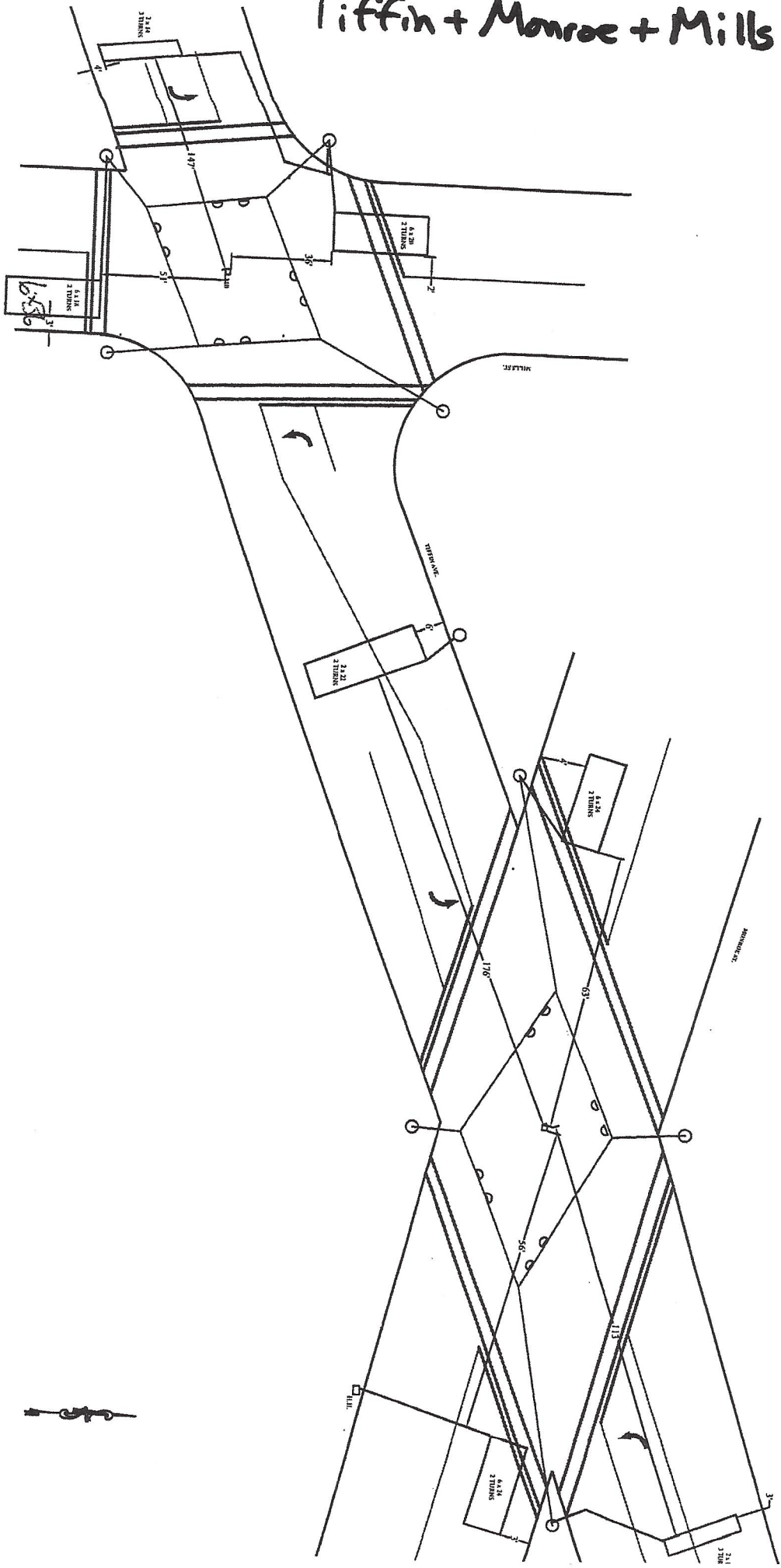

22

Tiffin Ave + Venice Rd / Sanford St.

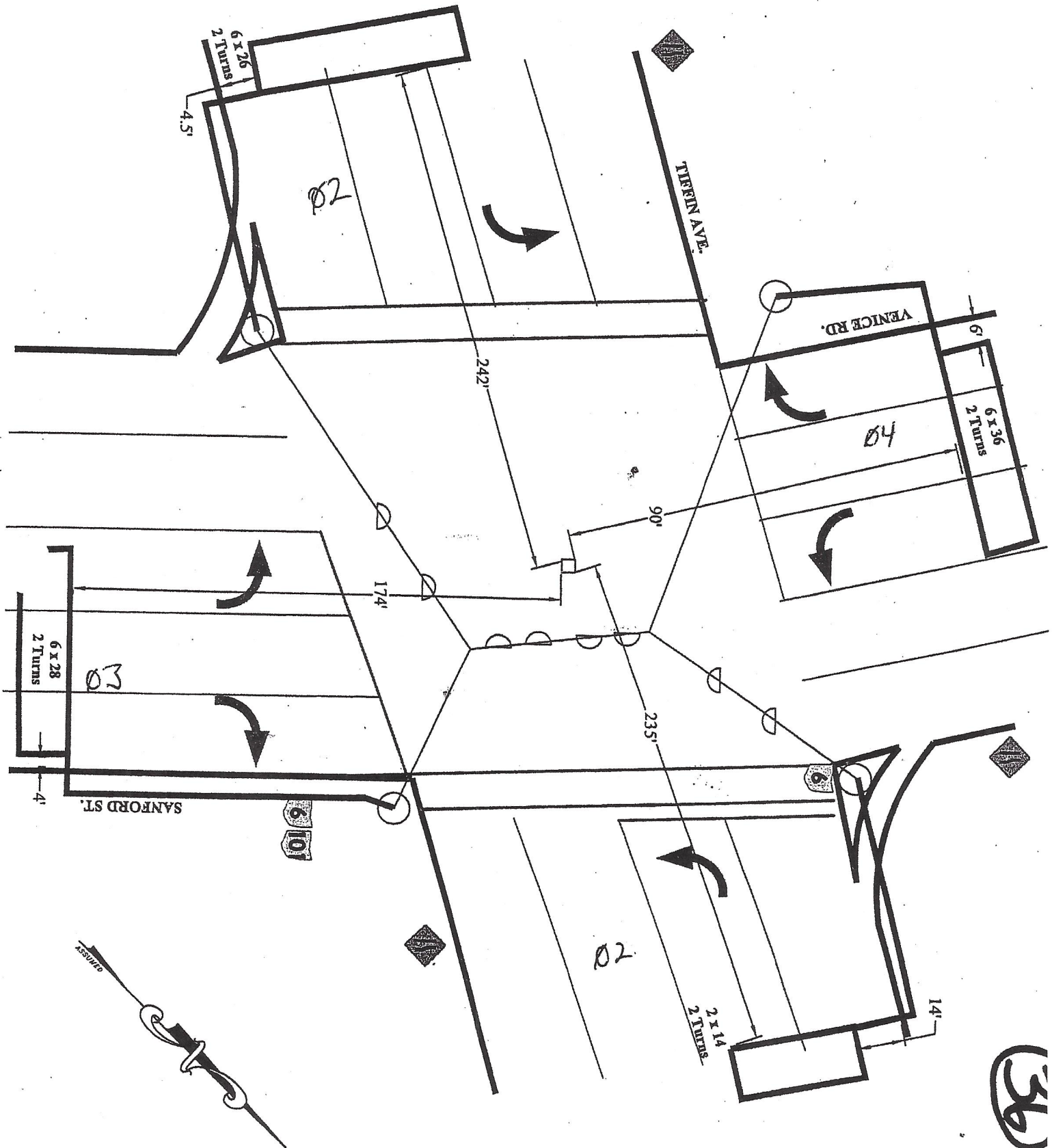

(36)

