



**GE Evolve™**

LED Roadway Lighting

ERL1-ERLH-ERL2



**current**  
powered by GE



# GE Evolve™ LED Roadway Lighting ERL1-ERLH-ERL2



The **Evolve** LED Roadway Luminaire is optimized for customers requiring a LED solution for local, collector and major roadways. GE's unique reflective optics are designed to optimize application efficiency and minimize glare. The modern design incorporates the heat sink directly into the unit for heat transfer to prolong LED life. This reliable unit has a 100,000 hour design life, significantly reducing maintenance needs and expense over the life of the fixture. This efficient solution lowers energy consumption compared to a traditional HID fixture for additional operating cost savings.

## Features:

- Optimized roadway photometric distributions
- **Evolve™** light engine consisting of reflective technology designed to optimize application efficiency and minimize glare
- 70 CRI at 2700K, 3000K and 4000K typical.
- -40°C to 50°C UL Ambient Typical.
- ULOR = 0 (zero uplight)
- Designed & Assembled in USA

## Applications:

- Local Roadways
- Collector Roadways
- Major Roadway/Streets



Compatible with **LightGrid™** Outdoor Wireless Control System

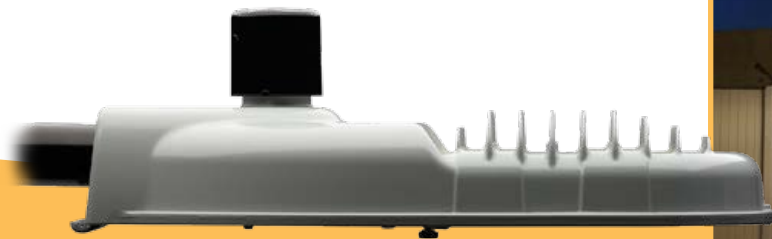

To learn more about **GE Evolve LED Roadway Lighting**, go to: [www.currentbyge.com](http://www.currentbyge.com)

# GE Evolve™

## LED Roadway Lighting

ERL1-ERLH-ERL2



Project name \_\_\_\_\_

Date \_\_\_\_\_

Type \_\_\_\_\_

## Typical Specifications: ERL1-ERLH-ERL2

### LED & Optical

- **Output Range:** 1900 – 30000 lm
- **Photometric Options:** Type II Narrow, Type II Wide, Type III, Type IV
- **System Efficacy:** 100 - 145 LPW
- **CCT:** 2700K, 3000K, 4000K; High brightness LEDs @ 70 CRI

### Lumen Maintenance Tables

Projected Lxx per IES TM-21 at 25°C for reference:

ERL1 LUMEN OUTPUT CODES	LXX(10K)@HOURS		
	25,000 HR	50,000 HR	100,000 HR
02,03,04,05,06	L96	L95	L91
07,08,09	L95	L91	L84
10	L89	L80	L64

ERLH LUMEN OUTPUT CODES	LXX(10K)@HOURS		
	25,000 HR	50,000 HR	100,000 HR
10, 11	L97	L96	L94
13, 14	L95	L93	L88
15, 16	L94	L91	L85

ERL2 LUMEN OUTPUT CODES	LXX(10K)@HOURS		
	25,000 HR	50,000 HR	100,000 HR
16, 18, 19, 21, 23	L96	L94	L91
25, 27, 28	L95	L93	L88
30	L95	L93	L87

**Note:** Projected Lxx based on LM80 (10,000 hour testing). DOE Lighting Facts Verification tolerances apply to initial luminous flux and lumen maintenance measurements.

### Electrical

- **Input Voltage:** 120-277 volt and 347-480 volt
- **Input Frequency:** 50/60Hz
- **Power Factor (PF)\*:** >90%
- **Total Harmonic Distortion (THD)\*:** <20%

\*Power factor and THD tolerance exceptions: ERL1 "02" Lumen output: PF and THD within tolerances above only at 120 volt. ERL1 "03" Lumen output: @120 volt PF~0.89; @ 480 volt THD~26% ERL1 "04" Lumen output: @480 volt THD~22%

### Ratings

- **Surge Protection:** per ANSI C136.2-2015: (Driver Internal):
  - 6kV/3kA "Basic: (120 Strikes)" - Standard on ERL1 (02-06)
  - 10kV/5kA "Enhanced: (40 Strikes)" - Standard on ERL1 (07 - 10), ERLH, ERL2
- **(Additional Separate Secondary SPD)**
  - 10kV/5kA "Enhanced: (40 Strikes)" - Option "R"
  - 20kV/10kA "Elevated" (40 Strikes) - Option "T"
- **Safety:** UL/cUL Listed. UL 1598 listed, suitable for wet locations (UL) (UL)
- **Environmental:** Compliant with the materials restrictions of RoHS
- **EMI:** Title 47 CFR Part 15 Class A
- **Vibration:** 3G per ANSI C136.31-2010
- LM-79 testing in accordance with IESNA Standards
- Std. Optical enclosure rated per ANSI C136.25-2009:
  - ERL1/ERLH/ERL2 = IP65, Optional: IP66

### Operating Temperature:

PRODUCT ID	LUMEN OUTPUT	AMBIENT READING
ERL1	02-10	-40°C to 50°C
ERLH	10-11, 13	-40°C to 50°C
ERLH	14-16	-40°C to 45°C
ERL2	16-28	-40°C to 50°C
ERL2	30	-40°C to 45°C

Delayed start may be experienced < -35°C

### Construction & Finish

- **Housing:**
  - Die Cast Enclosure
  - Casting-integral heat sink for maximum heat transfer
- **Lensing:** Impact resistant tempered glass, standard
- **Paint:** Corrosion resistant polyester powder painted, minimum 2.0 mil. thickness.
  - Standard Colors: Dark Bronze, Black, & Gray
  - RAL & custom colors available
  - Optional coastal finish available.
- **Weight:** 12.4lbs (5.6kg) – 24lbs (10.9kg)

### Warranty

- **System Warranty:** 5 Year Standard, 10 Year Optional

### Controls

- **Dimming:**
  - Standard: 0-10V; Optional: DALI (120-277V Only)
- **Sensors:**
  - Photo electric sensors (PE) available.
- LightGrid™ compatible

### Mounting

- Slipfitter with +/- 5 degree of adjustment for leveling.
- Integral die cast mounting pipe stop.
- Adjustable for 1.25 in. or 2 in. mounting pipe.

### Suggested HID Replacement Lumen Levels

- ~4,000–5,000 lumens to replace 100W HPS Cobra-head
- ~7,000–8,800 lumens to replace 150W HPS Cobra-head
- ~8,500–11,500 lumens to replace 200W HPS Cobra-head
- ~11,500–14,000 lumens to replace 250W HPS Cobra-head
- ~21,000–30,000 lumens to replace 400W HPS Cobra-head

**Note:** Actual replacement lumens may vary based upon mounting height, pole spacing, design criteria, etc.

PREVIOUS	DESCRIPTION	CURRENT	DESCRIPTION
A1, B1	Extra Narrow/Narrow Asymmetric	A3	Type II Narrow
C1, E1	Asymmetric Short/Medium	B3	Type II Wide
D1, G1	Asymmetric Forward/Extra Wide	C3	Type III
F1	Asymmetric Wide	D3	Type IV
		E3	Type II Enhanced Back Light

\*\*The information above is designed to provide a guideline to select the correct luminaire for a roadway application. The best and most accurate way to ensure the proper design is do a lighting layout Utilizing AGI.



Please refer to the DLC QPL website for the latest and most complete information. [www.designlights.org/QPL](http://www.designlights.org/QPL)



International Dark Sky Association listed. 2700K or 3000K must be selected to meet IDA certification and approval.

# GE Evolve™ LED Roadway Lighting

ERL1-ERLH-ERL2



Project name \_\_\_\_\_  
Date \_\_\_\_\_  
Type \_\_\_\_\_

## ERL1

PROD. ID	VOLTAGE	LUMEN OUTPUT	DISTRIBUTION*	CCT	CONTROLS	COLOR	OPTIONS
<b>E</b> = Evolve <b>R</b> = Roadway <b>L</b> = Local <b>1</b> = Single Module	<b>0</b> = 120-277V* <b>1</b> = 120 <b>2</b> = 208 <b>3</b> = 240 <b>4</b> = 277 <b>5</b> = 480 <b>D</b> = 347 <b>H</b> = 347-480*#  * Not available with Fusing. Must choose a discrete voltage with F option. # Not available with E controls option.	<b>02*</b> <b>03&lt;</b> <b>04&lt;</b> <b>05&lt;</b> <b>06</b> <b>07</b> <b>08</b> <b>09</b> <b>10</b>  See Table *120V only, not compatible with 0-10V dimming. < See Note Under Controls Column	<b>A3</b> = Type II Narrow <b>B3</b> = Type II Wide <b>C3</b> = Type III <b>D3</b> = Type IV <b>E3</b> = Type II Enhanced Back Light  See Table  *Nominal IES Type classing subject to typical variation, individual units may differ.	<b>27</b> = 2700K < <b>30</b> = 3000K <b>40</b> = 4000K  < Select 2700K or 3000K CCT for IES approved units.	<b>A</b> = ANSI C136.41 7-pin <b>D</b> = ANSI C136.41 7-pin with Shorting Cap <b>E</b> = ANSI C136.41 7-pin with non-Dimming PE Control.*  *PE Control Only available for 120-277V or 480V Discrete. Not available for 347-480V or 347V Discrete.  < If dimming the 03 - 05 lumen output using a control supplied from a source other than GE call 1-888-694-3533, then select Option 2 at the prompt for assistance.  <b>NOTE:</b> Dimming controls wired for 0-10V standard unless DALI option "U" requested.	<b>GRAY</b> = Gray <b>BLCK</b> = Black <b>DKBKZ</b> = Dark Bronze	<b>A</b> = 4 Bolt Slipfitter † <b>F</b> = Fusing <b>G</b> = Internal Bubble Level <b>I</b> = IP66 Optical <b>L</b> = Tool-Less Entry <b>R</b> = Secondary 10kV/5kA SPD <b>T</b> = Secondary 20kV/10kA SPD <b>U</b> = DALI Programmable +^ <b>V1</b> = Variable Output via Field Adjustable Module** <b>X</b> = Single Package # <b>Y</b> = Coastal Finish* <b>XXX</b> = Special Options  † Contact manufacturer for Lead-Time. # "X" option provides single pack box per fixture. Std Packaging = 20 units per Magna pak container. * Recommended for installations within 750 ft. from the coast. Contact Factory for Lead-Time. ^ Compatible with LightGrid 2.0 nodes. † Not available in 347V, 480V or 347-480V for Lumen Output Levels 07, 08, 09, and 10. ** Not available with DALI (U) option.

LUMEN OUTPUT	DISTRIBUTION	TYPICAL INITIAL LUMENS			TYPICAL SYSTEM WATTAGE		BUG RATING			IES FILE NUMBER					
		4000K	3000K	2700K	120-277V	347-480V	4000K	3000K	2700K	4000K		3000K		2700K	
										120-277V	347-480V	120-277V	347-480V	120-277V	347-480V
02	A3	2000	1900	1900	14	N/A	B1-U0-G1	B1-U0-G1	B1-U0-G1	ERL1_02A340 -120VIES	N/A	ERL1_02A330 -120VIES	N/A	ERL1_02A327 -120VIES	N/A
	B3						B1-U0-G1	B1-U0-G1	ERL1_02B340 -120VIES	N/A	ERL1_02B330 -120VIES	N/A	ERL1_02B327 -120VIES	N/A	
	C3						B1-U0-G1	B1-U0-G1	ERL1_02C340 -120VIES	N/A	ERL1_02C330 -120VIES	N/A	ERL1_02C327 -120VIES	N/A	
	D3						B0-U0-G1	B0-U0-G1	ERL1_02D340 -120VIES	N/A	ERL1_02D330 -120VIES	N/A	ERL1_02D327 -120VIES	N/A	
	E3						B1-U0-G1	B1-U0-G1	ERL1_02E340 -120VIES	N/A	ERL1_02E330 -120VIES	N/A	ERL1_02E327 -120VIES	N/A	
03	A3	3000	2900	2800	22	26	B1-U0-G1	B1-U0-G1	B1-U0-G1	ERL1_03A340 -120-277VIES	ERL1_03A340 -347-480VIES	ERL1_03A330 -120-277VIES	ERL1_03A330 -347-480VIES	ERL1_03A327 -120-277VIES	ERL1_03A327 -347-480VIES
	B3						B1-U0-G1	B1-U0-G1	ERL1_03B340 -120-277VIES	ERL1_03B340 -347-480VIES	ERL1_03B330 -120-277VIES	ERL1_03B330 -347-480VIES	ERL1_03B327 -120-277VIES	ERL1_03B327 -347-480VIES	
	C3						B1-U0-G1	B1-U0-G1	ERL1_03C340 -120-277VIES	ERL1_03C340 -347-480VIES	ERL1_03C330 -120-277VIES	ERL1_03C330 -347-480VIES	ERL1_03C327 -120-277VIES	ERL1_03C327 -347-480VIES	
	D3						B1-U0-G1	B1-U0-G1	ERL1_03D340 -120-277VIES	ERL1_03D340 -347-480VIES	ERL1_03D330 -120-277VIES	ERL1_03D330 -347-480VIES	ERL1_03D327 -120-277VIES	ERL1_03D327 -347-480VIES	
	E3						B1-U0-G1	B1-U0-G1	ERL1_03E340 -120-277VIES	ERL1_03E340 -347-480VIES	ERL1_03E330 -120-277VIES	ERL1_03E330 -347-480VIES	ERL1_03E327 -120-277VIES	ERL1_03E327 -347-480VIES	
04	A3	4000	3900	3800	31	34	B1-U0-G1	B1-U0-G1	B1-U0-G1	ERL1_04A340 -120-277VIES	ERL1_04A340 -347-480VIES	ERL1_04A330 -120-277VIES	ERL1_04A330 -347-480VIES	ERL1_04A327 -120-277VIES	ERL1_04A327 -347-480VIES
	B3						B1-U0-G1	B1-U0-G1	ERL1_04B340 -120-277VIES	ERL1_04B340 -347-480VIES	ERL1_04B330 -120-277VIES	ERL1_04B330 -347-480VIES	ERL1_04B327 -120-277VIES	ERL1_04B327 -347-480VIES	
	C3						B1-U0-G1	B1-U0-G1	ERL1_04C340 -120-277VIES	ERL1_04C340 -347-480VIES	ERL1_04C330 -120-277VIES	ERL1_04C330 -347-480VIES	ERL1_04C327 -120-277VIES	ERL1_04C327 -347-480VIES	
	D3						B1-U0-G1	B1-U0-G1	ERL1_04D340 -120-277VIES	ERL1_04D340 -347-480VIES	ERL1_04D330 -120-277VIES	ERL1_04D330 -347-480VIES	ERL1_04D327 -120-277VIES	ERL1_04D327 -347-480VIES	
	E3						B1-U0-G1	B1-U0-G1	ERL1_04E340 -120-277VIES	ERL1_04E340 -347-480VIES	ERL1_04E330 -120-277VIES	ERL1_04E330 -347-480VIES	ERL1_04E327 -120-277VIES	ERL1_04E327 -347-480VIES	
05	A3	5000	4900	4700	39	43	B1-U0-G1	B1-U0-G1	B1-U0-G1	ERL1_05A340 -120-277VIES	ERL1_05A340 -347-480VIES	ERL1_05A330 -120-277VIES	ERL1_05A330 -347-480VIES	ERL1_05A327 -120-277VIES	ERL1_05A327 -347-480VIES
	B3						B1-U0-G1	B1-U0-G1	ERL1_05B340 -120-277VIES	ERL1_05B340 -347-480VIES	ERL1_05B330 -120-277VIES	ERL1_05B330 -347-480VIES	ERL1_05B327 -120-277VIES	ERL1_05B327 -347-480VIES	
	C3						B1-U0-G2	B1-U0-G2	ERL1_05C340 -120-277VIES	ERL1_05C340 -347-480VIES	ERL1_05C330 -120-277VIES	ERL1_05C330 -347-480VIES	ERL1_05C327 -120-277VIES	ERL1_05C327 -347-480VIES	
	D3						B1-U0-G1	B1-U0-G1	ERL1_05D340 -120-277VIES	ERL1_05D340 -347-480VIES	ERL1_05D330 -120-277VIES	ERL1_05D330 -347-480VIES	ERL1_05D327 -120-277VIES	ERL1_05D327 -347-480VIES	
	E3						B1-U0-G1	B1-U0-G1	ERL1_05E340 -120-277VIES	ERL1_05E340 -347-480VIES	ERL1_05E330 -120-277VIES	ERL1_05E330 -347-480VIES	ERL1_05E327 -120-277VIES	ERL1_05E327 -347-480VIES	
06	A3	6000	5800	5700	47	52	B2-U0-G2	B2-U0-G2	B2-U0-G2	ERL1_06A340 -120-277VIES	ERL1_06A340 -347-480VIES	ERL1_06A330 -120-277VIES	ERL1_06A330 -347-480VIES	ERL1_06A327 -120-277VIES	ERL1_06A327 -347-480VIES
	B3						B1-U0-G2	B1-U0-G2	ERL1_06B340 -120-277VIES	ERL1_06B340 -347-480VIES	ERL1_06B330 -120-277VIES	ERL1_06B330 -347-480VIES	ERL1_06B327 -120-277VIES	ERL1_06B327 -347-480VIES	
	C3						B1-U0-G2	B1-U0-G2	ERL1_06C340 -120-277VIES	ERL1_06C340 -347-480VIES	ERL1_06C330 -120-277VIES	ERL1_06C330 -347-480VIES	ERL1_06C327 -120-277VIES	ERL1_06C327 -347-480VIES	
	D3						B1-U0-G2	B1-U0-G2	ERL1_06D340 -120-277VIES	ERL1_06D340 -347-480VIES	ERL1_06D330 -120-277VIES	ERL1_06D330 -347-480VIES	ERL1_06D327 -120-277VIES	ERL1_06D327 -347-480VIES	
	E3						B2-U0-G2	B2-U0-G2	ERL1_06E340 -120-277VIES	ERL1_06E340 -347-480VIES	ERL1_06E330 -120-277VIES	ERL1_06E330 -347-480VIES	ERL1_06E327 -120-277VIES	ERL1_06E327 -347-480VIES	
07	A3	7000	6800	6600	58	B2-U0-G2	B2-U0-G2	B2-U0-G2	ERL1_07A340 .IES	ERL1_07A340 .IES	ERL1_07A330 .IES	ERL1_07A330 .IES	ERL1_07A327 .IES	ERL1_07A327 .IES	
	B3					B1-U0-G2	B1-U0-G2	ERL1_07B340 .IES	ERL1_07B340 .IES	ERL1_07B330 .IES	ERL1_07B330 .IES	ERL1_07B327 .IES	ERL1_07B327 .IES		
	C3					B1-U0-G2	B1-U0-G2	ERL1_07C340 .IES	ERL1_07C340 .IES	ERL1_07C330 .IES	ERL1_07C330 .IES	ERL1_07C327 .IES	ERL1_07C327 .IES		
	D3					B1-U0-G2	B1-U0-G2	ERL1_07D340 .IES	ERL1_07D340 .IES	ERL1_07D330 .IES	ERL1_07D330 .IES	ERL1_07D327 .IES	ERL1_07D327 .IES		
	E3					B2-U0-G2	B2-U0-G2	ERL1_07E340 .IES	ERL1_07E340 .IES	ERL1_07E330 .IES	ERL1_07E330 .IES	ERL1_07E327 .IES	ERL1_07E327 .IES		
08	A3	8000	7800	7600	71	B2-U0-G2	B2-U0-G2	B2-U0-G2	ERL1_08A340 .IES	ERL1_08A340 .IES	ERL1_08A330 .IES	ERL1_08A330 .IES	ERL1_08A327 .IES	ERL1_08A327 .IES	
	B3					B2-U0-G2	B2-U0-G2	ERL1_08B340 .IES	ERL1_08B340 .IES	ERL1_08B330 .IES	ERL1_08B330 .IES	ERL1_08B327 .IES	ERL1_08B327 .IES		
	C3					B1-U0-G2	B1-U0-G2	ERL1_08C340 .IES	ERL1_08C340 .IES	ERL1_08C330 .IES	ERL1_08C330 .IES	ERL1_08C327 .IES	ERL1_08C327 .IES		
	D3					B1-U0-G2	B1-U0-G2	ERL1_08D340 .IES	ERL1_08D340 .IES	ERL1_08D330 .IES	ERL1_08D330 .IES	ERL1_08D327 .IES	ERL1_08D327 .IES		
	E3					B2-U0-G2	B2-U0-G2	ERL1_08E340 .IES	ERL1_08E340 .IES	ERL1_08E330 .IES	ERL1_08E330 .IES	ERL1_08E327 .IES	ERL1_08E327 .IES		
09	A3	9000	8800	8500	84	B2-U0-G2	B2-U0-G2	B2-U0-G2	ERL1_09A340 .IES	ERL1_09A340 .IES	ERL1_09A330 .IES	ERL1_09A330 .IES	ERL1_09A327 .IES	ERL1_09A327 .IES	
	B3					B2-U0-G2	B2-U0-G2	ERL1_09B340 .IES	ERL1_09B340 .IES	ERL1_09B330 .IES	ERL1_09B330 .IES	ERL1_09B327 .IES	ERL1_09B327 .IES		
	C3					B1-U0-G2	B1-U0-G2	ERL1_09C340 .IES	ERL1_09C340 .IES	ERL1_09C330 .IES	ERL1_09C330 .IES	ERL1_09C327 .IES	ERL1_09C327 .IES		
	D3					B1-U0-G2	B1-U0-G2	ERL1_09D340 .IES	ERL1_09D340 .IES	ERL1_09D330 .IES	ERL1_09D330 .IES	ERL1_09D327 .IES	ERL1_09D327 .IES		
	E3					B2-U0-G2	B2-U0-G2	ERL1_09E340 .IES	ERL1_09E340 .IES	ERL1_09E330 .IES	ERL1_09E330 .IES	ERL1_09E327 .IES	ERL1_09E327 .IES		
10	A3	9800	9600	9250	97	B2-U0-G2	B2-U0-G2	B2-U0-G2	ERL1_10A340 .IES	ERL1_10A340 .IES	ERL1_10A330 .IES	ERL1_10A330 .IES	ERL1_10A327 .IES	ERL1_10A327 .IES	
	B3					B2-U0-G2	B2-U0-G2	ERL1_10B340 .IES	ERL1_10B340 .IES	ERL1_10B330 .IES	ERL1_10B330 .IES	ERL1_10B327 .IES	ERL1_10B327 .IES		
	C3					B2-U0-G2	B2-U0-G2	ERL1_10C340 .IES	ERL1_10C340 .IES	ERL1_10C330 .IES	ERL1_10C330 .IES	ERL1_10C327 .IES	ERL1_10C327 .IES		
	D3					B1-U0-G2	B1-U0-G2	ERL1_10D340 .IES	ERL1_10D340 .IES	ERL1_10D330 .IES	ERL1_10D330 .IES	ERL1_10D327 .IES	ERL1_10D327 .IES		
	E3					B2-U0-G2	B2-U0-G2	ERL1_10E340 .IES	ERL1_10E340 .IES	ERL1_10E330 .IES	ERL1_10E330 .IES	ERL1_10E327 .IES	ERL1_10E327 .IES		



# Photometrics:

## Evolve™ LED Streetlight (ERL1)

### ERL1

Type II Narrow  
(05A340)

5,000 Lumens  
4000K  
ERL1\_05A340\_\_IES

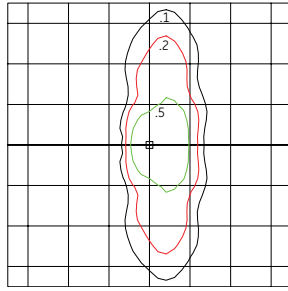

Grid Distance in Units of Mounting Height at 30'  
Initial Footcandle Values at Grade

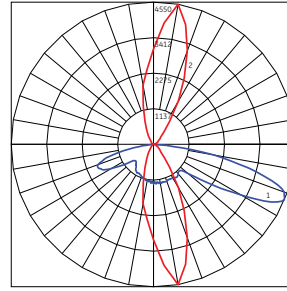

— Vertical plane through horizontal angle of Max. Cd at 80°  
— Horizontal cone through vertical angle of Max. Cd at 67°

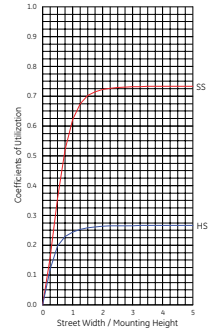

### ERL1

Type II Wide  
(05B340)

5,000 Lumens  
4000K  
ERL1\_05B340\_\_IES

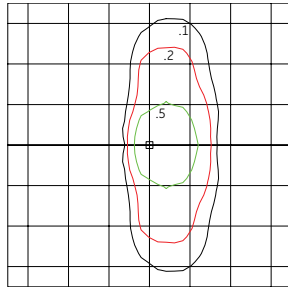

Grid Distance in Units of Mounting Height at 30'  
Initial Footcandle Values at Grade

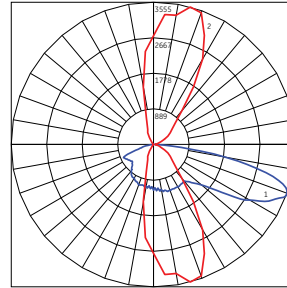

— Vertical plane through horizontal angle of Max. Cd at 75°  
— Horizontal cone through vertical angle of Max. Cd at 69°

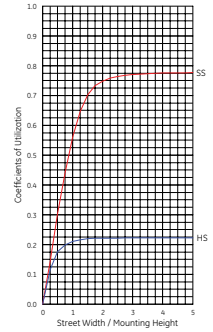

### ERL1

Type III  
(05C340)

5,000 Lumens  
4000K  
ERL1\_05C340\_\_IES

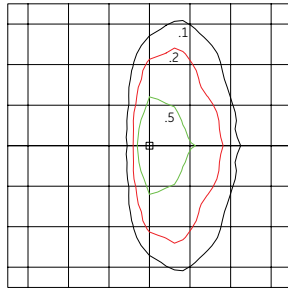

Grid Distance in Units of Mounting Height at 30'  
Initial Footcandle Values at Grade

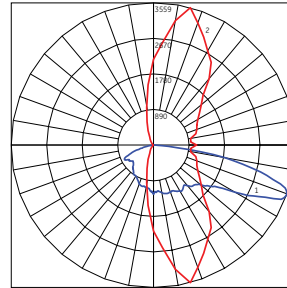

— Vertical plane through horizontal angle of Max. Cd at 75°  
— Horizontal cone through vertical angle of Max. Cd at 70°

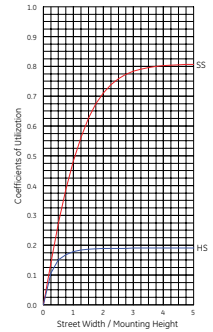

### ERL1

Type IV  
(05D340)

5,000 Lumens  
4000K  
ERL1\_(05D340)\_\_IES

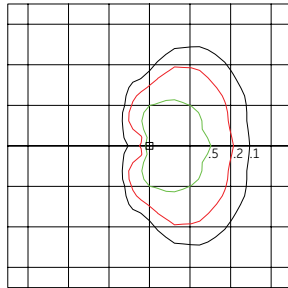

Grid Distance in Units of Mounting Height at 30'  
Initial Footcandle Values at Grade

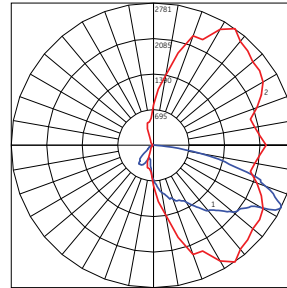

— Vertical plane through horizontal angle of Max. Cd at 55°  
— Horizontal cone through vertical angle of Max. Cd at 64°

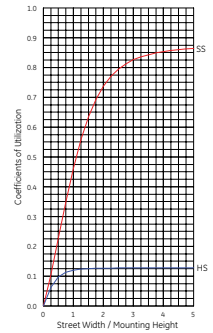

### ERL1

Type II Enhanced Back Light  
(05E340)

5,000 Lumens  
4000K  
ERL1\_(05E340)\_\_IES

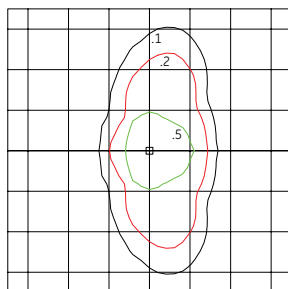

Grid Distance in Units of Mounting Height at 30'  
Initial Footcandle Values at Grade

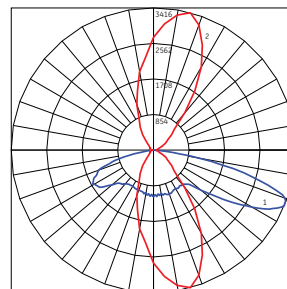

— Vertical plane through horizontal angle of Max. Cd at 75°  
— Horizontal cone through vertical angle of Max. Cd at 67°

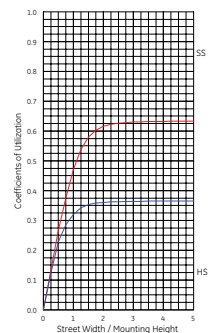



Project name \_\_\_\_\_  
Date \_\_\_\_\_  
Type \_\_\_\_\_

**E R L H**

PROD. ID	VOLTAGE	LUMEN OUTPUT	DISTRIBUTION*	CCT	CONTROLS	COLOR	OPTIONS
<b>E</b> = Evolve <b>R</b> = Roadway <b>L</b> = Local <b>H</b> = High Output	<b>0</b> = 120-277V* <b>1</b> = 120 <b>2</b> = 208 <b>3</b> = 240 <b>4</b> = 277 <b>5</b> = 480 <b>D</b> = 347 <b>H</b> = 347-480*#  * Not available with Fusing. Must choose a discrete voltage with F option. # Not available with E controls option.	<b>10</b> <b>11</b> <b>13</b> <b>14</b> <b>15</b> <b>16</b>  See Table	<b>A3</b> = Type II Narrow <b>B3</b> = Type II Wide <b>C3</b> = Type III <b>D3</b> = Type IV <b>E3</b> = Type II Enhanced Back Light  See Table  *Nominal IES Type classing subject to typical variation, individual units may differ.	<b>30</b> = 3000K< <b>40</b> = 4000K  < Select 3000K CCT for IDA approved units.	<b>A</b> = ANSI C136.41 7-pin <b>D</b> = ANSI C136.41 7-pin with Shorting Cap <b>E</b> = ANSI C136.41 7-pin with non-Dimming PE Control.*  *PE Control Only available for 120-277V or 480V Discrete. Not available for 347-480V or 347V Discrete.  <b>NOTE:</b> Dimming controls wired for 0-10V standard unless DALI option "U" requested.	<b>GRAY</b> = Gray <b>BLCK</b> = Black <b>DKBZ</b> = Dark Bronze	<b>A</b> = 4 Bolt Slipfitter † <b>F</b> = Fusing <b>G</b> = Internal Bubble Level <b>I</b> = IP66 Optical <b>L</b> = Tool-Less Entry <b>R</b> = Secondary 10kV/5kA SPD <b>T</b> = Secondary 20kV/10kA SPD <b>U</b> = DALI Programmable +^ <b>V1</b> = Variable Output via Field Adjustable Module** <b>X</b> = Single Package # <b>Y</b> = Coastal Finish* <b>XXX</b> = Special Options  † Contact manufacturer for Lead-Time. # "X" option provides single pack box per fixture. Std Packaging = 20 units per Magna pak container. * Recommended for installations within 750 ft. from the coast. Contact Factory for Lead-Time. + Compatible with LightGrid 2.0 nodes. ^ Not available in 347V, 480V or 347-480V. ** Not available with DALI (U) option.

LUMEN OUTPUT	DISTRIBUTION	TYPICAL INITIAL LUMENS		TYPICAL SYSTEM WATTAGE		BUG RATING		IES FILE NUMBER			
		4000K	3000K	120-277V	347-480V	4000K	3000K	4000K	3000K		
10	A3	10000	9600	82	82	B2-U0-G2	B2-U0-G2	ERLH_10A340	IES	ERLH_10A330	IES
	B3					B2-U0-G2	B2-U0-G2	ERLH_10B340	IES	ERLH_10B330	IES
	C3					B2-U0-G3	B2-U0-G2	ERLH_10C340	IES	ERLH_10C330	IES
	D3					B1-U0-G3	B1-U0-G2	ERLH_10D340	IES	ERLH_10D330	IES
	E3					B3-U0-G3	B3-U0-G3	ERLH_10E340	IES	ERLH_10E330	IES
11	A3	11500	11000	98	98	B3-U0-G3	B2-U0-G2	ERLH_11A340	IES	ERLH_11A330	IES
	B3					B3-U0-G3	B2-U0-G2	ERLH_11B340	IES	ERLH_11B330	IES
	C3					B2-U0-G3	B2-U0-G3	ERLH_11C340	IES	ERLH_11C330	IES
	D3					B1-U0-G3	B1-U0-G2	ERLH_11D340	IES	ERLH_11D330	IES
	E3					B3-U0-G3	B3-U0-G3	ERLH_11E340	IES	ERLH_11E330	IES
13	A3	13000	12500	111	111	B3-U0-G3	B3-U0-G3	ERLH_13A340	IES	ERLH_13A330	IES
	B3					B2-U0-G3	B2-U0-G3	ERLH_13B340	IES	ERLH_13B330	IES
	C3					B2-U0-G3	B2-U0-G3	ERLH_13C340	IES	ERLH_13C330	IES
	D3					B2-U0-G3	B2-U0-G3	ERLH_13D340	IES	ERLH_13D330	IES
	E3					B3-U0-G3	B3-U0-G3	ERLH_13E340	IES	ERLH_13E330	IES
14	A3	14000	13400	122	122	B3-U0-G3	B3-U0-G3	ERLH_14A340	IES	ERLH_14A330	IES
	B3					B2-U0-G3	B2-U0-G3	ERLH_14B340	IES	ERLH_14B330	IES
	C3					B2-U0-G3	B2-U0-G3	ERLH_14C340	IES	ERLH_14C330	IES
	D3					B2-U0-G3	B2-U0-G3	ERLH_14D340	IES	ERLH_14D330	IES
	E3					B3-U0-G3	B3-U0-G3	ERLH_14E340	IES	ERLH_14E330	IES
15	A3	15000	14400	136	136	B3-U0-G3	B3-U0-G3	ERLH_15A340	IES	ERLH_15A330	IES
	B3					B2-U0-G3	B2-U0-G3	ERLH_15B340	IES	ERLH_15B330	IES
	C3					B2-U0-G3	B2-U0-G3	ERLH_15C340	IES	ERLH_15C330	IES
	D3					B2-U0-G3	B2-U0-G3	ERLH_15D340	IES	ERLH_15D330	IES
	E3					B3-U0-G3	B3-U0-G3	ERLH_15E340	IES	ERLH_15E330	IES
16	A3	16000	15300	149	149	B3-U0-G3	B3-U0-G3	ERLH_16A340	IES	ERLH_16A330	IES
	B3					B3-U0-G3	B3-U0-G3	ERLH_16B340	IES	ERLH_16B330	IES
	C3					B2-U0-G3	B2-U0-G3	ERLH_16C340	IES	ERLH_16C330	IES
	D3					B2-U0-G3	B2-U0-G3	ERLH_16D340	IES	ERLH_16D330	IES
	E3					B3-U0-G3	B3-U0-G3	ERLH_16E340	IES	ERLH_16E330	IES

# Photometrics: Evolve™ LED Streetlight (ERLH)

## ERLH

Type II Narrow  
(13A340)

13,000 Lumens  
4000K  
ERLH\_13A340\_\_IES

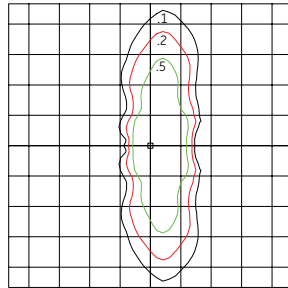

Grid Distance in Units of Mounting Height at 30'  
Initial Footcandle Values at Grade

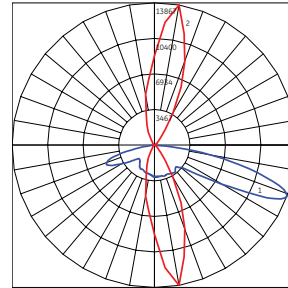

— Vertical plane through horizontal angle of Max. Cd at 80°  
— Horizontal cone through vertical angle of Max. Cd at 69°

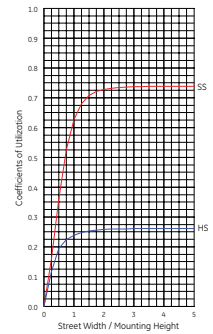

## ERLH

Type II Wide  
(13B340)

13,000 Lumens  
4000K  
ERLH\_13B340\_\_IES

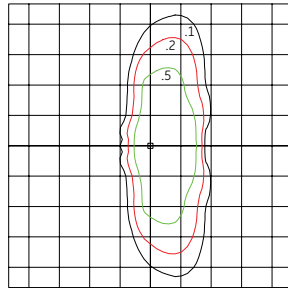

Grid Distance in Units of Mounting Height at 30'  
Initial Footcandle Values at Grade

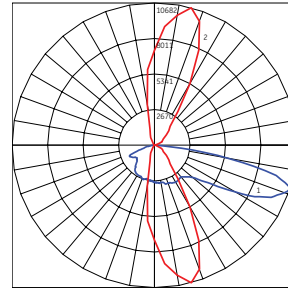

— Vertical plane through horizontal angle of Max. Cd at 75°  
— Horizontal cone through vertical angle of Max. Cd at 72°

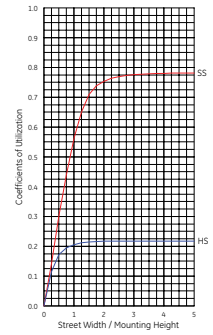

## ERLH

Type III  
(13C340)

13,000 Lumens  
4000K  
ERLH\_13C340\_\_IES

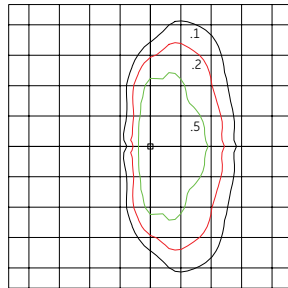

Grid Distance in Units of Mounting Height at 30'  
Initial Footcandle Values at Grade

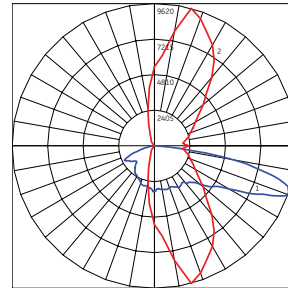

— Vertical plane through horizontal angle of Max. Cd at 75°  
— Horizontal cone through vertical angle of Max. Cd at 71°

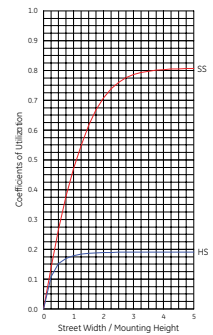

## ERLH

Type IV  
13D340

13,000 Lumens  
4000K  
ERLH\_13D340\_\_IES

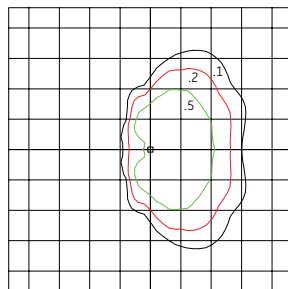

Grid Distance in Units of Mounting Height at 30'  
Initial Footcandle Values at Grade

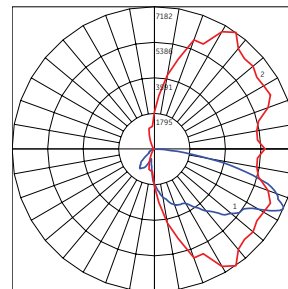

— Vertical plane through horizontal angle of Max. Cd at 55°  
— Horizontal cone through vertical angle of Max. Cd at 65°

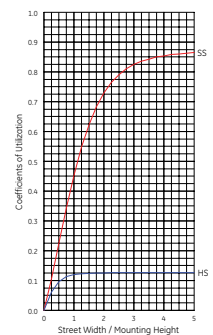

## ERLH

Type II Enhanced Back Light  
13E340

13,000 Lumens  
4000K  
ERLH\_13E340\_\_IES

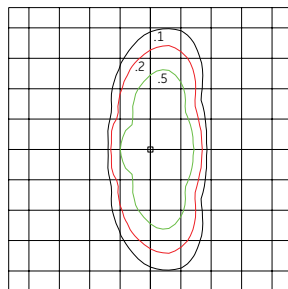

Grid Distance in Units of Mounting Height at 30'  
Initial Footcandle Values at Grade

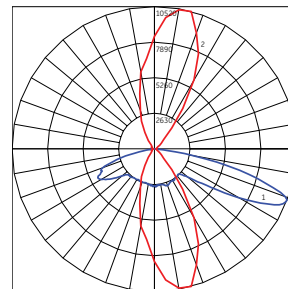

— Vertical plane through horizontal angle of Max. Cd at 75°  
— Horizontal cone through vertical angle of Max. Cd at 69°

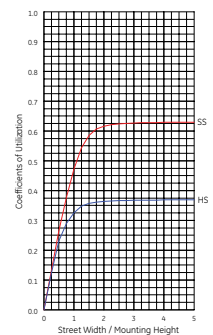



Project name \_\_\_\_\_  
Date \_\_\_\_\_  
Type \_\_\_\_\_

**ERL2**

PROD. ID	VOLTAGE	LUMEN OUTPUT	DISTRIBUTION*	CCT	CONTROLS	COLOR	OPTIONS
<b>E</b> = Evolve <b>R</b> = Roadway <b>L</b> = Local <b>2</b> = Double Module	<b>0</b> = 120-277V* <b>1</b> = 120 <b>2</b> = 208 <b>3</b> = 240 <b>4</b> = 277 <b>5</b> = 480 <b>D</b> = 347 <b>H</b> = 347-480*#  * Not available with Fusing. Must choose a discrete voltage with F option. # Not available with E controls option.	<b>16</b> <b>18</b> <b>19</b> <b>21</b> <b>23</b> <b>25</b> <b>27</b> <b>28</b> <b>30</b>  See Table	<b>A3</b> = Type II Narrow <b>B3</b> = Type II Wide <b>C3</b> = Type III <b>D3</b> = Type IV <b>E3</b> = Type II Enhanced Back Light  See Table  *Nominal IES Type classing subject to typical variation, individual units may differ.	<b>30</b> = 3000K <> <b>40</b> = 4000K <b>50</b> = 5000K*  <> Select 3000K CCT for IDA approved units.  *50 = 5200K for ERL2 lumen outputs 25, 27, 28, and 30.	<b>A</b> = ANSI C136.41 7-pin <b>D</b> = ANSI C136.41 7-pin with Shorting Cap <b>E</b> = ANSI C136.41 7-pin with non-Dimming PE Control.*  *PE Control Only available for 120-277V or 480V Discrete. Not available for 347-480V or 347V Discrete.  <b>NOTE:</b> Dimming controls wired for 0-10V standard unless DALI option "U" requested.	<b>GRAY</b> = Gray <b>BLCK</b> = Black <b>DKBZ</b> = Dark Bronze	<b>A</b> = 4 Bolt Slipfitter † <b>F</b> = Fusing <b>G</b> = Internal Bubble Level <b>I</b> = IP66 Optical <b>L</b> = Tool-Less Entry <b>R</b> = Secondary 10kV/5kA SPD <b>T</b> = Secondary 20kV/10kA SPD <b>U</b> = DALI Programmable ^ <b>V1</b> = Variable Output via Field Adjustable Module** <b>Y</b> = Coastal Finish* <b>XXX</b> = Special Options  † Contact manufacturer for Lead-Time. * Recommended for installations within 750 ft. from the coast. Contact Factory for Lead-Time. + Compatible with LightGrid 2.0 nodes. ^ Not available in 347V, 480V or 347-480V. ** Not available with DALI (U) option.

LUMEN OUTPUT	DISTRIBUTION	TYPICAL INITIAL LUMENS		TYPICAL SYSTEM WATTAGE		BUG RATING		IES FILE NUMBER							
		4000K/5000-5200K	3000K	120-277V	347-480V	4000K	3000K	120-277V		3000K		347-480V			
								120-277V	4000K	347-480V	120-277V	3000K	347-480V		
16	A3	16000	15300	120	120	B3-U0-G3	B3-U0-G3	ERL2_16A340	.IES			ERL2_16A330	.IES		
	B3					B3-U0-G3	B3-U0-G3	ERL2_16B340	.IES			ERL2_16B330	.IES		
	C3					B2-U0-G3	B2-U0-G3	ERL2_16C340	.IES			ERL2_16C330	.IES		
	D3					B2-U0-G3	B2-U0-G3	ERL2_16D340	.IES			ERL2_16D330	.IES		
	E3					B3-U0-G3	B3-U0-G3	ERL2_16E340	.IES			ERL2_16E330	.IES		
18	A3	18000	17300	140	140	B3-U0-G3	B3-U0-G3	ERL2_18A340	.IES			ERL2_18A330	.IES		
	B3					B3-U0-G3	B3-U0-G3	ERL2_18B340	.IES			ERL2_18B330	.IES		
	C3					B2-U0-G3	B2-U0-G3	ERL2_18C340	.IES			ERL2_18C330	.IES		
	D3					B2-U0-G3	B2-U0-G3	ERL2_18D340	.IES			ERL2_18D330	.IES		
	E3					B3-U0-G3	B3-U0-G3	ERL2_18E340	.IES			ERL2_18E330	.IES		
19	A3	19000	18200	149	149	B3-U0-G3	B3-U0-G3	ERL2_19A340	.IES			ERL2_19A330	.IES		
	B3					B3-U0-G3	B3-U0-G3	ERL2_19B340	.IES			ERL2_19B330	.IES		
	C3					B3-U0-G3	B2-U0-G3	ERL2_19C340	.IES			ERL2_19C330	.IES		
	D3					B2-U0-G3	B2-U0-G3	ERL2_19D340	.IES			ERL2_19D330	.IES		
	E3					B3-U0-G3	B3-U0-G3	ERL2_19E340	.IES			ERL2_19E330	.IES		
21	A3	21000	20100	174	177	B3-U0-G3	B3-U0-G3	ERL2_21A340	-120-277V/IES	ERL2_21A340	-347-480V/IES	ERL2_21A330	-120-277V/IES	ERL2_21A330	-347-480V/IES
	B3					B3-U0-G3	B3-U0-G3	ERL2_21B340	-120-277V/IES	ERL2_21B340	-347-480V/IES	ERL2_21B330	-120-277V/IES	ERL2_21B330	-347-480V/IES
	C3					B3-U0-G3	B3-U0-G3	ERL2_21C340	-120-277V/IES	ERL2_21C340	-347-480V/IES	ERL2_21C330	-120-277V/IES	ERL2_21C330	-347-480V/IES
	D3					B2-U0-G3	B2-U0-G3	ERL2_21D340	-120-277V/IES	ERL2_21D340	-347-480V/IES	ERL2_21D330	-120-277V/IES	ERL2_21D330	-347-480V/IES
	E3					B3-U0-G3	B3-U0-G3	ERL2_21E340	-120-277V/IES	ERL2_21E340	-347-480V/IES	ERL2_21E330	-120-277V/IES	ERL2_21E330	-347-480V/IES
23	A3	23000	22100	194	196	B3-U0-G3	B3-U0-G3	ERL2_23A340	-120-277V/IES	ERL2_23A340	-347-480V/IES	ERL2_23A330	-120-277V/IES	ERL2_23A330	-347-480V/IES
	B3					B3-U0-G3	B3-U0-G3	ERL2_23B340	-120-277V/IES	ERL2_23B340	-347-480V/IES	ERL2_23B330	-120-277V/IES	ERL2_23B330	-347-480V/IES
	C3					B3-U0-G4	B3-U0-G4	ERL2_23C340	-120-277V/IES	ERL2_23C340	-347-480V/IES	ERL2_23C330	-120-277V/IES	ERL2_23C330	-347-480V/IES
	D3					B2-U0-G4	B2-U0-G4	ERL2_23D340	-120-277V/IES	ERL2_23D340	-347-480V/IES	ERL2_23D330	-120-277V/IES	ERL2_23D330	-347-480V/IES
	E3					B4-U0-G4	B3-U0-G3	ERL2_23E340	-120-277V/IES	ERL2_23E340	-347-480V/IES	ERL2_23E330	-120-277V/IES	ERL2_23E330	-347-480V/IES
25	A3	25000	24000	214	214	B3-U0-G3	B3-U0-G3	ERL2_25A340	.IES			ERL2_25A330	.IES		
	B3					B3-U0-G3	B3-U0-G3	ERL2_25B340	.IES			ERL2_25B330	.IES		
	C3					B3-U0-G4	B3-U0-G4	ERL2_25C340	.IES			ERL2_25C330	.IES		
	D3					B2-U0-G4	B2-U0-G4	ERL2_25D340	.IES			ERL2_25D330	.IES		
	E3					B4-U0-G4	B4-U0-G4	ERL2_25E340	.IES			ERL2_25E330	.IES		
27	A3	27000	25900	237	237	B3-U0-G3	B3-U0-G3	ERL2_27A340	.IES			ERL2_27A330	.IES		
	B3					B3-U0-G4	B3-U0-G4	ERL2_27B340	.IES			ERL2_27B330	.IES		
	C3					B3-U0-G4	B3-U0-G4	ERL2_27C340	.IES			ERL2_27C330	.IES		
	D3					B2-U0-G4	B2-U0-G4	ERL2_27D340	.IES			ERL2_27D330	.IES		
	E3					B4-U0-G4	B4-U0-G4	ERL2_27E340	.IES			ERL2_27E330	.IES		
28	A3	28000	26900	251	251	B3-U0-G3	B3-U0-G3	ERL2_28A340	.IES			ERL2_28A330	.IES		
	B3					B3-U0-G4	B3-U0-G4	ERL2_28B340	.IES			ERL2_28B330	.IES		
	C3					B3-U0-G4	B3-U0-G4	ERL2_28C340	.IES			ERL2_28C330	.IES		
	D3					B2-U0-G4	B2-U0-G4	ERL2_28D340	.IES			ERL2_28D330	.IES		
	E3					B4-U0-G4	B4-U0-G4	ERL2_28E340	.IES			ERL2_28E330	.IES		
30	A3	30000	28800	278	278	B4-U0-G4	B4-U0-G4	ERL2_30A340	.IES			ERL2_30A330	.IES		
	B3					B3-U0-G4	B3-U0-G4	ERL2_30B340	.IES			ERL2_30B330	.IES		
	C3					B3-U0-G4	B3-U0-G4	ERL2_30C340	.IES			ERL2_30C330	.IES		
	D3					B2-U0-G4	B2-U0-G4	ERL2_30D340	.IES			ERL2_30D330	.IES		
	E3					B4-U0-G4	B4-U0-G4	ERL2_30E340	.IES			ERL2_30E330	.IES		



# Photometrics: Evolve™ LED Streetlight (ERL2)

## ERL2

Type II Narrow  
(23A340)

23,000 Lumens  
4000K  
ERL2\_23A340\_\_\_.IES

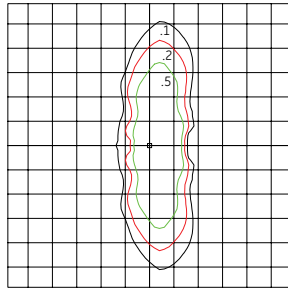

Grid Distance in Units of Mounting Height at 30'  
Initial Footcandle Values at Grade

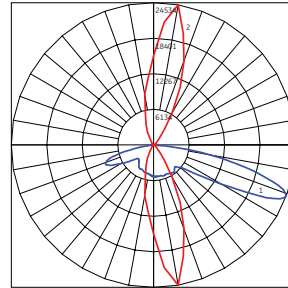

— Vertical plane through horizontal angle of Max. Cd at 80°  
— Horizontal cone through vertical angle of Max. Cd at 69°

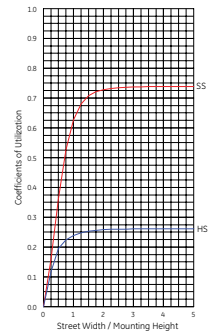

## ERL2

Type II Wide  
(23B340)

23,000 Lumens  
4000K  
ERL2\_23B340\_\_\_.IES

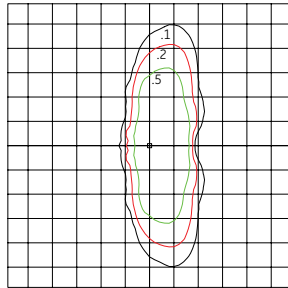

Grid Distance in Units of Mounting Height at 30'  
Initial Footcandle Values at Grade

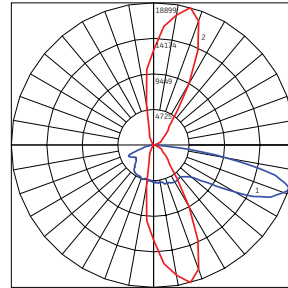

— Vertical plane through horizontal angle of Max. Cd at 75°  
— Horizontal cone through vertical angle of Max. Cd at 72°

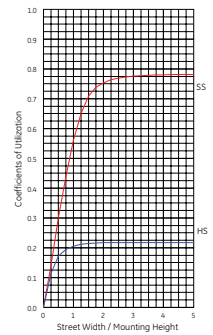

## ERL2

Type III  
(23C340)

23,000 Lumens  
4000K  
ERL2\_23C340\_\_\_.IES

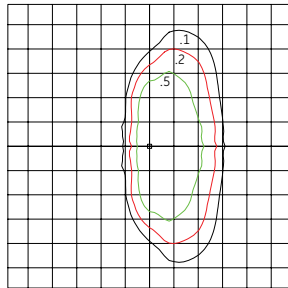

Grid Distance in Units of Mounting Height at 30'  
Initial Footcandle Values at Grade

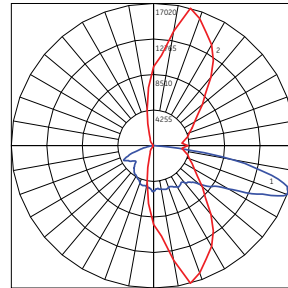

— Vertical plane through horizontal angle of Max. Cd at 75°  
— Horizontal cone through vertical angle of Max. Cd at 71°

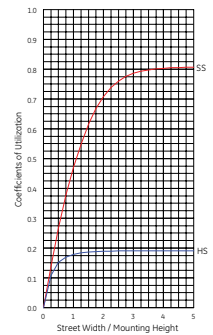

## ERL2

Type IV  
(23D340)

23,000 Lumens  
4000K  
ERL2\_23D340\_\_\_.IES

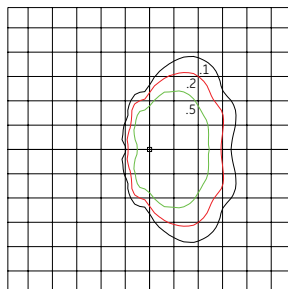

Grid Distance in Units of Mounting Height at 30'  
Initial Footcandle Values at Grade

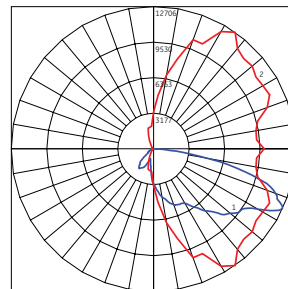

— Vertical plane through horizontal angle of Max. Cd at 55°  
— Horizontal cone through vertical angle of Max. Cd at 65°

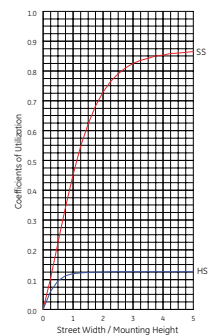

## ERL2

Type II Enhanced Back Light  
(23E340)

23,000 Lumens  
4000K  
ERL2\_23E340\_\_\_.IES

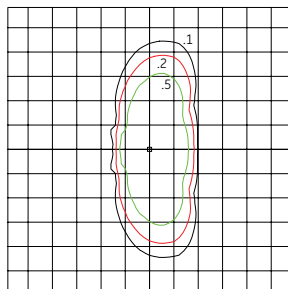

Grid Distance in Units of Mounting Height at 30'  
Initial Footcandle Values at Grade

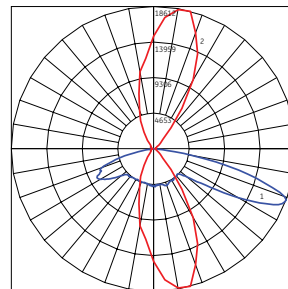

— Vertical plane through horizontal angle of Max. Cd at 75°  
— Horizontal cone through vertical angle of Max. Cd at 69°

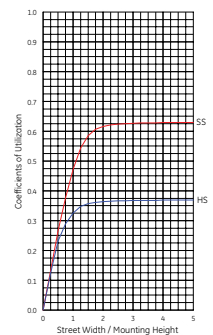

**GE Evolve™**  
 LED Roadway Lighting  
 ERL1-ERLH-ERL2

**Product Dimensions:**  
 Evolve™ LED Streetlight (ERL1)

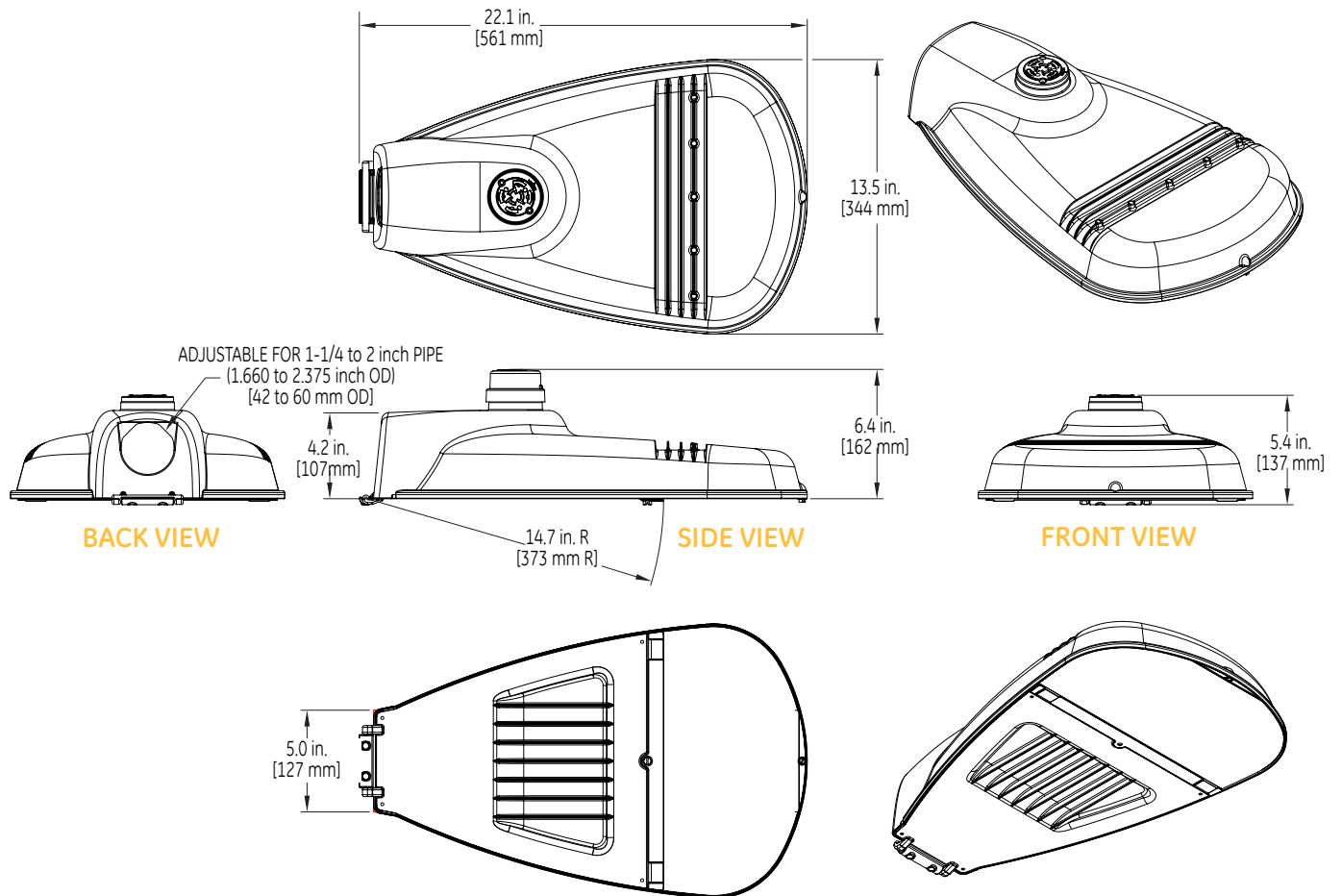

**DATA**

- Approximate net weight: 12.4 lbs (5.6kgs) -15.5 lbs (7.0kgs) with XFMR
- Effective Projected Area (EPA): 0.5 sq ft max (0.046 sq m)

**GE Evolve™**  
 LED Roadway Lighting  
 ERL1-ERLH-ERL2

**Product Dimensions:**  
 Evolve™ LED Streetlight (ERLH)

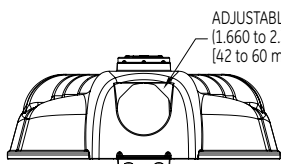
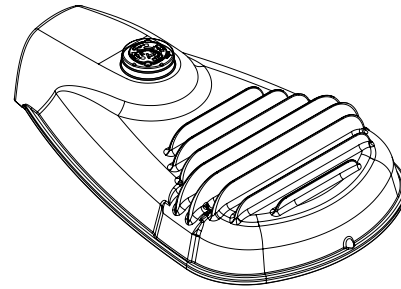
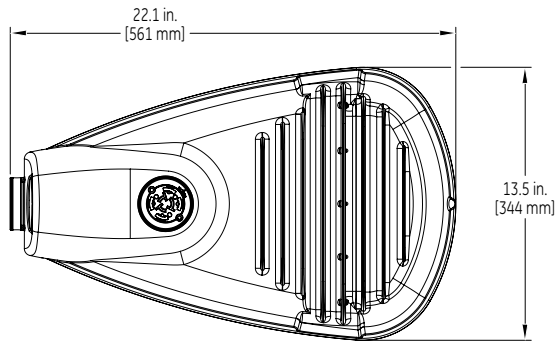

**BACK VIEW**

ADJUSTABLE FOR 1-1/4 to 2 inch PIPE  
 (1.660 to 2.375 inch OD)  
 (42 to 60 mm OD)

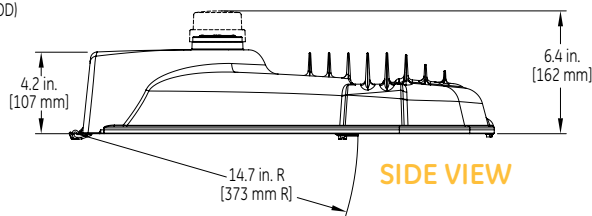

**SIDE VIEW**

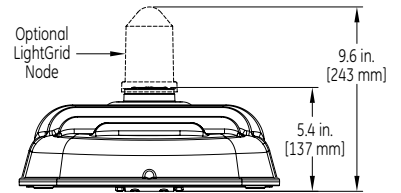

**FRONT VIEW**

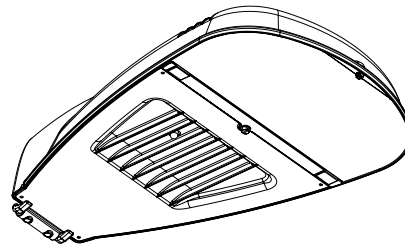
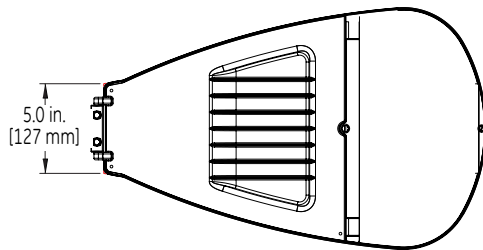

**DATA**

- Approximate net weight: 15.15 lbs (6.9 kgs) - 2 Bolt Slipfitter
- Approximate net weight: 15.85 lbs (7.2 kgs) - 4 Bolt Slipfitter
- Effective Projected Area (EPA): 0.5 sq ft max (0.046 sq m)

**GE Evolve™**  
 LED Roadway Lighting  
 ERL1-ERLH-ERL2

**Product Dimensions:**  
 Evolve™ LED Streetlight (ERL2)

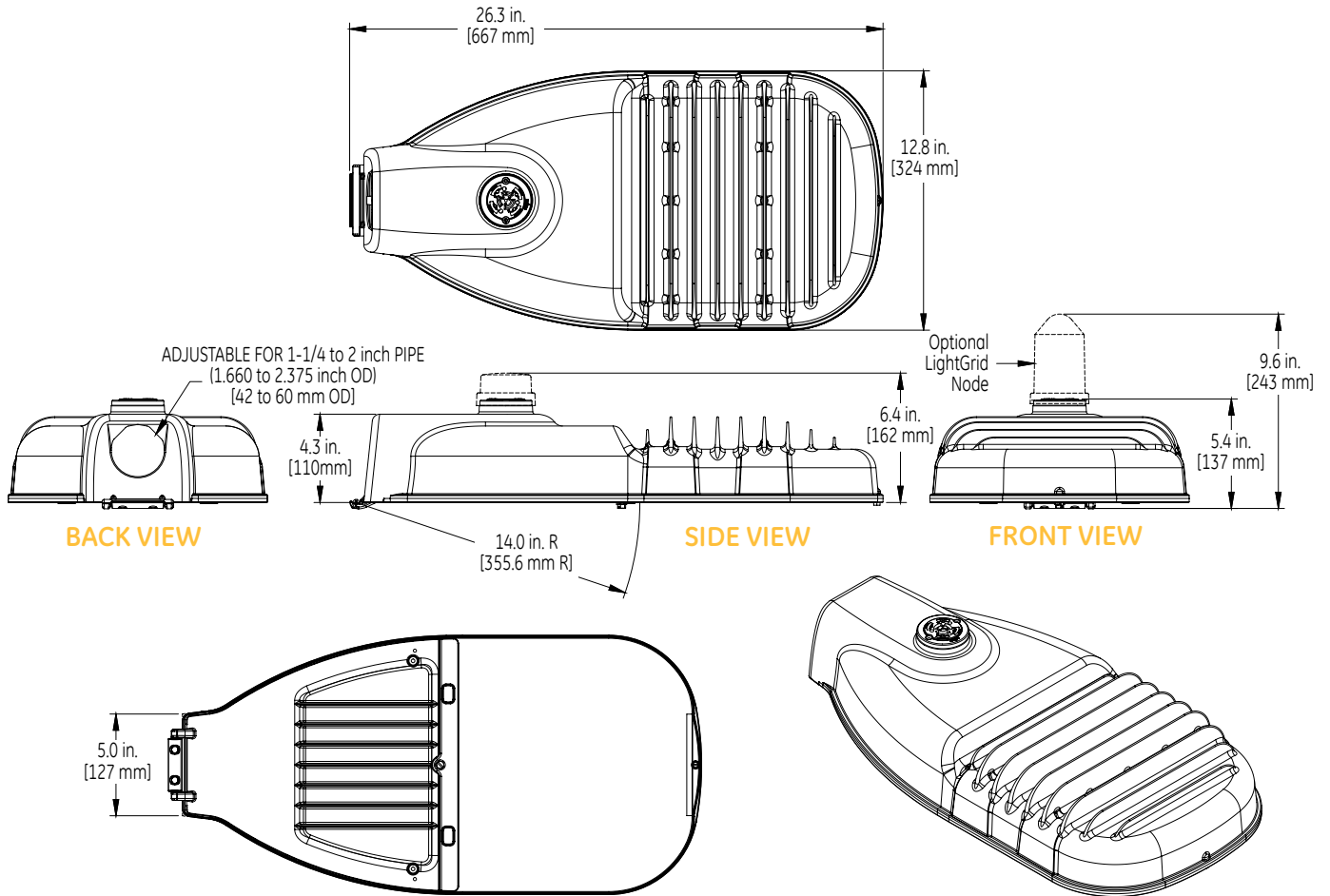

**DATA**

- Approximate net weight: 24.0 lbs (10.9 kgs)  
 Contact manufacturer for specific configuration weight.
- Effective Projected Area (EPA): 0.57 sq ft max (0.053 sq m)