

PLAN AND PROFILE
 SUM-271-0850 - CULVERT REPLACEMENT

DESIGN AGENCY



DESIGNER
 MJP

REVIEWER
 TJP 11-09-23

PROJECT ID
 93101

SHEET	TOTAL
P.1	16

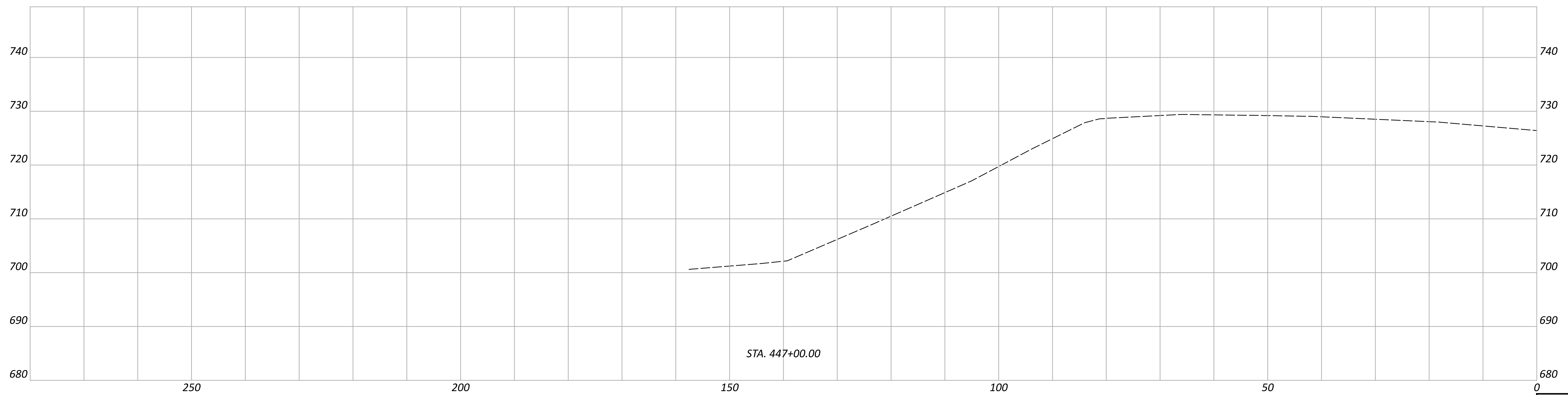
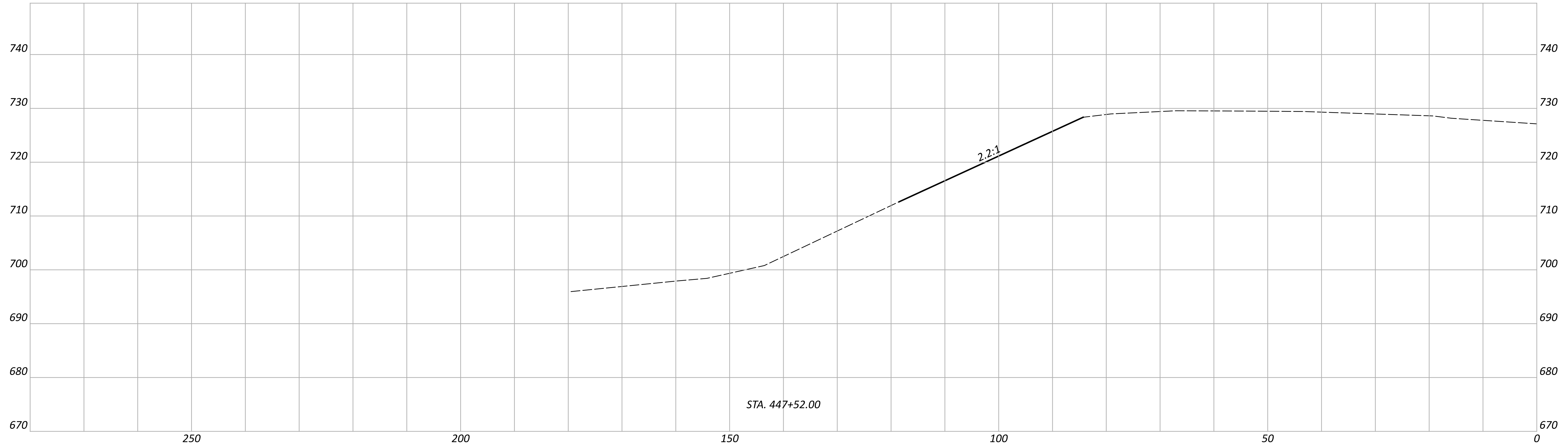

CROSS SECTIONS - SUM-271-0850
 STA. 447+00 - 447+52

DESIGN AGENCY



DESIGNER

MJP

REVIEWER

TJP 11-09-23

PROJECT ID

93101

Sheet Totals			SHEET	TOTAL
Seeding	Cut	Fill	P.2	16
	2	2		

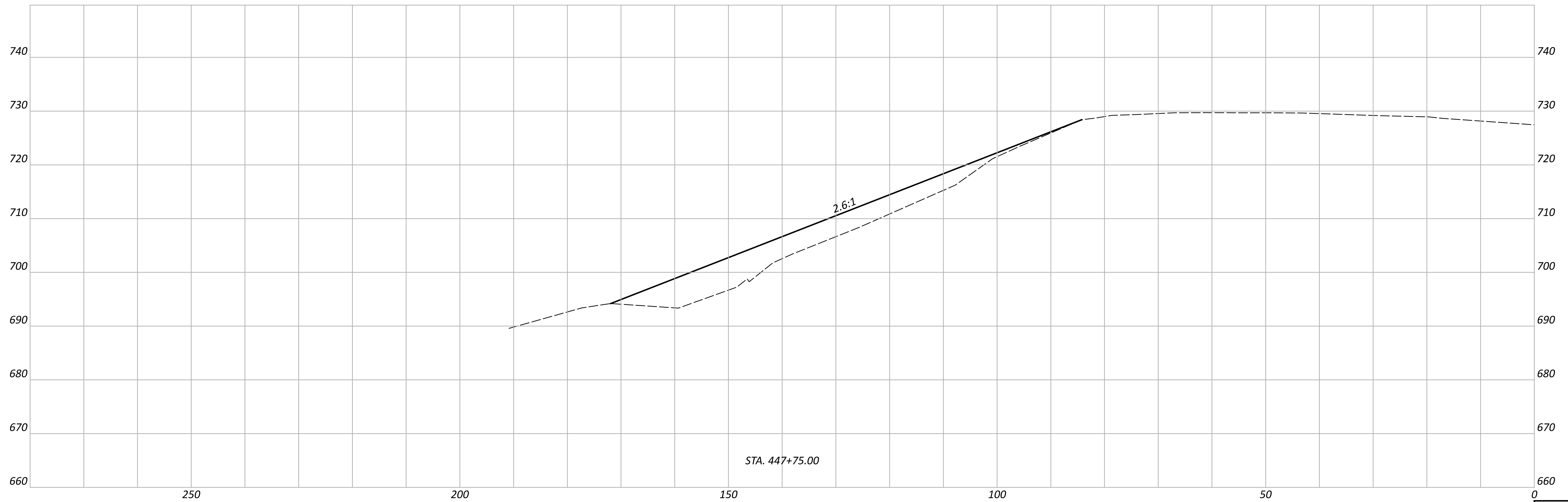
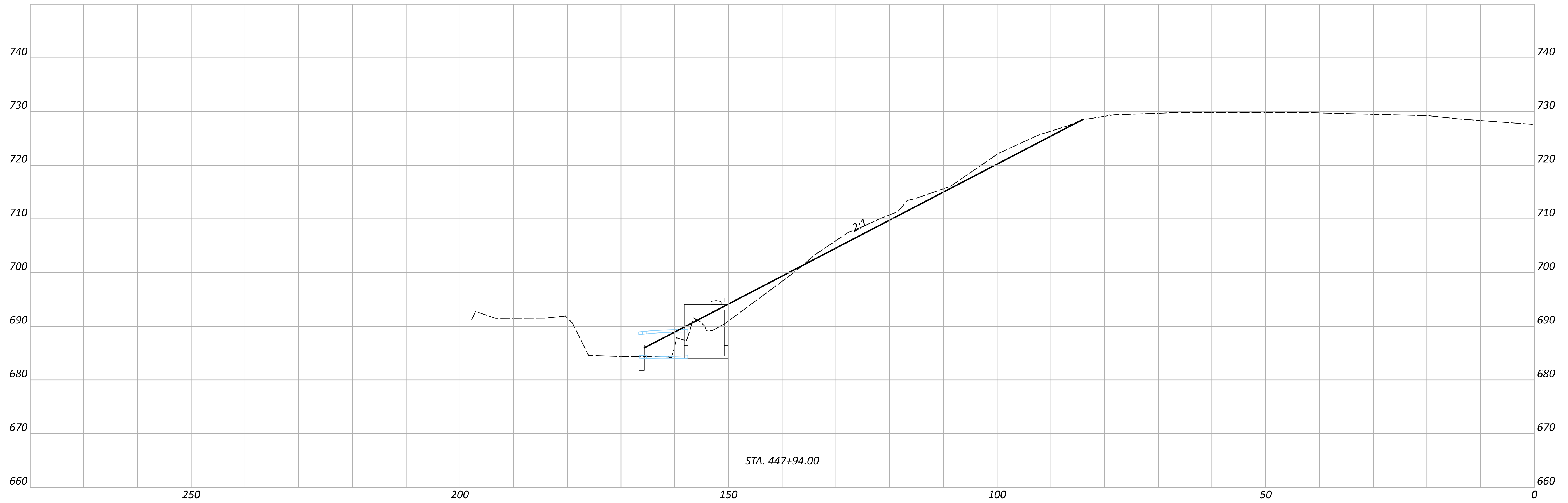

CROSS SECTIONS - SUM-271-0850
STA. 447+75 - 447+94

DESIGN AGENCY



DESIGNER

MJP

REVIEWER

TJP 11-09-23

PROJECT ID

93101

Sheet Totals			SHEET TOTAL	
Seeding	Cut	Fill	P.3	16
	26	295		

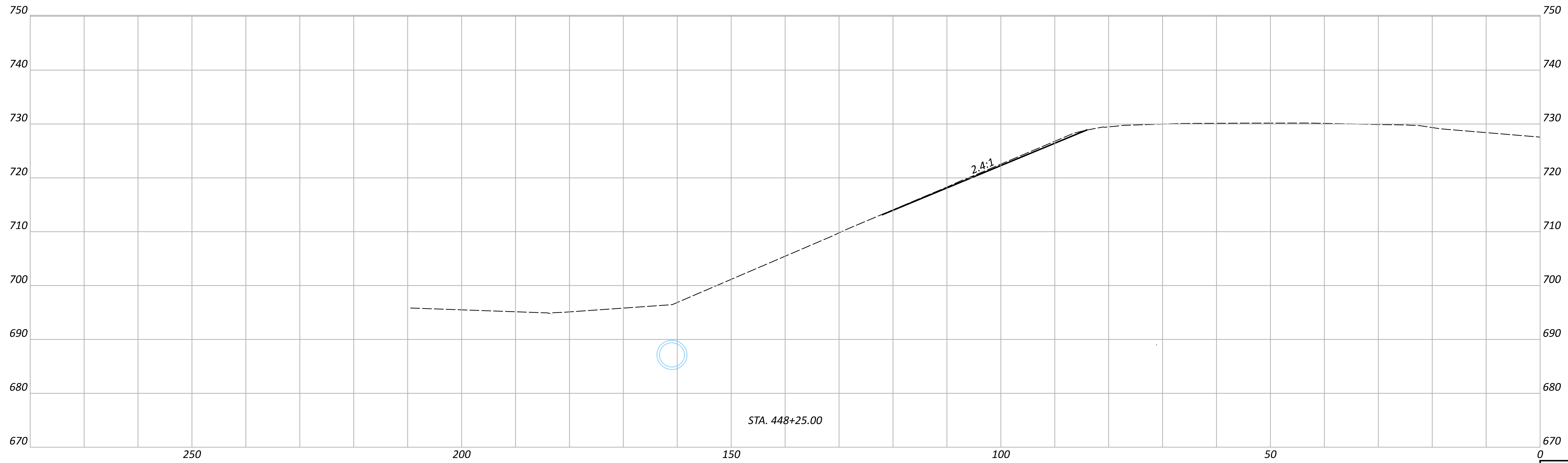
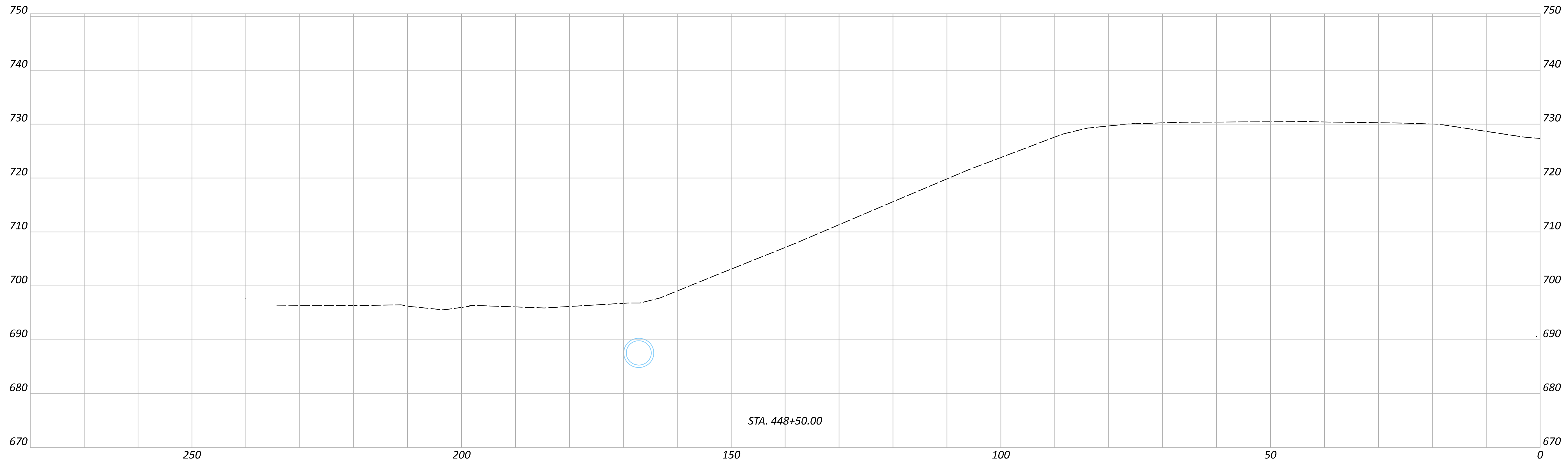

CROSS SECTIONS - SUM-271-0850
 STA. 448+25 - 448+50

DESIGN AGENCY



DESIGNER
 MJP

REVIEWER
 TJP 11-09-23

PROJECT ID
 93101

Sheet Totals			SHEET	TOTAL
Seeding	Cut	Fill		
	35	30	P.4	16

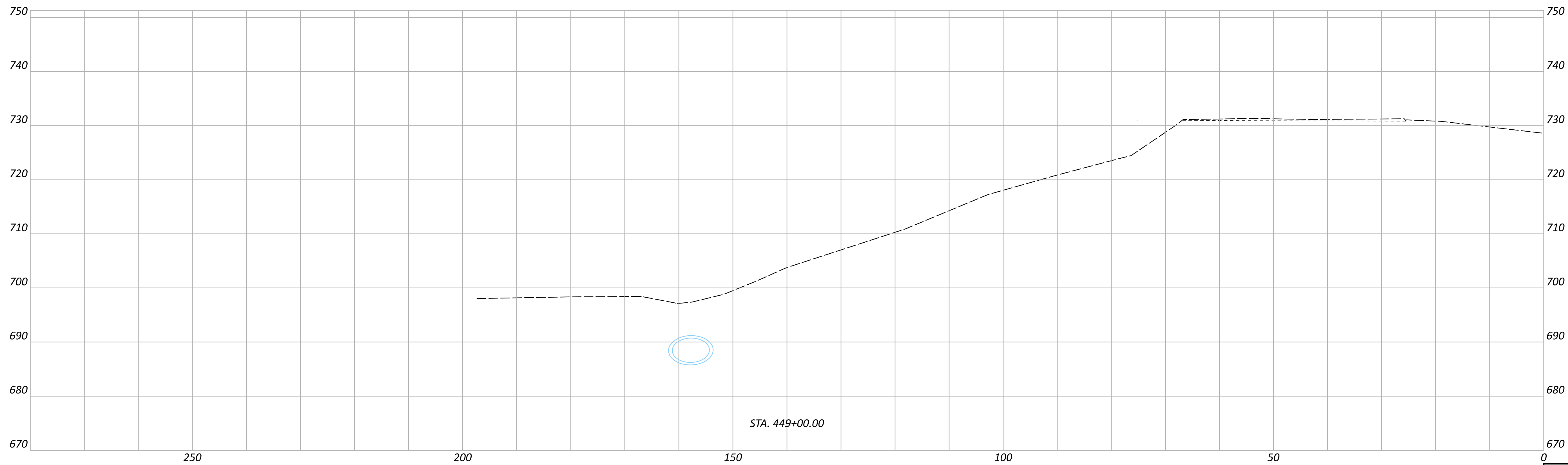
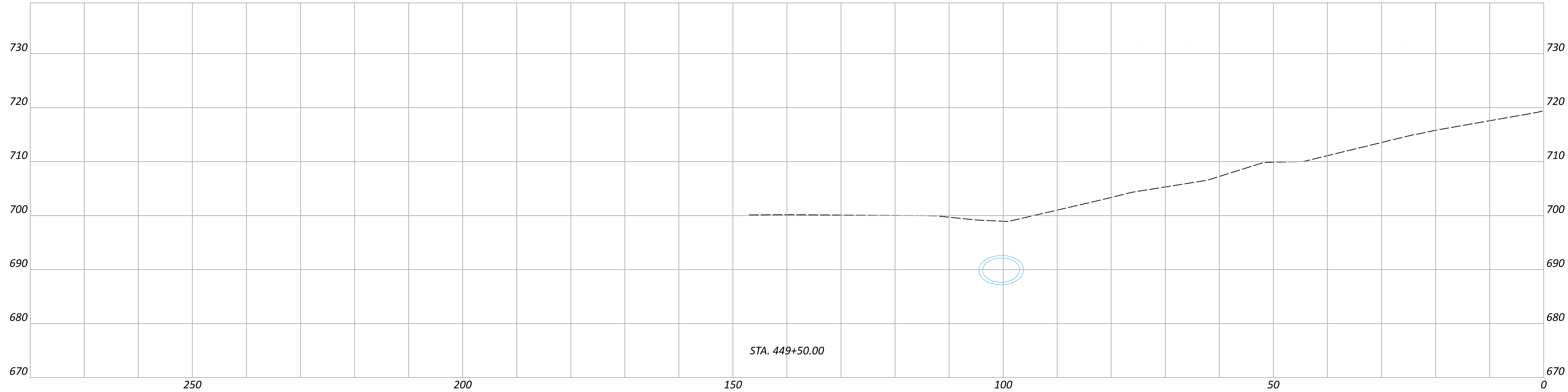

CROSS SECTIONS - SUM-271-0850
 STA. 449+00 - 449+50

DESIGN AGENCY



DESIGNER

MJP

REVIEWER

TJP 11-09-23

PROJECT ID

93101

Sheet Totals

Seeding	Cut	Fill
0	0	0

SHEET	TOTAL
P.5	16

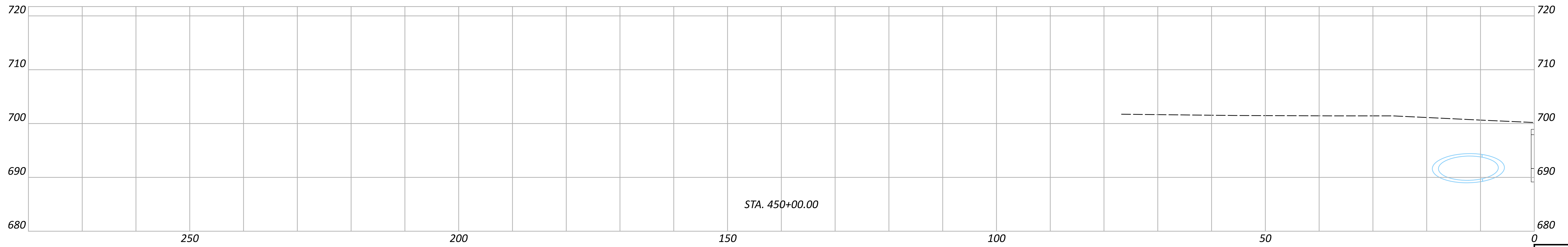

STA. 450+00.00

Sheet Totals			SHEET TOTAL	
Seeding	Cut	Fill	P.6	16

DESIGN AGENCY



DESIGNER

MJP

REVIEWER

TJP 11-09-23

PROJECT ID

93101

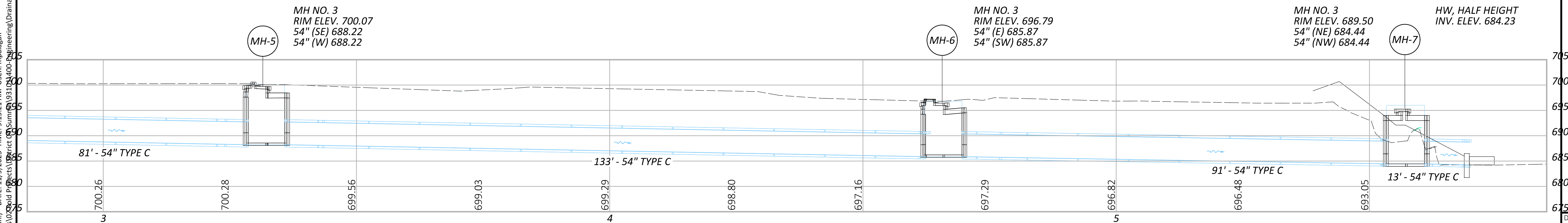
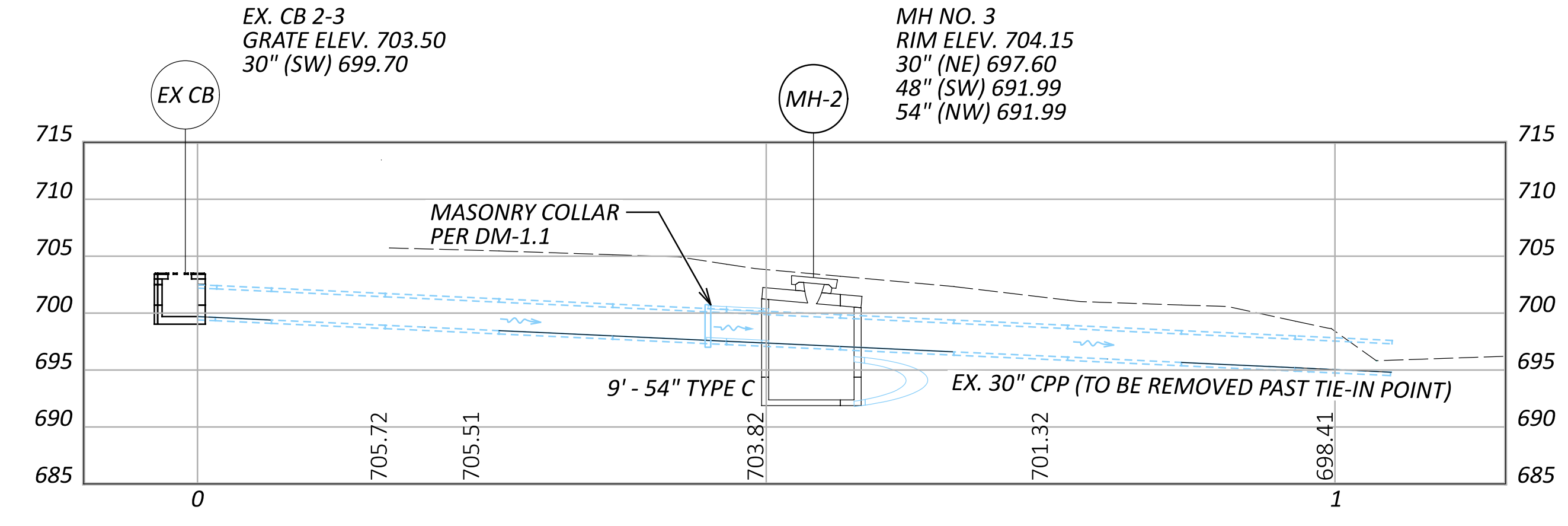
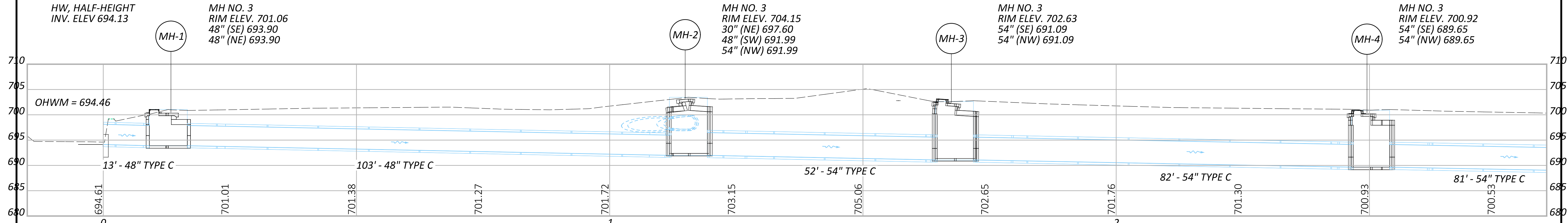

DRAINAGE PROFILE
SUM-271-0850 CULVERT REPLACEMENT

DESIGN AGENCY	
DESIGNER	MJP
REVIEWER	TJP
PROJECT ID	93101
SHEET	P.7
TOTAL	16

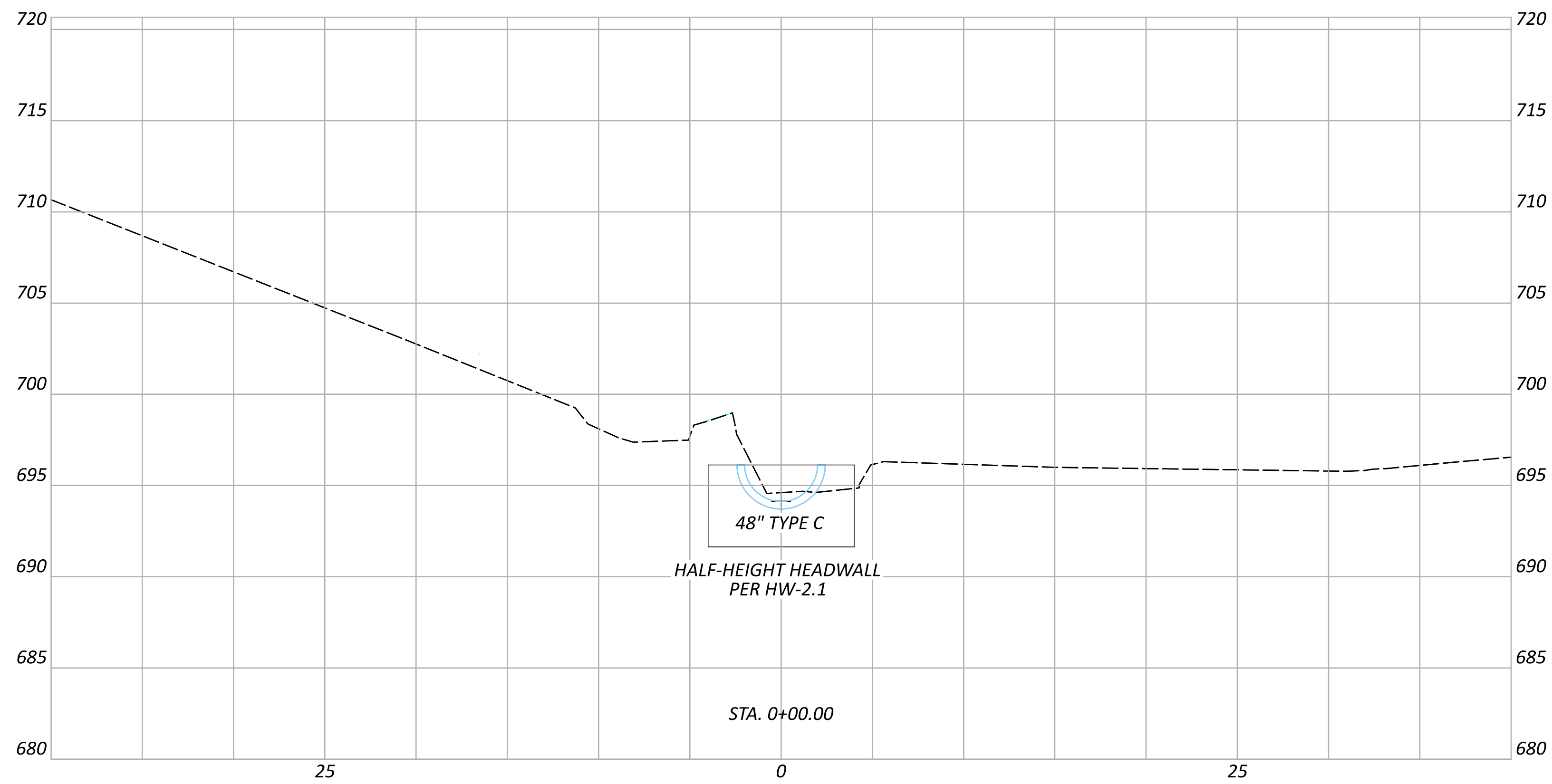
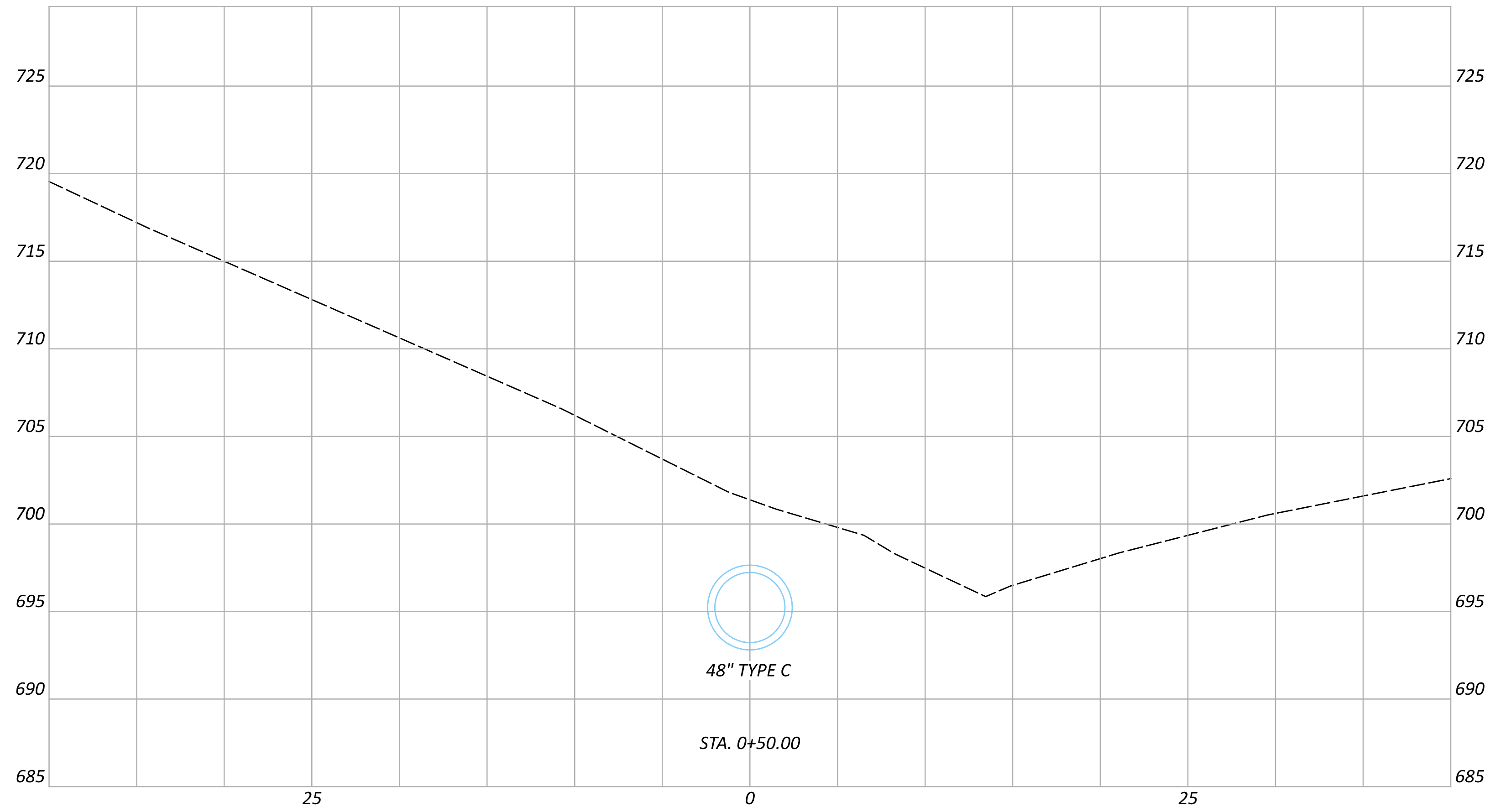

DRAINAGE CROSS SECTIONS
 SUM-271-0850 CULVERT REPLACEMENT

DESIGN AGENCY



DESIGNER
 MJP

REVIEWER
 TJP 11-09-23

PROJECT ID
 93101

Sheet Totals			SHEET	TOTAL
Seeding	Cut	Fill		
			P.8	16

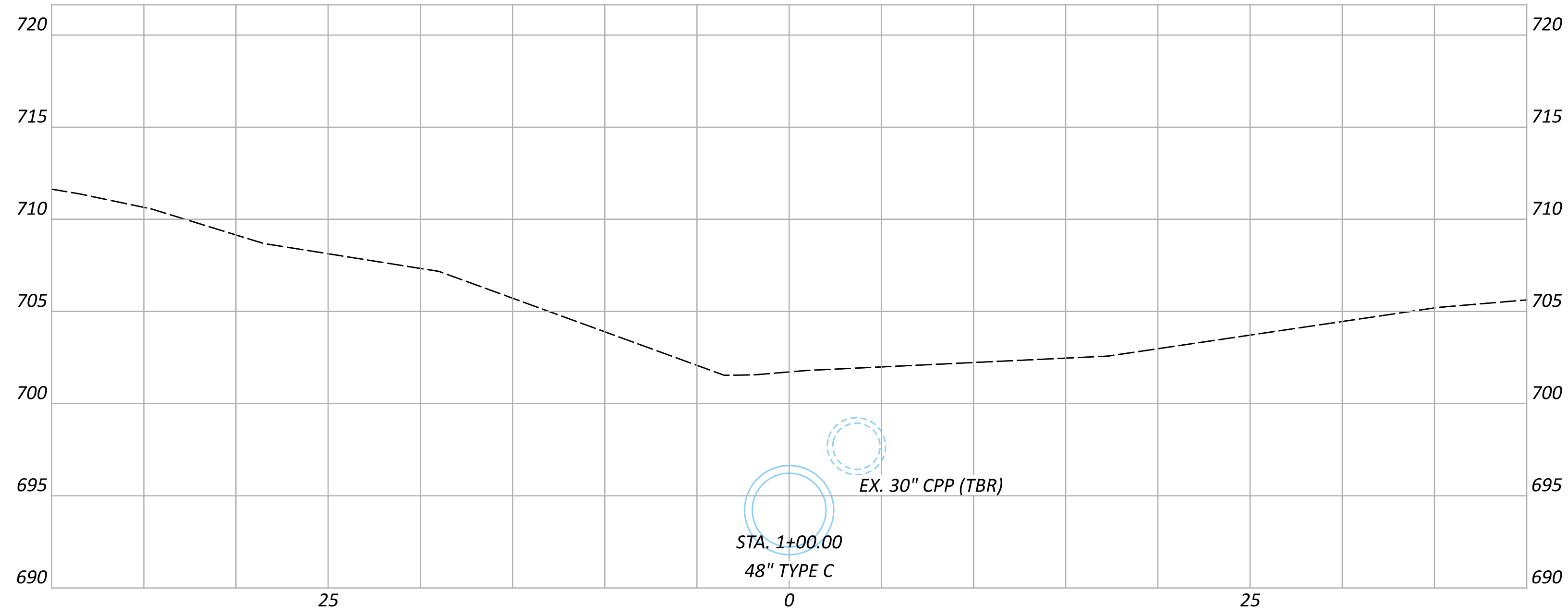
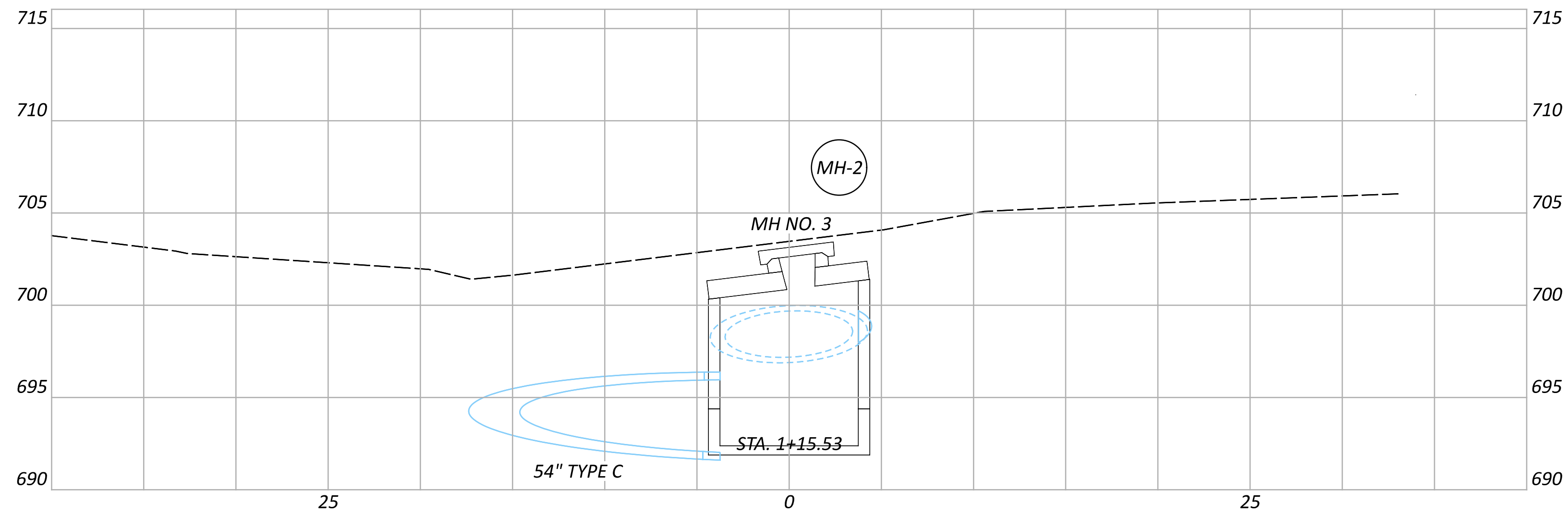

DRAINAGE CROSS SECTIONS
 SUM-271-0850 CULVERT REPLACEMENT

DESIGN AGENCY



DESIGNER

MJP

REVIEWER

TJP 11-09-23

PROJECT ID

93101

Sheet Totals			SHEET	TOTAL
Seeding	Cut	Fill		
			P.9	16

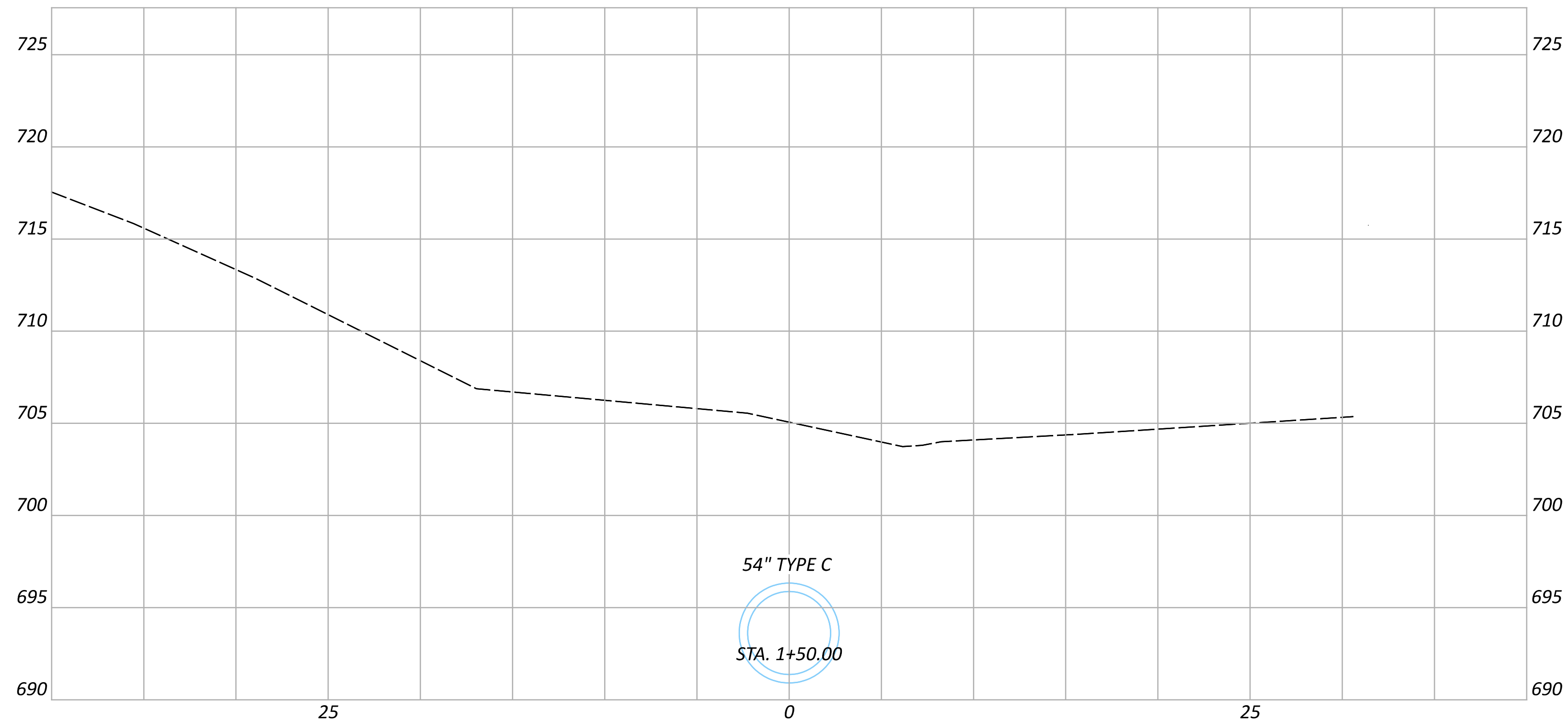
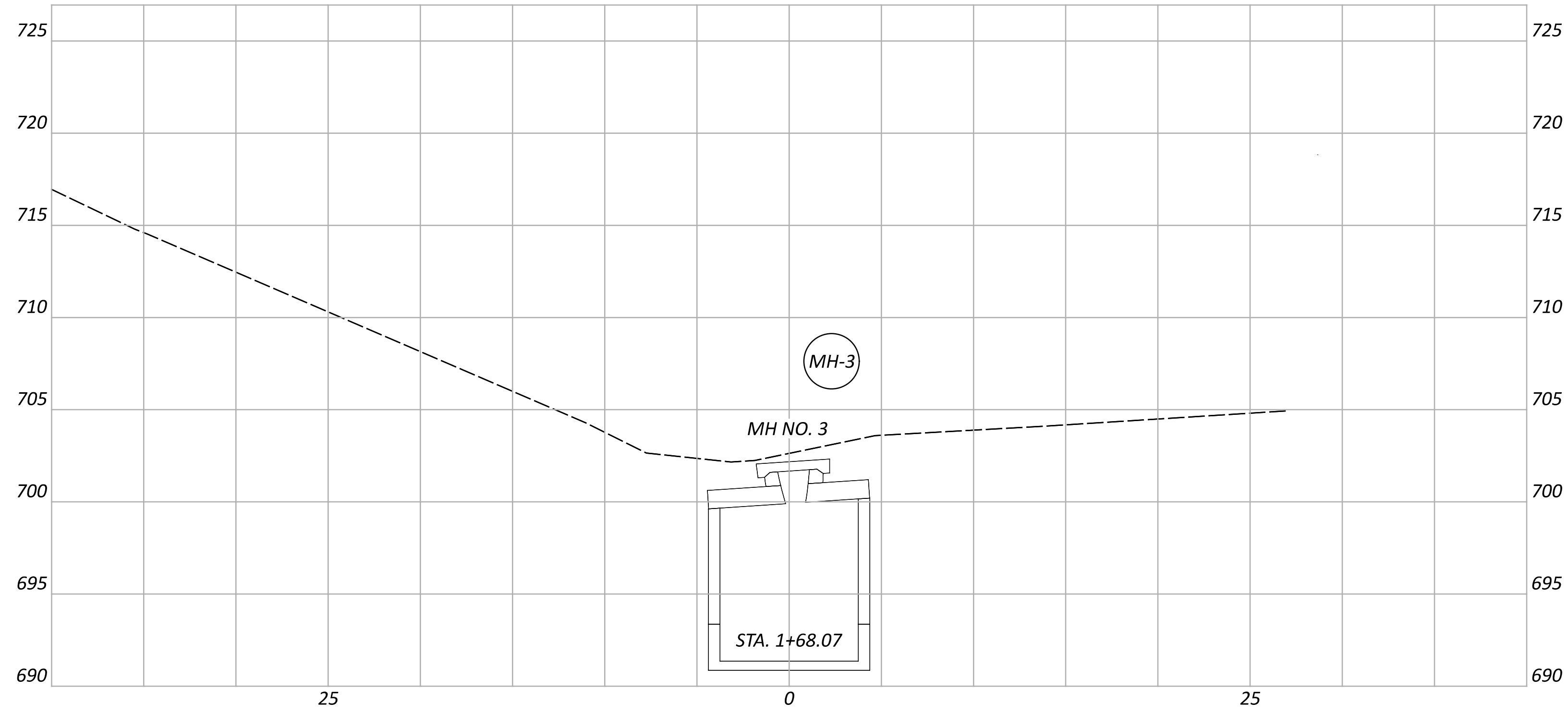

DRAINAGE CROSS SECTIONS
 SUM-271-0850 CULVERT REPLACEMENT

DESIGN AGENCY



DESIGNER

MJP

REVIEWER

TJP 11-09-23

PROJECT ID

93101

Sheet Totals			SHEET	TOTAL
Seeding	Cut	Fill		
			P.10	16

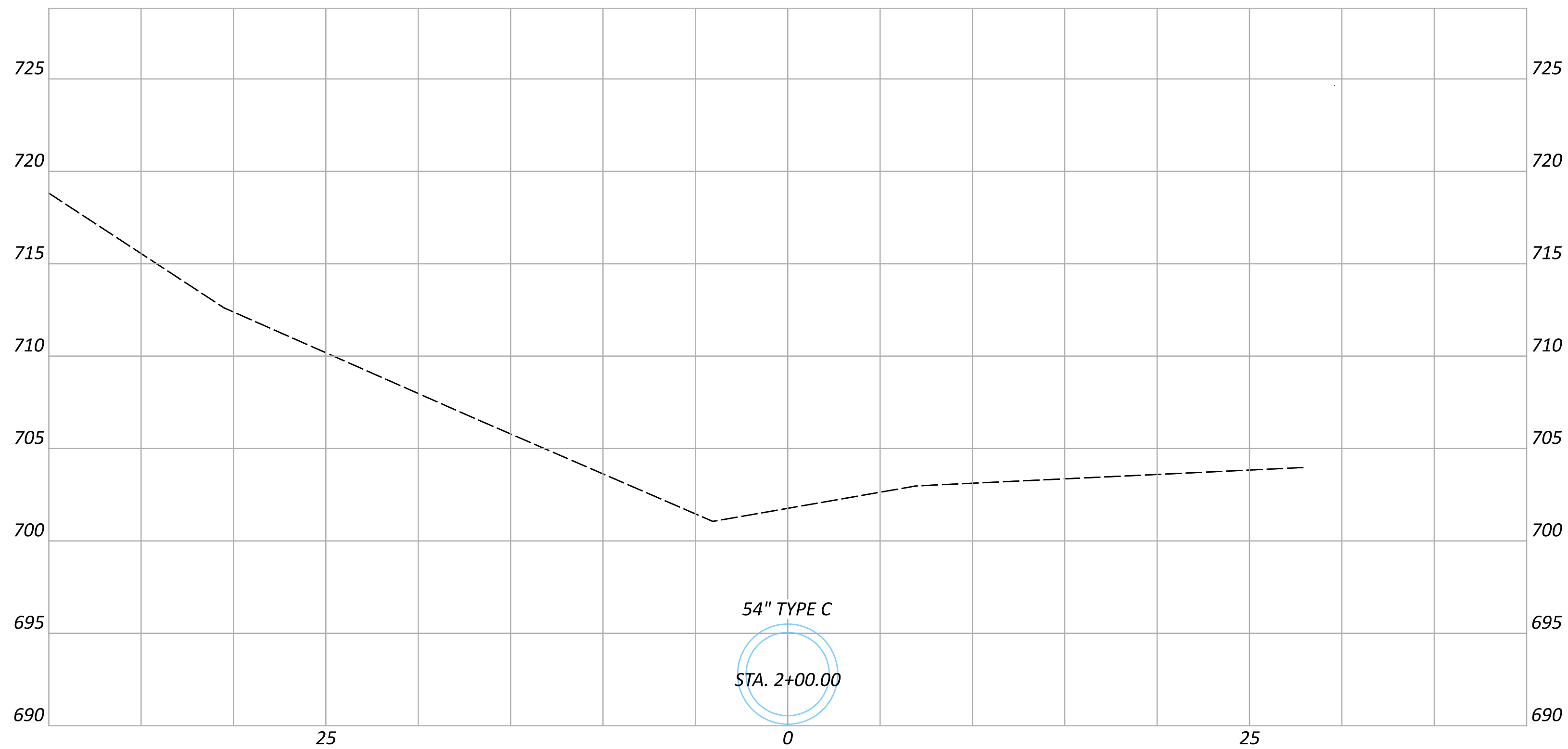
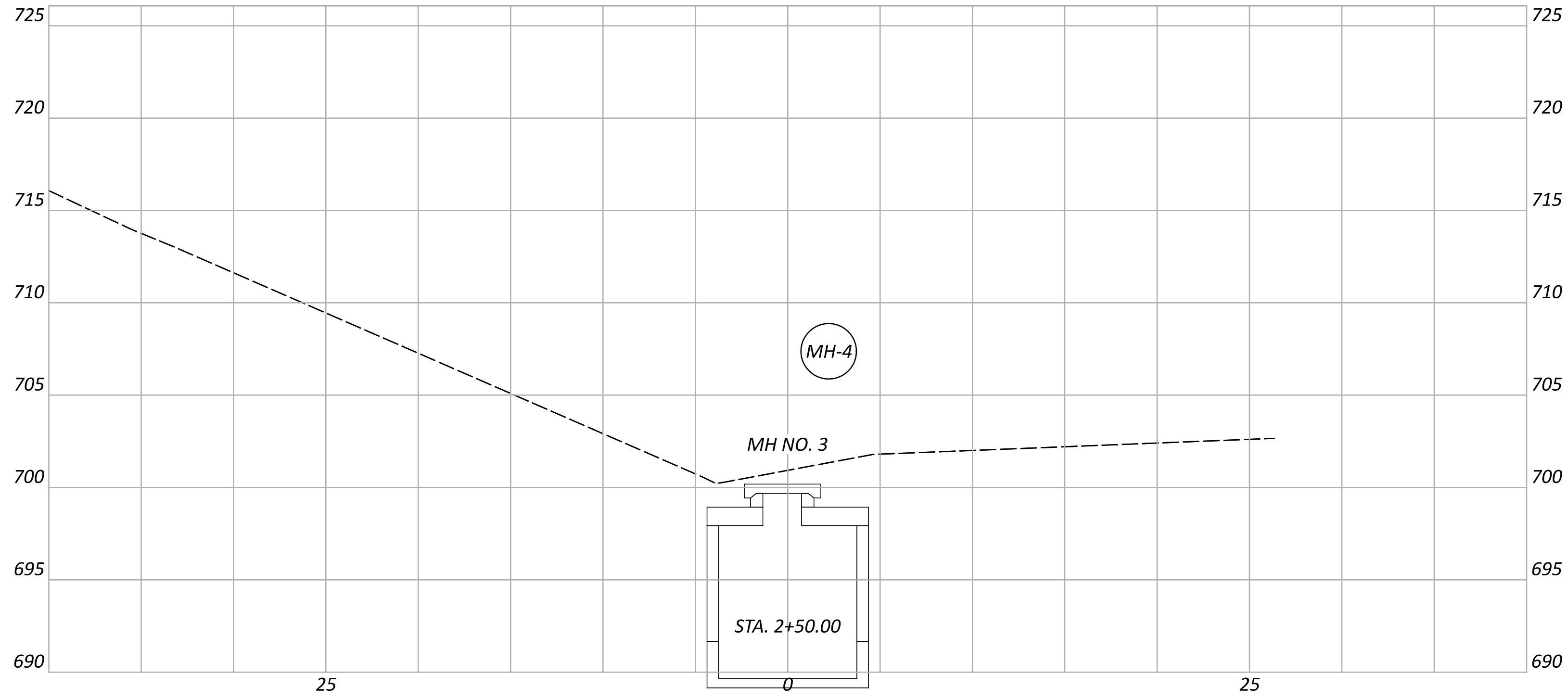

DRAINAGE CROSS SECTIONS
 SUM-271-0850 CULVERT REPLACEMENT

DESIGN AGENCY



DESIGNER

MJP

REVIEWER

TJP 11-09-23

PROJECT ID

93101

Sheet Totals			SHEET	TOTAL
Seeding	Cut	Fill		
			P.11	16

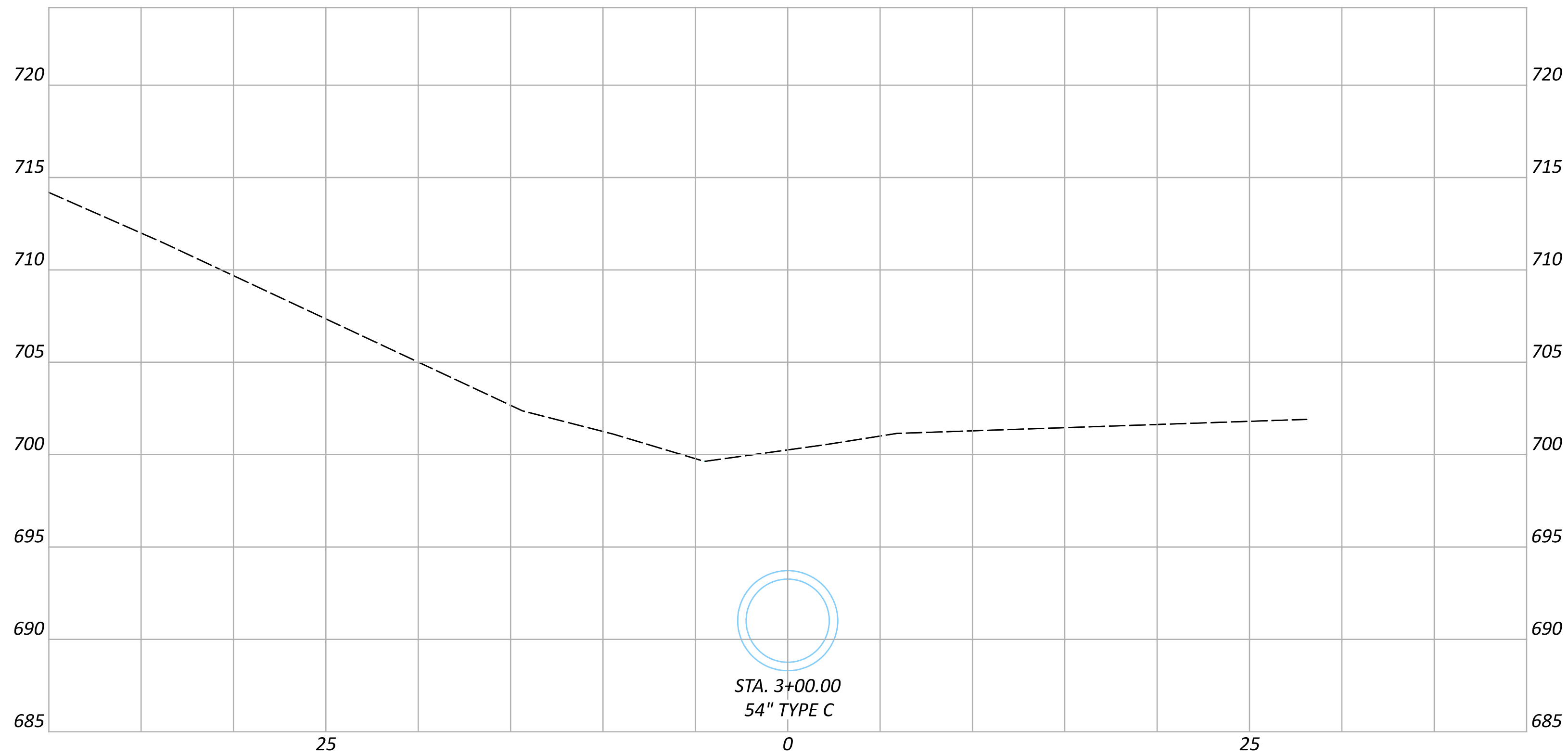
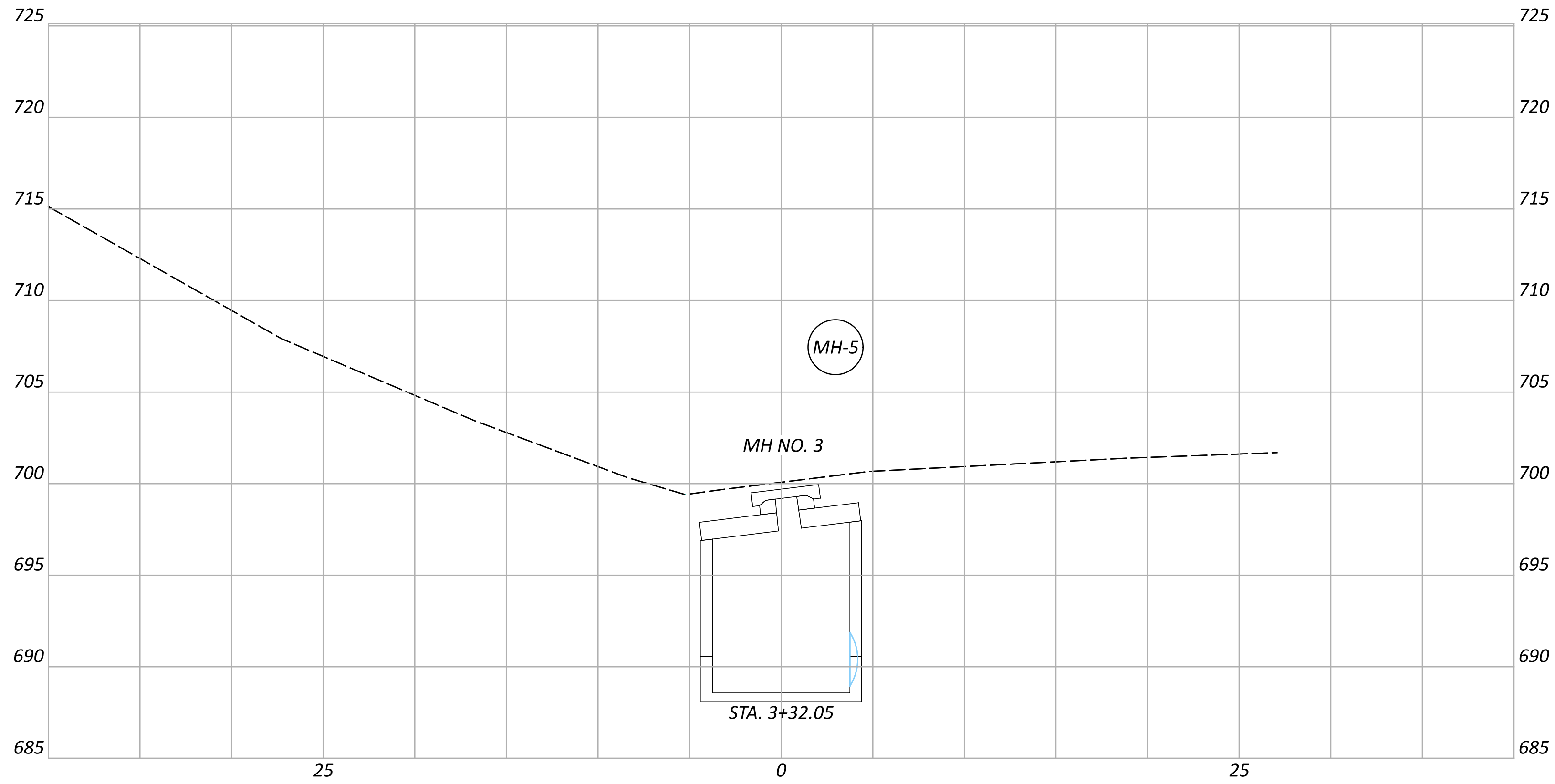

DRAINAGE CROSS SECTIONS
 SUM-271-0850 CULVERT REPLACEMENT

DESIGN AGENCY



DESIGNER

MJP

REVIEWER

TJP 11-09-23

PROJECT ID

93101

Sheet Totals

Seeding	Cut	Fill

SHEET TOTAL

P.12 16

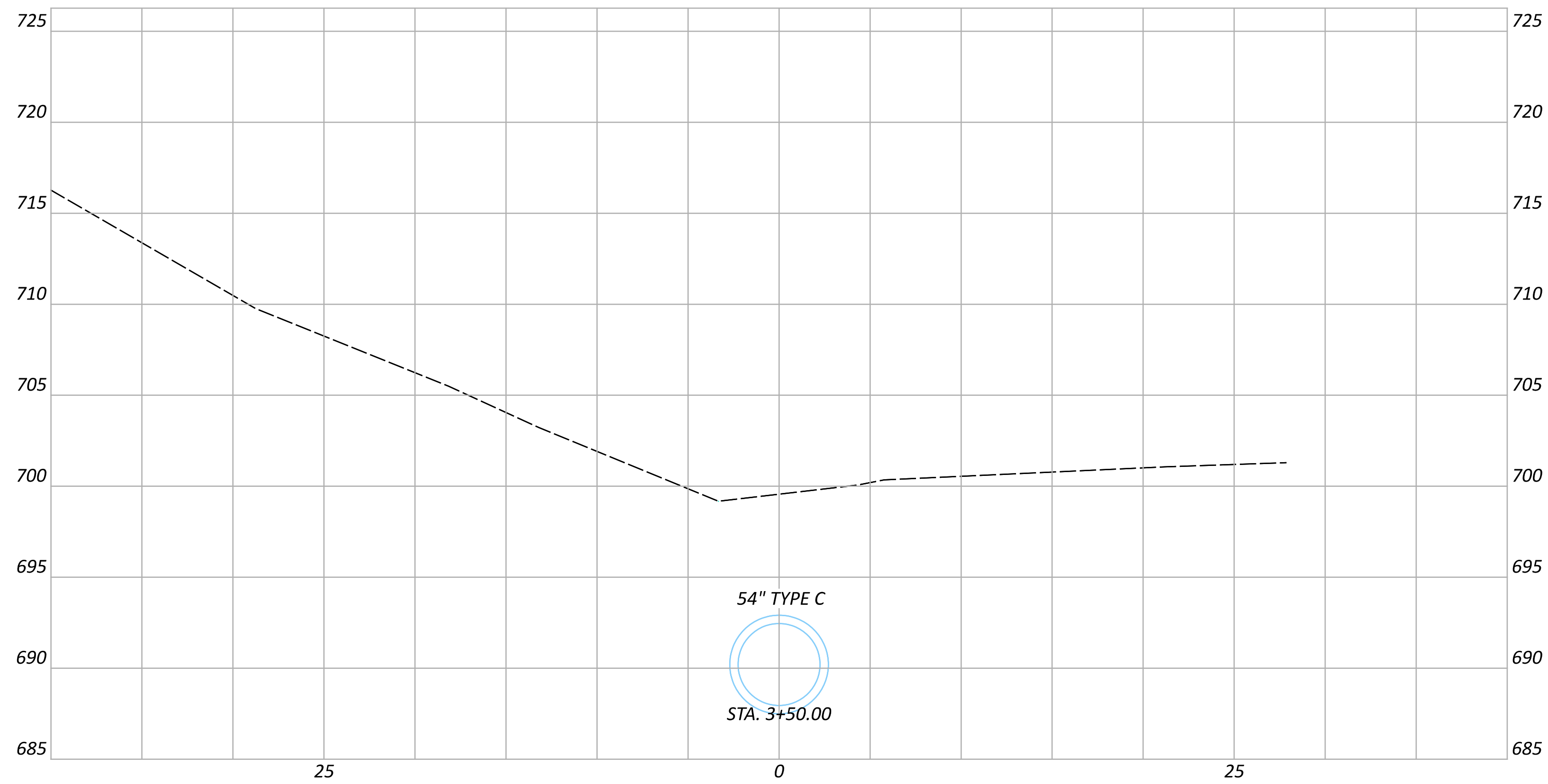
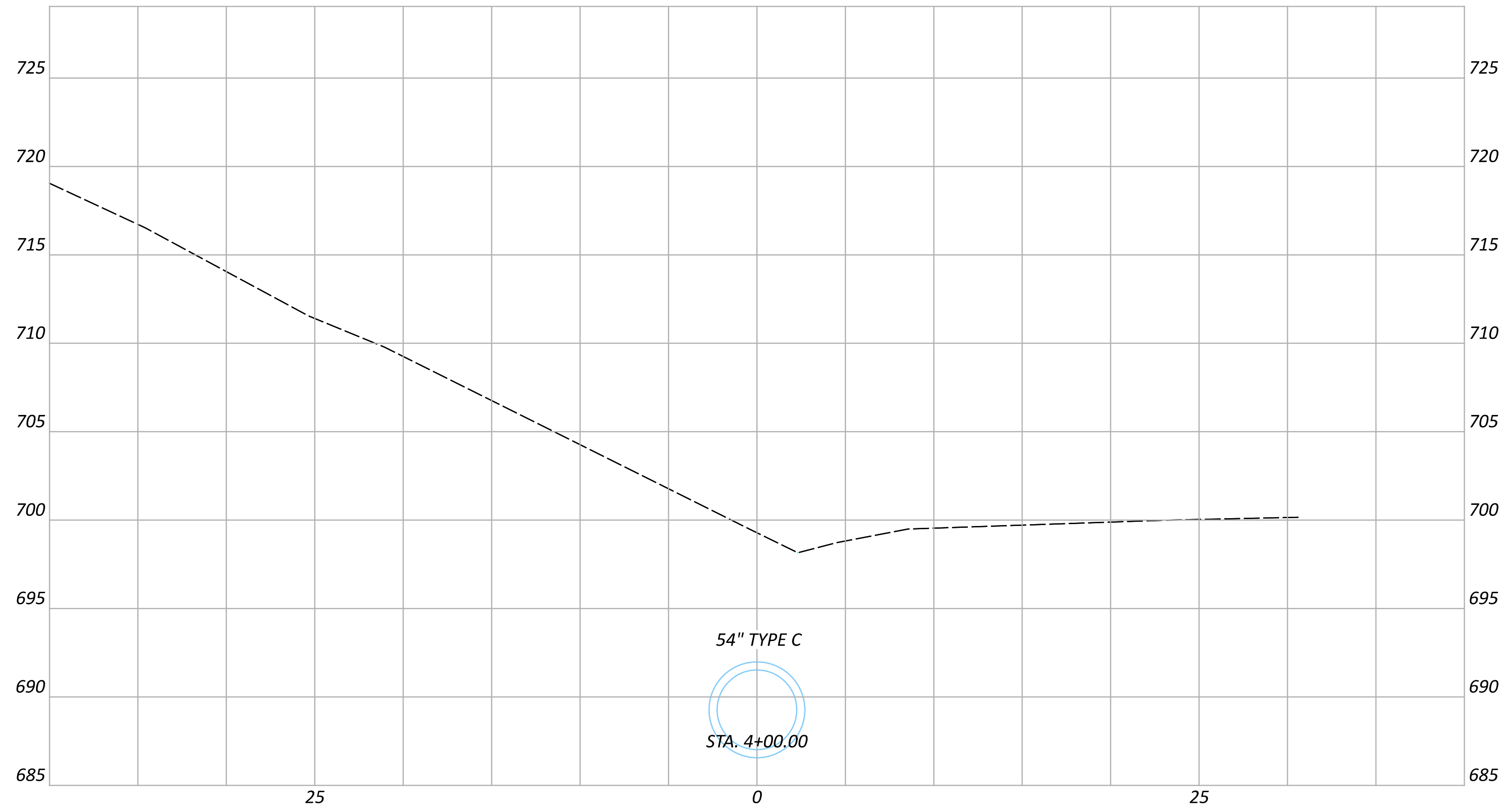

DRAINAGE CROSS SECTIONS
 SUM-271-0850 CULVERT REPLACEMENT

DESIGN AGENCY



DESIGNER

MJP

REVIEWER

TJP 11-09-23

PROJECT ID

93101

Sheet Totals			SHEET	TOTAL
Seeding	Cut	Fill		
			P.13	16

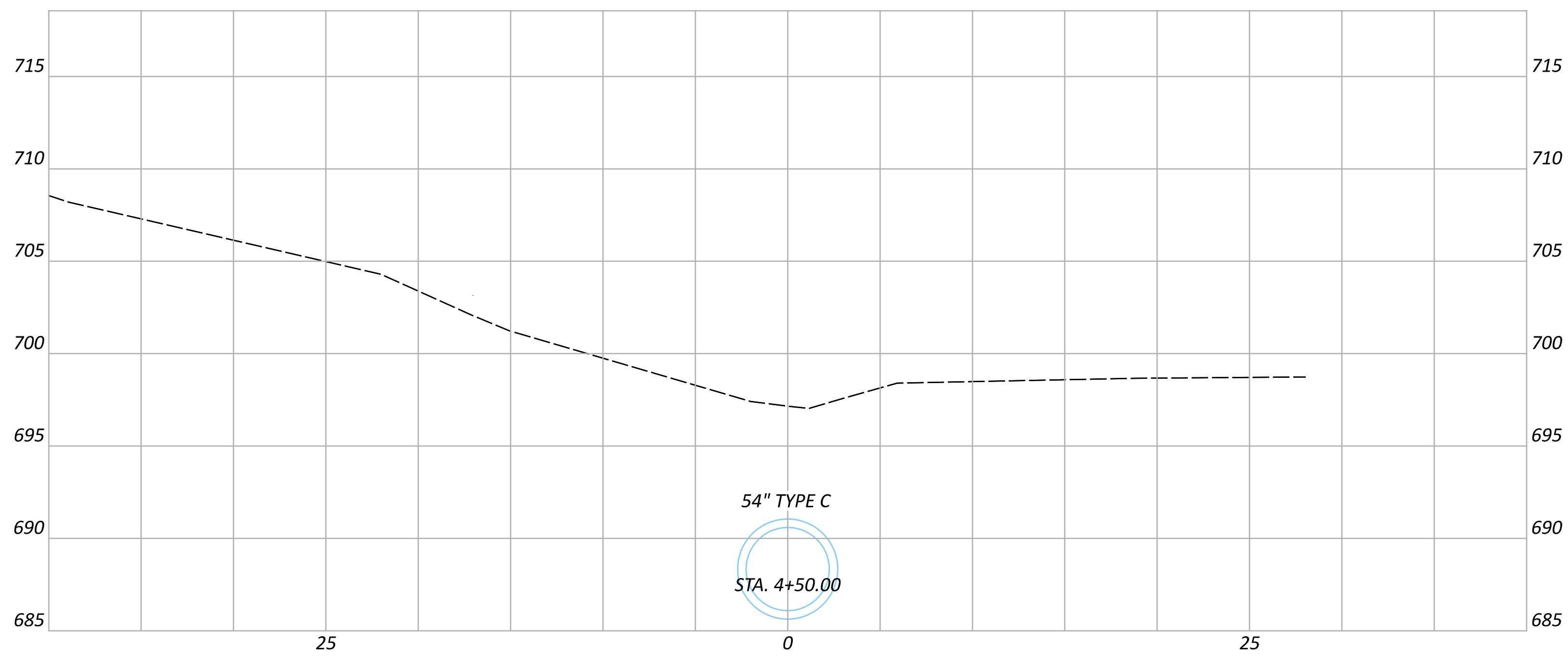
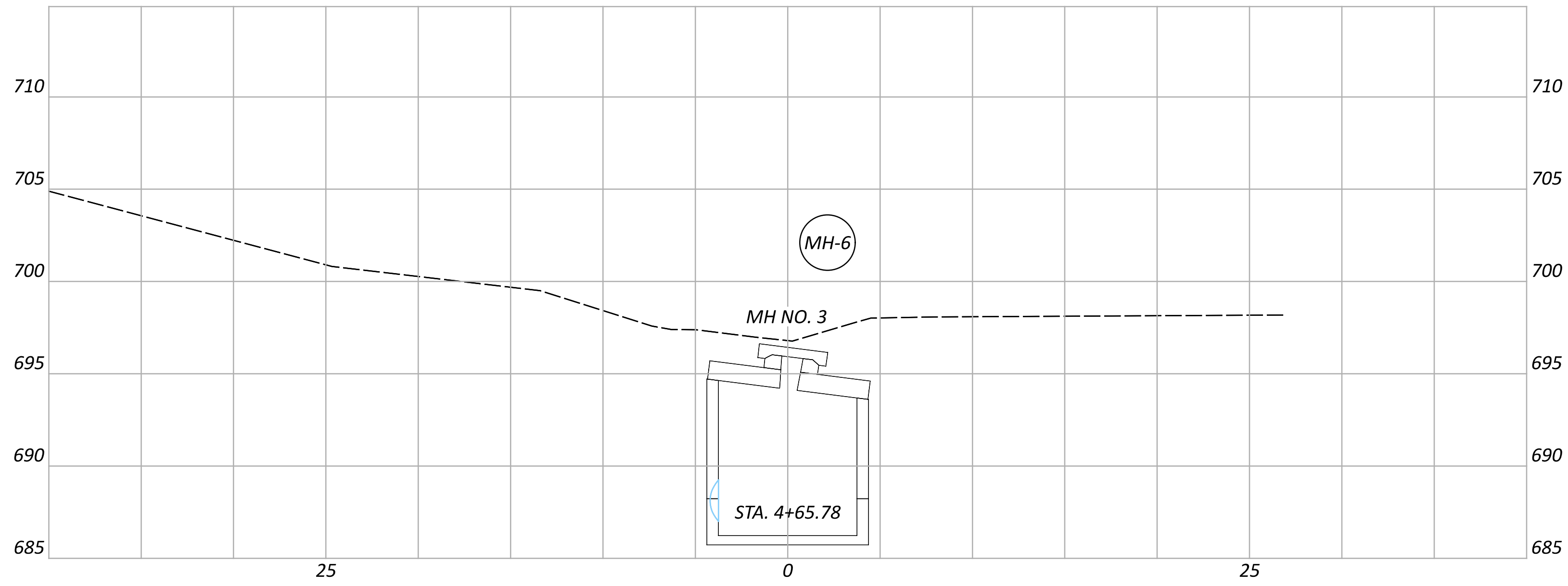

DRAINAGE CROSS SECTIONS
 SUM-271-0850 CULVERT REPLACEMENT

DESIGN AGENCY



DESIGNER

MJP

REVIEWER

TJP 11-09-23

PROJECT ID

93101

Sheet Totals

Seeding	Cut	Fill

SHEET TOTAL

P.14 16

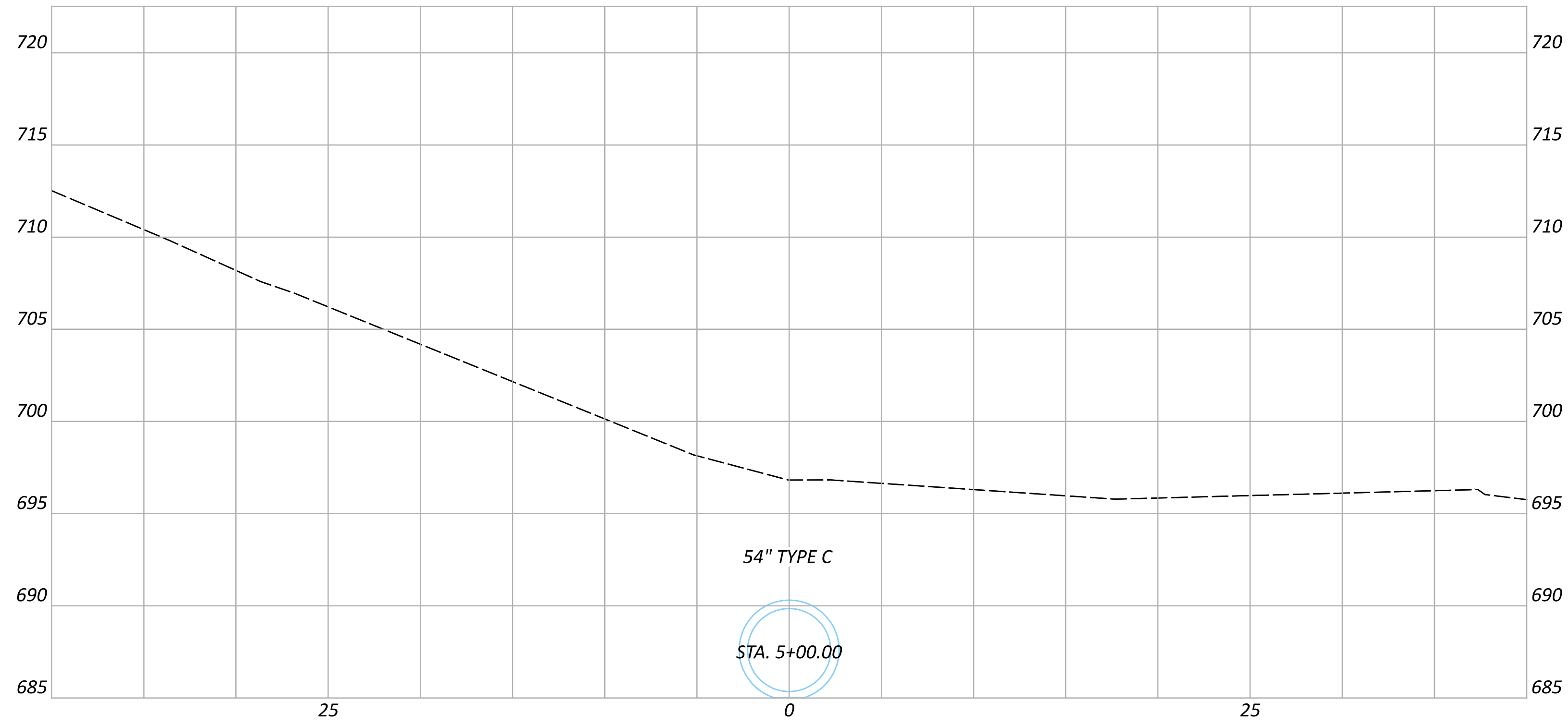
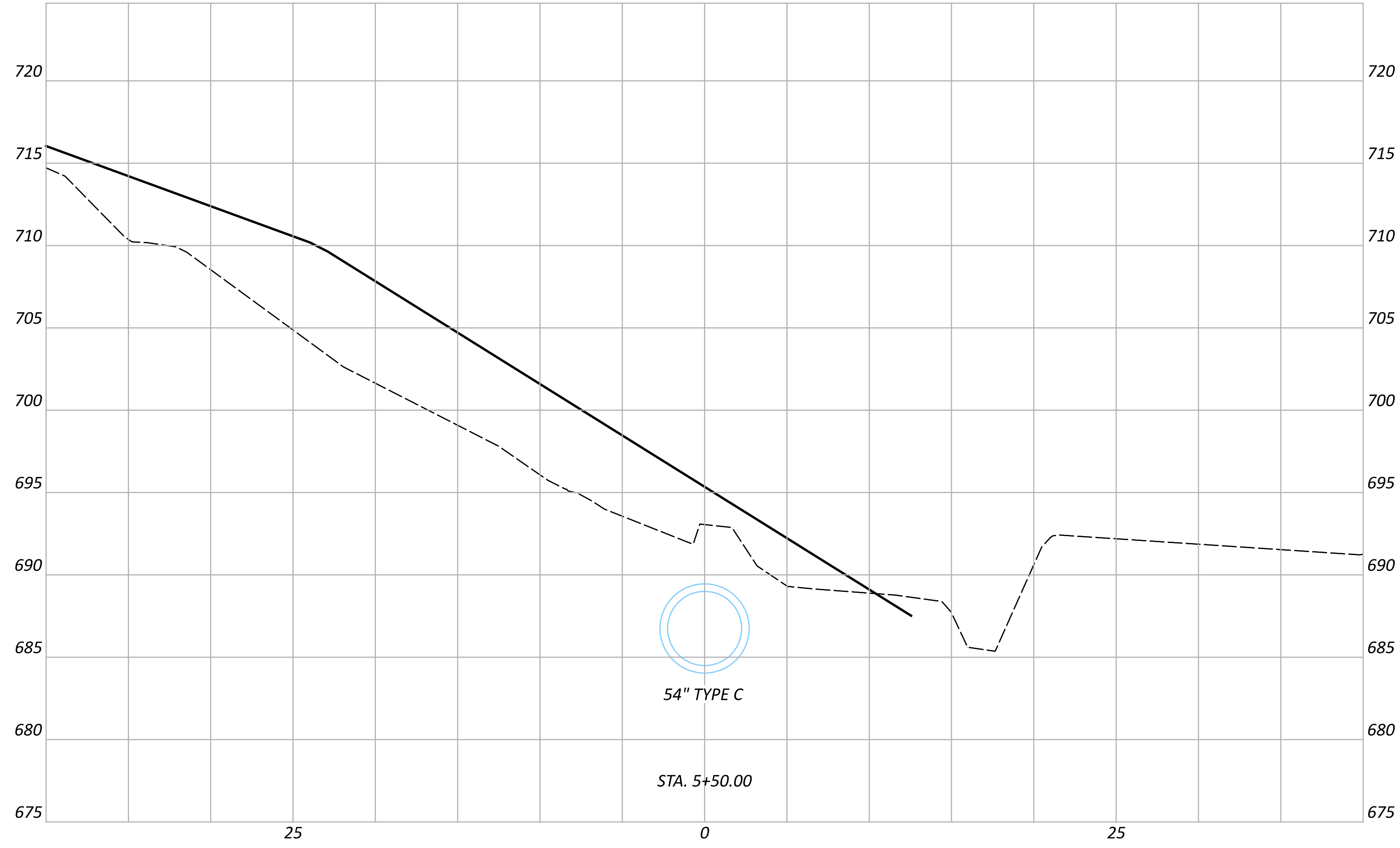

DRAINAGE CROSS SECTIONS
 SUM-271-0850 CULVERT REPLACEMENT

DESIGN AGENCY



DESIGNER

MJP

REVIEWER

TJP 11-09-23

PROJECT ID

93101

Sheet Totals			SHEET	TOTAL
Seeding	Cut	Fill		
			P.15	16

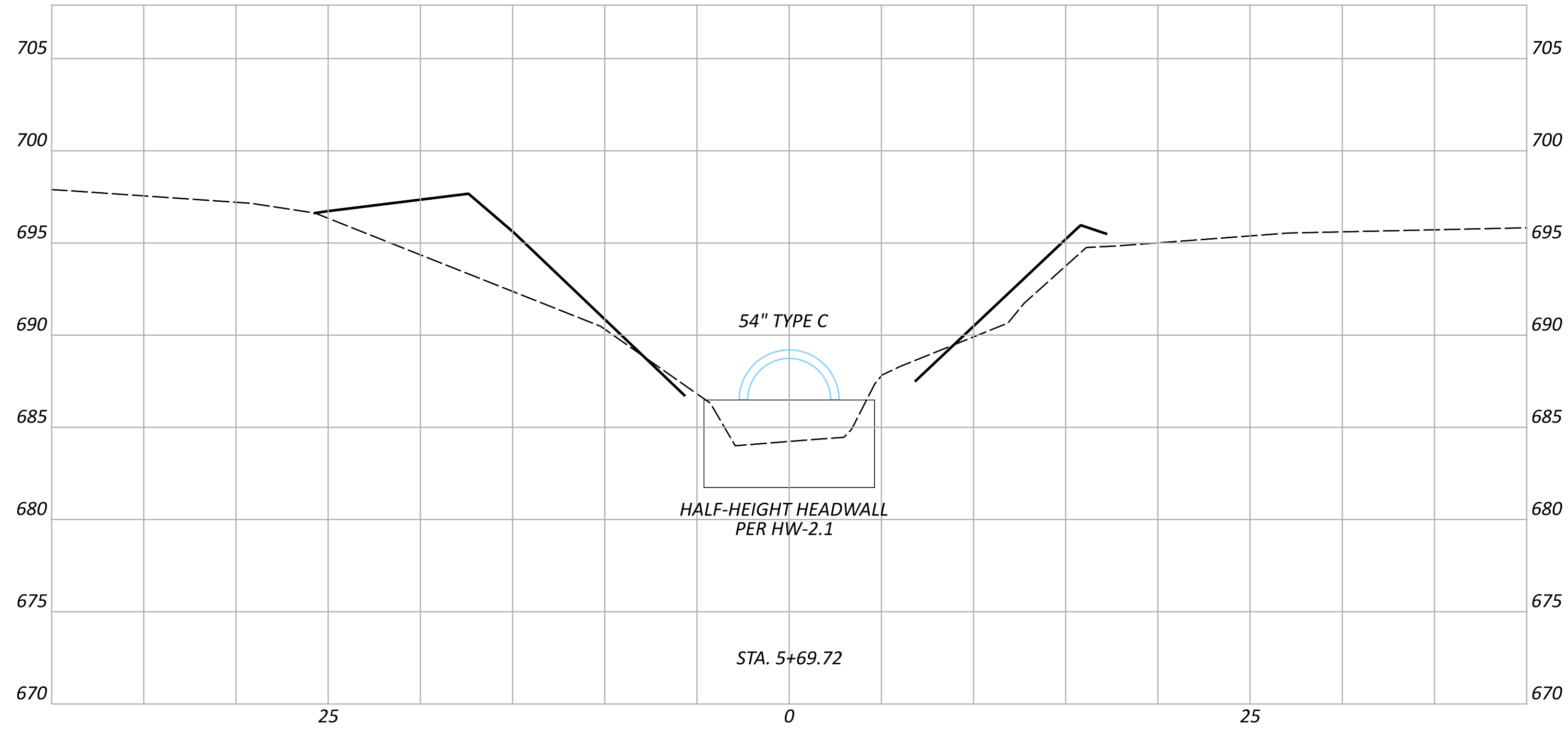

54" TYPE C
 HALF-HEIGHT HEADWALL
 PER HW-2.1

STA. 5+69.72

DRAINAGE CROSS SECTIONS
 SUM-271-0850 CULVERT REPLACEMENT

DESIGN AGENCY	
DESIGNER	MJP
REVIEWER	TJP 11-09-23
PROJECT ID	93101

Sheet Totals			SHEET	TOTAL
Seeding	Cut	Fill	P.16	16